



Intel® Trust Domain Extensions (Intel® TDX) Module Base Architecture Specification

DRAFT

348549-002US

January 2023

Notices and Disclaimers

Intel Corporation (“Intel”) provides these materials as-is, with no express or implied warranties.

All products, dates, and figures specified are preliminary, based on current expectations, and are subject to change without notice. Intel does not guarantee the availability of these interfaces in any future product. Contact your Intel representative to obtain the latest Intel product specifications and roadmaps.

The products described might contain design defects or errors known as errata, which might cause the product to deviate from published specifications. Current, characterized errata are available on request.

Intel technologies might require enabled hardware, software, or service activation. Some results have been estimated or simulated. Your costs and results might vary.

No product or component can be absolutely secure.

You may not use or facilitate the use of this document in connection with any infringement or other legal analysis concerning Intel products described herein. You agree to grant Intel a non-exclusive, royalty-free license to any patent claim thereafter drafted that includes the subject matter disclosed herein.

No license (express, implied, by estoppel, or otherwise) to any intellectual-property rights is granted by this document.

This document contains information on products, services and/or processes in development. All information provided here is subject to change without notice.

Copies of documents that have an order number and are referenced in this document or other Intel literature may be obtained by calling 1-800-548-4725 or by visiting <http://www.intel.com/design/literature.htm>.

© Intel Corporation. Intel, the Intel logo, and other Intel marks are trademarks of Intel Corporation or its subsidiaries. Other names and brands might be claimed as the property of others.

DRAFT

Table of Contents

	SECTION 1: INTRODUCTION AND OVERVIEW.....	11
	1. About this Document.....	12
	1.1. Scope of this Document	12
5	1.2. Document Organization.....	12
	1.3. Glossary.....	13
	1.4. Notation.....	16
	1.4.1. Requirement and Definition Commitment Levels	16
	1.5. References.....	16
10	1.5.1. Intel Public Documents	16
	1.5.2. Intel TDX Public Documents.....	17
	2. Overview of Intel® Trust Domain Extensions.....	18
	2.1. Intel TDX Module Lifecycle	18
	2.1.1. Boot-Time Configuration and Intel TDX Module Loading.....	18
15	2.1.2. UPDATED: Intel TDX Module Initialization, Enumeration and Configuration	18
	2.2. Guest TD Life Cycle Overview	19
	2.2.1. Guest TD Build.....	19
	2.2.2. Guest TD Execution.....	19
	2.2.3. Guest TD Management during its Run-Time.....	19
20	2.3. Intel TDX Operation Modes and Transitions	20
	2.4. Guest TD Private Memory Protection	21
	2.4.1.1. Memory Encryption	21
	2.4.2. Address Translation	21
	2.5. Guest TD State Protection	22
25	2.6. Intel TDX I/O Model.....	22
	2.7. Measurement and Attestation.....	23
	2.8. Intel TDX Managed Control Structures	23
	2.9. Intel TDX Interface Functions	24
	2.9.1. Host-Side (SEAMCALL Leaf) Interface Functions.....	24
30	2.9.2. Guest-Side (TDCALL Leaf) Interface Functions.....	26
	3. Software Use Cases.....	28
	3.1. Intel TDX Module Lifecycle	28
	3.1.1. UPDATED: Intel TDX Module Platform-Scope First-Time Initialization	28
	3.1.2. UPDATED: Intel TDX Module Shutdown and Update.....	28
35	3.1.2.1. Intel TDX Module Reload	29
	3.1.2.2. Intel TDX Module Update	29
	3.2. TD Build.....	29
	3.3. TD Run Time	31
	3.3.1. Private Memory Management.....	31
40	3.3.1.1. Dynamic Page Addition (Shared to Private Conversion).....	31
	3.3.1.2. Dynamic Page Removal (Private to Shared Conversion).....	32
	3.3.1.3. Page Promotion (Mapping Merge)	34
	3.3.1.4. Page Demotion (Mapping Split).....	35
	3.3.1.5. GPA Range Unblock.....	36
45	3.3.2. Guest TD Execution	36
	3.3.2.1. TD VCPU First-Time Invocation	36
	3.3.2.2. TD VCPU Entry, Exit on TDG.VP.VMCALL and Re-Entry.....	37

	3.3.2.3.	TD VCPU Entry, Exit on Asynchronous Event and Re-Entry	37
	3.3.2.4.	Guest-Side Functions	38
	3.3.2.5.	TD VCPU Rescheduling (Migration to Another LP).....	39
	3.4.	TD Destruction	40
5		SECTION 2: INTEL TDX MODULE ARCHITECTURE SPECIFICATION	42
	4.	UPDATED: Intel TDX Module Lifecycle: Enumeration, Initialization and Shutdown	43
	4.1.	UPDATED: Overview.....	43
	4.1.1.	UPDATED: Intel TDX Module Lifecycle State Machine	43
	4.1.2.	Platform Compatibility and Configuration Checking	44
10	4.1.2.1.	Overview	44
	4.1.2.2.	CPU Configuration.....	44
	4.1.2.3.	MSR Sampling and Checks	44
	4.1.2.4.	UPDATED: CPUID Sampling, Checks and Enumeration	44
	4.1.3.	Physical Memory Configuration Overview.....	45
15	4.1.3.1.	Intel TDX ISA Background: Convertible Memory Ranges (CMRs)	45
	4.1.3.2.	TDMRs and PAMT Arrays Configuration	45
	4.2.	Intel TDX Module Initialization Interface	47
	4.2.1.	Global Initialization: TDH.SYS.INIT	47
	4.2.2.	LP-Scope Initialization: TDH.SYS.LP.INIT	47
20	4.2.3.	UPDATED: TDX Module Enumeration: TDH.SYS.RD/RDALL and TDH.SYS.INFO	47
	4.2.4.	Global Configuration: TDH.SYS.CONFIG	48
	4.2.5.	Package-Scope Key Configuration: TDH.SYS.KEY.CONFIG.....	48
	4.2.6.	State Restoration after TD-Preserving TDX Module Update: TDH.SYS.UPDATE	48
	4.3.	TDMR and PAMT Initialization	48
25	4.4.	Intel TDX Module Shutdown	49
	4.4.1.	Shutdown Initiated by the Host VMM (as Part of Module Update)	49
	4.4.2.	Shutdown Initiated by a Fatal Error	49
	4.5.	Intel TDX Module Handoff Data	49
	5.	Memory Encryption Key Management.....	51
30	5.1.	Objectives.....	51
	5.2.	Background: HKID Space Partitioning	51
	5.3.	Key Management Tables	52
	5.4.	Combined Key Management State	53
	5.5.	Key Management Sequences	54
35	5.5.1.	Intel TDX Module Initialization: Setting an Ephemeral Key and Reserving an HKID for Intel TDX Data	54
	5.5.2.	TD Creation, Keys Assignment and Configuration	54
	5.5.3.	TD Keys Reclamation, TLB and Cache Flush	55
	6.	UPDATED: TD Non-Memory State (Metadata) and Control Structures	56
	6.1.	Overview	56
40	6.1.1.	Opaque vs. Private vs. Shared Control Structures	56
	6.1.2.	Scope of Control Structures	56
	6.2.	TD-Scope Control Structures	56
	6.2.1.	TDR (Trust Domain Root)	57
	6.2.2.	UPDATED: TDCS (Trust Domain Control Structure).....	57
45	6.3.	TD VCPU-Scope Control Structures	57
	6.3.1.	Trust Domain Virtual Processor State (TDVPS)	57
	6.3.1.1.	UPDATED: Physical View of TDVPS: TDVPR/TDCX.....	58
	6.3.1.2.	Logical View of TDVPS.....	58
	6.3.2.	Non-Protected Control Structures: Shared EPT and VMCS Auxiliary Control Structures	59

	6.4.	<i>Updated:</i> TD Non-Memory State (Metadata) Access Functions	59
	6.5.	Concurrency Restrictions and Enforcement	59
	7.	UPDATED: TD Life Cycle Management.....	60
	7.1.	TD Life Cycle State Machine.....	60
5	7.2.	<i>Updated:</i> OP_STATE: TD Operation Secondary-Level State Machine.....	60
	7.3.	TD Creation Sequence	61
	7.4.	VCPU Creation and Initialization Sequence.....	62
	7.5.	TD Teardown Sequence.....	63
	8.	Physical Memory Management	64
10	8.1.	<i>Updated:</i> Trust Domain Memory Regions (TDMRs) and Physical Address Metadata Tables (PAMTs)	64
	8.2.	<i>Updated:</i> TDMR Details.....	64
	8.3.	PAMT Details.....	64
	8.3.1.	PAMT Entry	64
	8.3.2.	PAMT Blocks and PAMT Arrays.....	65
15	8.3.3.	PAMT Page Types.....	66
	8.3.4.	PAMT Hierarchy	66
	8.4.	Adding Physical Pages.....	67
	8.4.1.	Preventing Cache Line Aliasing	67
	8.4.2.	Adding Pages not Mapped to the Guest TD.....	67
20	8.4.3.	Adding Pages and Mapping to the Guest TD's GPA	67
	8.5.	Reclaiming Physical Pages	67
	8.5.1.	Required Cache Flush and Initialization by the Host VMM.....	67
	8.5.2.	Reclaiming Pages not Mapped to the Guest TD	68
	8.5.3.	Reclaiming TD Pages in TD_TEARDOWN State	68
25	8.5.4.	Reclaiming Physical Pages as Part of TD Private Memory Management.....	68
	9.	TD Private Memory Management.....	69
	9.1.	Overview	69
	9.2.	Secure EPT Entry	70
	9.2.1.	<i>Updated:</i> Overview	70
30	9.2.2.	<i>Updated:</i> SEPT Entry State Diagrams	71
	9.3.	Secure EPT Walk.....	72
	9.4.	<i>Updated:</i> Secure EPT Induced TD Exits	72
	9.5.	<i>Updated:</i> Secure EPT Induced Exceptions.....	73
	9.6.	<i>Updated:</i> Secure EPT Concurrency	73
35	9.7.	Introduction to TLB Tracking.....	73
	9.8.	Secure EPT Build and Update: TDH.MEM.SEPT.ADD.....	74
	9.9.	Adding TD Private Pages during TD Build Time: TDH.MEM.PAGE.ADD	75
	9.10.	Dynamically Adding TD Private Pages	76
	9.10.1.	Overview	76
40	9.10.2.	Page Addition by the Host VMM: TDH.MEM.PAGE.AUG	77
	9.10.3.	Page Acceptance by the Guest TD: TDG.MEM.PAGE.ACCEPT.....	78
	9.10.3.1.	Description	78
	9.10.3.2.	TDG.MEM.PAGE.ACCEPT Concurrency	79
	9.11.	Page Merge: TDH.MEM.PAGE.PROMOTE	80
45	9.12.	Page Split: TDH.MEM.PAGE.DEMOTE.....	81

	9.13.	Relocating TD Private Pages: <i>TDH.MEM.PAGE.RELOCATE</i>	82
	9.14.	Removing TD Private Pages: <i>TDH.MEM.PAGE.REMOVE</i>	83
	9.15.	Removing a Secure EPT Page: <i>TDH.MEM.SEPT.REMOVE</i>	83
	9.16.	Unblocking a GPA Range: <i>TDH.MEM.RANGE.UNBLOCK</i>	84
5	10.	TD VCPU	85
	10.1.	UPDATED: <i>VCPU Transitions</i>	85
	10.1.1.	Initial TD Entry, Asynchronous TD Exit and Subsequent TD Entry	85
	10.1.2.	Synchronous TD Exit and Subsequent TD Entry	86
	10.1.3.	UPDATED: <i>VCPU Activity State Machine</i>	86
10	10.2.	UPDATED: <i>TD VCPU TLB Address Space Identifier (ASID)</i>	88
	10.2.1.	UPDATED: <i>TD ASID Components</i>	88
	10.2.2.	UPDATED: <i>INVEPT by the Host VMM for Managing the Shared EPT</i>	88
	10.3.	<i>VCPU-to-LP Association</i>	89
	10.3.1.	Non-Coherent Caching.....	89
15	10.3.2.	Intel TDX Functions for VCPU-LP Association and Dis-Association	89
	10.3.3.	Performance Considerations	89
	11.	UPDATED: CPU Virtualization (Non-Root Mode Operation)	90
	11.1.	<i>Initial State</i>	90
	11.1.1.	Overview	90
20	11.1.2.	Initial State of Guest TD GPRs	90
	11.1.3.	Initial State of CRs	90
	11.1.4.	Initial State of Segment Registers	91
	11.1.5.	Initial State of MSRs	91
	11.2.	UPDATED: <i>Guest TD Run Time Environment Enumeration</i>	91
25	11.3.	<i>CPU Mode Restrictions</i>	92
	11.4.	<i>Instructions Restrictions</i>	92
	11.4.1.	Unconditionally Blocked Instructions	92
	11.4.1.1.	Instructions that Cause a #UD Unconditionally	92
	11.4.1.2.	Instructions that Cause a #VE Unconditionally	92
30	11.4.1.3.	Instructions that Cause a #UD or #VE Depending on Feature Enabling.....	93
	11.4.1.4.	Other Cases of Unconditionally Blocked Instructions	93
	11.4.2.	Conditionally Blocked Instructions	93
	11.4.3.	Other Exception Cases	93
	11.5.	<i>Extended Feature Set</i>	93
35	11.5.1.	Allowed Extended Features Control	93
	11.5.2.	Extended State Isolation	93
	11.5.3.	Extended Features Execution Control.....	93
	11.6.	UPDATED: <i>CR Handling</i>	96
	11.6.1.	CR0	96
40	11.6.2.	UPDATED: CR4	96
	11.7.	<i>MSR Handling</i>	97
	11.7.1.	Overview	97
	11.7.2.	NEW: <i>MSR Configuration by the Host VMM</i>	97
	11.8.	UPDATED: <i>CPUID Virtualization</i>	98
45	11.8.1.	UPDATED: <i>CPUID Configuration by the Host VMM</i>	98
	11.8.2.	Guest TD Control of CPUID Virtualization	99
	11.8.2.1.	Unconditional #VE for all CPUID Leaves and Sub-Leaves.....	99
	11.8.2.2.	NEW: <i>Leaf/Sub-leaf Specific Control</i>	99
	11.8.3.	NEW: <i>CPUID Configuration & Checks at Guest TD Migration</i>	99
50	11.9.	<i>Interrupt Handling and APIC Virtualization</i>	99

	11.9.1.	Virtual APIC Mode.....	99
	11.9.2.	Virtual APIC Access by Guest TD	99
	11.9.3.	Implicit APIC Write #VE.....	101
	11.9.4.	UPDATED: Posted Interrupts.....	101
5	11.9.5.	Pending Virtual Interrupt Delivery Indication	102
	11.9.6.	Cross-TD-VCPU IPI.....	102
	11.9.7.	Virtual NMI Injection.....	102
	11.10.	<i>Virtualization Exception (#VE)</i>	102
	11.10.1.	Virtualization Exception Information	102
10	11.10.2.	#VE Injection by the CPU due to EPT Violations	103
	11.10.3.	#VE Injected by the Intel TDX Module	104
	11.11.	<i>Secure and Shared Extended Page Tables (EPTs)</i>	104
	11.11.1.	GPAW-Relate EPT Violations.....	104
	11.11.2.	EPT Violation Mutated into #VE.....	104
15	11.12.	<i>Prevention of TD-Induced Denial of Service</i>	104
	11.12.1.	Bus Lock Detection by the TD OS	104
	11.12.2.	Impact of MSR_TEST_CTRL (MSR 0x33)	104
	11.12.3.	Bus Lock TD Exit	105
	11.12.4.	Notification TD Exit	105
20	11.13.	<i>Time Stamp Counter (TSC)</i>	105
	11.13.1.	TSC Virtualization	105
	11.13.2.	TSC Deadline	106
	11.14.	<i>Supervisor Protection Keys (PKS)</i>	106
	11.15.	<i>Intel® Total Memory Encryption (Intel® TME) and Multi-Key Total Memory Encryption (MKTME)</i>	106
25	11.15.1.	TME Virtualization.....	106
	11.15.2.	MKTME Virtualization	106
	11.16.	<i>Virtualization of Machine Check Capabilities and Controls</i>	107
	11.17.	<i>Transactional Synchronization Extensions (TSX)</i>	107
	11.18.	<i>Other Changes in SEAM Non-Root Mode</i>	107
30	11.18.1.	Tasking	107
	11.18.2.	PAUSE-Loop Exiting.....	107
	12.	Measurement and Attestation	109
	12.1.	<i>TD Measurement</i>	109
	12.1.1.	MRTD: Build-Time Measurement Register	109
35	12.1.2.	RTMR: Run-Time Measurement Registers	109
	12.2.	UPDATED: <i>TD Measurement Reporting</i>	109
	12.3.	<i>Local Report Verification</i>	110
	12.4.	<i>TD Measurement Quoting</i>	111
	12.4.1.	Intel SGX-Based Attestation.....	111
40	12.5.	<i>Quote Signing Key</i>	111
	12.6.	<i>TCB Recovery</i>	112
	13.	NEW: Service TDs	113
	13.1.	<i>Overview</i>	113
	13.2.	<i>Service TD Binding</i>	113
45	13.2.1.	Service TD Binding Table in the Target TD's TDCS	113
	13.2.2.	SERVTD_BINDING_STATE: Service TD Binding State.....	114
	13.2.3.	SERVTD_TYPE: Service TD Binding Type.....	114
	13.2.4.	SERVTD_ATTR: Service TD Binding Attributes.....	114
	13.2.4.1.	INSTANCE_BINDING: Class vs. Instance Binding	114

	13.2.4.2.	MIGRATABLE_BINDING: Binding Migratability	115
	13.2.4.3.	IGNORE_TDINFO: TDINFO Component Filtering	115
	13.2.5.	SERVTD_UUID: Service TD Instance Identifier	115
	13.2.6.	Service TD's Binding SERVTD_INFO_HASH Calculation	115
5	13.2.7.	Target TD's SERVTD_HASH Calculation	115
	13.2.7.1.	SERVTD_HASH Calculation of Finalization of TD Build	116
	13.2.7.2.	SERVTD_HASH Calculation on TD Import	116
	13.2.7.3.	SERVTD_HASH Calculation Method	116
	13.2.8.	TDH.SERVTD.PREBIND: Pre-Binding a Service TD	116
10	13.2.9.	TDH.SERVTD.BIND: Binding a Service TD	117
	13.2.10.	Binding Handle	117
	13.3.	Target TD Metadata Access by a Service TD	117
	13.3.1.	TDG.SERVTD.RD/WR: Metadata Read/Write Interface Functions	117
	13.3.2.	Metadata Access Error Handling	118
15	13.3.3.	Cross-TD Concurrency Handling: Maintaining Host-Side Priority	118
	13.3.3.1.	Problem Description	118
	13.3.3.2.	Solution	119
	14.	I/O Support	120
	14.1.	Overview	120
20	14.2.	Paravirtualized I/O	120
	14.3.	MMIO Emulation and Emulated Devices	120
	14.4.	Direct Device Assignment (DDA) and SRIOV	120
	14.5.	IOMMU – DMA Remapping	120
	14.6.	Shared Virtual Memory (SVM)	121
25	15.	Debug and Profiling Architecture	122
	15.1.	On-TD Debug	122
	15.1.1.	Overview	122
	15.1.2.	Generic Debug Handling	122
	15.1.2.1.	Context Switch	122
30	15.1.2.2.	IA32_DEBUGCTL MSR Virtualization	122
	15.1.3.	Debug Feature-Specific Handling	123
	15.2.	On-TD Performance Monitoring	124
	15.2.1.	Overview	124
	15.2.2.	Performance Monitoring MSRs	124
35	15.2.3.	Performance Monitoring Interrupts (PMIs)	125
	15.3.	Off-TD Debug	125
	15.3.1.	Modifying Debuggable TD's State, Controls and Memory	126
	15.3.2.	Preventing Guest TD Corruption of DRs	126
	15.4.	Uncore Performance Monitoring Interrupts (Uncore PMIs)	126
40	16.	Memory Integrity Protection and Machine Check Handling	127
	16.1.	Overview	127
	16.2.	TDX Memory Integrity Protection Background	127
	16.2.1.	Cryptographic Integrity (Ci) vs. Logical Integrity (Li), MAC and TD Owner	127
	16.2.2.	MAC and TD Owner Update on Memory Writes	127
45	16.2.3.	Memory Reads: Integrity and TD Owner Bit Checks, Poison Generation and Poison Consumption	128
	16.2.4.	Memory Writes: No Integrity nor TD Owner Bit Checks	130
	16.3.	Machine Check Architecture (MCA) Background	130
	16.3.1.	Uncorrected Machine Check Error	130
	16.3.2.	Corrected Machine Check Interrupt (CMCI)	130
50	16.3.3.	Machine Check System Management Interrupt (MSMI)	130

	16.3.4.	Local Machine Check Event (LMCE)	130
	16.4.	<i>Recommended MCA Platform Configuration for TDX</i>	131
	16.5.	<i>Handling Machine Check Events during Guest TD Operation</i>	131
5	16.5.1.	Machine Check Events Delivered as an #MC Exception (Recommended)	131
	16.5.2.	Machine Check Events Delivered as an MSMI (Not Recommended)	132
	16.5.3.	LMCE Disabled (Not Recommended)	133
	16.5.4.	Machine Check Events Delivered as a CMCI	133
	16.6.	<i>Handling MCE during Intel TDX Module Operation</i>	133
	17.	UPDATED: Side Channel Attack Mitigation Mechanisms	134
10	17.1.	UPDATED: Checking and Virtualization of CPU Side Channel Protection Mechanisms Enumeration	134
	17.1.1.	IA32_ARCH_CAPABILITIES MSR	134
	17.1.2.	CPUID	135
	17.2.	UPDATED: Branch Prediction Side Channel Attacks Mitigation Mechanisms	135
	17.3.	UPDATED: Single-Step and Zero-Step Attacks Mitigation Mechanisms	135
15	17.3.1.	UPDATED: Description	135
	17.3.2.	UPDATED: Host VMM Expected Behavior	136
	17.3.3.	UPDATED: Guest TD Interface and Expected Guest TD Operation	136
	18.	UPDATED: General Aspects of the Intel TDX Interface Functions	138
	18.1.	<i>Concurrency Restrictions and Enforcement</i>	138
20	18.1.1.	Explicit Concurrency Restrictions	138
	18.1.2.	Implicit Concurrency Restrictions	138
	18.1.3.	Transactions	139
	18.1.4.	NEW: Concurrency Restrictions with Host Priority	139
25	18.1.4.1.	Overview	139
	18.1.4.2.	Host-Side (SEAMCALL) Operation	139
	18.1.4.3.	Guest-Side (TDCALL) Operation	139
	18.1.4.4.	Host Priority Busy Timeout	139
	18.2.	<i>Memory and Resource Operands Access</i>	140
	18.2.1.	Overview	140
30	18.2.1.1.	Access Semantics	140
	18.2.1.2.	Explicit vs. Implicit Access	140
	18.2.1.3.	Memory Operand Address Specification	141
	18.2.1.4.	Memory Type	141
	18.2.1.5.	Actual Memory Access vs. Memory Reference	141
35	18.2.1.6.	Summary Table	142
	18.3.	UPDATED: Register Operands and CPU State Convention	142
	18.3.1.	Overview: Regular vs. Transition Leaf Functions	142
	18.3.2.	NEW: Interface Function Leaf and Version Numbers	142
	18.3.3.	CPU State Preservation Convention	143
40	18.3.3.1.	TDH.VP.ENTER	143
	18.3.3.2.	Other Interface Functions	143
	18.3.4.	Transition Cases: TD Entry and Exit	143
	18.3.4.1.	TD Entry: TDH.VP.ENTER	143
	18.3.4.2.	TD Synchronous Exit: TDG.VP.VMCALL	144
45	18.4.	UPDATED: Interface Function Completion Status	144
	18.4.1.	Least Detailed Level: Success/Warning/Error	144
	18.4.2.	UPDATED: Medium Detailed Level: Class, Recoverability and Fatality	144
	18.4.3.	UPDATED: Most Detailed Level	145
	18.5.	NEW: TD, VM and VCPU Identification	145
50	18.6.	UPDATED: Metadata Access Interface	145
	18.6.1.	Introduction	145
	18.6.2.	Metadata Fields and Elements	146

	18.6.3. Arrays of Metadata Fields	146
	18.6.4. NEW: Metadata Field Sequences	147
	18.6.5. NEW: Metadata Lists	148
	18.7. <i>Latency of the Intel TDX Interface Functions</i>	149
5	18.8. <i>DRNG Entropy Errors</i>	149

DRAFT

SECTION 1: INTRODUCTION AND OVERVIEW

DRAFT

1. About this Document

1.1. Scope of this Document

This document describes the architecture of the Intel® Trust Domain Extensions (Intel® TDX) module, implemented using the Intel TDX Instruction Set Architecture (ISA) extensions, for confidential execution of Trust Domains in an untrusted hosted cloud environment.

This document is part of the **TDX Module Architecture Specification Set**, which includes the following documents:

Table 1.1: TDX Module Architecture Specification Set

Document Name	Reference	Description
TDX Module Base Architecture Specification	[TDX Module Base Spec]	Base TDX module architecture overview and specification, covering key management, TD lifecycle management, memory management, virtualization, measurement and attestation, service TDs, debug aspects etc.
TDX Module TD Migration Architecture Specification	[TD Migration Spec]	Architecture overview and specification for TD migration
TDX Module TD Partitioning Architecture Specification	[TD Partitioning Spec]	Architecture overview and specification for TD Partitioning
TDX Module ABI Reference Specification	[TDX Module ABI Spec]	Detailed TDX module Application Binary Interface (ABI) reference specification, covering the entire TDX module architecture
TDX Module ABI Incompatibilities between TDX 1.0 and TDX 1.4/1.5	[TDX Module ABI Incompatibilities]	Description of the incompatibilities between TDX 1.0 and TDX 1.4/1.5 that may impact the host VMM and/or guest TDs

This document is a work in progress and is subject to change based on customer feedback and internal analysis. This document does not imply any product commitment from Intel to anything in terms of features and/or behaviors.

Note: The contents of this document are accurate to the best of Intel’s knowledge as of the date of publication, though Intel does not represent that such information will remain as described indefinitely in light of future research and design implementations. Intel does not commit to update this document in real time when such changes occur.

1.2. Document Organization

The document has the following main sections:

- Section 1 contains an introduction to the document and an overview of the Intel TDX module.
- Section 2 contains the Intel TDX module architecture specification.

1.3. Glossary

Table 1.2: Intel TDX Glossary

Acronym	Full Name	New for TDX	Description
ABI	Application Binary Interface	No	A programming interface defined at the binary level (i.e., instruction opcode and CPU registers). The Intel TDX module interface is specified as an ABI.
ACM	Authenticated Code Module	No	A code module that is designed to be loaded, verified and executed by the CPU in on-chip memory (CRAM).
N/A	Accessible (Memory)	No	Memory whose content is readable and/or writeable (e.g., TD private memory is accessible to the guest TD).
N/A	Addressable (Memory)	No	Memory that can be referred to by its address. The content of addressable memory might not necessarily be accessible (e.g., TDCS is not accessible to the host VMM).
CMR	Convertible Memory Range	Yes	A range of physical memory configured by BIOS and verified by MCHECK. MCHECK verification is intended to help ensure that a CMR may be used to hold TDX memory pages encrypted with a private HKID.
N/A	Enlightened OS	No	A TD OS is considered enlightened if it is aware that it is running as a TD (see Paravirtualization).
EPxE	Extended Paging Structures Cache	No	The CPU's cache of EPT intermediate translations (as opposed to TLB, which caches full LA or GPA to HPA translations).
GPA	Guest Physical Address	No	An address viewed as a physical address, from a guest VM's point of view. A GPA is subject to further translation (by EPT) to produce an HPA.
N/A	Hidden	No	A resource or a data structure that is not directly addressable by software (except the Intel TDX module).
HKID	Host Key ID	Yes	When MKTME is activated, HKID is a key identifier for an encryption key used by one or more memory controllers on the platform.
N/A	Host VMM	Yes	The VMM that serves as a host to guest TDs. The term "host" is used to differentiate between the "host VMM" and future VMMs that may be nested within TDs.
HPA	Host Physical Address	No	A physical address at the host VMM level. This is the actual physical address used by the hardware (e.g., caches). See also PA.
KET	Key Encryption Table	Yes	A table held by each MKTME encryption engine, intended for holding encryption key information, indexed by HKID.
KOT	Key Ownership Table	Yes	An internal, hidden table held by the Intel TDX module, intended for controlling the assignment of HKIDs to TDs.
MBZ	Must Be Zero	No	Normally used to indicate that reserved fields must contain 0.

Acronym	Full Name	New for TDX	Description
MKTME	Multi-Key TME	No	This SoC capability adds support to the TME to allow software to use one or more separate keys for encryption of volatile or persistent memory encryption. When used with TDX, it can provide confidentiality via separate keys for memory used by TDs. MKTME can be used with and without TDX extensions. ¹
MRTD	Measurement of Trust Domain	Yes	The SHA-384 measurement of a TD accumulated during TD build.
NP-SEAMLDR	Non-Persistent SEAM Loader	Yes	An ACM intended to load an Intel P-SEAMLDR module into the SEAM range.
P-SEAMLDR	Persistent SEAM Loader	Yes	A SEAM module intended to install (load or update) Intel TDX modules into SEAM range.
PA	Physical Address	No	The physical address used by the hardware (e.g., caches). See also HPA.
PAMT	Physical Address Metadata Table	Yes	An internal, hidden data structure used by the Intel TDX module, which is intended to hold the metadata of physical pages.
PV	Para-Virtualization	No	A virtualization technique where the VM can be aware it is being virtualized (as opposed to running directly on hardware).
RTMR	Run-Time Measurement Register	Yes	A SHA-384 measurement register that can be updated during TD run-time.
SEAM	Secure Arbitration Mode	Yes	See TDX ISA.
SEAMRR	SEAM Range Register	Yes	A range register used by the BIOS to help configure the SEAM memory range, where the Intel TDX module is loaded and executed.
Service TD	Service TD	Yes	A Trust Domain (TD) VM used to provide a dedicated service/utility. Extends the TCB of the tenant TD it provides the service to. Migration TD (MigTD) is an example Service TD.
SEPT	Secure EPT	Yes	An Extended Page Table for GPA-to-HPA translation of TD private HPA. A Secure EPT is designed to be encrypted with the TD's ephemeral private key. SEPT pages are allocated by the host VMM via Intel TDX functions, but their content is intended to be hidden and is not architectural.
Intel® SGX	Intel® Software Guard Extensions	No	An Intel CPU mode and ISA extensions that support operation and management of Intel® SGX enclaves.
SoC	System on Chip	No	A whole system, including cores, uncore, interconnects etc., packaged as a single device.

¹ In this document, the term “MK-TME” is used to mean both the feature and the encryption engine itself.

Acronym	Full Name	New for TDX	Description
SPA	System Physical Address	No	The physical address used by the hardware (e.g., caches). See also HPA.
TD	Trust Domain	Yes	Trust Domains (TDs) are designed to be hardware isolated Virtual Machines (VMs) deployed using Intel® Trust Domain Extensions (Intel® TDX).
TD OS	Trust Domain Operating System	Yes	The guest operating system that runs in a TD.
TD VM	TD Virtual Machine	Yes	Same as TD
N/A	TD Private Memory (Access)	Yes	TD Private Memory is designed to hold TD private content, encrypted by the CPU using the TD ephemeral key.
N/A	TD Shared Memory (Access)	Yes	TD Shared memory is designed to hold content accessible to the TD and the host software (and/or other TDs). TD shared memory may be encrypted using MKTME keys managed by the VMM.
TDCS	Trust Domain Control Structure	Yes	Multi-page control structure for a TD. TDCS pages are allocated by the host VMM via Intel TDX functions, but their content is intended to be non-architectural and not directly accessible to software.
TDCX	Trust Domain Control Extension	Yes	4KB physical pages that are intended to hold parts of a multi-page control structure.
TDR	Trust Domain Root	Yes	The root control structure for a TD. The TDR page is allocated by the host VMM via Intel TDX functions, but its content is intended to be non-architectural and not directly accessible to software.
TDMR	Trust Domain Memory Range	Yes	A range of memory, configured by the host VMM, that is covered by PAMT and is intended to hold TD private memory and TD control structures.
TDVPS	Trust Domain Virtual Processor State	Yes	A multi-page structure for holding a TD Virtual CPU (VCPU) state. TDVPS pages are allocated by the host VMM via Intel TDX functions, but their content is intended to be non-architectural and not directly accessible to software.
TDVPR	Trust Domain Virtual Processor Root	Yes	A 4KB physical page that is intended to be the root (first) page of a TDVPS.
Intel® TDX	Intel® Trust Domain Extensions	Yes	An architecture, based on the TDX Instruction Set Architecture (ISA) extensions and the Intel TDX module, which supports operation and management of Trust Domains.
TDX ISA	Intel® TDX Instruction Set Architecture	Yes	Intel CPU Instruction Set Architecture (ISA) extensions that support the Intel TDX module: an isolated software module that facilitates the operation and management of Trust Domains.
TEE	Trusted Execution Environment	No	An isolated processing environment in which software can be securely executed irrespective of the rest of the system.

Acronym	Full Name	New for TDX	Description
TME	Intel® Total Memory Encryption	No	A memory encryption/decryption engine using an ephemeral platform key designed to encrypt memory contents exposed externally from the SOC.
XFAM	Extended Features Allowed Mask	Yes	A mask of CPU extended features (in XCR0 format) that the TD is allowed to use.

1.4. Notation

This section describes the notation used in this document.

1.4.1. Requirement and Definition Commitment Levels

When specifying requirements or definitions, the level of commitment is specified following the convention of [RFC 2119: Key words for use in RFCs to indicate Requirement Levels](#), as described in the following table:

Table 1.3: Requirement and Definition Commitment Levels

Keyword	Description
Must	" Must ", " Required " or " Shall " means that the definition is an absolute requirement of the specification.
Must Not	" Must Not " or " Shall Not " means that the definition is an absolute prohibition of the specification.
Should	" Should ", or the adjective " Recommended ", means that there may exist valid reasons in particular circumstances to ignore a particular item, but the full implications must be understood and carefully weighed before choosing a different course.
Should Not	" Should Not ", or the phrase " Not Recommended " means that there may exist valid reasons in particular circumstances when the particular behavior is acceptable or even useful, but the full implications should be understood, and the case must be carefully weighed before implementing any behavior described with this label.
May	" May ", or the adjective " Optional ", means that an item is discretionary. An implementation may choose to include the item, while another may omit the same item, because of various reasons.

1.5. References

1.5.1. Intel Public Documents

Table 1.4: Intel Public Documents

Reference	Document	Version & Date
Intel SDM	Intel® 64 and IA-32 Architectures Software Developer's Manual	325462-076US, December 2021
ISA Extensions	Intel® Architecture Instruction Set Extensions and Future Features Programming Reference	319433-047, December 2022

Reference	Document	Version & Date
Error Reporting through EMCA2	RAS Integration and Validation Guide for the Intel Xeon Processor – Error Reporting through EMCA Gen 2	April 2015

1.5.2. Intel TDX Public Documents

Table 1.5: Intel TDX Public Documents

Reference	Document	Version & Date
TDX Web Page	Intel® Trust Domain Extensions (Intel® TDX) Note: Most documents below are on this web page	
TDX Overview	An introductory overview of the Intel TDX technology	August 2021
TDX Arch Extensions Spec	A specification of Intel CPU architectural support for Intel TDX	May 2021
SEAMLDR Spec	A specification of how a VMM loads the Intel TDX Module on a platform	May 2021
MKTMEi Spec	Intel® Architecture Memory Integrity Specification	Rev. 1.0, March 2020
TDX Module Base Spec	Overview and base architecture specification of the Intel TDX Module version 1.5	September 2021
TD Migration Spec	Overview and architecture specification of the TD Migration feature of the Intel TDX Module version 1.5	September 2021
TDX Module ABI Spec	Application Binary Interface (ABI) specification of the Intel TDX Module version 1.5	September 2021
TDX GHCI Spec	Specification of the software interface between the Guest OS (Tenant and Service TD VMs) and the VMM required for enabling Intel TDX version 1.5	September 2021
MigTD Design Guide	A design guide on how to design and implement a Migration TD for TDX 1.5 Live migration	October 2021

2. Overview of Intel® Trust Domain Extensions

Intel® Trust Domain Extensions (Intel® TDX) refers to an Intel technology that extends Virtual Machines Extensions (VMX) and Multi-Key Total Memory Encryption (MKTME) with a new kind of virtual machine guest called a **Trust Domain (TD)**. A TD runs in a CPU mode that is designed to protect the confidentiality of its memory contents and its CPU state from any other software, including the hosting Virtual Machine Monitor (VMM), unless explicitly shared by the TD itself.

The TDX solution is built using a combination of Intel® Virtual Machine Extensions (VMX) and Multi-Key Total Memory Encryption (MK-TME), as extended by the **Intel® Trust Domain Extensions Instruction Set Architecture (Intel TDX ISA)**. An attested software module called the **Intel TDX module** is designed to implement the TDX architecture.

The platform is managed by a TDX-aware **host VMM**. As shown in Figure 2.1 below, a host VMM can launch and manage both guest TDs and legacy guest VMs. The host VMM maintains all legacy functionality from the legacy VMs' perspective; it is restricted only with regard to the TDs it manages.

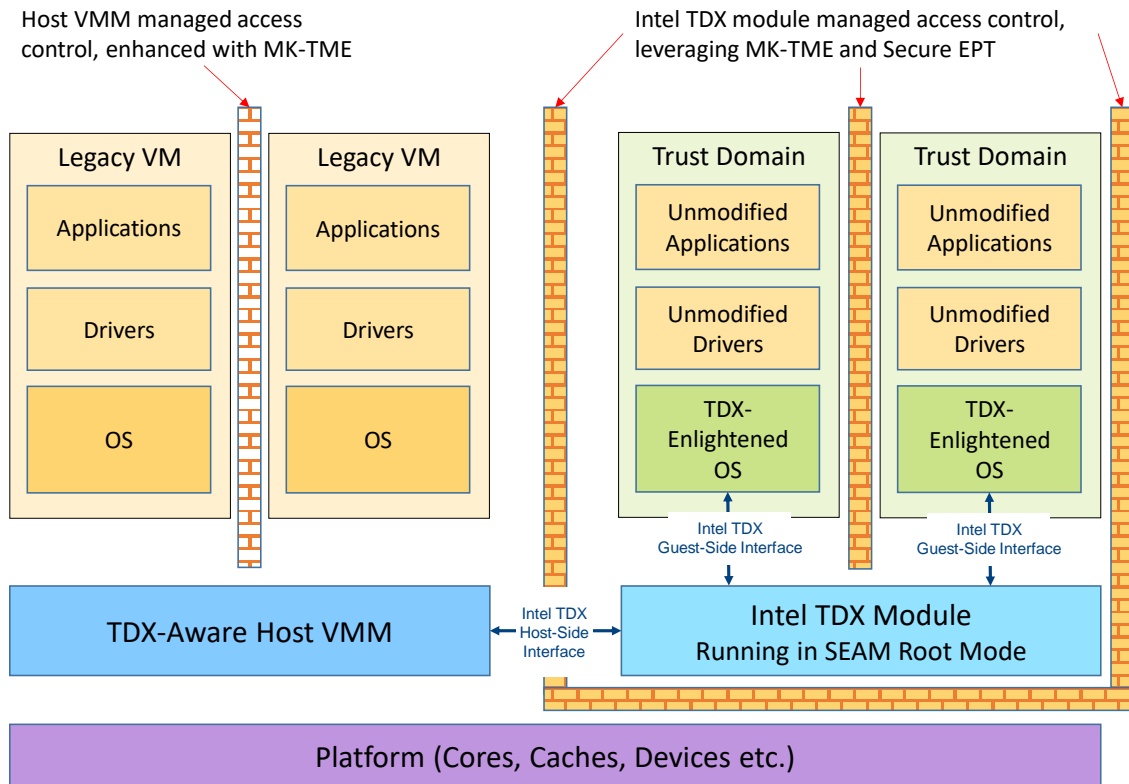

Figure 2.1: Intel® Trust Domain Extension Components Overview

2.1. Intel TDX Module Lifecycle

2.1.1. Boot-Time Configuration and Intel TDX Module Loading

1. BIOS should activate MKTME with TDX private key IDs, configure the SEAMRR registers and prepares a table of **Convertible Memory Regions (CMRs)** – memory regions that can hold TD-private memory pages.
2. BIOS or OS should then install P-SEAMLDR by launching the NP-SEAMLDR ACM.
3. BIOS or OS can retrieve the trusted platform topology and CMR information, as previously checked by MCHECK, using P-SEAMLDR's SEAMINFO API. Based on the above, the host VMM should then decide on a set of Trust Domain Memory Regions (TDMRs). TDMR is a region of convertible memory that may contain some reserved sub-regions.
4. The host VMM can then load the Intel TDX module using P-SEAMLDR's INSTALL API.

2.1.2. **UPDATED:** Intel TDX Module Initialization, Enumeration and Configuration

1. After loading the Intel TDX module, the host VMM should call the TDH.SYS.INIT function to globally initialize the module.
2. The host VMM should then call the TDH.SYS.LP.INIT function on each logical processor. TDH.SYS.LP.INIT is intended to initialize the module within the scope of the Logical Processor (LP).

3. The host VMM should then call the **TDH.SYS.RD/RDALL** or **TDH.SYS.INFO** function to enumerate the Intel TDX module functionality and parameters; it should retrieve the trusted platform topology and CMR information as previously checked by **MCHECK**.
4. The host VMM should then call the **TDH.SYS.RD/RDALL** or **TDH.SYS.INFO** function to enumerate the Intel TDX module functionality and parameters. If not done already, the host VMM can retrieve the trusted platform topology and CMR information, as previously checked by **MCHECK**, and decide on the set of TDMRs.
5. The host VMM should then call the **TDH.SYS.CONFIG** function and pass TDMR information with other configuration information. **TDH.SYS.CONFIG** is intended to check the configuration information vs. the Intel TDX module's trusted internal data.
6. The host VMM should then call the **TDH.SYS.KEY.CONFIG** function per package. **TDH.SYS.KEY.CONFIG** is intended to configure a CPU-generated random key that is used as the Intel TDX module's global private key.
7. The host VMM should then use the **TDH.SYS.TDMR.INIT** function to initialize the TDMRs and their associated control structures.

The Intel TDX module lifecycle is detailed in Chapter 4.

2.2. Guest TD Life Cycle Overview

2.2.1. Guest TD Build

The host VMM can create a new guest TD by allocating and initializing a TD Root (TDR) control structure using the **TDH.MNG.CREATE** function. As an input to **TDH.MNG.CREATE**, the host VMM assigns the TD with a memory protection key identifier, also known as a Host Key ID (HKID). The HKID can be used by the CPU to tag memory accesses done by the TD and by the multi-key total memory encryption engines (MKTMEs) to select the encryption/decryption keys – the keys themselves are designed to not be exposed to the host VMM. The VMM should then program the HKID and encryption key into the MKTME encryption engines using the **TDH.MNG.KEY.CONFIG** function on each package.

Once the TD is assigned a key, the host VMM can build the TD Control Structure (TDCS) by adding control structure pages, using the **TDH.MNG.ADDCX** function, and initialize using the **TDH.MNG.INIT** function. It can then build the Secure EPT tree using the **TDH.MEM.SEPT.ADD** function and add the initial set of TD-private pages using the **TDH.MEM.PAGE.ADD** function. These pages typically contain Virtual BIOS code and data along with some clear pages for stacks and heap. Most of the guest TD code and data is dynamically loaded at a later stage. The guest TD can extend run-time measurement registers, designed to be securely maintained by the Intel TDX module, for the added contents using the **TDH.MR.EXTEND** function.

The host VMM can then create and initialize TD Virtual CPUs (VCPUs). After creating each VCPU using the **TDH.VP.CREATE** function, the VMM allocates a set of pages to hold the VCPU state (in a structure called **TDVPS**) using the **TDH.VP.ADDCX** function. The host VMM can then initialize the VCPU using the **TDH.VP.INIT** function.

After the initial set of pages is added and extended, the VMM can finalize the TD measurement using the **TDH.MR.FINALIZE** function.

2.2.2. Guest TD Execution

The host VMM may enter the TD (launch the TD for the first time or resume a previously intercepted TD execution) using the **TDH.VP.ENTER** function. The Intel TDX module is designed to load CPU state from the **TDVPS** structure and perform VM entry to go into SEAM-root mode.

When TD exit is triggered, the Intel TDX module is designed to save CPU state into the **TDVPS** structure, load the CPU state saved on TD entry, and switch back to non-SEAM root mode (**SEAMRET**) at the instruction following **SEAMCALL**. The VMM can then inspect the TD exit information in General Purpose Registers (GPRs).

2.2.3. Guest TD Management during its Run-Time

During TD lifetime, the VMM might need to dynamically control the TD and manage the resources assigned to it. The Intel TDX module provides the VMM with functions to support scenarios such as:

- Adding and removing TD pages.
- Changing page mapping sizes.
- Reclaiming the HKIDs from a TD and assigning them to another TD.
- Destroying an existing TD.

2.3. Intel TDX Operation Modes and Transitions

The Intel TDX module is designed to provide two main new **logical** modes of operation built upon the new SEAM root and non-root CPU modes added to the Intel VMX architecture: logical TDX Root Mode, and logical TDX Non-Root Mode. Figure 2.2 below shows the Intel TDX logical modes and transitions (in red) on top of the CPU architectural modes.

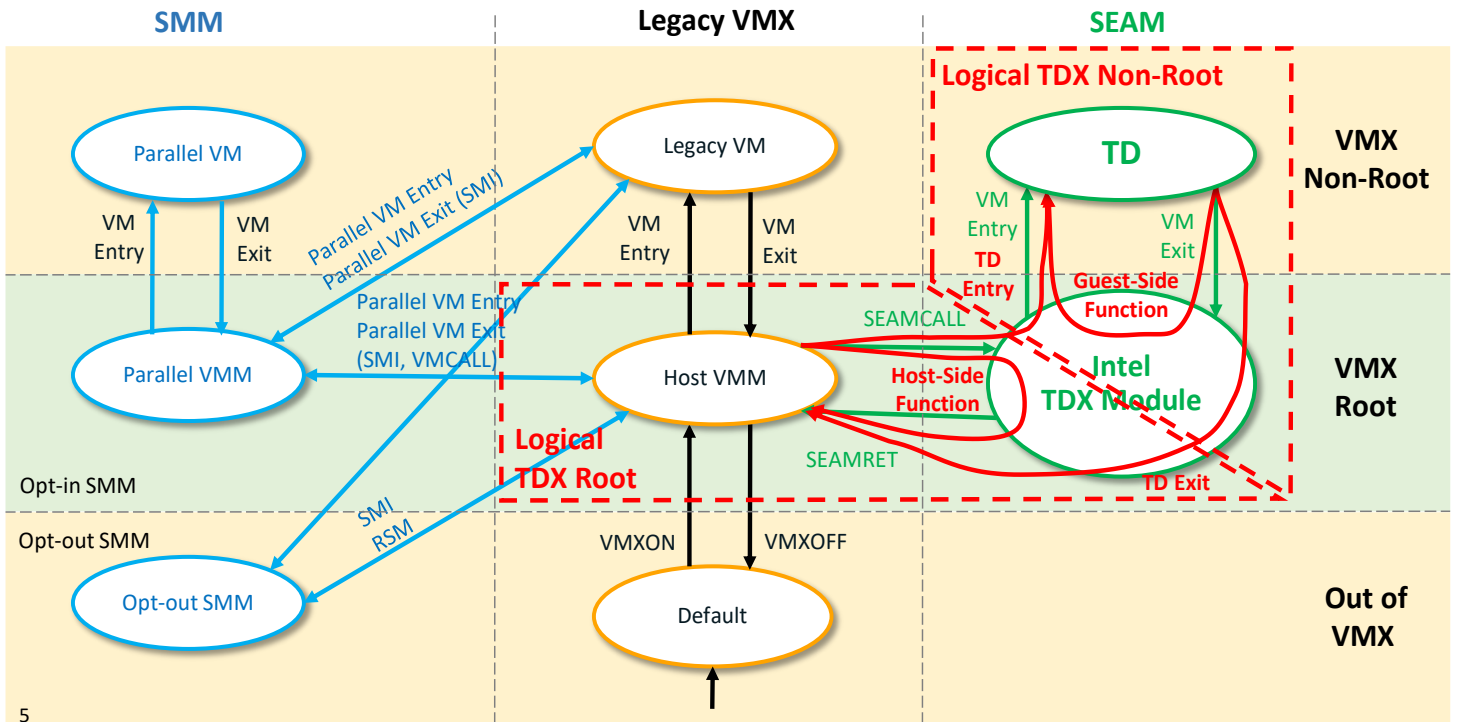

Figure 2.2: Overview of Intel TDX Modes & Transitions based on VMX and SEAM Modes and Transitions

The following table adds more details.

Table 2.1: Overview of Intel TDX Modes

Intel TDX Logical Mode	Intel VMX Mode	SEAM Mode	Description
Logical TDX Root	VMX Root	Non-SEAM (mostly), SEAM Root Mode (during host-side Intel TDX functions execution)	<p>TDX root mode is mostly identical to the legacy VMX root operation mode. It is generally used for host VMM operation.</p> <p>Host-side Intel TDX functions, triggered by SEAMCALL, are provided by the Intel TDX module. Logically, host-side functions run in TDX root mode, though the CPU's SEAM mode is on.</p>
Logical TDX Non-Root	VMX Non-Root (mostly), VMX Root (during guest-side Intel TDX flows execution)	SEAM	<p>TDX non-root mode is used for TD guest operation. TDX non-root operation is similar to legacy VMX non-root operation, with changes and restrictions to better ensure that no other software or hardware has direct visibility of the TD memory and state.</p> <p>The changes in TDX non-root mode vs. legacy VMX non-root operation are implemented by:</p> <ul style="list-style-type: none"> The CPU running in SEAM non-root mode. This modifies the address translation to support Secure EPT and usage of private HKIDs, and it also modifies the VMX operation (entry, exit, etc.). The Intel TDX module, acting as the root VMM for the guest TD, using VMX and SEAM to virtualize the CPU behavior and emulate the required TDX non-root behavior.

Intel TDX Logical Mode	Intel VMX Mode	SEAM Mode	Description
			<p>Guest-side Intel TDX flows, triggered by a VM Exit, are provided by the Intel TDX module. Logically, guest-side functions run in TDX non-root mode, though the CPU runs VMX root mode.</p> <p>TDX non-root operation is described in Chapter 11.</p>

Intel TDX transitions between TDX root operation and TDX non-root operation include **TD Entries**, from logical TDX root to logical TDX non-root mode, and **TD Exits** from logical TDX non-root to logical TDX root mode. A TD Exit might be **asynchronous**, triggered by some external event (e.g., external interrupt or SMI) or an exception, or it might be **synchronous**, triggered by a TDCALL(TDG.VP.VMCALL) function.

2.4. Guest TD Private Memory Protection

2.4.1.1. Memory Encryption

The Intel TDX module helps protect guest TD private memory using memory encryption and integrity protection as enabled by the CPU's MKTME and TDX ISA features. The Intel TDX module adds **key management functionality** to help enforce its security objectives.

Memory encryption is designed to be performed by encryption engines that reside at each memory controller. An encryption engine holds a table of encryption keys, known as the Key Encryption Table (KET). An encryption key is selected for each memory transaction based on a **Host Key Identifier (HKID)** that should be provided with the transaction.

In the first generation of MKTME, HKID is "stolen" from the physical address by allocating a configurable number of bits from the top of the physical address. TDX ISA is designed to further partition the HKID space into **shared HKIDs** for legacy MKTME accesses and **private HKIDs** for SEAM-mode-only accesses. Future generations might choose to express HKID differently.

During SEAM non-root operation, memory accesses can be qualified as either shared or private, based on the value of a new SHARED bit in the Guest Physical Address (GPA). Shared accesses are intended to behave as legacy memory accesses and use the upper bits of the host physical address as an HKID, which must be from the range allocated to legacy MKTME. Private accesses use the guest TD's private HKID.

The host-side Intel TDX functions help provide the means for the host VMM to manage HKID assignment to guest TDs, configure the memory encryption engines, etc., while better assuring proper operation to help maintain the TDX's security objectives. By design, the host VMM does not have access to the encryption keys.

Encryption-based memory protection is described in the [MKTME PAS] and [SEAM PAS]. Key management is described in Chapter 4.

2.4.2. Address Translation

Guest Physical Address (GPA) space is divided into private and shared sub-spaces, determined by the SHARED bit of GPA.

As designed, the CPU translates shared GPAs using the Shared EPT, which resides in host VMM memory. The Shared EPT is directly managed by the host VMM – the same as with legacy VMX.

As designed, the CPU translates private GPAs using a separate Secure EPT. The Secure EPT pages are encrypted and integrity-protected with the TD's ephemeral private key. The Secure EPT is not intended to be directly accessible by any software other than the Intel TDX module, nor by any devices. Secure EPT can be managed indirectly by the host VMM, using Intel TDX functions. The Intel TDX module helps ensure that the Secure EPT security properties are kept. At the end of translation, the CPU sets the HKID bits in the HPA to the TD's assigned HKID.

TD private memory management is described in Chapter 9.

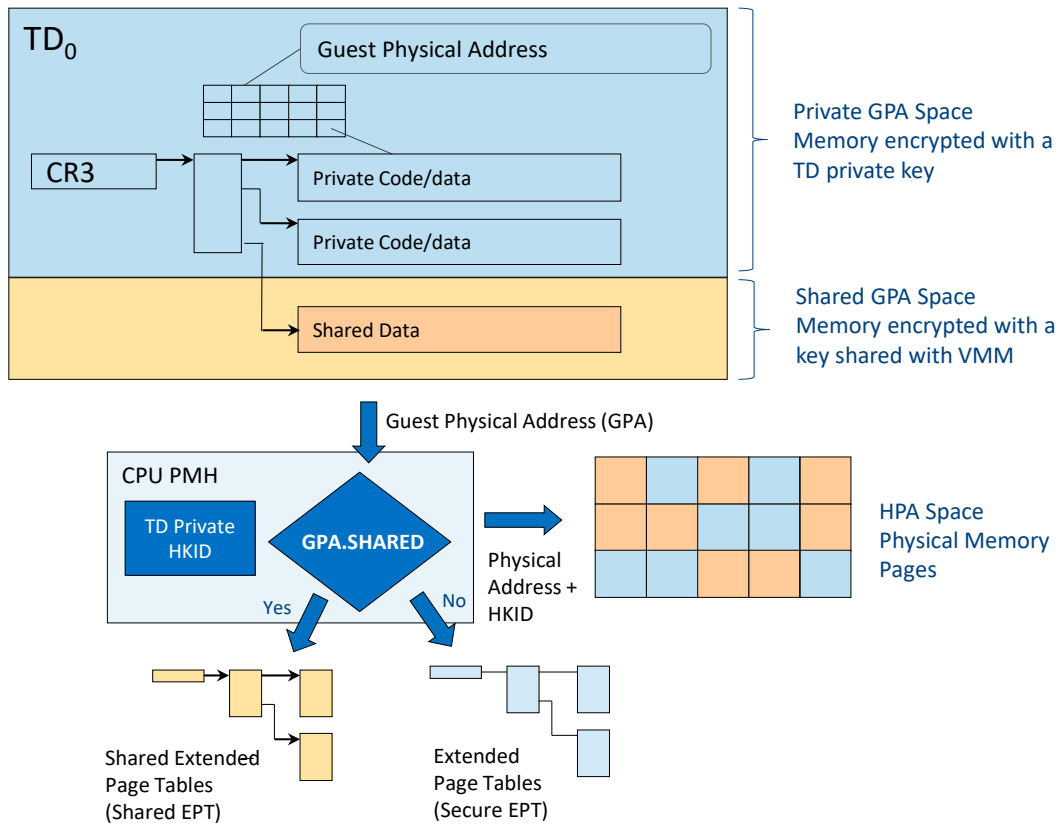

Figure 2.3: Secure EPT Concept

2.5. Guest TD State Protection

Intel TDX helps protect the confidentiality and integrity of a guest TD and the state of its Virtual CPUs (VCPUs) with the following mechanisms:

Protected Control Structures TD-scope and TD VCPU-scope control structures, which hold guest TD metadata and TD VCPU state, are not directly accessible to any software (besides the Intel TDX module) or devices. As designed, the control structures are encrypted and integrity-protected with a private key and managed by Intel TDX functions. TD control structures are described in Chapter 6.

VCPU State on TD Transitions On asynchronous TD exits, which usually happen due to external events, the CPU state is saved to the VCPU control structures, and a synthetic state is loaded into the CPU registers. On the following TD Entry, the CPU state is restored from the protected control structures.

On synchronous TD-initiated exit, using the TDCALL(TDG.VP.VMCALL) function, selected GPR and XMM state can be passed as-is to the host VMM. On the following TD entry, that state can be passed back as-is to the guest TD.

2.6. Intel TDX I/O Model

The TD guest can use the following I/O models:

- Paravirtualized devices
- Paravirtualized devices with MMIO emulation
- Direct assignment of devices to a TD

The Intel TDX architecture does not provide specific mechanisms for trusted I/O. Any integrity or confidentiality protection of data submitted to or received from physical or emulated devices must be done by the guest software using cryptography.

Intel TDX I/O is detailed in Chapter 13.

2.7. Measurement and Attestation

As designed, during TD launch, the initial contents and configuration of the TD are recorded by the Intel TDX module. In addition, run-time measurement registers can be used by the guest TD software, e.g., to measure a boot process. At run-time, the Intel TDX architecture reuses the Intel® Software Guard Extensions (Intel® SGX) attestation infrastructure to provide support for attesting to these measurements as described below.

Intel TDX attestation is intended to be used in two phases:

1. Software within the guest TD can use the TDCALL(TDG.MR.REPORT) function to request the Intel TDX module to generate an integrity protected TDREPORT structure. The Intel TDX ISA provides support for enabling the Intel TDX module to create this structure that includes the TD’s measurements, the Intel TDX module’s measurements, and a value provided by the guest TD software. This will typically be an asymmetric key that the attestation verifier can use to establish a secure channel or protect sensitive data to be sent to the TD software.
2. An Intel SGX Quoting Enclave, written specifically to support quoting Intel TDX TDs, uses a new ENCLU instruction leaf, EVERIFYREPORT2, to help check the integrity of the TDG.MR.REPORT. If it passes, the Quoting Enclave can use a certified quote signing key to sign a quote containing the guest TD’s measurements and the additional data being quoted.

The Quoting Enclave can run anywhere on the platform where Intel SGX is supported.

Note: Running Intel SGX enclaves within a guest TD is not supported.

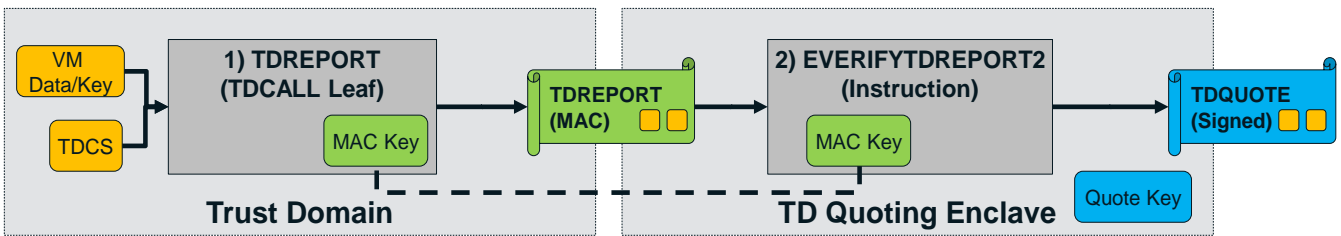

Figure 2.4: TD Attestation

TD measurement and attestation is described in Chapter 12.

2.8. Intel TDX Managed Control Structures

As designed, the Intel TDX module holds and manages a set of control structures that are not directly accessible to software (except the Intel TDX module itself). The controls structures are encrypted with private keys and HKIDs, and their content is only accessible in SEAM mode. Most control structures are addressable by the host VMM, which is responsible for allocating the memory to hold them.

The Intel TDX module uses control structures to help manage TD-private memory, transitions into and out of logical TDX non-root operation (TD entries and TD exits), as well as processor behavior in SEAM non-root operation.

Table 2.2: TDX-Managed Control Structures Overview

Scope	Name	Meaning	Description
Platform	KOT	Key Ownership Table	Designed to control private HKID assignment. KOT is internal to the Intel TDX module, intended not to be directly accessible to any other software.
	PAMT	Physical Address Metadata Table	PAMT is designed to hold metadata of each page in a Trust Domain Memory Range (TDMR). It controls assignment of physical pages to guest TDs, etc. The PAMT is intended not to be directly accessible to software. It resides in memory allocated by the host VMM on TDX initialization.

Scope	Name	Meaning	Description
Guest TD	TDR	Trust Domain Root	TDR is intended to be the root control structure of a guest TD. It controls the key management and build/teardown process. The TDR is not intended to be directly accessible to software. It resides in memory allocated by the host VMM, via Intel TDX interface functions.
	TDCS	Trust Domain Control Structure	TDCS is intended to control the operation of a guest TD as a whole. The TDCS is not intended to be directly accessible to software. It resides in memory allocated by the host VMM, via Intel TDX interface functions.
	SEPT	Secure EPT	Secure EPT is an Extended Page Table (EPT) tree, managed by the TDX module, and used to help securely manage address translation for the TD private pages. The SEPT is not intended to be directly accessible to software. SEPT pages reside in memory allocated by the host VMM via Intel TDX interface functions.
Guest TD VCPU	TDVPS	Trust Domain Virtual Processor State	The TDVPS helps control the operation and hold the state of a guest TD virtual processor. It holds the TD VMCS and its auxiliary structures as well as other non-VMX control and state fields. The TDVPS is not intended to be directly accessible to software. It resides in memory allocated by the host VMM, via Intel TDX interface functions.

Intel TDX control structures are described in Chapter 6.

2.9. Intel TDX Interface Functions

The Intel TDX module implements functions that are triggered by executing two TDX instructions:

- 5 **SEAMCALL** The instruction used by the host VMM to invoke **host-side TDX interface functions**. The desired interface function is selected by an input operand (**leaf number**, in RAX). Host-side interface function names start with TDH (Trust Domain Host).
- 10 **TDCALL** The instruction used by the guest TD software (in SEAM non-root mode) to invoke **guest-side TDX functions**. The desired interface function is selected by an input operand (**leaf number**, in RAX). Guest-side interface function names start with TDG (Trust Domain Guest).

Intel TDX interface function details are described in the [TDX Module ABI Spec].

2.9.1. Host-Side (SEAMCALL Leaf) Interface Functions

Table 2.3: Host-Side (SEAMCALL Leaf) Interface Functions

Class	Interface Function Name	Leaf #	Description
Intel TDX Module Management	TDH.SYS.CONFIG	45	Globally configure the Intel TDX module
Intel TDX Module Management	TDH.SYS.INFO	32	Get Intel TDX module information
Intel TDX Module Management	TDH.SYS.INIT	33	Globally initialize the Intel TDX module
Intel TDX Module Management	TDH.SYS.KEY.CONFIG	31	Configure the Intel TDX global private key on the current package
Intel TDX Module Management	TDH.SYS.LP.INIT	35	Initialize the Intel TDX module per logical processor
Intel TDX Module Management	TDH.SYS.LP.SHUTDOWN	44	Does nothing; provided for backward compatibility
Intel TDX Module Management	TDH.SYS.RD	34	Read a TDX Module global-scope metadata field
Intel TDX Module Management	TDH.SYS.RDALL	37	Read all host-readable TDX Module global-scope metadata fields

Class	Interface Function Name	Leaf #	Description
Intel TDX Module Management	TDH.SYS.SHUTDOWN	52	Shutdown the Intel TDX module and prepare handoff data
Intel TDX Module Management	TDH.SYS.TDMR.INIT	36	Partially initialize a Trust Domain Memory Region (TDMR)
Intel TDX Module Management	TDH.SYS.UPDATE	53	Populate Intel TDX module state from handoff data
TD Management	TDH.MNG.ADDCX	1	Add a control structure page to a TD
TD Management	TDH.MNG.CREATE	9	Create a guest TD and its TDR root page
TD Management	TDH.MNG.INIT	21	Initialize per-TD control structures
TD Management	TDH.MNG.KEY.CONFIG	8	Configure the TD private key on a single package
TD Management	TDH.MNG.KEY.FREEID	20	Mark the guest TD's HKID as free
TD Management	TDH.MNG.KEY.RECLAIMID	27	Does nothing; provided for backward compatibility
TD Management	TDH.MNG.RD	11	Read TD metadata
TD Management	TDH.MNG.VPFLUSHDONE	19	Check all of a guest TD's VCPUs have been flushed by TDH.VP.FLUSH
TD Management	TDH.MNG.WR	13	Write TD metadata
VCPU Scope	TDH.VP.ADDCX	4	Add a control structure page to a TD VCPU
VCPU Scope	TDH.VP.CREATE	10	Create a guest TD VCPU and its TDVPR root page
VCPU Scope	TDH.VP.ENTER	0	Enter TDX non-root operation
VCPU Scope	TDH.VP.FLUSH	18	Flush the address translation caches and cached TD VMCS associated with a TD VCPU
VCPU Scope	TDH.VP.INIT	22	Initialize the per-VCPU control structures
VCPU Scope	TDH.VP.RD	26	Read VCPU metadata
VCPU Scope	TDH.VP.WR	43	Write VCPU metadata
Physical Memory Management	TDH.PHYMEM.CACHE.WB	40	Write back the contents of the cache on a package
Physical Memory Management	TDH.PHYMEM.PAGE.RDMD	24	Read the metadata of a page in a TDMR
Physical Memory Management	TDH.PHYMEM.PAGE.RECLAIM	28	Reclaim a physical memory page owned by a TD (i.e., TD private page, Secure EPT page or a control structure page)
Physical Memory Management	TDH.PHYMEM.PAGE.WBINVD	41	Write back and invalidate all cache lines associated with the specified memory page and HKID
Private Memory Management	TDH.MEM.PAGE.ADD	2	Add a 4KB private page to a TD during TD build time
Private Memory Management	TDH.MEM.PAGE.AUG	6	Dynamically add a 4KB private page to an initialized TD
Private Memory Management	TDH.MEM.PAGE.DEMOTE	15	Split a 2MB or a 1GB private TD page mapping into 512 4KB or 2MB page mappings respectively
Private Memory Management	TDH.MEM.PAGE.PROMOTE	23	Merge 512 consecutive 4KB or 2MB private TD page mappings into one 2MB or 1GB page mapping respectively
Private Memory Management	TDH.MEM.PAGE.RELOCATE	5	Relocate a 4KB mapped page from its HPA to another
Private Memory Management	TDH.MEM.PAGE.REMOVE	29	Remove a private page from a guest TD
Private Memory Management	TDH.MEM.RANGE.BLOCK	7	Block a TD private GPA range
Private Memory Management	TDH.MEM.RANGE.UNBLOCK	39	Remove the blocking of a TD private GPA range
Private Memory Management	TDH.MEM.RD	12	Read from private memory of a debuggable guest TD
Private Memory Management	TDH.MEM.SEPT.ADD	3	Add and map a 4KB Secure EPT page to a TD
Private Memory Management	TDH.MEM.SEPT.RD	25	Read a Secure EPT entry
Private Memory Management	TDH.MEM.SEPT.REMOVE	30	Remove a Secure EPT page from a TD
Private Memory Management	TDH.MEM.TRACK	38	Increment the TD's TLB tracking counter
Private Memory Management	TDH.MEM.WR	14	Write to private memory of a debuggable guest TD
Measurement and Attestation	TDH.MR.EXTEND	16	Extend the guest TD measurement register during TD build
Measurement and Attestation	TDH.MR.FINALIZE	17	Finalize the guest TD measurement register
Service TD	TDH.SERVTD.BIND	48	Bind a service TD to a target TD
Service TD	TDH.SERVTD.PREBIND	49	Pre-bind a service TD to a target TD
Migration	TDH.MIG.STREAM.CREATE	96	Create a migration stream
Migration Export	TDH.EXPORT.ABORT	64	Abort an export session

Class	Interface Function Name	Leaf #	Description
Migration Export	TDH.EXPORT.BLOCKW	65	Block a TD private page for writing
Migration Export	TDH.EXPORT.MEM	68	Export a list of TD private pages contents and/or cancellation requests
Migration Export	TDH.EXPORT.PAUSE	70	Pause the exported TD
Migration Export	TDH.EXPORT.RESTORE	66	Restore a list of TD private 4KB pages' Secure EPT entry states after an export abort
Migration Export	TDH.EXPORT.STATE.IMMUTABLE	72	Start an export session and export the TD's immutable state
Migration Export	TDH.EXPORT.STATE.TD	73	Export the TD's mutable state
Migration Export	TDH.EXPORT.STATE.VP	74	Export a VCPU mutable state
Migration Export	TDH.EXPORT.TRACK	71	End the current in-order export phase epoch and either start a new epoch or start the out-of-order export phase
Migration Export	TDH.EXPORT.UNBLOCKW	75	Unblock a page that has been blocked for writing
Migration Import	TDH.IMPORT.ABORT	80	Abort an import session
Migration Import	TDH.IMPORT.COMMIT	82	Commit the import session and allow the imported TD to run
Migration Import	TDH.IMPORT.END	81	End an import session
Migration Import	TDH.IMPORT.MEM	83	Import a list of TD private pages contents and/or cancellation requests based on a migration bundle in shared memory
Migration Import	TDH.IMPORT.STATE.IMMUTABLE	85	Start an import session and import the TD's immutable state
Migration Import	TDH.IMPORT.STATE.TD	86	Import the TD's mutable state
Migration Import	TDH.IMPORT.STATE.VP	87	Import a VCPU mutable state
Migration Import	TDH.IMPORT.TRACK	84	End the current in-order import phase epoch and either start a new epoch or start the out-of-order import phase

2.9.2. Guest-Side (TDCALL Leaf) Interface Functions

Table 2.4: Guest-Side (TDCALL Leaf) Interface Functions

Class	Interface Function Name	Leaf #	Description
Intel TDX Module Management	TDG.SYS.RD	11	Read a TDX Module global-scope metadata field
Intel TDX Module Management	TDG.SYS.RDALL	12	Read all guest-readable TDX Module global-scope metadata fields
TD Management	TDG.VM.RD	7	Read a TD-scope metadata field
TD Management	TDG.VM.WR	8	Write a TD-scope metadata field
VCPU Scope	TDG.VP.CPUIDVE.SET	5	Control delivery of #VE on CPUID instruction execution
VCPU Scope	TDG.VP.ENTER	25	Enter L2 VCPU operation
VCPU Scope	TDG.VP.INFO	1	Get TD execution environment information
VCPU Scope	TDG.VP.INVEPT	26	Invalidate cached EPT translations for selected L2 VMs
VCPU Scope	TDG.VP.INVVPID	27	Invalidate cached translations for selected pages in an L2 VM
VCPU Scope	TDG.VP.RD	9	Read a VCPU-scope metadata field
VCPU Scope	TDG.VP.VEINFO.GET	3	Get Virtualization Exception Information for the recent #VE exception
VCPU Scope	TDG.VP.VMCALL	0	Call a host VM service
VCPU Scope	TDG.VP.WR	10	Write a VCPU-scope metadata field
Private Memory Management	TDG.MEM.PAGE.ACCEPT	6	Accept a pending private page into the TD
Private Memory Management	TDG.MEM.PAGE.ATTR.RD	23	Read the GPA mapping and attributes of a TD private page
Private Memory Management	TDG.MEM.PAGE.ATTR.WR	24	Write the attributes of a private page

Class	Interface Function Name	Leaf #	Description
Measurement and Attestation	TDG.MR.REPORT	4	Creates a cryptographic report of the TD
Measurement and Attestation	TDG.MR.RTMR.EXTEND	2	Extend a TD run-time measurement register
Measurement and Attestation	TDG.MR.VERIFYREPORT	22	Verify a cryptographic report of a TD, generated on the current platform
Service TD	TDG.SERVTD.RD	18	Read a target TD metadata field
Service TD	TDG.SERVTD.WR	20	Write a target TD metadata field

DRAFT

3. Software Use Cases

This chapter summarizes the software use cases (also known as software flows) used with the Intel TDX module.

3.1. Intel TDX Module Lifecycle

3.1.1. **UPDATED:** Intel TDX Module Platform-Scope First-Time Initialization

- 5 This sequence is intended to be used by the host VMM to initialize the Intel TDX module at the platform scope.

Table 3.1: Typical Intel TDX Module Platform-Scope First-Time Initialization Sequence

Phase		Intel TDX Function	Scope	Execute On	Description
Boot	1	N/A	Platform	Each core	BIOS configures Convertible Memory Regions (CMRs) and activates MKTME; MCHECK checks them and securely stores the information.
P-SEAMLDR Loading	2	N/A	Platform	One of the BSPs	BIOS or OS launches the NP-SEAMLDR ACM, which loads the Intel P-SEAMLDR module.
Intel TDX Module Loading	3	SEAMLDR.INSTALL	Platform	Each LP, serially	VMM calls the Intel P-SEAMLDR module with “load” scenario to install the first TDX module. The TDX module is installed when SEAMLDR.INSTALL is called on the last LP.
Intel TDX Module Initialization	4	TDH.SYS.INIT	Platform	Any one LP	Perform global initialization of the Intel TDX module.
	5	TDH.SYS.LP.INIT	LP	Each LP	Perform LP-scope, core-scope and package-scope initialization, checking and configuration of the platform and the Intel TDX module.
Enumeration and Configuration	6	TDH.SYS.RD* or TDH.SYS.INFO	Platform	Any initialized LP	Retrieve Intel TDX module information and convertible memory (CMR) information.
	7	TDH.SYS.CONFIG	Platform	Any one LP	Configure the Intel TDX module with TDMR and PAMT setup.
	8	N/A	Package	Each Package	If any MODIFIED cache lines may exist for the PAMT ranges, flush them to memory using, e.g., WBINVD.
	9	TDH.SYS.KEY.CONFIG	Package	Each Package	Configure the Intel TDX global private key used for encrypting PAMT and TDR on the hardware (other TD-scope control structures are encrypted with their respective TD’s ephemeral private keys).
At this point any Intel TDX function may be executed on any LP.					
Memory Initialization	10	TDH.SYS.TDMR.INIT (multiple)	Platform	One or more LPs	Called multiple times to gradually initialize the PAMT structure for each TDMR.
	Once each 1GB block of TDMR has been initialized by TDH.SYS.TDMR.INIT, it can be used to hold TD-private pages.				

3.1.2. **UPDATED:** Intel TDX Module Shutdown and Update

- 10 This sequence is intended to be used by the host VMM to gracefully shut down the Intel TDX module and install a new Intel TDX module. There are 2 scenarios:

- Reload scenario – guest TDs’ context and memory are lost.
- Update scenario - guest TDs’ context and memory are preserved.

3.1.2.1. Intel TDX Module Reload

In the reload scenario, the previous TDX module in SEAM range is erased when the next TDX module is installed. Since in this scenario the previous module can't pass any information to the next TDX module, the next TDX module starts afresh, and all guest TDs' context and memory out of SEAM range becomes effectively inaccessible.

5 **Table 3.2: TDX Module Reload Sequence**

Phase		Intel TDX Function	Scope	Execute On	Description
P-SEAMLDR	1	SEAMLDR.INSTALL with "load" scenario	Platform	All LPs	Installs the next TDX module, regardless of the previous TDX module.
Next TDX module	The initialization sequence continues in the same way as described in 3.1.1 above, steps 3 to 8.				

3.1.2.2. Intel TDX Module Update

10 In the update scenario, the previous TDX module in SEAM range is not fully erased; the previous TDX module can be asked to leave "handoff data" in a specific location of the SEAM range, so that the next TDX module would be able to initialize itself from this handoff data. The next TDX module can thus keep supporting guest TDs' context and memory.

Table 3.3: TDX Module TD-Preserving Update Sequence

Phase		Intel TDX Function	Scope	Execute On	Description
Previous TDX Module	1	TDH.SYS.SHUTDOWN	Platform	Selected LP	Prepare handoff data and mark the TDX module's global state as "shutdown".
P-SEAMLDR	2	SEAMLDR.INSTALL with "update" scenario	Platform	All LPs, serially	Install the next TDX module without clearing the handoff data.
Next TDX Module	3	TDH.SYS.INIT	Platform	Selected LP	Perform global initialization of the Intel TDX module.
	4	TDH.SYS.LP.INIT	LP	All LPs	Perform LP-scope, core-scope and package-scope initializations, checking and configuration of the platform and the Intel TDX module.
	5	TDH.SYS.UPDATE	Platform	Selected LP	Populate internal variables from handoff data. Mark the TDX module's global state as "ready".
At this point any Intel TDX function may be executed on any LP (don't call TDH.SYS.CONFIG, TDH.SYS.KEY.CONFIG and TDH.SYS.TDMR.INIT). In particular, TDs created by previous TDX modules can be re-entered.					

3.2. TD Build

The following sequence is intended to be used by the host VMM to build a TD.

15 **Table 3.4: Typical TD Build Sequence**

	Step	Description	SEAMCALL Leaf Functions	
A	TD Creation and Key Resource Assignment	1	The host VMM finds/allocates a free HKID for the new TD.	TDH.MNG.CREATE TDH.MNG.KEY.CONFIG
	2	The host VMM allocates a 4KB page for the TDR in TDMR. If any MODIFIED cache lines may exist for this page, the host VMM flushes them to memory using, e.g., CLFLUSHOPT or TDH.PHYMEM.PAGE.WBINVD.		

	Step	Description	SEAMCALL Leaf Functions
		<p>3 The host VMM creates the new TD by calling the TDH.MNG.CREATE function (passing HPA of the TDR page). This initializes the target TDR page.</p> <p>4 The TD host VMM configures the MKTME hardware with the TD's private key by calling the TDH.MNG.KEY.CONFIG function on each package.</p> <p>5 At this point, the TD private memory is accessible. The VMM can use Intel TDX interface functions to create control structures and TD private pages as described below.</p>	
B	TDCS Memory Allocation and TD Initialization	<p>1 The host VMM allocates multiple 4KB TDCX pages for TDCS. The number of required TDCX pages is enumerated by TDH.SYS.RD* or TDH.SYS.INFO. If any MODIFIED cache lines may exist for these pages, the host VMM flushes them to memory using, e.g., CLFLUSHOPT or TDH.PHYMEM.PAGE.WBINVD.</p> <p>2 For each TDCX page, the host VMM calls the TDH.MNG.ADDCX function (passing HPA of TDCX) to add the page to the TD.</p> <p>3 The host VMM builds a TD_PARAMS structure. For example, the TD configuration parameters can be obtained from a TD manifest supplied by the TD owner.</p> <p>4 The host VMM calls the TDH.MNG.INIT function (passing the TD_PARAMS structure) to initialize the TD.</p>	TDH.MNG.ADDCX TDH.MNG.INIT
C	Virtual Processor Creation and Configuration (Executed per each VCPU)	<p>1 The host VMM allocates target pages for the VCPU's TDVPR and TDCX pages in TDMR in the context of a TD. The number of required TDCX pages is enumerated by TDH.SYS.RD* or TDH.SYS.INFO. If any MODIFIED cache lines may exist for these pages, the host VMM flushes them to memory using, e.g., CLFLUSHOPT or TDH.PHYMEM.PAGE.WBINVD.</p> <p>2 The host VMM creates a new TD virtual CPU by calling the TDH.VP.CREATE function (passing the HPA of the new TDVPR page and its owner TDR page).</p> <p>3 For each TDCX page, the host VMM calls the TDH.VP.ADDCX function (passing the HPA of the new TDCX page and its parent TDVPR page).</p> <p>4 The host VMM initializes the TD VCPU by calling the TDH.VP.INIT function (passing the HPA of its TDVPR page). It also passes a single 64b parameter that is later passed to the VBIOS in the initial value of RCX. This parameter can be used as a pointer to a configuration structure in shared memory.</p> <p>5 The host VMM allocates Shared EPT for each VP.</p> <p>6 The host VMM uses the TDH.VP.WR function to write to the TD VMCS Shared EPTP field.</p> <p>7 The host VMM may modify a few TD VMCS execution control fields using TDH.VP.WR.</p>	TDH.VP.CREATE TDH.VP.ADDCX TDH.VP.INIT TDH.VP.WR
D	TD Boot Memory Setup	<p>1 The host VMM loads the TD boot image to its memory. The boot image contains code and data pages that typically include a virtual BIOS, OS boot loader, configuration, etc.</p>	TDH.MEM.SEPT.ADD TDH.MEM.PAGE.ADD

	Step	Description	SEAMCALL Leaf Functions	
	2	The host VMM builds the TD Secure EPT by allocating physical pages and calling the TDH.MEM.SEPT.ADD function multiple times. If any MODIFIED cache lines may exist for these pages, the host VMM flushes them to memory using, e.g., CLFLUSHOPT or TDH.PHYMEM.PAGE.WBINVD.	TDH.MR.EXTEND	
	3	The host VMM allocates the initial set of physical pages for the TD boot image and maps them into host address space. If any MODIFIED cache lines may exist for these pages, the host VMM flushes them to memory using, e.g., CLFLUSHOPT or TDH.PHYMEM.PAGE.WBINVD.		
	4	For each TD page: <ol style="list-style-type: none"> The host VMM specifies a TDR as a parameter and calls the TDH.MEM.PAGE.ADD function. It copies the contents from the TD image page into the target TD page which is encrypted with the TD ephemeral key. TDH.MEM.PAGE.ADD also extends the TD measurement with the page GPA. The host VMM extends the TD measurement with the contents of the new page by calling the TDH.MR.EXTEND function on each 256-byte chunk of the new TD page. 		
E	TD Measurement Finalization	1	The host VMM calls the TDH.MR.FINALIZE function, which finalizes the TD measurement.	TDH.MR.FINALIZE
		2	At this point, the TD is finalized. <ul style="list-style-type: none"> Its measurement cannot be modified anymore (except the run-time measurement registers). TD VCPUs can be entered using SEAMCALL(TDH.VP.ENTER). 	

3.3. TD Run Time

3.3.1. Private Memory Management

5 3.3.1.1. Dynamic Page Addition (Shared to Private Conversion)

The following sequence is intended to be used by the host VMM to dynamically add a page to a guest TD.

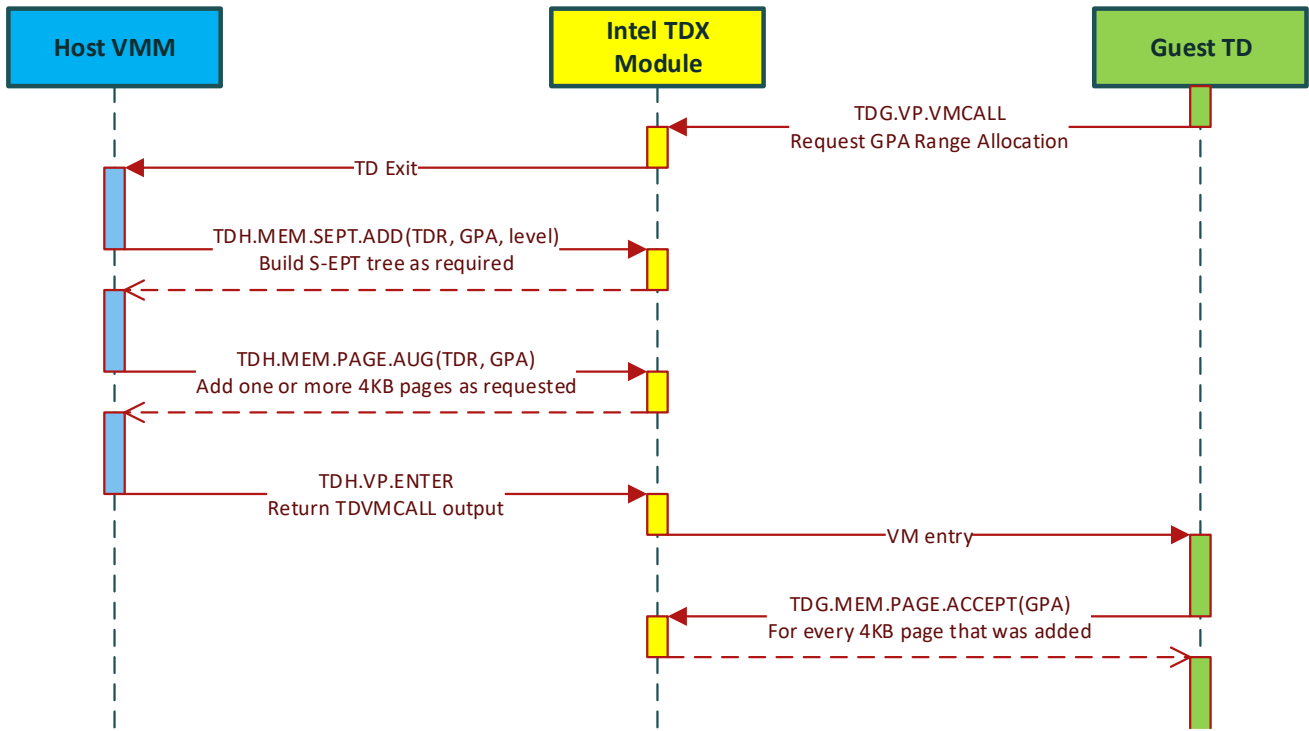

Figure 3.1: Typical Dynamic Page Addition Sequence

Table 3.5: Typical Dynamic Page Addition (Shared to Private Conversion) Sequence

Phase		Side	Intel TDX Function	Scope	Execute On	Description
Allocation Request	1	TD	TDG.VP.VMCALL	TD	Any LP	Optional software protocol: Request GPA range allocation.
Page Addition	2	VMM	TDH.MEM.SEPT.ADD	TD	Any LP	If required, update the Secure EPT.
	3	VMM	TDH.MEM.PAGE.AUG (multiple)	TD	Any LP	Add one or more new 4KB or 2MB private pages.
	At this point, the new page is pending acceptance by the guest TD and cannot be accessed by it yet.					
	4	VMM	TDH.VP.ENTER	TD	Any LP	Optional software protocol: Return TDG.VP.VMCALL result.
Page Acceptance	5	TD	TDG.MEM.PAGE.ACCEPT (multiple)	TD	Any LP	Accept the new pending page(s). Content of each page is zeroed out.
At this point, the new page can be accessed by the guest TD.						

5

3.3.1.2. Dynamic Page Removal (Private to Shared Conversion)

The following sequence is intended to be used by the host VMM to dynamically remove a page from a guest TD. Dynamic page removal is detailed in 0.

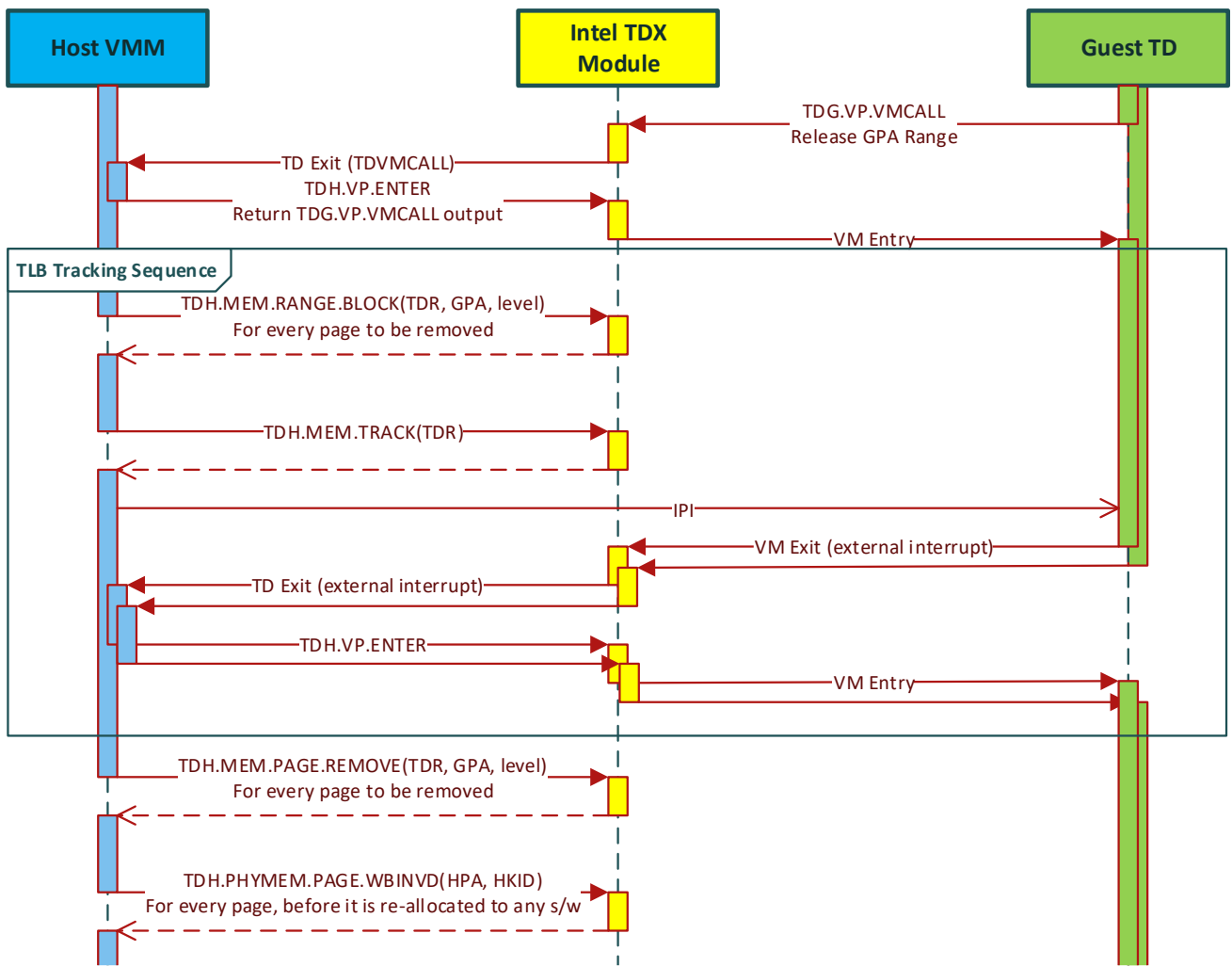

Figure 3.2: Typical Dynamic Page Removal Sequence

Table 3.6: Typical Dynamic Page Removal (Private to Shared Conversion) Sequence

Phase		Side	Intel TDX Function	Scope	Execute On	Description
Ballooning Notification	1	TD	TDG.VP.VMCALL	TD	Any LP	Optional software protocol: Release GPA range.
	2	VMM	TDH.VP.ENTER	TD	Any LP	Optional software protocol: Return TDG.VP.VMCALL result.
TLB Tracking Sequence	3	VMM	TDH.MEM.RANGE.BLOCK (multiple)	TD	Any LP	Block private pages from further address translation.
	4	VMM	TDH.MEM.TRACK	TD	Any one LP	Increment the TD's TLB epoch.
	5	VMM	N/A	TD	Multiple LPs	Send an IPI, causing TD exit on any remote LP associated with a VCPU. Subsequent TDH.VP.ENTER will flush TLB.
Page Removal	6	VMM	TDH.MEM.PAGE.REMOVE (multiple)	TD	Any LP	Clear Secure EPT entry. Mark the physical page as free.

Phase		Side	Intel TDX Function	Scope	Execute On	Description
Cache Flushing & Content Init	Before re-allocating any of the removed pages to any use, the host VMM should ensure none of the cache lines of the removed pages are in the MODIFIED state to avoid corruption due to cache line aliasing. This is done using one of the following methods:					
	7a	VMM	TDH.PHYMEM.PAGE.WBINVD (multiple)	TD	Any one LP	Flush the cache lines of the removed page(s).
	7b	VMM	WBNOINVD	Platform	One LP per package ²	Globally write back all caches.
	7c	VMM	WBINVD	Platform	One LP per package ³	Globally write back and invalidate all caches.
	8	VMM	MOVDIR64B	Page	Any LP	Initialize the physical page content for use with a new shared HKID.

3.3.1.3. Page Promotion (Mapping Merge)

Page size promotion is intended to be used by the host VMM to merge 512 pages mapped as 4KB or 2MB into a single page mapped as 2MB or 1GB, respectively. It is detailed in 9.11.

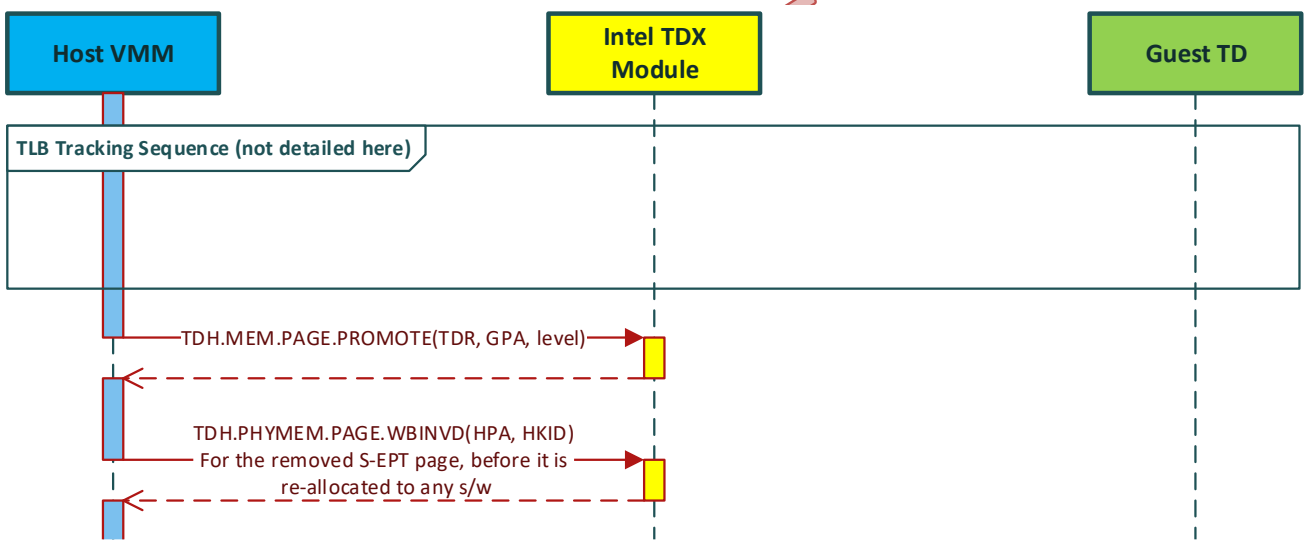

Figure 3.3: Typical Page Promotion Sequence

² Some CPUs may require running WBNOINVD per core.

³ Some CPUs may require running WBINVD per core.

Table 3.7: Typical Page Promotion (Mapping Merge) Sequence

Phase		Intel TDX Function	Scope	Execute On	Description
TLB Tracking Sequence	1	TDH.MEM.RANGE.BLOCK	TD	Any LP	Block the GPA range to be merged from further address translation.
	2	TDH.MEM.TRACK	TD	Any one LP	Increment the TD's TLB epoch.
	3	N/A	TD	Multiple LPs	Send an IPI, causing TD exit on any remote LP associated with a VCPU. Subsequent TDH.VP.ENTER will flush TLB.
Promotion	4	TDH.MEM.PAGE.PROMOTE	TD	Any LP	Merge small pages in the GPA range into a large page.
Cache Flushing & Content Init	5	TDH.PHYMEM.PAGE.WBINVD	TD	Any LP	Flush the removed Secure EPT page's cache lines.
	6	MOVDIR64B	Page	Any LP	Initialize the physical page content for use with a new shared HKID.

3.3.1.4. Page Demotion (Mapping Split)

Page size demotion is intended to be used by the host VMM to split a page mapped as 1GB or 2MB into 512 pages mapped as 2MB or 4KB, respectively. It is detailed in 9.12.

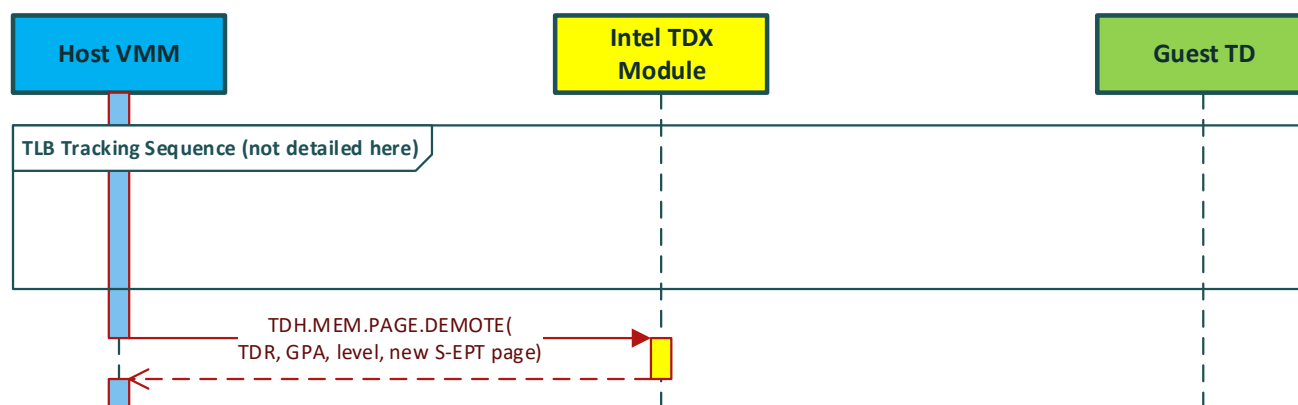

Figure 3.4: Typical Page Demotion Sequence

Table 3.8: Typical Page Demotion (Mapping Split) Sequence

Phase		Intel TDX Function	Scope	Execute On	Description
TLB Tracking Sequence	1	TDH.MEM.RANGE.BLOCK	TD	Any LP	Block private large page from further address translation.
	2	TDH.MEM.TRACK	TD	Any one LP	Increment the TD's TLB epoch.
	3	N/A	TD	Multiple LPs	Send an IPI, causing TD exit on any remote LP associated with a VCPU. Subsequent TDH.VP.ENTER will flush TLB.
Demotion	4	TDH.MEM.PAGE.DEMOTE	TD	Any LP	Split the large page into multiple small pages.

10

3.3.1.5. GPA Range Unblock

GPA range unblock is intended to be used when a range has been blocked, for example, for page removal, but the host VMM decides to cancel the operation. Unblock is detailed in 0.

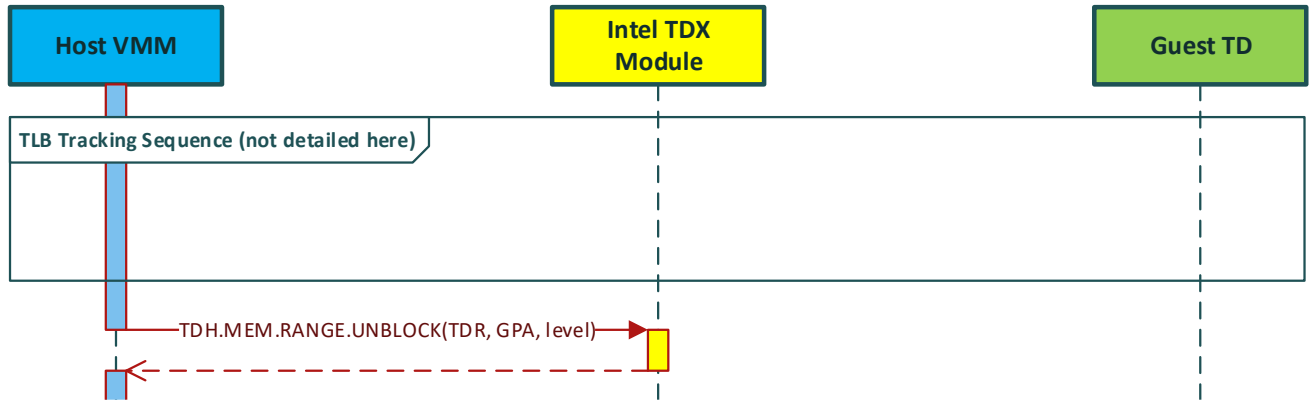

5 Figure 3.5: Typical GPA Range Unblock Sequence

Table 3.9: Typical GPA Range Unblock Sequence

Phase		Intel TDX Function	Scope	Execute On	Description
TLB Tracking Sequence	1	TDH.MEM.RANGE.BLOCK (multiple)	TD	Any LP	Block private GPA range from further address translation.
	2	TDH.MEM.TRACK	TD	Any one LP	Increment the TD’s TLB epoch.
	3	N/A	TD	Multiple LPs	Send an IPI, causing TD exit on any remote LP associated with a VCPU. Subsequent TDH.VP.ENTER will flush TLB.
Unblocking	4	TDH.MEM.RANGE.UNBLOCK	TD	Any LP	Remove the private GPA range blocking.

3.3.2. Guest TD Execution

10 3.3.2.1. TD VCPU First-Time Invocation

Table 3.10: Typical TD VCPU First-Time Invocation Sequence

Phase		Side	Intel TDX Function	Scope	Execute On	Description
Entering TD VCPU (First Time)	1	VMM	N/A	LP	LP x	Save VMM LP state not preserved across TD Entry to TD exit.
	2	VMM	TDH.VP.ENTER	VCPU/LP	LP x	Restore initial LP state, as set by TDH.VP.INIT, from TDVPS and enter SEAM non-root mode.
TD VCPU Initial Execution	TD software (VBIOS) starts execution in 32-bit protected mode with no paging.					
	3	TD	N/A	VCPU/LP	LP x	TD software parses initial information in GPR, builds page tables and switches to 64-bit mode.
TD software (VBIOS) now executes in 64-bit mode.						
Enumeration	4	TD	TDG.VP.INFO	VCPU/LP	LP x	TD software retrieves basic TD and execution environment information.

Phase		Side	Intel TDX Function	Scope	Execute On	Description
	5	TD	TDG.MR.REPORT	VCPU/LP	LP x	TD software retrieves additional TD information.
TD continues execution in SEAM non-root mode.						

3.3.2.2. TD VCPU Entry, Exit on TDG.VP.VMCALL and Re-Entry

Table 3.11: Typical TD Entry, Exit on TDG.VP.VMCALL and Re-Entry Sequence

Phase		Side	Intel TDX Function	Scope	Execute On	Description
TD Entry	1	VMM	N/A	LP	LP x	Save VMM LP state not preserved across TD Entry to TD exit.
	2	VMM	TDH.VP.ENTER	VCPU/LP	LP x	Restore LP state from TDVPS and enter SEAM non-root mode.
	TD executes in TDX non-root mode.					
Software Protocol over TDG.VP.VMCALL	3	TD	TDG.VP.VMCALL	VCPU/LP	LP x	Exit SEAM non-root mode, save LP state to TDVPS, and set synthetic state (except most GPRs and all XMMs).
	4	VMM	N/A	LP	LP x	Optionally: Restore VMM LP state saved before TDH.VP.ENTER.
	5	VMM	N/A	LP	LP x	Perform TDG.VP.VMCALL function, as determined by the TD-VMM software contract (out of the scope for this document).
	6	VMM	N/A	LP	LP x	Save VMM LP state not preserved across TD Entry to TD exit.
	7	VMM	TDH.VP.ENTER	VCPU/LP	LP x	Restore LP state from TDVPS (except most GPRs and all XMMs). Enter SEAM non-root mode.
	8	TD	N/A	VCPU/LP	LP x	Parse TDG.VP.VMCALL output operands as determined by TD – VMM software contract.
TD Execution	TD continues execution in SEAM non-root mode.					

5 3.3.2.3. TD VCPU Entry, Exit on Asynchronous Event and Re-Entry

Table 3.12: Typical TD Entry, Exit on Asynchronous Event and Re-Entry Sequence

Phase		Side	Intel TDX Function	Scope	Execute On	Description
TD Entry	1	VMM	N/A	LP	LP x	Save LP state not preserved across TD Entry to TD exit.
	2	VMM	TDH.VP.ENTER	VCPU/LP	LP x	Restore LP state from TDVPS. Enter SEAM non-root mode.
TD executes in TDX non-root mode.						

Phase		Side	Intel TDX Function	Scope	Execute On	Description
Async. TD Exit and Re-Entry	3	TD	N/A	VCPU/LP	LP x	Asynchronous event (interrupt, exception, EPT violation, etc.) causes TD exit. Save LP state to TDVPS and set synthetic state.
	4	VMM	N/A	LP	LP x	Restore any required LP state saved by the VMM before TDH.VP.ENTER.
	5	VMM	N/A	LP	LP x	Handle the asynchronous event.
	6	VMM	N/A	LP	LP x	Save VMM LP state not preserved across TD Entry to TD exit.
	7	VMM	TDH.VP.ENTER	VCPU/LP	LP x	Restore LP state from TDVPS and enter SEAM non-root mode.
TD Execution	TD continues execution in SEAM non-root mode.					

3.3.2.4. Guest-Side Functions

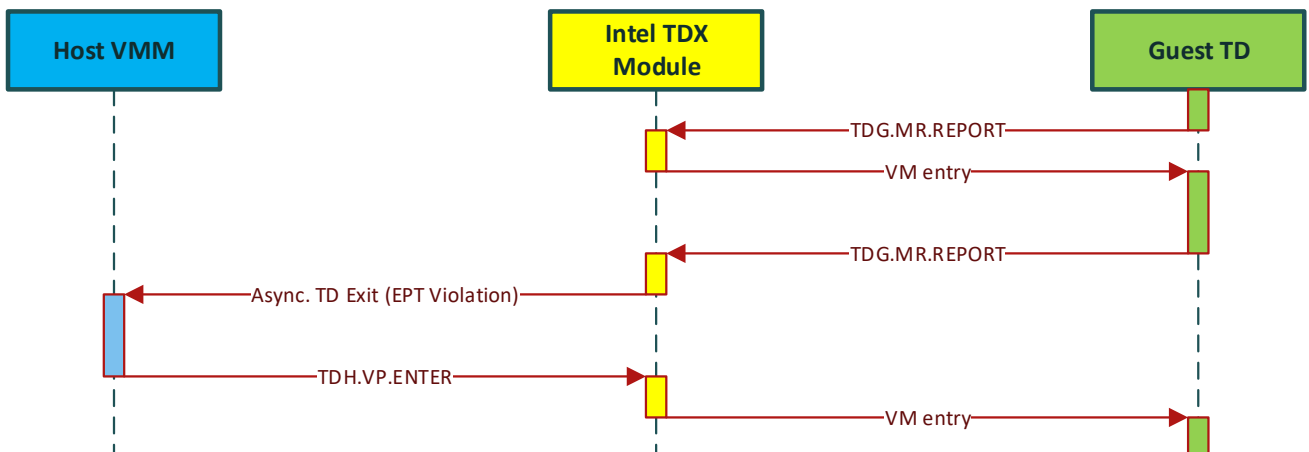

Figure 3.6: Typical Guest-Side Function Sequences

5

Table 3.13: Typical Guest-Side Functions Sequences

Case		Side	Intel TDX Function	Scope	Execute On	Description
Guest-Side Function Returns to Guest TD	TD executes in SEAM non-root mode					
	1	TD	TDG.MR.REPORT	VCPU/LP	LP x	The guest TD VM exits to the Intel TDX module, which handles the guest-side function and re-enters the TD.
TD continues execution in SEAM non-root mode						
Guest-Side Function Causes Async. TD Exit	2	TD	TDG.MR.REPORT	VCPU/LP	LP x	The guest TD exits to the Intel TDX module, which handles the guest-side function, but an asynchronous event (e.g., EPT violation, etc.) causes TD exit.
	3	VMM	N/A	LP	LP x	Optional: The host VMM restores the VMM LP state saved before TDH.VP.ENTER.
	4	VMM	N/A	LP	LP x	The host VMM handles the asynchronous event.

Case		Side	Intel TDX Function	Scope	Execute On	Description
	5	VMM	N/A	LP	LP x	The host VMM saves any VMM LP state not preserved across TD Entry to TD exit.
	6	VMM	TDH.VP.ENTER	VCPU/LP	LP x	The Intel TDX module restores LP state from TDVPS and enters SEAM non-root mode.
TD continues execution in SEAM non-root mode.						

3.3.2.5. TD VCPU Rescheduling (Migration to Another LP)

The Intel TDX module is designed to allow a TD VCPU to be associated with at most one LP at any time. The host VMM must explicitly break this association in order to migrate the VCPU to another LP.

5

Table 3.14: Typical VCPU Migration to Another LP Sequence

Phase		Intel TDX Function	Scope	Execute On	Description
Old VCPU → LP Association	1	Any VCPU-specific SEAMCALL leaf	VCPU	Old LP	Any VCPU-specific SEAMCALL leaf (e.g., TDH.VP.INIT, TDH.VP.ENTER, TDH.VP.RD, etc.) creates an association between the current LP and the VCPU.
Breaking Old VCPU → LP Association	2	TDH.VP.FLUSH	VCPU	Old LP	Break the VCPU-LP association: flush the VCPU's TD VMCS to TDVPS memory and flush the VCPU's TLB ASID.
At this point the VCPU is not associated with any LP.					
New VCPU → LP Association	3	Any VCPU-specific SEAMCALL leaf	VCPU	New LP	Create a new VCPU-LP association.

3.4. TD Destruction

The following sequence is intended to be used by the host VMM to destroy a TD and reclaim all its resources.

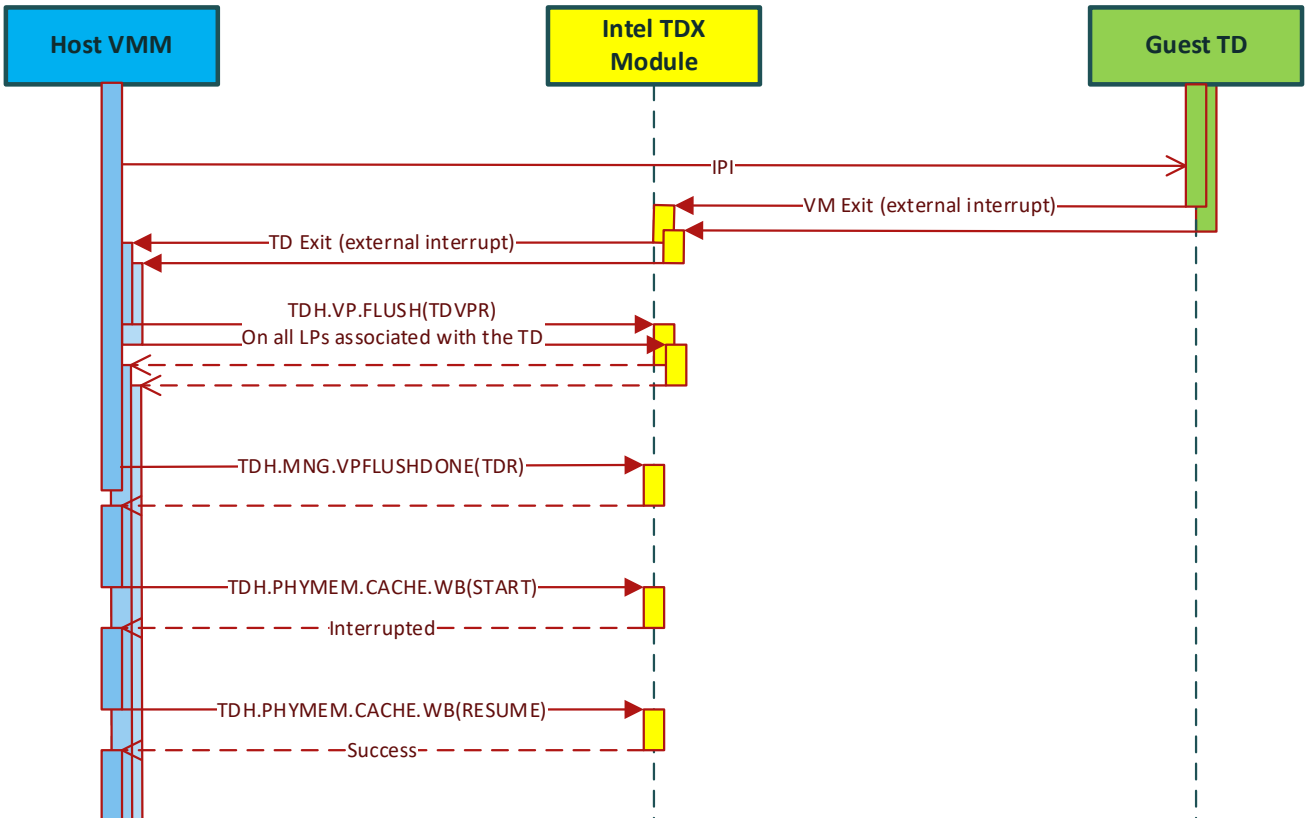

Figure 3.7: Typical TD Destruction Sequence Step A: Stopping and Flushing Out

5

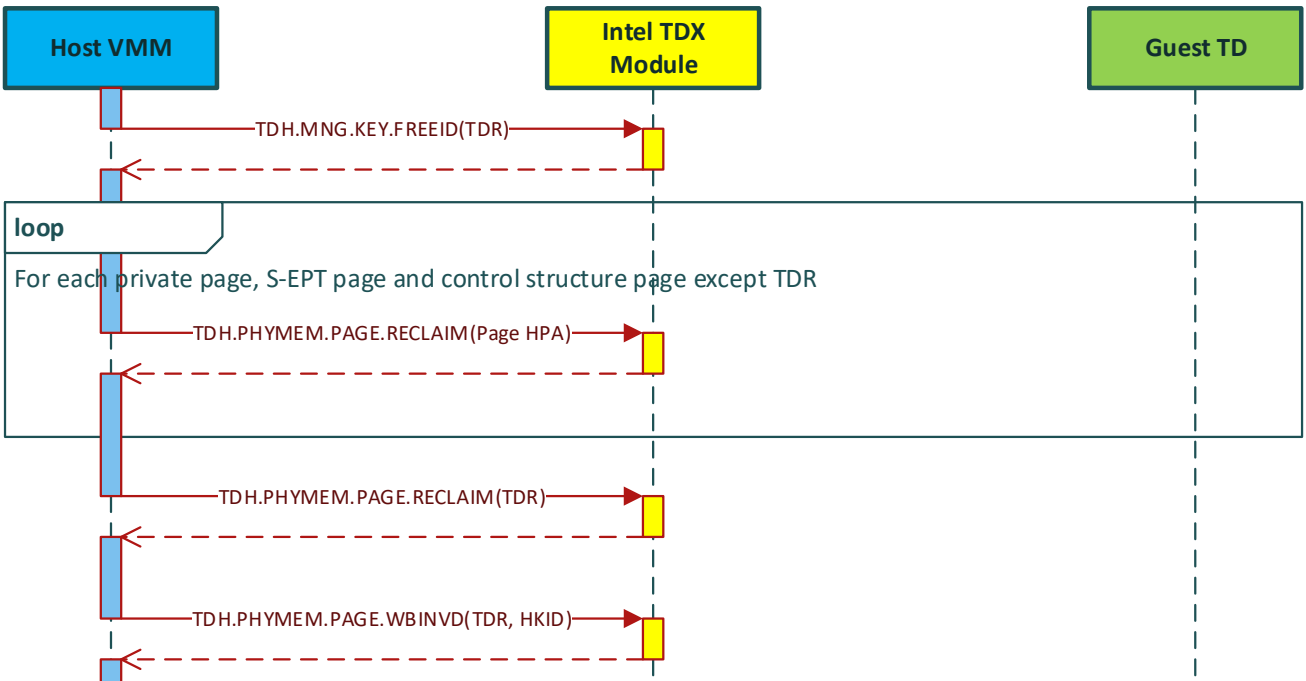

Figure 3.8: Typical TD Destruction Sequence Step B: Resource Reclamation

Table 3.15: Typical TD Destruction Sequence

	Step	Description	SEAMCALL Leaf Functions	
A	TD Stopping and Flushing Out	1	The host VMM selects a TD to destroy. It sends a virtual interrupt to the TD to shut down gracefully.	TDH.VP.FLUSH TDH.MNG.VPFLUSHDONE TDH.PHYMEM.CACHE.WB
		2	The host VMM broadcasts inter-processor interrupts (IPIs) and must ensure TD exit on all logical processors.	
		3	The host VMM calls the TDH.VP.FLUSH function on all LPs associated with a TD VCPU to flush the TLBs and cached TD VMCS associated with a TD VCPU on those LPs.	
		4	The host VMM calls the TDH.MNG.VPFLUSHDONE function. It checks that above step executed for all the TD's VCPUs are associated with an LP.	
		5	The host VMM calls the TDH.PHYMEM.CACHE.WB function on each package to write back to memory the TD contents from all caches. TDH.PHYMEM.CACHE.WB is interruptible by external events. The host VMM should restart it if it indicates it was interrupted, until successfully completed.	
		6	At this point, no address translations or cache lines may exist for this TD except for the TDR page.	
B	Resource Reclamation	1	The host VMM calls the TDH.MNG.KEY.FREEID function. It marks the HKID used by the TD as available for other TDs.	TDH.MNG.KEY.FREEID TDH.PHYMEM.PAGE.RECLAIM TDH.PHYMEM.PAGE.WBINVD
		2	For each physical page in TDMR allocated to the TD (TD private pages, Secure EPT pages, and control structures except TDR), the host VMM calls the TDH.PHYMEM.PAGE.RECLAIM function to mark the page as free and initializes its content using MOVDIR64B.	
		3	The host VMM calls the TDH.PHYMEM.PAGE.RECLAIM function to mark the TDR page as free. The function checks that all other TD physical pages have been reclaimed before.	
		4	Before allocating the reclaimed TDR physical page to any use, the host VMM calls TDH.PHYMEM.PAGE.WBINVD to flush its cache lines and initializes its content using MOVDIR64B.	

SECTION 2: INTEL TDX MODULE ARCHITECTURE SPECIFICATION

DRAFT

4. UPDATED: Intel TDX Module Lifecycle: Enumeration, Initialization and Shutdown

This chapter discusses the design of the Intel TDX module life cycle: how its capabilities are enumerated by the host VMM, how it is initialized, how it is configured and how it is shut down.

4.1. UPDATED: Overview

TDX module lifecycle use cases are described in 3.1.

4.1.1. UPDATED: Intel TDX Module Lifecycle State Machine

The Intel TDX lifecycle state machine helps track the module’s life cycle through the initialization sequence and shutdown.

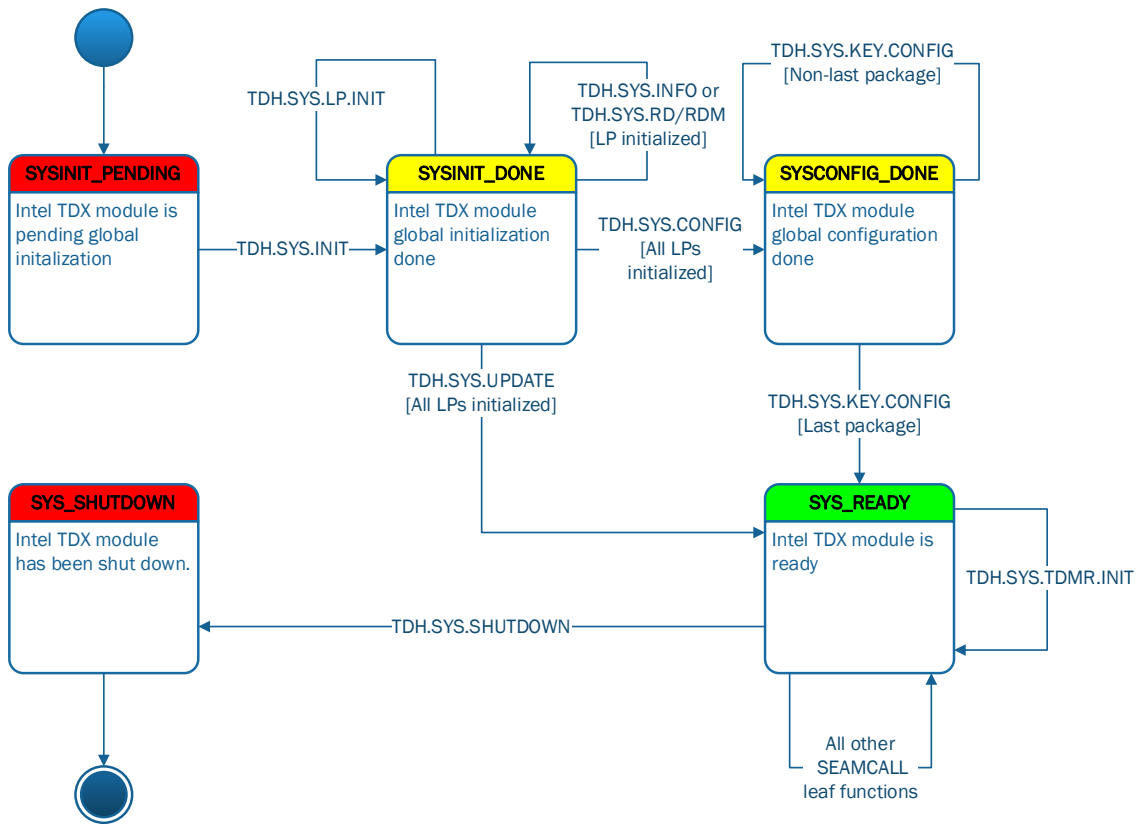

Figure 4.1: Intel TDX Module Lifecycle State Machine

Table 4.1: UPDATED: Intel TDX Module Lifecycle States

State Name	Description	Allowed SEAMCALL Leaf Functions
SYSINIT_PENDING	TDH.SYS.INIT has not been called yet.	TDH.SYS.INIT TDH.SYS.LP.SHUTDOWN
SYSINIT_DONE	TDH.SYS.INIT has completed successfully. TDH.SYS.LP.INIT must be called on each LP.	TDH.SYS.LP.INIT TDH.SYS.RD* (if current LP has been initialized) TDH.SYS.INFO (if current LP has been initialized) TDH.SYS.CONFIG (if all LPs have been initialized) TDH.SYS.LP.SHUTDOWN TDH.SYS.UPDATE (if all LPs have been initialized)

SYSCONFIG_DONE	TDH.SYS.CONFIG has completed successfully. TDH.MNG.KEY.CONFIG must be called on each package.	TDH.SYS.KEY.CONFIG TDH.SYS.RD* TDH.SYS.INFO TDH.SYS.LP.SHUTDOWN
SYS_READY	The Intel TDX module is ready for use.	Any
SYS_SHUTDOWN	Shutdown operation has been initiated. No new host-side interface functions can be called.	None

4.1.2. Platform Compatibility and Configuration Checking

4.1.2.1. Overview

The Intel TDX module is built assuming a certain set of core and platform features. Most platform configuration required to support the Intel TDX module is checked by MCHECK. However, some configuration is designed to be checked by the Intel TDX module. During the initialization process, the Intel TDX module is designed to check that the platform on which it is running is compatible with this core and platform feature set and/or that the same set of features is provided across the platform. Some of the checks are done per core, and some are done per package. Most of the details are part of the Intel TDX module detailed design.

4.1.2.2. CPU Configuration

During platform boot, MCHECK verifies all logical CPUs to ensure they meet TDX's security and certain functionality requirements, and MCHECK passes the following CPU configuration information to the NP-SEAMLDR, P-SEAMLDR and the TDX Module:

- Total number of logical processors in the platform.
- Total number of installed packages in the platform.
- A table of per-package CPU family, model and stepping etc. identification, as enumerated by CPUID(1).EAX.

The above information is static and does not change after platform boot and MCHECK run.

Note: TDX doesn't support adding or removing CPUs from TDX security perimeter, as checked by MCHECK. BIOS should prevent CPUs from being hot-added or hot-removed after platform boots.

The TDX module performs additional checks of the CPU's configuration and supported features, by reading MSRs and CPUID information as described in the following sections.

4.1.2.3. MSR Sampling and Checks

TDH.SYS.INIT reads and checks the contents of some MSRs. In many cases, the MSR value read by TDH.SYS.INIT is also checked for consistency (i.e., having the same values) by TDH.SYS.LP.INIT. In other cases, TDH.SYS.LP.INIT may perform additional checks.

4.1.2.4. **UPDATED:** CPUID Sampling, Checks and Enumeration

Note: CPUID virtualization is described in 11.8.

The TDH.SYS.INIT and TDH.SYS.LP.INIT functions sample CPUID leaf and sub-leaf return values. This is intended to check compatibility with the Intel TDX module and with any guest TD operation. If any of these checks fail, Intel TDX module initialization is designed to fail.

The **TDH.SYS.RD**, **TDH.SYS.RDALL** and **TDH.SYS.INFO** functions may be called by the host VMM to enumerate the directly configurable and allowable CPUID fields.

4.1.3. Physical Memory Configuration Overview

Configuration of the physical memory available to the Intel TDX module (TDMRs) and its associated metadata (PAMT arrays) is done using the TDH.SYS.CONFIG function.

4.1.3.1. Intel TDX ISA Background: Convertible Memory Ranges (CMRs)

- 5 A 4KB memory page is defined as **convertible** if it can be used to hold an Intel TDX private memory page or any Intel TDX control structure pages while helping guarantee Intel TDX security properties (i.e., if it can be **converted** from a Shared page to a private page).

10 **Convertible Memory Ranges (CMRs)** are defined as contiguous convertible physical address ranges, declared by BIOS. CMRs are checked by MCHECK during platform boot to help ensure their configuration matches TDX security. All memory within each CMR must be convertible and must be present when checked by MCHECK during platform boot. CMRs are static and do not change after platform boot and checking by MCHECK.

Note: The above definition implies that TDX does not support hot-plugin or hot-removal of convertible memory. BIOS should prevent hot removal of convertible memory after platform boot.

CMRs have the following characteristics:

- 15
- CMR configuration is “soft” – no hardware range registers are used.
 - Each CMR defines a single contiguous physical address range.
 - All the memory within each CMR is convertible, and it must comply with the rules checked by MCHECK.
 - Each CMR has its own size. CMR size is a multiple of 4KB, and it is **not** required to be a power of two.
 - CMRs cannot overlap with each other.

20

 - CMRs must reside within the effective physical address range of the platform (after taking into account the most significant PA bits stolen for Key IDs).
 - CMRs are configured at platform scope (no separate configuration per package).
 - The maximum number of CMRs is implementation specific. It is not explicitly enumerated; it is deduced from Family/Model/Stepping information provided by CPUID.
 - The maximum number of CMRs is 32.

25

 - CMRs are available on systems with TDX ISA capabilities, as enumerated by bit 5 of the IA32_VMX_PROCBASED_CTL3 MSR.
 - CMR configuration is checked by MCHECK and cannot be modified afterwards.

30 MCHECK stores the CMR table, and other platform topology information, in a pre-defined location in SEAM range, so it can be read later and trusted by the P-SEAMLDR module. On TDX module installation, P-SEAMLDR copies MCHECK data to another page in the SEAM range, which is accessible by the Intel TDX module.

4.1.3.2. TDMRs and PAMT Arrays Configuration

TDMRs and PAMTs are described in 8.1. This section provides an overview of their configuration and their relationships to CMRs.

35 4.1.3.2.1. Background: Reserved Areas within TDMRs

As described in 8.1, the Intel TDX module physical memory management is done using PAMT Blocks – each holding the metadata of a 1GB block of TDMR. This implies that TDMR granularity must be 1GB.

However, there is a requirement for the host VMM to be able to allocate memory at granularities smaller than 1GB. This is especially important in systems that have a relatively small amount of memory.

40 To support the two requirements above, the Intel TDX module’s design allows arbitrary reserved areas within TDMRs. Reserved areas are still covered by PAMT. However, during initialization their respective PAMT entries are marked with a PT_RSVD page type, so pages in reserved areas are not used by the Intel TDX module for allocating privately encrypted memory pages (but they can be used for PAMT areas, see below).

Only the non-reserved parts of a TDMR are required to be inside CMRs.

45 4.1.3.2.2. Background: Three PAMT Areas

As described in 8.1, a logical PAMT Block is composed of 1 PAMT_1G entry, 512 PAMT_2M entries and 512² PAMT_4K entries. Thus, the overall size of a PAMT Block, and as a result of the whole PAMT, is not a power of 2.

However, the host VMM may only be able to allocate memory buffers for PAMT in sizes that are a power of 2.

To enable this, buffers for PAMT_1G entries, PAMT_2M entries and PAMT_4K entries are allocated separately. As a result, if the host VMM allocates a TDMR whose size is a power of 2, its three respective PAMT areas will also have sizes that are a power of 2.

PAMT areas are required to be inside CMRs because PAMT is encrypted with a private HKID.

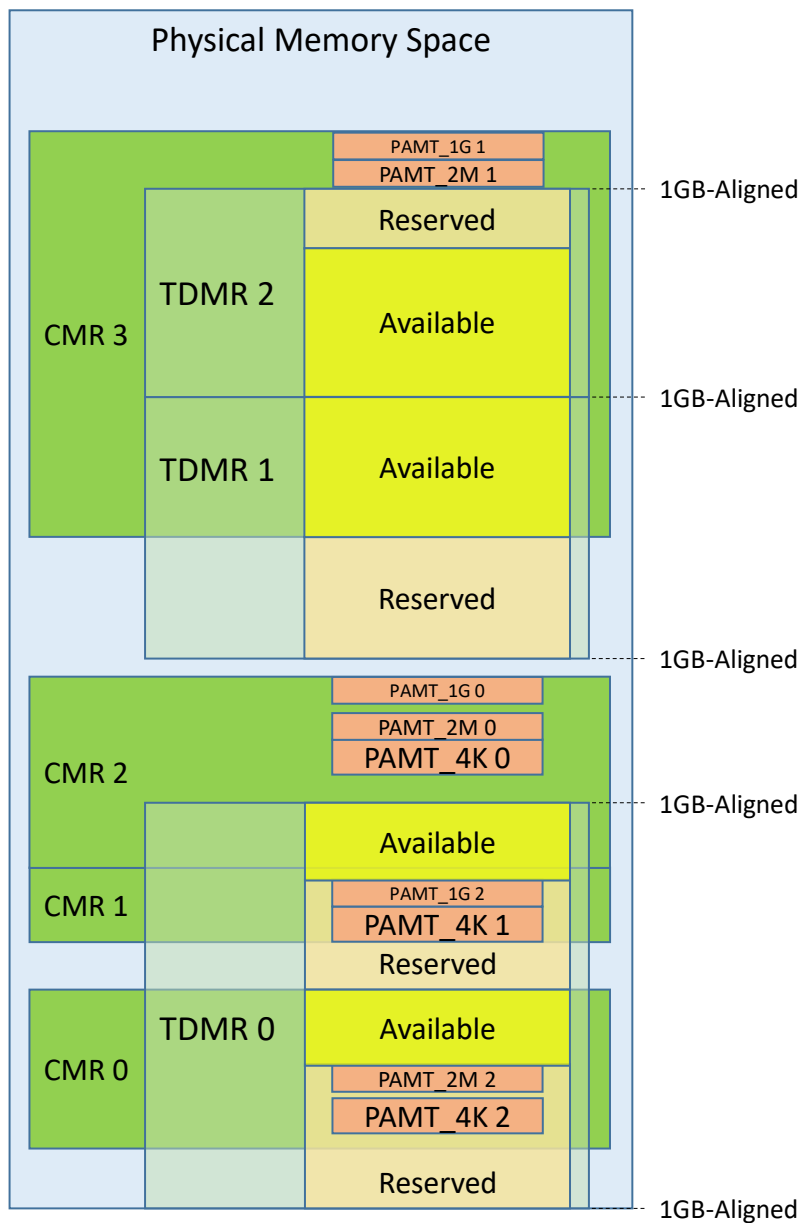

Figure 4.2: Example of Convertible Memory Ranges (CMRs) vs. Trust Domain Memory Regions (TDMRs)

4.1.3.2.3. **UPDATED:** Configuration Rules

In addition to the rules described in 8.1, the following rules apply to TDMR configuration as related to CMRs:

- Any non-reserved 4KB page within a TDMR must be convertible – i.e., it must be within a CMR.
- Reserved areas within a TDMR need not be within a CMR.

Three PAMT areas must be configured for each TMDR – one for each physical page size controlled by PAMT:

- Area for PAMT_4K entries
- Area for PAMT_2M entries
- Area for PAMT_1G entries

PAMT areas have the following attributes:

- A PAMT area size is directly proportional to the TDMR with which it is associated. The size ratio is enumerated by TDH.SYS.RD/RDALL or TDH.SYS.INFO. **Note that the size ratio may be different for each of the 3 PAMT array types.**

- A PAMT area must reside in convertible memory – i.e., each PAMT area page must be a CMR page.
- PAMT areas must not overlap with TDMR non-reserved areas; however, they may reside within TDMR reserved areas (as long as these are convertible).
- PAMT areas must not overlap with each other.

5 4.2. Intel TDX Module Initialization Interface

4.2.1. Global Initialization: TDH.SYS.INIT

TDH.SYS.INIT is intended to globally initialize the Intel TDX module. It works as follows:

1. Initialize Intel TDX module global data.
2. Sample and check platform features that need to be checked for platform-wide compatibility – i.e., the Intel TDX module supports several options, but they must be the same across platform. These are later checked on each LP.
3. Sample and check the platform configuration on the current LP. For example, TDH.SYS.INIT samples SMRR and SMRR2, checks they are locked and do not overlap any CMR, and stores their values to be checked later on each LP.
4. Set the system state to SYSINIT_DONE.

For a detailed description of TDH.SYS.INIT, see the [TDX Module ABI Spec].

15 4.2.2. LP-Scope Initialization: TDH.SYS.LP.INIT

TDH.SYS.LP.INIT is intended to perform LP-scope, core-scope and package-scope initialization of the Intel TDX module. It can be called only after TDH.SYS.INIT completes successfully, and it can run concurrently on multiple LPs. At a high level, TDH.SYS.LP.INIT works as follows:

1. Do a global EPT flush (INVEPT type 2).
2. Initialize Intel TDX module LP-scope data.
3. Check features and configuration compatibility and uniformity – once per LP, core or package, depending on the scope of the checked feature or configuration:
 - 3.1. Check features compatibility with the Intel TDX module.
 - 3.2. Check configuration uniformity.

25 For a detailed description of TDH.SYS.LP.INIT, see the [TDX Module ABI Spec].

4.2.3. UPDATED: TDX Module Enumeration: TDH.SYS.RD/RDALL and TDH.SYS.INFO

Once an LP has been initialized, the host VMM can call TDH.SYS.RD, TDH.SYS.RDALL or TDH.SYS.INFO on that LP to help enumerate the Intel TDX module capabilities and platform configuration.

30 TDH.SYS.RD and TDH.SYS.RDALL are the recommended enumeration methods. They enable the host VMM to read the values of TDX module global metadata fields, enumerating the TDX module capabilities. The list of fields is described in the [TDX Module ABI Spec].

To read all host readable TDX Module fields, the host VMM can invoke TDH.SYS.RDALL. This function returns the information as a metadata list.

35 To read a single TDX Module field, TDH.SYS.RD can be invoked. It returns the next host-readable field identifier, thus it can also be used to enumerate the TDX Module by calling it in a loop, starting from field identifier value of 0, until it returns a next field identifier value of 0.

TDH.SYS.INFO is provided for backward compatibility with previous TDX module versions:

- Intel TDX module capabilities are enumerated in the returned TDSYSINFO_STRUCT (see the [TDX Module ABI Spec]).
- Convertible Memory Ranges (CMRs), as previously set by BIOS and checked by MCHECK, are enumerated in the returned CMR_INFO table.

40 For a detailed description of interface functions and metadata fields, see the [TDX Module ABI Spec].

4.2.4. Global Configuration: TDH.SYS.CONFIG

After performing global and LP-scope initialization, the host VMM can call TDH.SYS.CONFIG to globally configure the Intel TDX module, providing the following information:

- **TDMR and PAMT Table**, where each entry contains a TDMR base address, size and corresponding PAMT reserved area base address and size. Refer to 8.1 for definition of TDMRs.
- The **HKID** to be used by the Intel TDX module for its global private key, used for encrypting PAMT and TDRs.

For a detailed description of the table format (TDMR_INFO) and TDH.SYS.CONFIG, see the [TDX Module ABI Spec].

4.2.5. Package-Scope Key Configuration: TDH.SYS.KEY.CONFIG

After performing global configuration, the host VMM calls TDH.SYS.KEY.CONFIG to perform package-scope configuration of the Intel TDX module's global private key on the hardware.

For a detailed description of TDH.SYS.KEY.CONFIG, see the [TDX Module ABI Spec].

4.2.6. State Restoration after TD-Preserving TDX Module Update: TDH.SYS.UPDATE

When updating the TDX module, the host VMM can call TDH.SYS.UPDATE after initializing the new TDX module on all LPs, so that the new TDX module will update itself with the handoff data prepared by a call to the TDH.SYS.SHUTDOWN API on the previous TDX module. This allows "old" TDs, which were created by previous TDX module(s), to keep running under the supervision of the new TDX module.

If TDH.SYS.UPDATE returns successfully, the TDX module is ready, and TDH.SYS.CONFIG and TDH.SYS.KEY.CONFIG cannot (and need not) be called anymore. If TDH.SYS.UPDATE is not called, or returns error, then TDH.SYS.CONFIG and TDH.SYS.KEY.CONFIG should be called; in that case, old TDs – if any – are not preserved.

Note: TD-preserving interface functions (TDH.SYS.UPDATE and TDH.SYS.SHUTDOWN) are available only on platforms with ISA support for TD-Preserving Module updates. The host VMM can enumerate whether these APIs are available by using TDH.SYS.RD* to read the TDX_FEATURES0 field and checking whether the "TD-Preserving" bit returns '1.

For a detailed description of TDH.SYS.UPDATE, see the [TDX Module ABI Spec].

4.3. TDMR and PAMT Initialization

TDMR and PAMT initialization procedure is designed to be performed **during VMM run-time**, after VMM boot. The host VMM should be able to work normally while initialization takes place, at any time using memory that has already been initialized. At a high level, TDMR initialization has the following characteristics:

- Initialization is performed gradually.
- Initialization function TDH.SYS.TDMR.INIT adheres to the latency rules of most Intel TDX functions – i.e., they take no more than a predefined number of clock cycles.
- Initialization function TDH.SYS.TDMR.INIT **can run concurrently on multiple LPs** if each concurrent flow initializes a **different TDMR**.
- After each 1GB page of a TDMR has been initialized, that 1GB page becomes available for use by any Intel TDX function that creates a private TD page or a control structure page – e.g., TDH.MEM.PAGE.ADD, TDH.VP.ADDCX, etc.

For each TDMR, the VMM should execute a loop of **TDH.SYS.TDMR.INIT** providing the TDMR start address (at 1GB granularity) as an input.

TDH.SYS.TDMR.INIT initializes an (implementation-defined) number of PAMT entries. The maximum number of PAMT entries to be initialized is designed to avoid latency issues. Initialization uses direct writes (MOVDIR64B).

Once the PAMT for each 1GB block of TDMR has been fully initialized, TDH.SYS.TDMR.INIT marks that 1GB block as ready for use; that means 4KB pages in this 1GB block may be converted to private pages – e.g., by TDH.MEM.PAGE.ADD. This can be done concurrently with adding and initializing other TDMRs.

For a detailed description of TDH.SYS.TDMR.INIT, see the [TDX Module ABI Spec].

4.4. Intel TDX Module Shutdown

4.4.1. Shutdown Initiated by the Host VMM (as Part of Module Update)

The host VMM can initiate Intel TDX module shutdown at any time by calling the TDH.SYS.SHUTDOWN function. This is intended for use as part of updating the Intel TDX module without going through a warm or cold reset sequence. TDH.SYS.SHUTDOWN is designed to set state variables to block all SEAMCALL leaf functions.

TDH.SYS.SHUTODWN also prepares handoff data in a designated area in SEAM range called handoff data range. The handoff data contains any TDX module state (in SEAM range) required to preserve old TDs across TDX module updates. This includes (but not limited to) Key Ownership Table (KOT) and TDMR management table. When a new TDX module is installed using the “update” scenario, the P-SEAMLDR module preserves (doesn’t wipe-out) the handoff data range. The new TDX module can then update itself (when the TDH.SYS.UPDATE function is called) from that handoff data.

4.4.2. Shutdown Initiated by a Fatal Error

By design, fatal errors during Intel TDX module execution cause an immediate SEAM shutdown. Subsequent SEAMCALLs on any LP fail with a VMfailInvalid indication (RFLAGS.CF set to 1). This situation can only be recovered by a platform reset.

4.5. Intel TDX Module Handoff Data

In order to preserve TDs across Intel TDX module updates, the old TDX module’s TDH.SYS.SHUTDOWN function prepares handoff data in the handoff data region, to be consumed by the new TDX module’s TDH.SYS.UPDATE function. The handoff data contains all variables maintained inside SEAM range (i.e., module’s global and local data) related to TD management. Note that TD code, data and metadata pages residing out of SEAM range need not be passed, since the DRAM contents and MKTME state are not impacted.

Since it’s possible – and normally expected – that the new TDX module would differ from the old TDX module it’s replacing, it’s necessary that the new TDX module will understand the syntax and semantics of all TD metadata – either in the handoff data range and out of SEAM range – that the old TDX module left behind, including PAMT, Secure EPTs, TDRs, TDCS and TDVPS pages. To support that, a handoff protocol is needed.

The handoff protocol is based on the notion of **Handoff Version (HV)** – an unsigned 16-bit number which identifies the contents, syntax and semantics of all TD metadata fields, in the handoff data region and out of SEAM range, that the old TDX module passes to the new TDX module. The TDX module may understand one or more HVs. This allows the new module to consume handoff data prepared by an older TD module and “upgrade” it with new contents (e.g., put data in TDVPS fields that were previously reserved).

In preparation to TD-preserving TDX module update, the host VMM calls the TDH.SYS.SHUTDOWN function with “requested HV” parameter. If the TDX module understands the requested HV and was not built as “non-downgradable” (see below), then the TDH.SYS.SHUTDOWN prepares handoff data with the requested syntax and semantics in the handoff data region; it marks the handoff data region as valid with the requested HV (see [P-SEAMLDR FAS] for the structure of the 64-bit handoff data region’s header that contains this information).

After P-SEAMLDR updated the TDX module in SEAM range, the host VMM initializes the new TDX module, and calls its TDH.SYS.UPDATE function which consumes the handoff data and marks it as invalid.

Specifically, each TDX module is built with the following constants:

Table 4.2: TDX Module Handoff Constants

Name	Meaning	Description
MODULE_HV	Module Handoff Version	Handoff version that this TDX module works with
MIN_UPDATE_HV	Minimum Updatable Handoff Version	The “oldest” HV this TDX module understands
NO_DOWNGRADE	No-Downgrade Flag	A non-zero value indicates that this TDX module cannot “downgrade” the data it leaves behind to a lower handoff version

The above constants must satisfy the inequality $0 \leq \text{MIN_UPDATE_HV} \leq \text{MODULE_HV}$. If $\text{MIN_UPDATE_HV} < \text{MODULE_HV}$, then this TDX module can consume (in TDH.SYS.UPDATE) older handoff data (i.e., data whose syntax/semantics has lower HV than the syntax/semantics this TDX module was built to work with). In addition, if the NO_DOWNGRADE flag is zero, then this TDX module can generate (in TDH.SYS.SHUTDOWN) older handoff data.

The following table illustrates this protocol with several examples.

Table 4.3: TDX Module Handoff Protocol Examples

Old TDX Module's Parameters	New TDX Module's Parameters	Requested HV to Old TDX Module's TDH.SYS.SHUTDOWN	HV of Handoff Data Prepared by Old TDX Module	Module Update by P-SEAMLDR	New TDX Module's TDH.SYS.UPDATE Action
MODULE_HV=10 MIN_UPDATE_HV=10 NO_DOWNGRADE=0	MODULE_HV=10 MIN_UPDATE_HV=10 NO_DOWNGRADE=0	10	10	Installed	Consume as is
MODULE_HV=10 MIN_UPDATE_HV=10 NO_DOWNGRADE=0	MODULE_HV=10 MIN_UPDATE_HV=10 NO_DOWNGRADE=0	11	None (shutdown failed – requested HV is too large)	Not installed (invalid handoff data) Note: the host VMM can install using "Load" scenario	Fail (invalid handoff data) Note: the host VMM should re-configure the new TDX module (TDs are not preserved)
MODULE_HV=10 MIN_UPDATE_HV=10 NO_DOWNGRADE=0	MODULE_HV=10 MIN_UPDATE_HV=10 NO_DOWNGRADE=0	9	None (shutdown failed – requested HV is too small)	Not installed (invalid handoff data) Note: the host VMM can install using "Load" scenario	Fail (invalid handoff data) Note: the host VMM should re-configure the new TDX module (TDs are not preserved)
MODULE_HV=10 MIN_UPDATE_HV=10 NO_DOWNGRADE=0	MODULE_HV=11 MIN_UPDATE_HV=10 NO_DOWNGRADE=0	10	10	Installed	Upgrade to 11 and consume
MODULE_HV=11 MIN_UPDATE_HV=10 NO_DOWNGRADE=0	MODULE_HV=10 MIN_UPDATE_HV=10 NO_DOWNGRADE=0	10	10 (downgraded)	Installed	Consume as is
MODULE_HV=11 MIN_UPDATE_HV=10 NO_DOWNGRADE=0	MODULE_HV=10 MIN_UPDATE_HV=10 NO_DOWNGRADE=0	11	11	Not installed (HV-incompatible module) Note: the host VMM can install using "Load" scenario.	Fail (invalid handoff data) Note: the host VMM should re-configure the new TDX module (TDs are not preserved).
MODULE_HV=11 MIN_UPDATE_HV=10 NO_DOWNGRADE=1	MODULE_HV=10 MIN_UPDATE_HV=10 NO_DOWNGRADE=0	10	Shutdown failure (can't downgrade)	Not installed (invalid handoff data) Note: the host VMM can install using "Load" scenario.	Fail (invalid handoff data) Note: the host VMM should re-configure the new TDX module (TDs are not preserved).

5. Memory Encryption Key Management

5.1. Objectives

The main goal of Intel TDX key management is to enable the VMM to perform the following:

- Manage HKID space as a limited platform resource, assigning HKIDs to TDs and reclaiming them as required.
- Enable the Intel TDX module to use a global ephemeral key for encrypting its data (e.g., PAMT).
- Enable each TD to use its own ephemeral key.

The Intel TDX interface functions are designed to provide the required building blocks and help ensure that software cannot perform operations that are not compliant with TDX security objectives, as follows:

1. Help ensure that only HKID values that have been configured for TDX private memory encryption keys can be assigned to TDs, and that those HKID values cannot be used by non-TD software or devices.
2. Prevent assignment of the same HKID to more than one TD.
3. At the time an HKID is assigned to a TD, there must be no modified cache lines – at any level, for any core, on any package – for that HKID. All such cache lines that may have held modified data have been written to memory (if required). Note that this requirement applies only to TDX private HKID and not to legacy MKTME HKIDs.
4. TD memory may be accessed, and the TD may run, only when the following conditions are met:
 - 4.1. An HKID has been assigned for the TD's ephemeral key.
 - 4.2. The encryption key has been configured for all the TD's ephemeral HKID, on all crypto engines, on all packages.

5.2. Background: HKID Space Partitioning

Since the same MKTME encryption engines and the same set of encryption keys are used for legacy MKTME operation and for TDX operation, TDX ISA enables the enumeration and partitioning of the activated HKID space between the two technologies. As designed, the encryption keys and their associated HKIDs are divided into three ranges, as shown in Table 5.1 below. The values of NUM_HKID_KEYS and NUM_TDX_PRIV_KEYS are read from the IA32_MKTME_KEYID_PARTITIONING MSR (0x87).

Private HKIDs and private keys are designed to be fully controlled by the Intel TDX module and are the subject of this chapter.

Table 5.1: HKID Space Partitioning

	HKID	Key
Shared HKIDs	0	Legacy TME key, shared
	1	Legacy MKTME key #1
	2	Legacy MKTME key #2

	NUM_HKID_KEYS	Last legacy MKTME key
Private HKIDs	NUM_HKID_KEYS + 1	Private key of a specific TD
	NUM_HKID_KEYS + 2	Private key of a specific TD
	NUM_HKID_KEYS + 3	Private key of a specific TD

	NUM_HKID_KEYS + NUM_TDX_PRIV_KIDS	Private key of a specific TD

5.3. Key Management Tables

The CPU and the Intel TDX module maintain several tables for key management. No table is intended to be directly accessible by software; the tables are used by the Intel TDX functions. The tables help the Intel TDX module track the proper operation of the software and help achieve the Intel TDX security objectives.

Table 5.2: Key Management Tables

Table	Scope	Description
Key Encryption Table (KET)	Package	<p>KET is an abstraction of the CPU micro-architectural hardware table for configuring the memory encryption engines. The KET is indexed by HKID. All crypto engines on a package are configured the same way.</p> <p>KET is part of the legacy MKTME architecture. Intel TDX ISA partitions KET to shared and private ranges, as described in 5.2 above.</p> <ul style="list-style-type: none"> • A KET entry in private HKIDs range is configured per package by the host VMM using the SEAMCALL(TDH.MNG.KEY.CONFIG) function. • A KET entry in the shared HKID range is configured by software per package directly, using the PCONFIG instruction.
KeyID Ownership Table (KOT)	Platform	<p>KOT is an Intel TDX module hidden table for managing the TDX HKIDs inventory. It is used for assigning HKIDs to TDs, revoking HKIDs from TDs and controlling cache flush.</p> <p>KOT is indexed by HKID.</p>
TD Key Management Fields	TD	<p>TD-scope key management fields are held in TDR. They include the key state, ephemeral private HKID and key information, and a bitmap for tracking key configuration.</p>

Figure 5.1 below provides an abstract, high-level picture of how the tables are related. Detailed discussion is provided in the following sections.

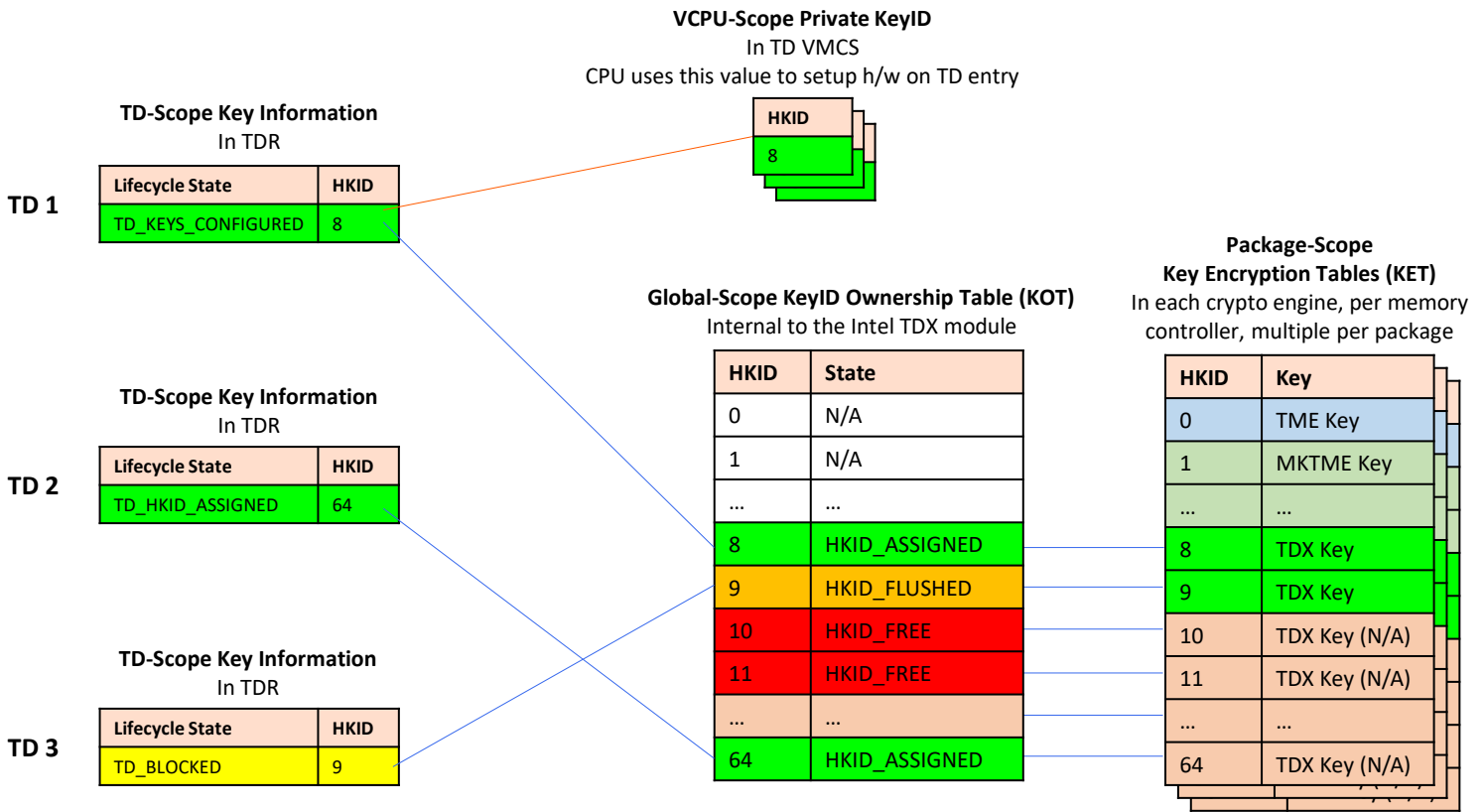

Figure 5.1: Overview of the Key Management State at TD-Scope, LP-Scope, Package-Scope and Global-Scope

5.4. Combined Key Management State

Key management state is composed of two state variables:

- **Per-HKID KOT Entry State** is designed to control how the inventory of private HKIDs is managed using the KOT.
- **Per-TD Life Cycle State** is designed, among other things, to control how TD keys are configured on the hardware and the process of shutting down a TD.

The combined key management state is intended to affect whether the TD private memory is accessible, whether its contents may be cached, whether private GPA-to-HPA address translations are allowed and whether such translations may be cached.

Table 5.3 below lists the designed combined key management state values and their meaning. Figure 5.2 below shows a simplified diagram of the combined key state. Refer also to the key management sequences described in 5.5.

Table 5.3: Combined TD Key Management States

TD Life Cycle State	KOT Entry (HKID) State	Private Memory Access		S-EPT Translations		Comments
		New	Cached	New	Cached	
N/A	HKID_FREE	No	No	No	No	HKID not assigned to TD
TD_HKID_ASSIGNED	HKID_ASSIGNED	No	No	No	No	TD private key not configured
TD_KEYS_CONFIGURED		TD	TD	TD	TD	TD build and execution
TD_BLOCKED	HKID_FLUSHED	No	TD	No	No	TD private memory access is blocked, TD may not run
TD_TEARDOWN	N/A (HKID_FREE)	No	No	No	No	TD has no HKID
N/A	HKID_RESERVED	Global	Global	N/A	N/A	HKID for Intel TDX global data

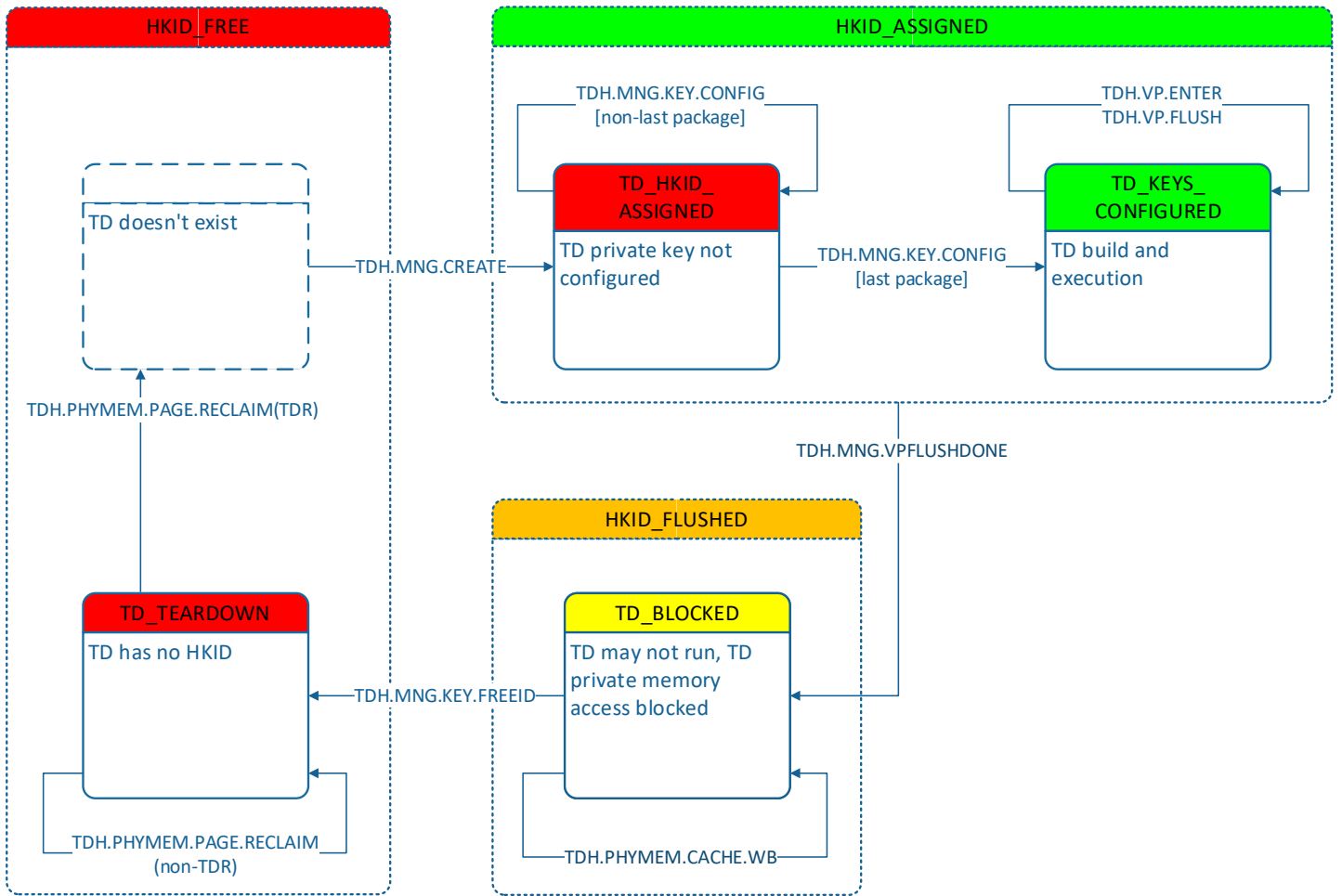

Figure 5.2: Simplified Combined TD Key Management State Diagram

Chapter 7 discusses TD life cycle management and zooms-in into the TD_KEYS_CONFIGURED state, detailing its secondary sub-states that control TD operation and TD migration.

5.5. Key Management Sequences

5.5.1. Intel TDX Module Initialization: Setting an Ephemeral Key and Reserving an HKID for Intel TDX Data

This sequence is described as part of the Intel TDX module initialization sequence in 3.1.

5.5.2. TD Creation, Keys Assignment and Configuration

This sequence is intended to be used by the host VMM to create a new TD, select HKIDs from the global pool in KOT and assign them to the TD, and configure the TD keys on the hardware.

Refer also to the software flow discussion in 3.2.

Table 5.4: Typical TD Creation, Keys Assignment and Configuration (TD-Scope and KOT-Scope) Sequence

	Intel TDX Function	Scope	Execute On	Description
1	TDH.MNG.CREATE	TD	One LP	Assign the TD's private HKID.
2	TDH.MNG.KEY.CONFIG	TD	Each package and each TD key	Configure the TD's random ephemeral key on the package.

5.5.3. TD Keys Reclamation, TLB and Cache Flush

This sequence is intended to be used by the host VMM to reclaim the HKIDs assigned to a TD and return them to the global pool in KOT. At the end of this sequence, the HKIDs should be free to be assigned to another TD.

5 The cache flush operation is long. Since it is designed to run at global scope and is decoupled from any TD, the host VMM may choose to implement it in a lazy fashion, i.e., wait until a certain number of HKIDs in the KOT pool become RECLAIMED. This is especially important since TDH.PHYMEM.CACHE.WB operates on all cache lines regardless of HKID.

To avoid long latencies, TDH.PHYMEM.CACHE.WB is designed to be interruptible. The host VMM is expected to repeat the execution of this instruction until it returns a success indication.

Refer also to the software flow discussion in 3.4.

10

Table 5.5: Typical TLB and Cache Flush (TD-Scope and KOT-Scope) Sequence

	Intel TDX Function	Scope	Execute On	Description
As a preparation, the host VMM avoids any VCPU-specific SEAMCALL function (i.e., TDH.VP.ENTER, TDH.VP.INIT, TDH.VP.RD and TDH.VP.WR) and waits until no VCPU is running.				
1	TDH.VP.FLUSH	TD VCPU	One each LP associated with a TD VCPU	Flush the VCPU's TD VMCS to TDVPS memory and flush the VCPU's TLB ASID.
2	TDH.MNG.VPFLUSHDONE	TD, KOT	One LP	Check all the VCPUs have been flushed.
3	TDH.PHYMEM.CACHE.WB	KOT	Each package or core ⁴	Write back cache hierarchy, at least for the HKIDs marked as TLB_FLUSHED. The instruction execution time is long; it is interruptible by external events and may be restarted until completed.
4	TDH.MNG.KEY.FREEID	TD, KOT	One LP	Mark TD's HKID as FREE.

⁴ Enumerated by CPU during Intel TDX module initialization, see 4.1.2.4.

6. UPDATED: TD Non-Memory State (Metadata) and Control Structures

This chapter discusses the guest TD control structures that hold non-memory state (metadata) and how they are intended to be used during the TD life cycle.

6.1. Overview

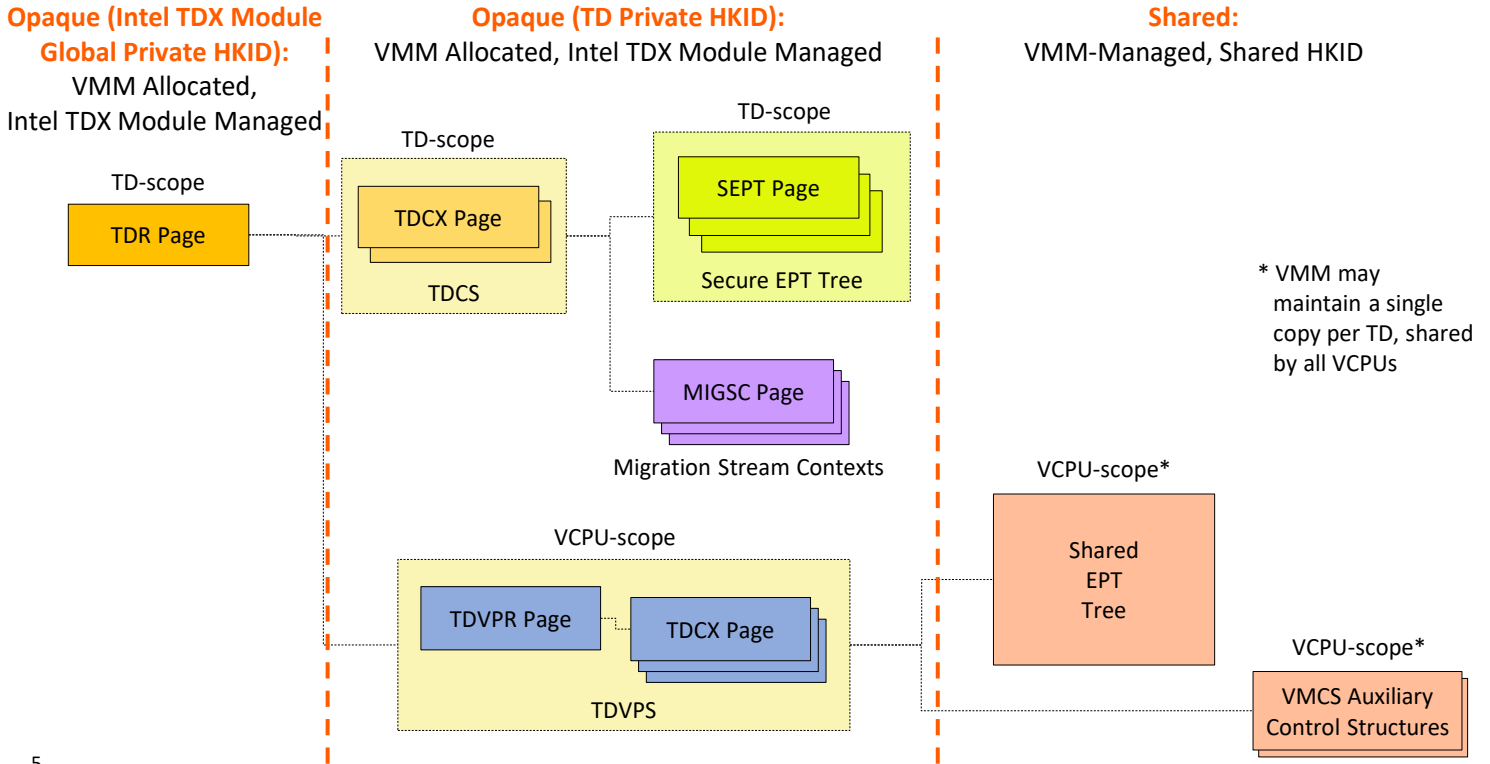

Figure 6.1: UPDATED: Guest TD Control Structures Overview

All guest TD control structures reside in memory pages that are allocated by the host VMM from the pre-configured TDMRs. Guest TD control structure pages are addressable by the host VMM.

6.1.1. Opaque vs. Private vs. Shared Control Structures

Control structures are divided to two classes:

- **Shared control structures** are intended to be directly managed by the host VMM and are encrypted with a shared HKID. The Intel TDX module architecture only describes the shared control structures that might directly impact its operation. The host VMM may hold additional control structures.
- **Private control structures** are mapped to the guest TD's GPA space and are directly accessible by it.
- **Opaque control structures** are not intended to be directly accessible to any software (except the Intel TDX module) or DMA. They are intended to be managed via Intel TDX module functions. Generally speaking, the host VMM is not aware of the exact format of opaque control structures. Opaque control structures' memory pages are intended to be encrypted with a private HKID.

6.1.2. Scope of Control Structures

Guest TD control structures have two possible scopes:

- **TD-scope control structures** are intended to apply for a guest TD as a whole.
- **TD VCPU-scope control structures** are intended to apply for a single virtual CPU of a guest TD.

6.2. TD-Scope Control Structures

TD-scope control structures include TDR and TDCS, discussed below, and Secure EPT, discussed in Chapter 9.

6.2.1. TDR (Trust Domain Root)

TDR is the root control structure of a guest TD. As designed, TDR is encrypted using the Intel TDX global private HKID. It holds a minimal set of state variables that enable guest TD control even during times when the TD's private HKID is not known, or when the TD's key management state does not permit access to memory encrypted using the TD's private key.

- 5 TDR occupies a single 4KB naturally aligned page of memory. It is designed to be the first TD page to be allocated and the last to be removed. Its physical address serves as a unique identifier of the TD, as long as any TD page or control structure resides in memory.

At a high level, TDR holds the following information:

- Fields designed to control guest TD build and teardown process.
- 10 • Fields designed to manage memory encryption keys.

6.2.2. **UPDATED:** TDCS (Trust Domain Control Structure)

TDCS is the main control structure of a guest TD. As designed, TDCS is encrypted using the guest TD's ephemeral private key. TDCS is a multi-page logical structure composed of multiple TDCX physical pages.

At a high level, TDCS holds the following information:

- 15 • Fields designed to control the TD operation as a whole (e.g., a counter of the number of VCPUs currently running).
- Fields designed to control the TD's execution control (debuggability, CPU features available to the TD, etc.).
- Fields related to TD measurement.
- EPTP: as designed, a pointer (HPA) to the TD's secure EPT root page and EPT attributes.
- MSR bitmaps, designed to be used by all the TD's VCPUs.
- 20 • As designed, the secure EPT root page.
- A page filled with zeros, designed to be used in cases where the Intel TDX module needs a read-only constant-0 page encrypted with the TD's private key.

TDCS may hold forward links to the following control structures:

- Secure EPT pages.
- 25 • Migration Stream Context (MIGSC) pages.

6.3. TD VCPU-Scope Control Structures

6.3.1. Trust Domain Virtual Processor State (TDVPS)

Trust Domain Virtual Processor State (TDVPS) is the root control structure of a TD VCPU. It helps the Intel TDX module control the operation of the VCPU and holds the VCPU state while the VCPU is not running. TDVPS is a single logical control structure composed of multiple physical 4KB pages.

30

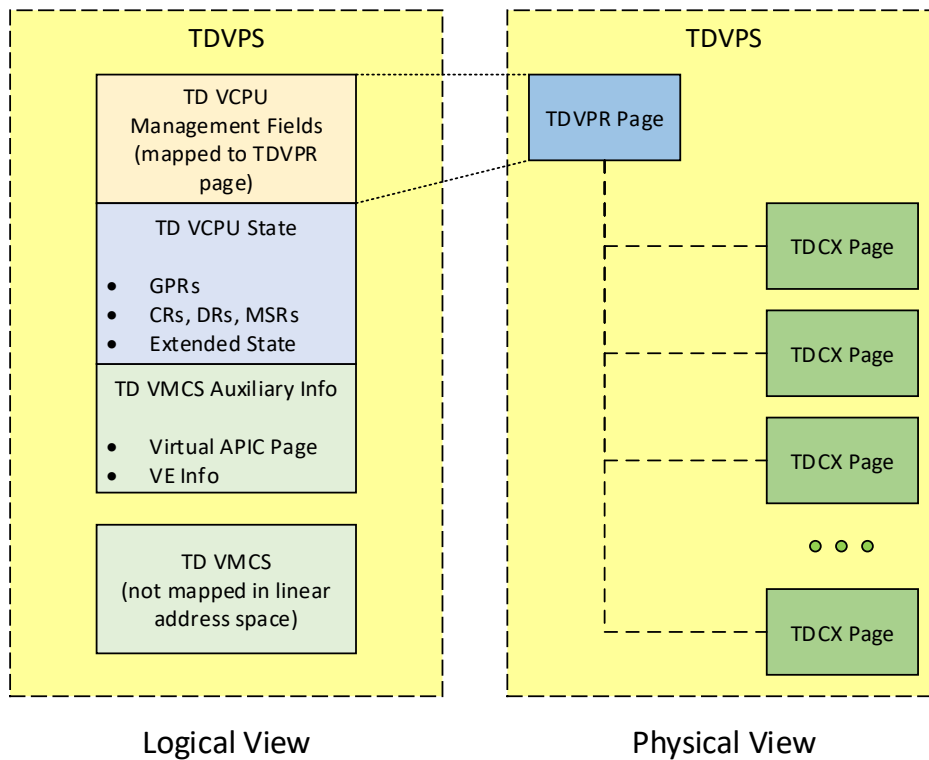

Figure 6.2: High Level Logical and Physical View of TDVPS

6.3.1.1. **UPDATED:** Physical View of TDVPS: TDVPR/TDCX

TDVPS is designed to be opaque to software and DMA access, accessible only by using the Intel TDX module functions. From the VMM perspective, TDVPS is composed of multiple 4KB pages, where each page may reside in arbitrary locations in convertible memory.

Trust Domain Virtual Processor Root (TDVPR) is the 4KB root page of TDVPS. Its physical address serves as a unique identifier of the VCPU (as long as it resides in memory).

Trust Domain Control structure eXtension (TDCX) 4KB pages extend TDVPR to help provide enough physical space for the logical TDVPS structure.

The TDVPR and TDCX pages are designed to be encrypted with the TD's ephemeral private key. They are addressable by the host VMM, which is responsible for allocating memory to hold them.

The required number of 4KB TDVPR/TDCX pages in TDVPS is enumerated to the VMM by the `TDH.SYS.RD*` or `TDH.SYS.INFO` function (see 4.2.3).

6.3.1.2. Logical View of TDVPS

Logically, TDVPS is organized as a single large data structure. At a high level, it is composed of the following parts:

VMX (with TDX ISA Extensions) Standard Control Structures

- TD VMCS
- TD VMCS auxiliary structures, such as virtual APIC page, virtualization exception information, etc. Note that MSR bitmaps are held as part of TDCS because they are meant to have the same value for all VCPUs of the same TD.

The TDX design does not require some of the VMX control structures (notably, the Shared EPT) to be protected. They are described below.

Proprietary Fields

- TD VCPU Management fields designed to manage the operation of the VCPU
- TD VCPU State fields designed to hold most of the VCPU state (except state that is saved to the TD VMCS) when the VCPU is not running

TDVPS organization and format are detailed in the [TDX Module ABI Spec].

6.3.2. Non-Protected Control Structures: Shared EPT and VMCS Auxiliary Control Structures

Several VMX control structures are directly managed and accessed by the host VMM. These control structures are pointed to by fields in the TD VMCS. The Intel TDX module checks that the pointers conform to the shared-access HPA semantics (see 18.2.1.1).

5 Non-protected control structures include:

- Shared EPT tree
- Posted interrupt descriptor

6.4. Updated: TD Non-Memory State (Metadata) Access Functions

10 As set of interface functions is provided to enable host VMM and guest TD access to TD non-memory state (metadata). These functions employ **metadata abstraction**, using field code to abstract the actual control structure format. The generic metadata access interface mechanisms are described in 18.6.

Table 6.1: TD Non-Memory State (Metadata) Single Field Access Functions

Side	Scope	Control Structures	Intel TDX Functions
Host VMM (SEAMCALL)	TD	TDR and TDCS	TDH.MNG.RD, TDH.MNG.WR
	VCPU	TDVPS (including TD VMCS)	TDH.VP.RD, TDH.VP.WR
Guest TD (TDCALL)	TD	TDR and TDCS	TDG.VM.RD, TDG.VM.WR
	VCPU	TDVPS (including TD VMCS)	TDG.VP.RD, TDG.VP.WR

15 Access to control structure fields using the provided interface functions (down to the bit granularity, if required) depends on whether the TD is debuggable (ATTRIBUTES.DEBUG bit is 1) or not.

In many cases, control structure field access means more than just reading or writing the field content. For example:

- When a field that contains an HPA is written, its value is checked not to overlap the SEAMRR range.
- In some cases, there may be inter-dependency between fields. When such fields are written, multiple checks may need to be done and some actions may need to be taken.
- For some fields, the internal format and/or value may be different than what is visible externally.

For details about the TDX module's metadata access interface, see 18.6.

6.5. Concurrency Restrictions and Enforcement

A general description of concurrency restriction is provided in 18.1.

25 Normally, exclusive or shared access is acquired, if needed, for the typically short duration of function flows. A TD VCPU execution is an exception case. Shared access to TDCS and TDVPS is acquired on TD Entry and released on TD Exit. This implies that SEAMCALL(TDH.VP.ENTER) function, all TDCALL functions, and asynchronous TD Exit have implicit shared access to TDCS and TDVPS.

This mechanism helps protect running VCPUs against concurrent functions that may try to change their governing control structures.

7. UPDATED: TD Life Cycle Management

This chapter discusses guest TD life cycle management.

7.1. TD Life Cycle State Machine

The TD Life Cycle state machine controls the overall TD build, run-time and destruction process. It operates in conjunction with the HKID state machine, as described in 5.4. Figure 7.1 below shows the TD Life Cycle state diagram.

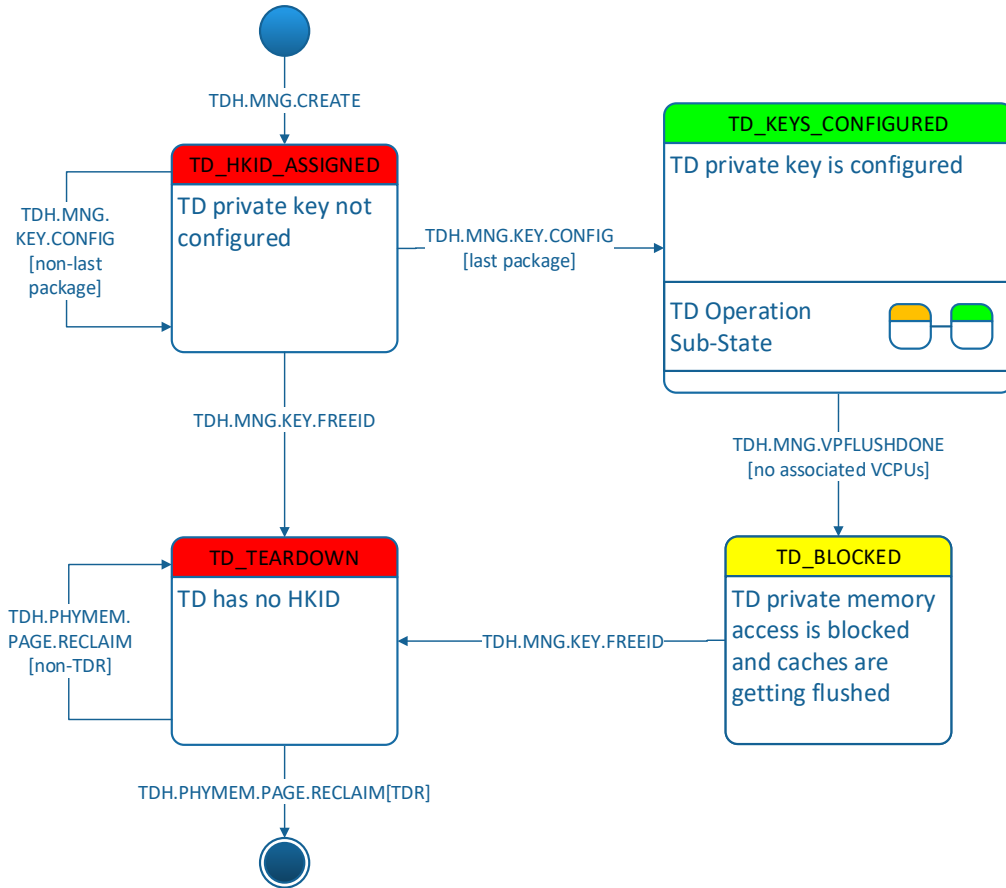

Figure 7.1: High-Level TD Life Cycle State Diagram

Most of the TD lifetime is spent in the TD_KEYS_CONFIGURED state. Within that state, a secondary-level state machine controls the overall TD operation and migration.

7.2. UPDATED: OP_STATE: TD Operation Secondary-Level State Machine

The TD Operation state machine controls sub-states of the TD Life Cycle’s TD_KEYS_CONFIGURED state. It shown in Figure 7.2 below. This document describes the baseline states: UNALLOCATED, UNINITIALIZED, INITIALIZED and RUNNABLE. Other states and transitions highlighted in red lines support TD migration and are described in the [TD Migration Spec].

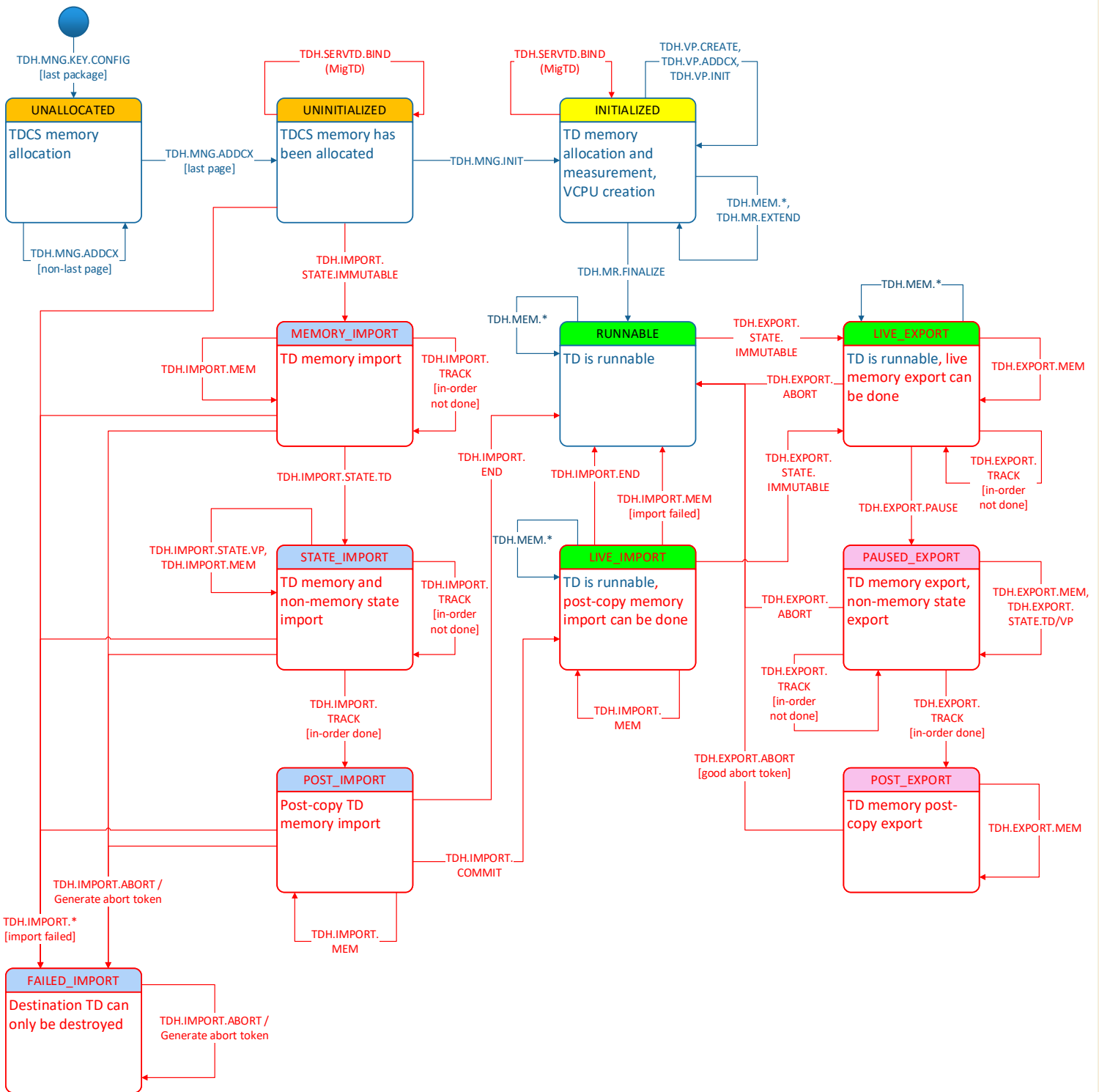

Figure 7.2: TD Operation State Machine (Sub-States of TD_KEYS_CONFIGURED)

7.3. TD Creation Sequence

The following sequence is intended to be used by the host VMM to create a new TD. Note that only the general aspects of TD creation are described here. Other aspects, such as key management, are described in other chapters.

Refer also to the software flow discussion in 3.2.

Table 7.1: Typical TD Creation Sequence

	Intel TDX Function	Inputs	Description
1	N/A	N/A	If any MODIFIED cache lines may exist for the physical pages to be written below (TDR, TDCS, Secure EPT root page), flush them to memory using, e.g., CLFLUSH (possibly on multiple LPs). This is required to avoid corruption due to cache line aliasing.
2	TDH.MNG.CREATE	TDR page PA	Create the TDR and generate the TD's random ephemeral key.
3	Multiple	See 5.5.2	Assign an HKID and configure the TD's random ephemeral key on all packages, as described in 5.5.2.
4	TDH.MNG.ADDCX (multiple)	<ul style="list-style-type: none"> Owner TDR PA TDCX page PA 	Run multiple times to add the required number of TDCX pages.
5	TDH.MNG.INIT	<ul style="list-style-type: none"> Owner TDR PA TD initialization parameters 	Initialize the TD state in TDR and TDCS.

At this point the TD is initialized. Private memory pages can be added as described in Chapter 9. VCPUs can be created and initialized as described below.

7.4. VCPU Creation and Initialization Sequence

VCPU creation and initialization is only allowed during TD build time.

- 5 The following sequence is intended to be used by the host VMM to create a new TD VCPU. After this sequence is done, the TD VCPU may be entered on an LP (assuming other conditions are met).

Refer also to the software flow discussion in 3.2.

Table 7.2: Typical TD VCPU Creation and Initialization Sequence

	Intel TDX Function	Inputs	Description
1	N/A	N/A	If any MODIFIED cache lines may exist for the physical pages to be written below (TDVPR, TDCX), flush them to memory (e.g., using CLFLUSH – possibly on multiple LPs). This is required to avoid corruption from cache line aliasing.
2	TDH.VP.CREATE	<ul style="list-style-type: none"> TDVPR page PA Owner TDR PA 	Create the VCPU and its TDVPR page.
3	TDH.VP.ADDCX (multiple)	<ul style="list-style-type: none"> TDCX page PA Parent TDVPR PA 	Run multiple times to add the required number of TDCX pages as an extension to a parent TDVPR.
4	TDH.VP.INIT	<ul style="list-style-type: none"> TDVPR PA VMM-provided identifier 	Initialize the VCPU state.

	Intel TDX Function	Inputs	Description
5	TDH.VP.WR	<ul style="list-style-type: none"> • TDVPR page PA • Field code • New field value • Write mask 	<p>The host VMM typically writes one or more of the following TD VCPU's VMCS controls:</p> <ul style="list-style-type: none"> • Shared EPTP • Posted-interrupts descriptor address, posted-interrupts notification vector and process posted interrupt • bus-lock detection • notification exiting and notify window <p>For details, see the [TDX Module ABI Spec].</p>

7.5. TD Teardown Sequence

The following sequence is intended to be used by the host VMM to tear down a TD. Note that only the general aspects of TD teardown are described here. Other aspects, such as key management, are described in other chapters. See also the discussion of physical page reclamation in 8.5.

Refer also to the software flow discussion in 3.4.

Table 7.3: Typical TD Teardown Sequence

	Intel TDX Function	Inputs	Description
1	Multiple	See 5.5.3	Reclaim the HKID, and flush TLB and cache, as described in 5.5.3.
2	TDH.PHYMEM.PAGE.RECLAIM (multiple)	TD page or control structure PA	Remove all TD private pages and control structure pages and mark them as PT_NDA in the PAMT.
3	TDH.PHYMEM.PAGE.RECLAIM	TDR PA	Remove the TDR page and mark it as PT_NDA in the PAMT.
4	TDH.PHYMEM.PAGE.WBINVD	TDR PA	Flush MODIFIED cache lines: this is required to avoid corruption due to cache line aliasing. Note that all cache lines for all other TD pages must have been flushed before the TDR page was reclaimed.

8. Physical Memory Management

This chapter describes how the Intel TDX module manages memory as a set of physical pages.

8.1. **UPDATED:** Trust Domain Memory Regions (TDMRs) and Physical Address Metadata

Tables (PAMTs)

5 **Trust Domain Memory Region (TDMR)** is defined as a range of convertible memory pages. TDMRs are set by the host VMM, based on the CMR information previously checked by MCHECK.

Each TDMR is defined as controlled by a (logically) single **Physical Address Metadata Table (PAMT)**. The PAMT structure is discussed in 8.3 below. PAMT tables reside in VMM-allocated memory, and they are designed to be encrypted with the Intel TDX global private HKID. The required size of PAMT memory, as a function of TDMR size, is enumerated to the 10 VMM by **TDH.SYS.RD/RDALL** or TDH.SYS.INFO.

Typically, after the host VMM initializes the Intel TDX module (TDH.SYS.INIT and TDH.SYS.LP.INIT), it configures the TDMRs and their respective PAMTs using TDH.SYS.CONFIG. It then would gradually initialize the TDMRs using TDH.SYS.TDMR.INIT. For a detailed description of the typical Intel TDX module initialization and configuration sequence, see Chapter 4.

15 8.2. **UPDATED:** TDMR Details

The following list includes definitions of the characteristics of a TDMR:

- TDMR configuration is "soft" – no hardware range registers are used.
- Each TDMR defines a single physical address range.
- Each TDMR has its own size which must be a multiple of 1GB. TDMR size is **not** required to be a power of two.
- 20 • A TDMR must be aligned on 1GB.
- TDMRs cannot overlap with each other.
- TDMRs may contain reserved areas. This effectively allows the host VMM to flexibly configure TDMRs based on the VMM's own consideration of system memory allocation – without being impacted by the 1GB granularity of the TDMR size.
- 25 ○ A reserved area must be aligned on 4KB, and its size must be a multiple of 4KB.
- The number of reserved areas that may be configured per TDMR is enumerated by **TDH.SYS.RD/RDALL** or TDH.SYS.INFO.
- TDMR memory, except for reserved areas, must be convertible as checked by MCHECK (i.e., every TDMR page must reside within a CMR).
- 30 • There is no requirement for TMDRs to cover all CMRs.
- TDMRs are configured at platform scope (no separate configuration per package).
- The maximum number of TDMRs is Intel TDX module implementation specific. It is enumerated to the host VMM using the **TDH.SYS.RD/RDALL** or TDH.SYS.INFO function, as described below.

8.3. **PAMT Details**

35 The Physical Address Metadata Table (PAMT) is designed to track the metadata of every physical page in TDMR. A page metadata includes page type, page size, assignment to a TD, and other attributes.

The PAMT is used by the Intel TDX module to help enforce the following properties:

- | | |
|----------------------------------|--|
| Page Attributes | A physical page in TDMR has a well-defined set of attributes, such as page type and page size. |
| Single TD Assignment | A physical page in TDMR can be assigned to at most one TD. |
| 40 Secure EPT Consistency | The page size of any private TD page, mapped in Secure EPT, matches its page size attribute in PAMT. |

8.3.1. PAMT Entry

Note: The description below is provided at a high level. Implementation details may differ.

45 A PAMT entry is designed to hold metadata for a single physical page. The page size may be 4KB, 2MB or 1GB depending on the PAMT level (see 8.3.2 below).

Table 8.1: High-Level View of a PAMT Entry

Field	Description
PT	PT indicates the type of page intended to be associated with this PAMT entry. See Table 8.3 below for details.
OWNER	OWNER is designed to contain bits 51:12 of the physical address of the TD's TDR page. This field can be applicable in all cases when a page is assigned to the Intel TDX module at this PAMT level or at a higher level. See Table 8.3 below for details.
BEPOCH	By design, the value of TDCS.TD_EPOCH as sampled by TDH.MEM.RANGE.BLOCK This field is intended to be applicable only if PT is PT_REG or PT_EPT. See 9.7 for a detailed discussion.

8.3.2. PAMT Blocks and PAMT Arrays

For each 1GB of TDMR physical memory, there is a corresponding **PAMT Block**. A PAMT Block is **logically** arranged in a three-level tree structure of **PAMT Entries**, as shown in Figure 8.1 below. Levels 0 through 2 (PAMT_4K, PAMT_2M and PAMT_1G) correspond to 4KB, 2MB and 1GB physical TDMR pages, respectively.

Physically, for each TDMR the design includes three arrays of PAMT entries, one for each PAMT level. This aims to simplify VMM memory allocation. A logical PAMT Block has one entry from the PAMT_1G array, 512 entries from the PAMT_2M array, and 512² entries from the PAMT_4K array.

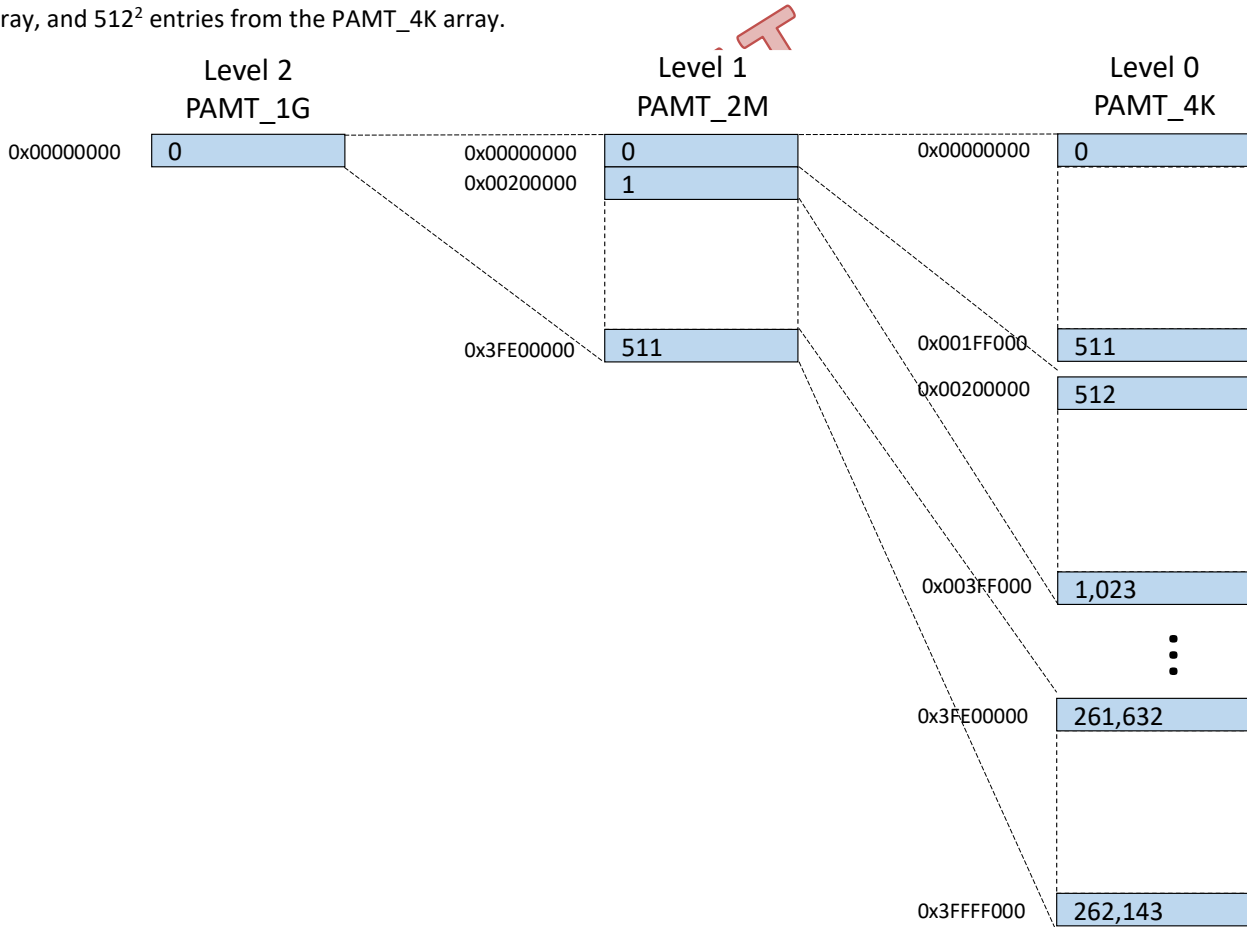

Figure 8.1: Typical Example of a PAMT Block Hierarchy for a 1GB TDMR Block

8.3.3. PAMT Page Types

Table 8.2 below describes the PAMT page types:

Table 8.2: PAMT Page Types

Page Type	PAMT Level	Associated TDX Page	Description
PT_NDA	Any	Depending on PT at higher PAMT level (if any)	The physical page is Not Directly Assigned to the Intel TDX module at this size (4K, 2M or 1G) and PAMT level. This page may be part of a larger page that is assigned to the Intel TDX module at a higher level, or this page may contain smaller pages that are assigned to the Intel TDX module at lower levels. See Table 8.3 below for details.
PT_RSVD	PAMT_4K	None	The physical page is reserved for non-TDX usage. The Intel TDX module will not allow converting this page to any other page type. The page can be used by the host VMM for any purpose. PT_RSVD is used for implementing reserved areas within TDMRs. See 4.1.3.2.1 for details.
PT_REG	Any	TD private page	The physical page at this PAMT level (4K, 2M or 1G) holds TD private memory and is mapped in the guest TD GPA space by the Secure EPT.
PT_TDR	PAMT_4K	TDR	TDR control structure page
PT_TDCX	PAMT_4K	TDCX	One 4KB physical page of a multi-page control structure
PT_TDVPR	PAMT_4K	TDVPR	Root page of the multi-page TDVPS control structure
PT_EPT	PAMT_4K	Secure EPT	Secure EPT page

5 8.3.4. PAMT Hierarchy

Table 8.3 below shows the page type (PT) of PAMT entries at the three levels of hierarchy, depending on whether the page is assigned to the Intel TDX module manages the page, whether the page is mapped in secure EPT, and the mapping size.

Table 8.3: PAMT Hierarchy and Page Types

Intel TDX Module Management			PAMT Entry Page Type		
Assigned to TDX?	Physical Page Size	GPA Mapping Size (Secure EPT Level)	PAMT_1G (Level 2)	PAMT_2M (Level 1)	PAMT_4K (Level 0)
No	4KB	N/A	PT_NDA	PT_NDA	PT_RSVD
No	4KB	N/A	PT_NDA	PT_NDA	PT_NDA
Yes	4KB	None	PT_NDA	PT_NDA	PT_TDR, PT_TDCX, PT_TDVPR, PT_EPT
Yes	4KB	4KB (Level 0)	PT_NDA	PT_NDA	PT_REG
Yes	2MB	2MB (Level 1)	PT_NDA	PT_REG	PT_NDA
Yes	1GB	1GB (Level 2)	PT_REG	PT_NDA	PT_NDA

10

Note the following:

- A 4KB page is considered **free** (i.e., not assigned to TDX) if its PAMT.PT at all three PAMT levels is PT_NDA. Any function that attempts to assigns an HPA to TDX (e.g., TDH.MEM.PAGE.ADD) is designed to check this.
- In all other cases, PAMT.PT is different than PT_NDA in only one of the three PAMT levels.

- When a page is mapped by Secure EPT at 4KB, 2MB or 1GB GPA mapping size, it is managed by the Intel TDX module as a physical page of the same size. Secure EPT is described in Chapter 9.
- PT_RSVD pages cannot be used by the Intel TDX module. They are used for implementing reserved areas within TDMRs. See 4.1.3.2.1 for details.

8.4. Adding Physical Pages

8.4.1. Preventing Cache Line Aliasing

Before adding a physical page, the host VMM is responsible for making sure no MODIFIED cache lines exist for that page. The host VMM can flush cache lines to memory – e.g., using CLFLUSH (only for pages containing data encrypted with a shared HKID – the VMM cannot directly use an HPA with a private HKID), or TDH.PHYMEM.PAGE.WBINVD (for pages containing data encrypted with any HKID, as long as the page is within a TDMR). Flushing cache lines to memory is required to avoid corruption due to cache line aliasing.

8.4.2. Adding Pages not Mapped to the Guest TD

By design, TD control structure pages TDR, TDCX and TDVPR are not mapped to the guest TD's GPA space, and they are only managed using their HPA. The functions TDH.MNG.CREATE, TDH.MNG.ADDCX, TDH.VP.CREATE and TDH.VP.ADDCX are designed to add 4KB control structure pages PT_TDR, PT_TDCX and PT_TDVPR, respectively. The overall process is described in 7.3 and 7.4.

8.4.3. Adding Pages and Mapping to the Guest TD's GPA

The following page types are associated with a guest TD's GPA:

- Guest TD private pages
- Secure EPT pages are mapped to the guest TD's GPA space.

Those pages are added given their HPA and the required GPA. The functions TDH.MEM.PAGE.ADD, TDH.MEM.PAGE.AUG, TDH.MEM.PAGE.RELOCATE and TDH.IMPORT.MEM add a PT_REG page, and the functions TDH.MEM.SEPT.ADD and TDH.MEM.PAGE.DEMOTE add a 4KB PT_EPT page. TD private memory management functions are described in Chapter 9. This section describes only their physical page management aspects.

8.5. Reclaiming Physical Pages

8.5.1. Required Cache Flush and Initialization by the Host VMM

Once a physical page is reclaimed from a TD, it should be free for use by the host VMM for any purpose, provided that the operations described below are done.

Cache Flush

To help avoid stability issues caused by cache line aliasing, the host VMM should also ensure that no cache lines associated with the removed page are in a Modified state, before the page is reused for any purpose.

- During the TD's lifetime, this can be done by calling TDH.PHYMEM.PAGE.WBINVD.
- If the TD has been torn down and is in the in TD_TEARDOWN state, cache has already been flushed by TDH.PHYSMEM.CACHE.WB as part of the teardown sequence, so no further operation is required – except for the TDR page as described below.

Page Initialization

Before the physical page is used for anything except TD private memory page or TDX control structure page, the host VMM should initialize it using MOVDIR64B. This helps ensure that no content encrypted with a private HKID remains for that physical page, which may result in an integrity violation or TD bit mismatch detection when later being read using a shared HKID. For details, see Ch. 16.

If the page is to be used as a new TD private memory page or TDX control structure page, this initialization is not required since the TDX module will initialize the page.

8.5.2. Reclaiming Pages not Mapped to the Guest TD

There are two cases where pages are not considered as mapped to the guest TD:

- Control structure pages are not mapped to the guest TD.
- In TD_TEARDOWN state, as described below, no mapping is in effect.

5 8.5.3. Reclaiming TD Pages in TD_TEARDOWN State

As part of the TD teardown process, the VMM needs to put the TD into a TD_TEARDOWN state, as described in 7.4. This is a non-recoverable state where TD keys have been reclaimed, all address translations and caches have been flushed, and the TD private memory and control structures (except TDR) are no longer accessible.

10 By design, in the TD_TEARDOWN state, all TD pages are effectively unmapped. Secure EPT is not accessible, and no GPA-to-HPA mapping can be used. The host VMM must treat all the TD private pages and control structure pages as physical memory and reclaim them using the TDH.PHYMEM.PAGE.RECLAIM function in any order, as long as the TDR page is the last one to be reclaimed.

15 For TDR page, the intention is for the host VMM to call TDH.PHYMEM.PAGE.WBINVD after calling TDH.PHYMEM.PAGE.RECLAIM. This is required to avoid corruption due to cache line aliasing because the TDR page has still been accessed and modified, even when the TD was in TD_TEARDOWN state.

8.5.4. Reclaiming Physical Pages as Part of TD Private Memory Management

20 Functions such as TDH.MEM.PAGE.REMOVE and TDH.MEM.PAGE.PROMOTE are designed to remove TD private pages and Secure EPT pages, respectively. By design, they first make sure the pages are no longer accessible using a GPA, then they mark the physical page as free. This is described in Chapter 9; this section only highlights the physical page reclamation.

DRAFT

9. TD Private Memory Management

This chapter described how the Intel TDX module helps manage TD private memory and guest-physical address (GPA) translation.

9.1. Overview

- 5 Intel TDX ISA introduced the concept of private GPA vs. shared GPA, depending on the GPA.SHARED bit. In SEAM non-root mode, the controlling VMCS has two EPT pointer fields:
- The legacy EPT pointer is used for translating the guest TD’s memory accesses using a private GPA (i.e., GPA.SHARED == 0).
 - A new Shared EPT pointer is used for translating the guest TD’s memory accesses using shared GPAs (i.e., GPA.SHARED == 1).
- 10

A new GPAW execution control determines the position of the SHARED bit in the GPA, and a new HKID execution control defines the HKID used for accessing TD private memory.

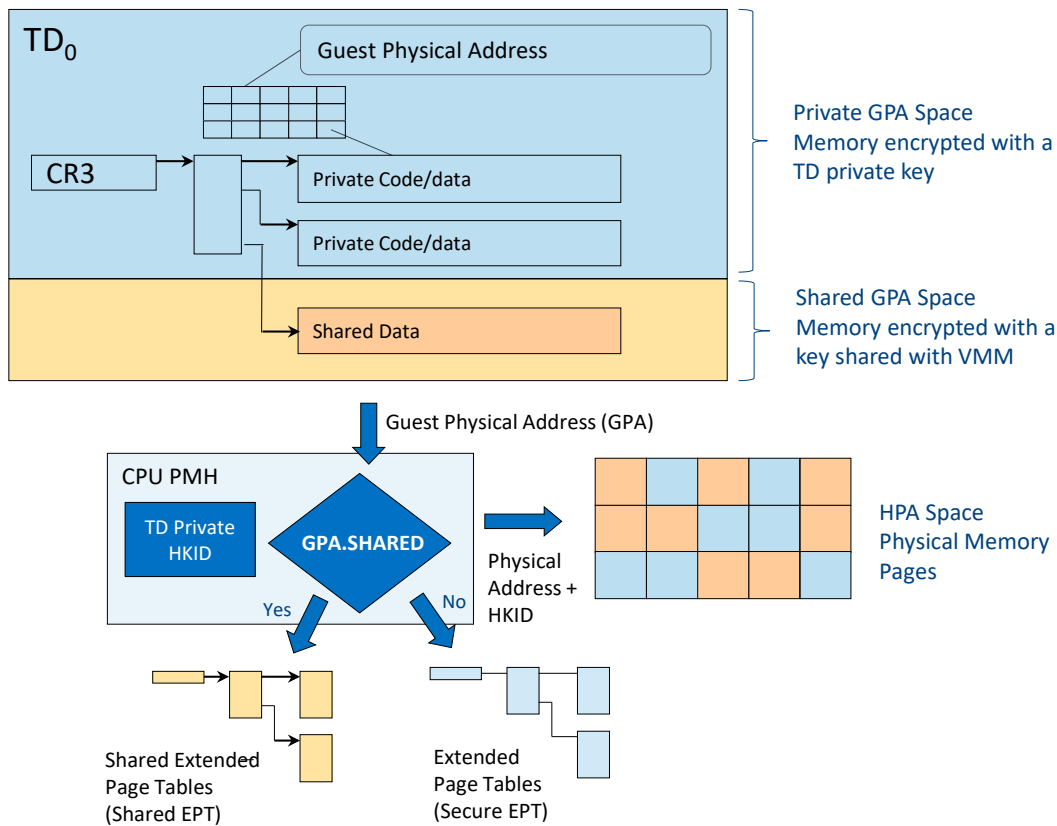

Figure 9.1: Secure EPT Concept

- 15 The Intel TDX module maintains a single Secure EPT structure per TD. Secure EPT pages are designed to be opaque; they reside in ordinary memory, and they are encrypted and integrity-protected with the TD’s ephemeral private key. The Intel TDX module does not map Secure EPT pages to the guest TD GPA space. Thus, Secure EPT is effectively not accessible by any software besides the Intel TDX module, nor by any devices. Any such access using shared HKID to Secure EPT can lead to data corruption that triggers integrity check failure leading to a machine check fault.
- 20 Secure EPT is intended to be managed indirectly by the host VMM using Intel TDX functions. The Intel TDX module helps ensure that the Secure EPT is managed correctly.

The CPU translates shared GPAs using the Shared EPT which resides in host VMM memory. The translation uses a shared HKID, and it is directly managed by the host VMM, just as with legacy VMX.

9.2. Secure EPT Entry

9.2.1. UPDATED: Overview

From the CPU perspective, Secure EPT has the same structure as a legacy VMX EPT.

For the purpose of private memory management, the Intel TDX module hold a state value in each Secure EPT entry. This state value is encoded by multiple bits.

Table 9.1: UPDATED: Secure EPT Entry State High Level Description

State Name	Description
FREE	Secure EPT entry does not map a GPA range.
REMOVED	Secure EPT entry is of a removed page
NL_MAPPED	Secure EPT entry maps a private GPA range which is accessible by the guest TD.
NL_BLOCKED	Secure EPT entry maps a private GPA range, but new address translations to that range are blocked.
MAPPED	Secure EPT entry maps a private GPA page which is accessible by the guest TD.
BLOCKED	Secure EPT entry maps a private GPA page but new address translations to that range are blocked.
BLOCKEDW	Secure EPT entry maps a private GPA page, but new address translations for write operations to that range are blocked.
EXPORTED_BLOCKEDW	Secure EPT maps a private page that has been blocked for writing and exported.
EXPORTED_DIRTY	Secure EPT entry maps a private page that was exported but is not blocked for writing and its content and/or attributes may have since been modified.
EXPORTED_DIRTY_BLOCKEDW	Secure EPT entry maps a private page that was previously exported, its content and/or attributes may have since been modified and then it was blocked for writing.
PENDING	Secure EPT entry maps a 4KB or a 2MB page that has been dynamically added to the guest TD using TDH.MEM.PAGE.AUG and is pending acceptance by the guest TD using TDG.MEM.PAGE.ACCEPT. This page is not yet accessible by the guest TD.
PENDING_BLOCKED	Secure EPT entry is both pending and blocked.
PENDING_BLOCKEDW	Secure EPT entry is both pending and blocked for writing.
PENDING_EXPORTED_BLOCKEDW	Secure EPT entry is both pending and exported.
PENDING_EXPORTED_DIRTY	Secure EPT entry is both pending and exported and is not blocked for writing.
PENDING_EXPORTED_DIRTY_BLOCKEDW	Secure EPT entry is both pending and exported and is blocked for writing.

Secure EPT entry is opaque; the host VMM may not access it directly. The host VMM may read a Secure EPT entry information using the TDH.MEM.SEPT.RD interface function. In addition, multiple other interface functions return the same information in case of an error that is related to a Secure EPT entry. For details, see the [TDX Module ABI Spec].

9.2.2. UPDATED: SEPT Entry State Diagrams

The figures below show partial state diagrams for the basic memory management operation for a leaf and a non-leaf SEPT entry.

Note: The diagrams below are partial. SEPT entry state diagrams for TD migration are provided in the [TD Migration Spec]. SEPT entry state diagrams for TD partitioning are provided in the [TD Partitioning Spec].

5

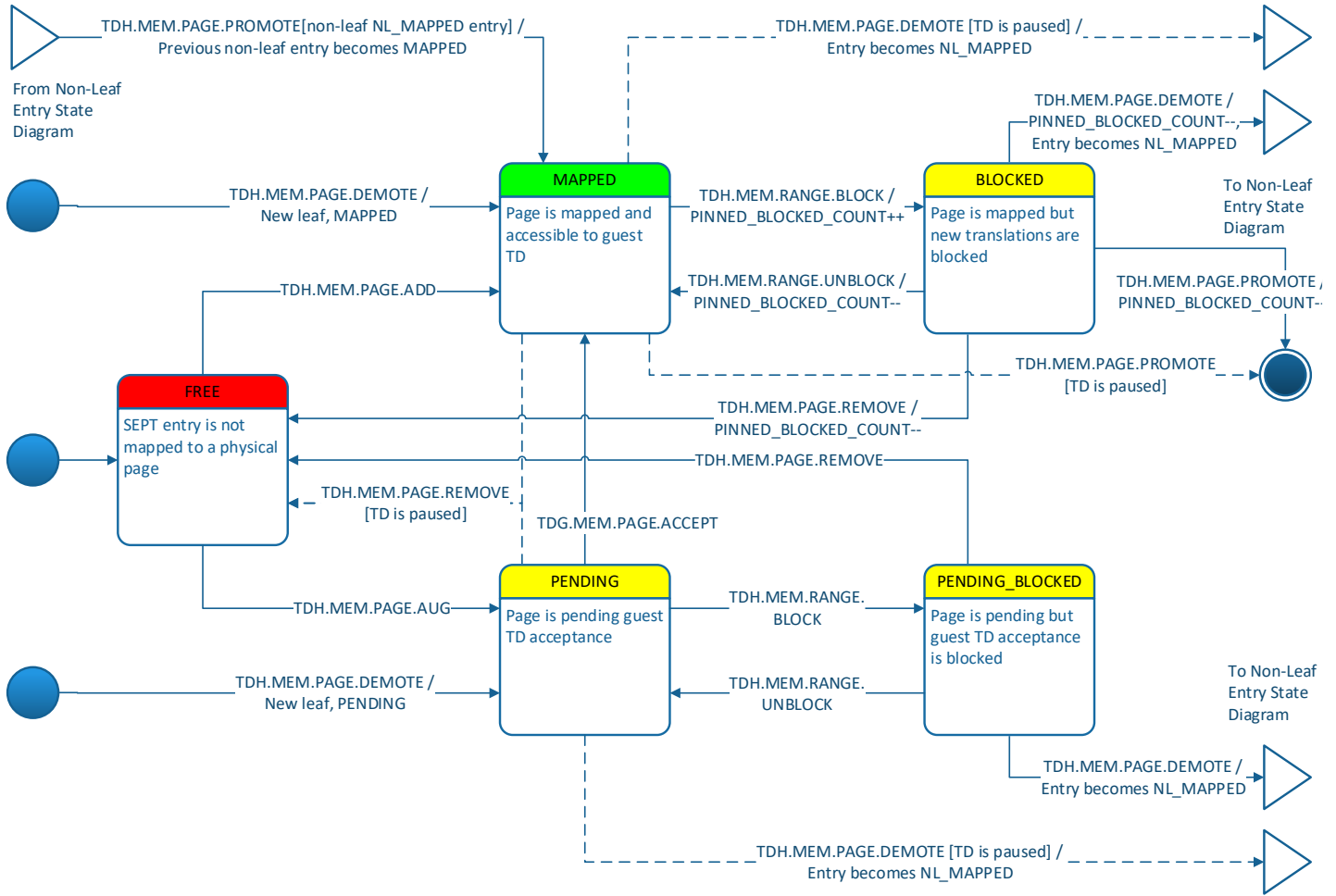

Figure 9.2: Secure EPT Leaf Entry Basic Operation Partial State Diagram

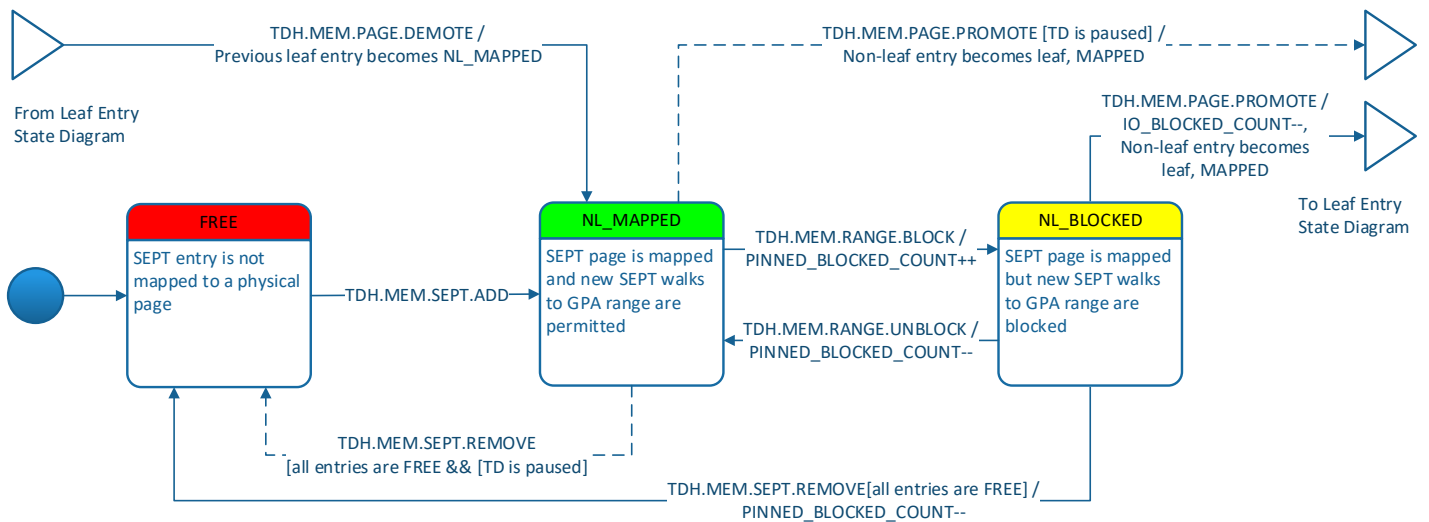

Figure 9.3: Secure EPT Non-Leaf Entry Basic Operation Partial State Diagram

10

9.3. Secure EPT Walk

Host-side (SEAMCALL) Intel TDX functions that manage TD private memory usually accept GPA and Level parameters. They perform a Secure EPT walk which locates the target Secure EPT entry.

If the Secure EPT walk is completed successfully, the Intel TDX function may operate on the located Secure EPT entry. Otherwise, the function typically returns the last visited EPT entry and its level to the host VMM.

Guest-side (TDCALL) Intel TDX functions typically perform an EPT walk similar to the EPT walk done by the CPU. Only the GPA is provided as an input, and the function may walk the Shared EPT or the Secure EPT, depending on the specific function and the GPA's SHARED bit.

9.4. **UPDATED:** Secure EPT Induced TD Exits

Intel SDM, Vol. 3, 26.2.1 Basic VM-Exit Information

Guest TD memory access to a non-present private GPA causes an asynchronous TD exit with an EPT Violation exit reason. As discussed in 9.2 above, a non-present GPA is any private GPA for which there is either no Secure EPT entry, or the Secure EPT entry is not in the MAPPED state.

Secure EPT-induced TD exits may also be triggered during a guest-side local flow, performing some function on behalf of the guest TD, and executed by the Intel TDX module.

On EPT violation TD exit, VM exit information is provided to the host VMM. This helps the VMM analyze the reason for the EPT violation and take proper action.

Table 9.2: EPT Violation TD Exit Cases and Possible Host VMM Actions

Reason	May be Indicated by	Possible Host VMM Action
Page is not mapped to the TD GPA space	<ul style="list-style-type: none"> Exit qualification bits 6:3 are 0. The host VMM knows, based on its internal data, that either the page or a Secure EPT page that maps it has not been allocated to the TD. 	The host VMM may use this as a trigger for dynamic memory allocation (TDH.MEM.PAGE.AUG) or for a post-copy migration import (see [TD Migration Spec]).
Page is BLOCKED or GPA range is NL_BLOCKED	<ul style="list-style-type: none"> Exit qualification bits 6:3 are 0. The host VMM knows, based on its internal data, that the page or a Secure EPT page that maps it has been blocked. 	The host VMM may resume the TD (TDH.VP.ENTER), possibly after taking some action (e.g., TDH.MEM.PAGE.PROMOTE) for which the page has been blocked.
Page is PENDING or PENDING_EXPORTED_DIRTY	<ul style="list-style-type: none"> Exit qualification bits 6:3 are 0. The host VMM knows, based on its internal data, that the page has been assigned to the TD using TDH.MEM.PAGE.AUG. 	This happens only if the TD's ATTRIBUTES.SEPT_VE_DISABLE is set to 1. The VMM may resume the TD.
Page is blocked for writing (*BLOCKEDW)	<ul style="list-style-type: none"> Exit qualification bit 1 is 1, indicating a write access, and bit 4 is 0, indicating write blocking. The host VMM knows, based on its internal data, that the page has been blocked for writing using TDH.EXPORT.BLOCKW 	The host VMM may unblock the page (TDH.EXPORT.UNBLOCKW). for details, see [TD Migration Spec].

By design, since secure EPT is fully controlled by the TDX module, an EPT misconfiguration on a private GPA indicates a TDX module bug and is handled as a fatal error.

9.5. **UPDATED:** Secure EPT Induced Exceptions

If the TD's ATTRIBUTES.SEPT_VE_DISABLE is 0, guest TD memory access to a private GPA for which the Secure EPT entry state is PENDING or PENDING_EXPORTED_DIRTY causes a #VE.

Guest TD memory access, with any GPA bit at position higher than the SHARED bit but lower than MAXPA set to 1, causes a #PF exception. See 11.11.1.

9.6. **UPDATED:** Secure EPT Concurrency

Secure EPT concurrency rules are designed to allow concurrent operations on multiple Secure EPT entries. Secure EPT concurrency is controlled by the following mechanisms:

- An exclusive/shared lock on the whole Secure EPT tree.
- A mutex on each Secure EPT entry, controlling host-side (SEAMCALL) access.
- A mutex on each Secure EPT entry, controlling guest-side (TDCALL) access.

Host-Side (SEAMCALL) Interface Functions

- TDX module interface functions that use GPA as an input acquire a **shared lock on the whole Secure EPT tree** of the target TD to help prevent changes to the tree while they execute.
- Most interface functions that use GPA as an input acquire an **exclusive host-side lock on the Secure EPT entry or entries** which they use. An exception to this is TDH.MEM.SEPT.RD, which just reads a Secure EPT entry and does not use it to actually access memory.
- In specific cases where a Secure EPT entry update may collide with a concurrent update done by the guest TD, host-side interface functions update the Secure EPT entry as a transaction, using atomic compare and exchange operation.
- Host-side interface functions that obtain exclusive access to the whole Secure EPT tree, such as TDH.MEM.SEPT.REMOVE, are considered as implicitly having exclusive access to each of its entries.
- Host-side interface functions that obtain exclusive access to the TDR page (and thus, to the whole TD), such as TDH.MEM.PAGE.ADD, are considered as implicitly having exclusive access to the Secure EPT tree and each of its entries.

Guest-Side (TDCALL) Interface Functions

Guest-side TDX module interface functions that need to translate a GPA to an HPA emulate the CPU's top-down EPT walk operation.

- Guest-side interface functions have no concurrency restrictions on the whole Secure EPT tree.
- Guest-side interface functions that need to update a Secure EPT entry (currently, only TDG.MEM.PAGE.ACCEPT) acquire an **exclusive guest-side lock** on that entry. This lock is only checked by other similar guest-side functions, but not by host-side functions. Thus, Secure EPT entry update is done as a transaction, using atomic compare and exchange operation.

9.7. Introduction to TLB Tracking

The goal of TLB tracking is to be able to prove (when needed) that no logical processor holds any cached Secure EPT address translations to a given TD private **GPA range**. TLB tracking is required when removing a mapped TD private page (TDH.MEM.PAGE.REMOVE) or when changing the page mapping size (TDH.MEM.PAGE.PROMOTE), etc.

Cached address translations include implicit address translations (TLB) and paging structure translations (PxE) held by the CPU. In addition, GPAs that are translated by the TDX module to HPA and written to VMX control structure fields, to be read by the CPU, are also considered cached address translation.

New: Conditions when TLB Tracking is not Required

TLB tracking is not required when the TD's OP_STATE implies that no TD VCPU may run at the time GPA mapping operation modification (e.g., TDH.MEM.PAGE.REMOVE) is done. The only OP_STATE values when TD VCPU may run are the following:

- RUNNABLE
- LIVE_EXPORT
- LIVE_IMPORT

In addition, TLB tracking is not required if the GPA range's Secure EPT entry state implies that no cached address translations may exist for that Secure EPT entry. This applies to the following SEPT entry states (see the [TDX Module ABI Spec] for details):

- EXPORTED_BLOCKEDW, PENDING_EXPORTED_BLOCKEDW: The page has been exported by TDH.EXPORT.MEM and it is blocked for writing.
- FREE, REMOVED: The page has been removed (e.g., by TDH.MEM.PAGE.REMOVE).

GPA Range TLB Tracking Sequence

This sequence is intended to be used by the host VMM to help guarantee no EPT TLB entries exist to a set of GPA ranges.

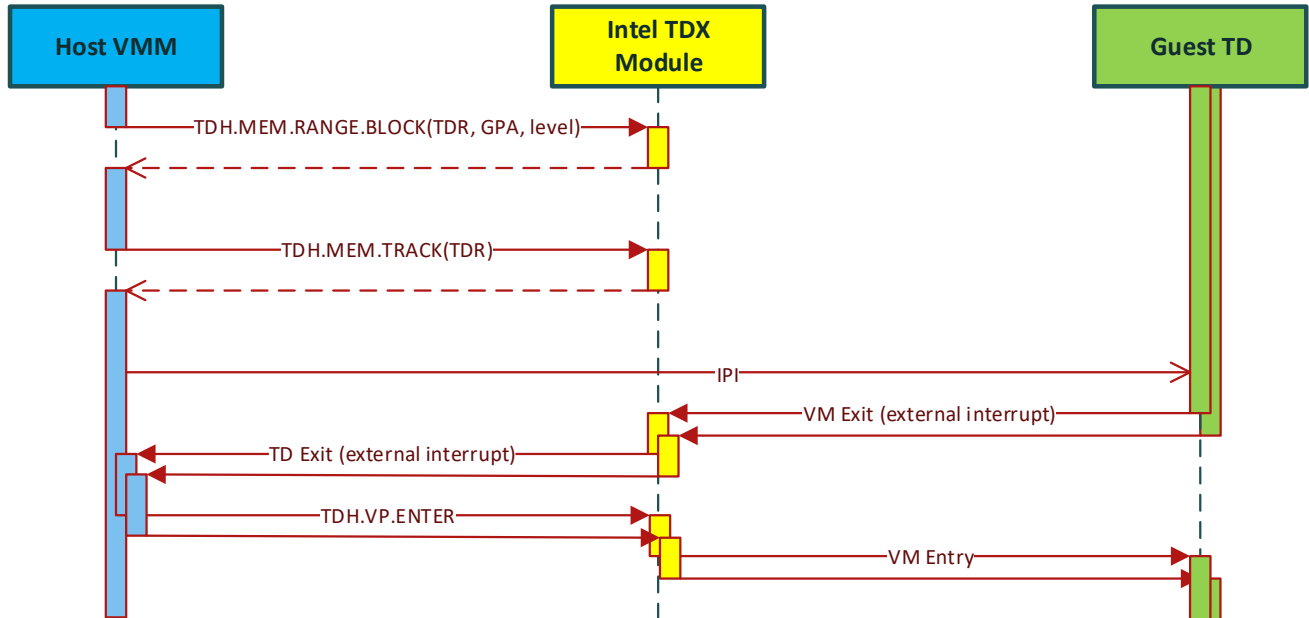

Figure 9.4: Typical TLB Tracking Sequence

The sequence typically includes five steps:

1. Execute `TDH.MEM.RANGE.BLOCK` on each GPA range, blocking subsequent creation of TLB translation to that range. Note that cached translations may still exist at this stage.
2. Execute `TDH.MEM.TRACK`, advancing the TD's epoch counter.
3. Send an Inter-Processor Interrupt (IPI) to each Remote Logical Processor (RLP) on which any of the TD's VCPUs is currently scheduled.
4. Upon receiving the IPI, each RLP will TD exit to the host VMM.

When each of the TD VCPUs has been inactive at least once following `TDH.MEM.TRACK`, the target GPA ranges are considered tracked. Even though some LPs may still hold TLB entries to the target GPA ranges, the following TD entry to each of the TD VCPUs is designed to flush them.

Note: If the host VMM counts the number of active VCPUs, and following `TDH.MEM.TRACK` this number is 0, the host VMM may skip the IPIs – all VCPUs are already considered tracked.

5. Normally, the host VMM on each RLP will treat the TD exit as spurious and will immediately re-enter the TD.

9.8. Secure EPT Build and Update: `TDH.MEM.SEPT.ADD`

The host VMM can use the `TDH.MEM.SEPT.ADD` function to add a Secure EPT page to a guest TD. `TDH.MEM.SEPT.ADD` inputs are:

- Target TD, identified by its TDR HPA
- Destination physical page for the new Secure EPT table
- Mapping information: GPA and EPT level

At a high level, `TDH.MEM.SEPT.ADD` works as follows:

1. Check the TD keys are configured.
2. Check the destination physical page is marked as free in the PAMT.

3. Perform a Secure EPT walk to locate the Secure EPT non-leaf entry which will become the parent entry that maps the new Secure EPT page. To help prevent re-maps, TDH.MEM.SEPT.ADD checks the mapping does not already exist, else it aborts the operation.
4. Initialize the target page to zero using the target TD's private HKID and direct writes (MOVDIR64B).
5. Update the parent Secure EPT entry to map the page as MAPPED.
6. Update the page's PAMT entry with the PT_EPT page type and the TDR PA as the OWNER.

The Secure EPT's root page (EPML4 or EPML5, depending on whether the host VMM uses 4-level or 5-level EPT) does not need to be explicitly added. It is created during TD initialization (TDH.MNG.INIT) and is stored as part of TDCS. On each VCPU initialization, TDH.VP.INIT copies the address of the Secure EPT root page to the VCPU's TD VMCS's EPTP field clearing the HKID bits to 0⁵.

The following example illustrates the build process of a 4-level Secure EPT hierarchy:

1. The host VMM calls TDH.MNG.CREATE(TDR_PA = TDR₀) to create the TD.
2. The host VMM calls TDH.MNG.ADDCX(TDR_PA = TDR₀, DST_PA = TDCX_PAGE_PA) multiple times to allocate pages for TDCS. One of those pages will be used to host the Secure EPT root page D₀.
3. Host VMM calls TDH.MNG.INIT(TDR_PA = TDR₀) to initialize the TD and set an EPML4 page in one of the previously added TDCX pages as the Secure EPT root page. This updates TDCS.EPTP.
4. TDH.VP.INIT of each VPCU copies TDCS.EPTP to the TD VMCS's EPTP field.
5. Host VMM calls TDH.MEM.SEPT.ADD(TDR_PA = TDR₀, DST_PA = D₁, GPA = G₀, LVL= 3) to add an EPDPT page.
6. Host VMM calls TDH.MEM.SEPT.ADD(TDR_PA = TDR₀, DST_PA = D₂, GPA = G₀, LVL= 2) to add an EPD page.
7. Host VMM calls TDH.MEM.SEPT.ADD(TDR_PA = TDR₀, DST_PA = D₃, GPA = G₀, LVL= 1) to add an EPT page.

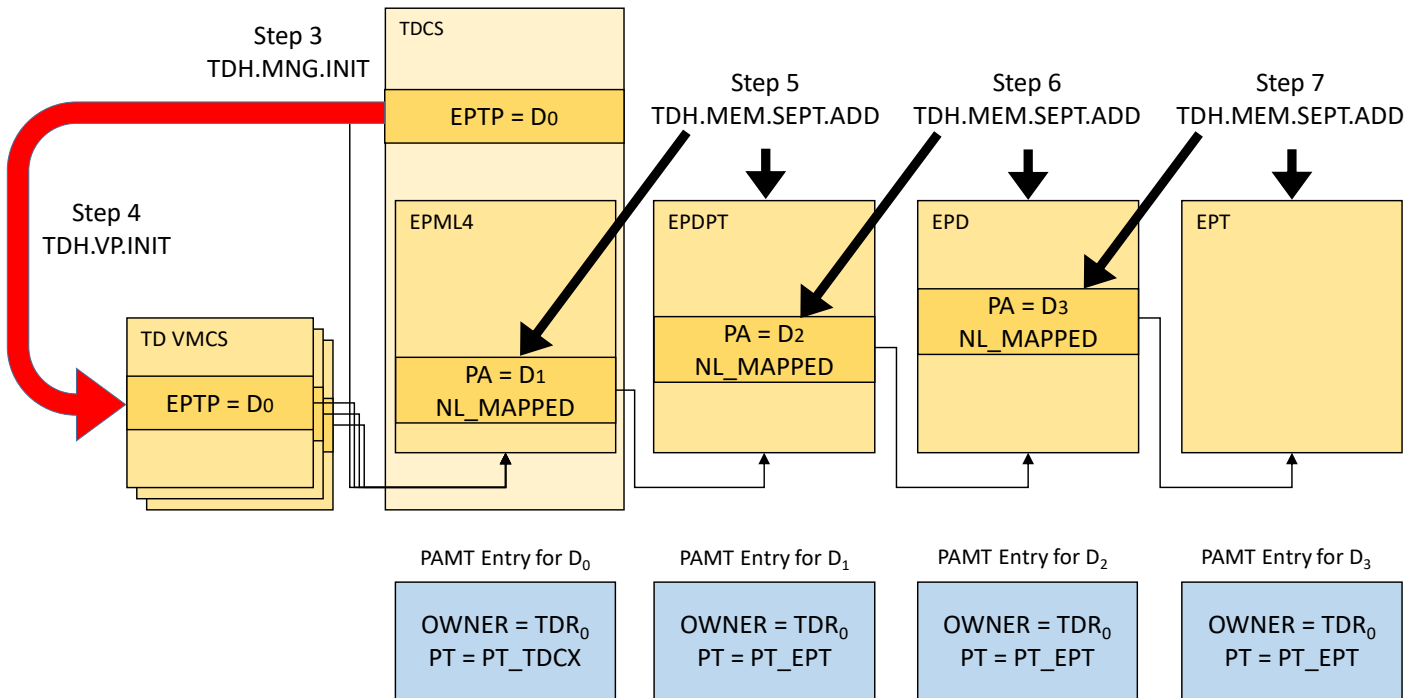

Figure 9.5: Typical Secure EPT Hierarchy Build Process

To help avoid stability issues caused by cache line aliasing, the VMM should ensure that no cache lines associated with the added physical SEPT page are in a Modified state, before calling TDH.MEM.PAGE.AUG. This is typically done by calling TDH.PHYMEM.PAGE.WBINVD.

9.9. Adding TD Private Pages during TD Build Time: TDH.MEM.PAGE.ADD

Adding TD private pages with arbitrary content is allowed only during TD build time (before TDH.MR.FINALIZE). The host VMM adds and maps 4KB private pages to a guest TD using TDH.MEM.PAGE.ADD with the following inputs:

- Target TD, identified by its TDR physical address

⁵ The CPU adds the TD's private HKID on EPT walks. Having HKID as 0 allows the host VMM to use INVEPT, for managing the usage of shared EPT which shares the ASID with the TD's secure EPT (see [9]).

- Source page physical address
- Destination page physical address
- Destination page GPA

At a high level, TDH.MEM.PAGE.ADD works as follows:

1. Check the TD has not been initialized.
2. Check the TD keys are configured.
3. Check the destination physical page is marked as free in the PAMT.
4. Perform a Secure EPT walk to locate the parent Secure EPT leaf entry that is going to map the new TD private page. To help prevent re-maps, TDH.MEM.PAGE.ADD checks the mapping does not already exist, else it aborts the operation.
5. Copy the source page to the destination page using the target TD's private HKID and direct writes (MOVDIR64B).
6. Update the previously located parent Secure EPT leaf entry to map the page as MAPPED.
7. Update the TD measurement with the new page GPA (as described in 12.1.1).
8. Update the PAMT entry with the PT_REG page type and the TDR PA as the OWNER.

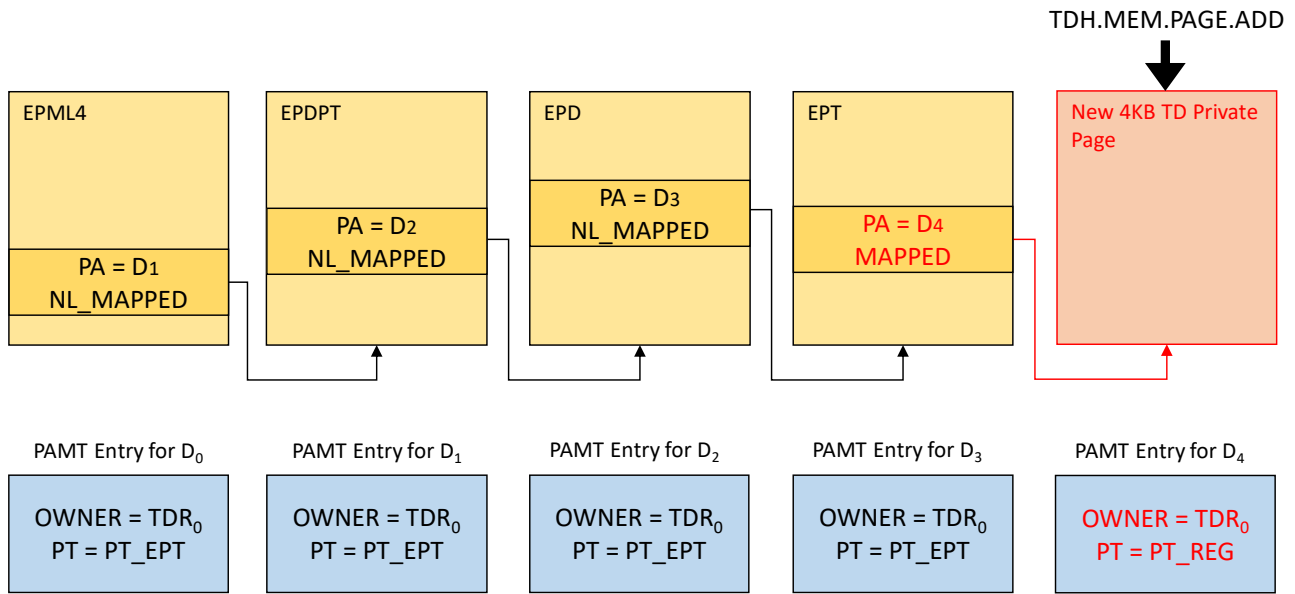

Figure 9.6: Typical Sequence for Adding a TD Private Page during TD Build Time

To help avoid stability issues caused by cache line aliasing, the VMM should ensure that no cache lines associated with the added physical page are in a Modified state, before calling TDH.MEM.PAGE.ADD. This is typically done by calling TDH.PHYMEM.PAGE.WBINVD.

9.10. Dynamically Adding TD Private Pages

9.10.1. Overview

Dynamically adding TD private pages after the guest TD has been initialized is typically done as a three-step process:

- The host VMM can update Secure EPT using TDH.MEM.SEPT.ADD and TDH.MEM.SEPT.REMOVE.
- The host VMM adds and maps a 4KB or a 2MB TD private page using TDH.MEM.PAGE.AUG. This page is not measured. The Secure EPT entry state for that added page is PENDING.
- The guest TD must accept the page before it can access it, using TDG.MEM.PAGE.ACCEPT. The page content is zeroed out.

This process is designed to help prevent attacks where the host VMM could remove arbitrary pages from the guest TD's GPA space (using TDH.MEM.PAGE.REMOVE) and replace them with zeroed-out pages.

A guest TD attempt to access a page that has been dynamically added by TDH.MEM.PAGE.AUG but has not yet been accepted by TDH.MEM.PAGE.ACCEPT results in a #VE exception.

Refer also to the software flow described in 3.3.1.1.

9.10.2. Page Addition by the Host VMM: TDH.MEM.PAGE.AUG

The host VMM can add and map 4KB and 2MB private pages to a guest TD in a non-present and pending state using TDH.MEM.PAGE.AUG, with the following inputs:

- Target TD, identified by its TDR physical address
- Destination page physical address
- Destination page GPA

At a high level, TDH.MEM.PAGE.AUG works as follows:

1. Check the TD keys are configured.
2. Check that the TD has either been initialized (by TDH.MNG.INIT) and no migration session is in progress, or that migration is in progress, but the TD is runnable (live export or import).
3. Check the destination physical page is marked as free in the PAMT.
4. Perform a Secure EPT walk to locate the parent Secure EPT leaf entry that is going to map the new TD private page. To help prevent re-maps, TDH.MEM.PAGE.AUG checks the mapping does not already exist, else it aborts the operation.
5. Update the previously located parent Secure EPT leaf entry to map the page as PENDING.
6. Update the PAMT entry with the PT_REG page type and the TDR PA as the OWNER.

Note that TDH.MEM.PAGE.AUG does not need to access the destination page itself; the page is initialized later on by TDG.MEM.PAGE.ACCEPT.

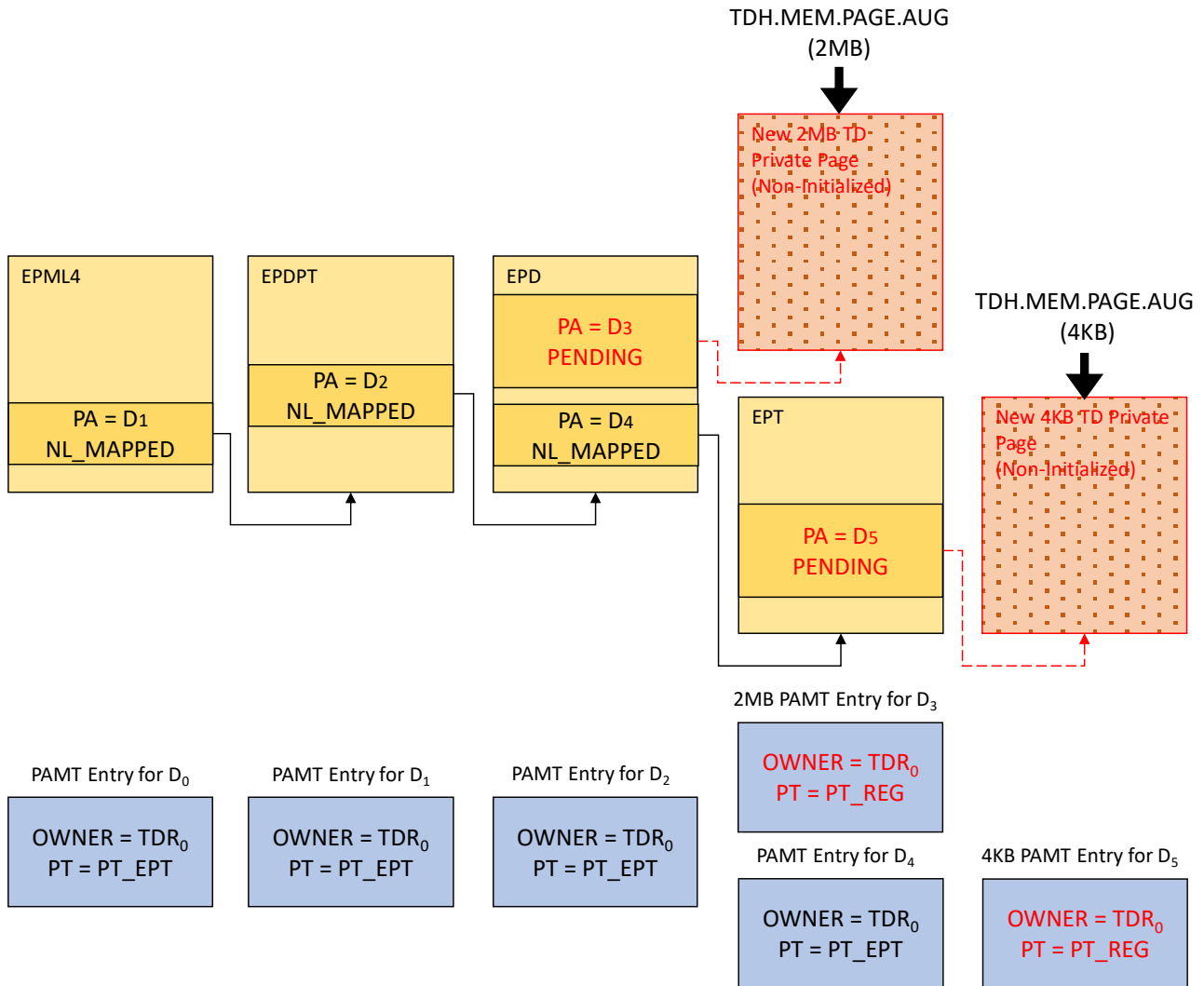

Figure 9.7: Host VMM Adding a 4KB or a 2MB TD Private Page

To help avoid stability issues caused by cache line aliasing, the VMM should ensure that no cache lines associated with the added physical page are in a Modified state, before calling TDH.MEM.PAGE.AUG. This can be done by calling TDH.PHYMEM.PAGE.WBINVD.

9.10.3. Page Acceptance by the Guest TD: TDG.MEM.PAGE.ACCEPT

9.10.3.1. Description

The guest TD can accept a dynamically added 4KB or 2MB page using TDG.MEM.PAGE.ACCEPT with the page GPA and size inputs.

5 At a high level, TDG.MEM.PAGE.ACCEPT works as follows:

1. Perform a Secure EPT walk to locate the parent Secure EPT leaf entry that maps the TD private page, and handle the walk results as described in the table below.

Table 9.3: TDG.MEM.PAGE.ACCEPT SEPT Walk Cases

SEPT Walk Terminal Entry			TDG.MEM.PAGE.ACCEPT Operation	Typical Software Handling
Level	Leaf or Non-Leaf	State		
Higher than requested	Leaf	Guest-accessible, i.e., MAPPED or EXPORTED_DIRTY (e.g., 2MB PTE present for a 4KB request).	Return a status code indicating a success, with a warning that the page is already present and mapped at a level higher than requested.	Option 1: This is OK, the host VMM did not use the memory released by the TD. Option 2: This is a guest bug; the status code helps debugging it.
		Not guest-accessible and not FREE (e.g., 2MB PTE pending for a 4KB request).	TD exit with EPT violation indicating the error SEPT entry level and state, and the guest-requested accept level. See the [TDX Module ABI Spec].	The host VMM demotes the page to match the requested accept size, It then re-enters the guest TD. TDG.MEM.PAGE.ACCEPT is re-invoked.
	Non-Leaf	Not guest-accessible (e.g., blocked PDE for a 4KB request).	TD exit with EPT violation indicating the error SEPT entry level and state, and the guest-requested accept level. See the [TDX Module ABI Spec].	This may be used as a guest TD request from the host VMM to add a page. The host VMM adds SEPT pages (TDH.MEM.SEPT.ADD) and the requested page (TDH.MEM.PAGE.AUG). It then resumes the guest.
Same as requested	Non-Leaf	Other than FREE (e.g., requested 2MB entry is mapped to a EPT page instead of being a leaf)	Return a status code indicating a size mismatch error.	The guest falls back to accept the range using 4K size.
	Leaf	Guest-accessible, i.e., MAPPED or EXPORTED_DIRTY	Return a status code indicating a success, with a warning that the page is already present.	Option 1: This is OK, the host VMM did not use the memory released by the TD. Option 2: This is a guest bug; the status code helps debugging it.
		Not PENDING nor PENDING_EXPORTED_DIRTY	TD exit with EPT violation indicating the error SEPT entry level and state, and the guest-requested accept level. See the [TDX Module ABI Spec].	The host VMM resolves the blocking (e.g., completes the memory management operation that required blocking) and resumes the guest.
		FREE	TD exit with EPT violation indicating the error SEPT entry level and state, and the guest-requested accept level. See the [TDX Module ABI Spec].	This may be used as a guest TD request from the host VMM to add a page. The hosts VMM adds the requested page (TDH.MEM.PAGE.AUG) and resumes the guest.

SEPT Walk Terminal Entry			TDG.MEM.PAGE.ACCEPT Operation	Typical Software Handling
Level	Leaf or Non-Leaf	State		
		PENDING	Complete the operation as described below.	Success

If passed:

Note: Since initializing a 2MB page may take a long time, TDG.MEM.PAGE.ACCEPT is interruptible and resumable.

2. If all the above checks pass, loop until done or interrupted:
 - 2.1. Initialize the next 4KB chunk of the page to zero using the target TD's private HKID and direct writes (MOVDIR64B).
 - 2.2. If the whole page has been initialized, update the parent Secure EPT entry to set its state to SEPT_PRESENT.
 - 2.3. Else, if there is a pending interrupt, resume the guest TD without updating RIP and any GPR. The CPU may handle the interrupt, causing a TD exit. When the TD is resumed, TDH.MEM.PAGE.ACCEPT will re-invoked.

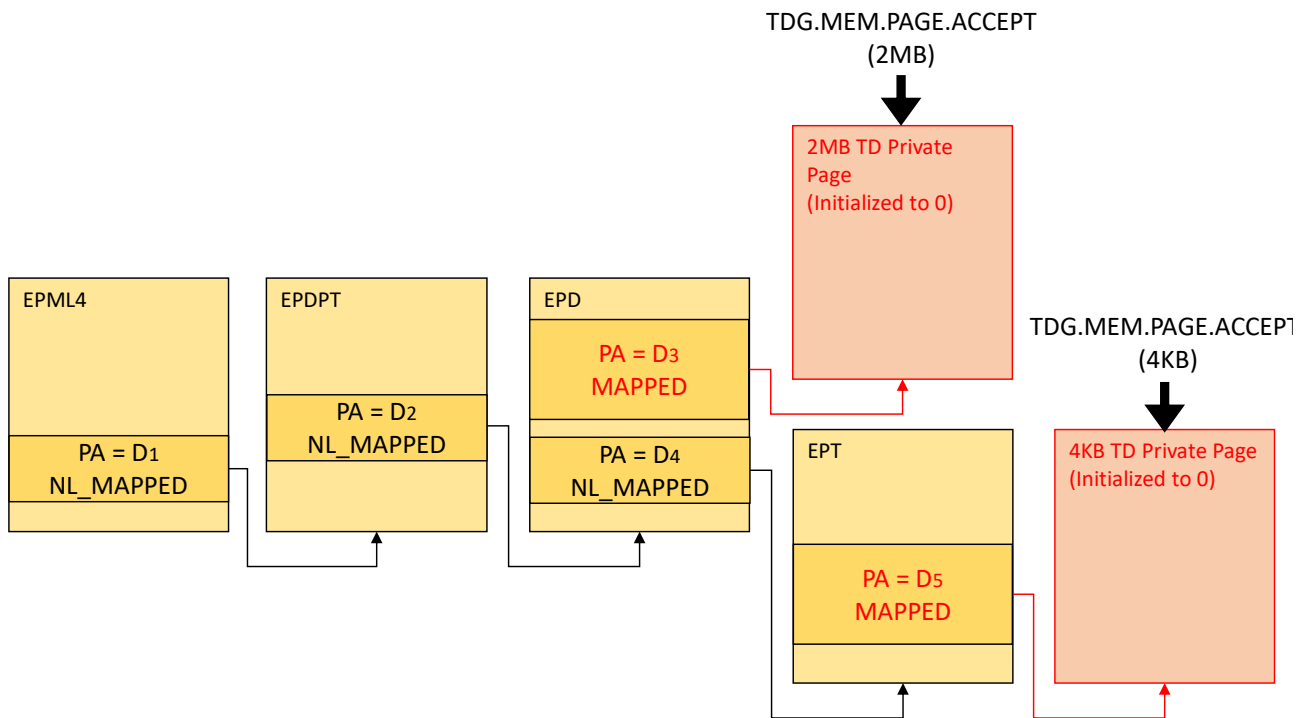

Figure 9.8: Guest TD Accepting a 4KB or 2MB Pending TD Private Page

9.10.3.2. TDG.MEM.PAGE.ACCEPT Concurrency

Guest-Side

TDG.MEM.PAGE.ACCEPT prevents the guest TD from concurrently accepting the same page by multiple threads. TDG.MEM.PAGE.ACCEPT may also encounter a concurrent host-side operation, such as TDH.MEM.RANGE.BLOCK, that attempts to update the same Secure EPT entry. In such cases, an error is returned to the guest TD, indicating that the Secure EPT entry is busy.

Host-Side

TDG.MEM.PAGE.ACCEPT does not prevent host-side operation, such as TDH.MEM.RANGE.BLOCK, from concurrently modifying the Secure EPT entry. TDG.MEM.PAGE.ACCEPT updates the entry using a locked compare and exchange operation. If the update failed, a TD Exit is caused, with an EPT Violation exit reason and an indication that the violation is due to TDG.MEM.PAGE.ACCEPT. For details, see the TDH.VP.ENTER definition in the [TDX Module ABI Spec].

9.11. Page Merge: TDH.MEM.PAGE.PROMOTE

The host VMM can merge the mapping of 512 consecutive 4KB or 2MB pages to a single 2MB or 1GB page, respectively. To do that, the host VMM should first perform the TLB tracking protocol on the large (2MB or 1GB) GPA range.

The host VMM should first call TDH.MEM.RANGE.BLOCK which operates on the EPT page for the large range (EPT for 2MB, EPD for 1GB). TDH.MEM.RANGE.BLOCK marks the parent EPT entry for that EPT page as **BLOCKED** and records the TD epoch in the PAMT entry of the EPT page. Figure 9.9 below shows the situation after TDH.MEM.RANGE.BLOCK blocked a 2MB GPA range.

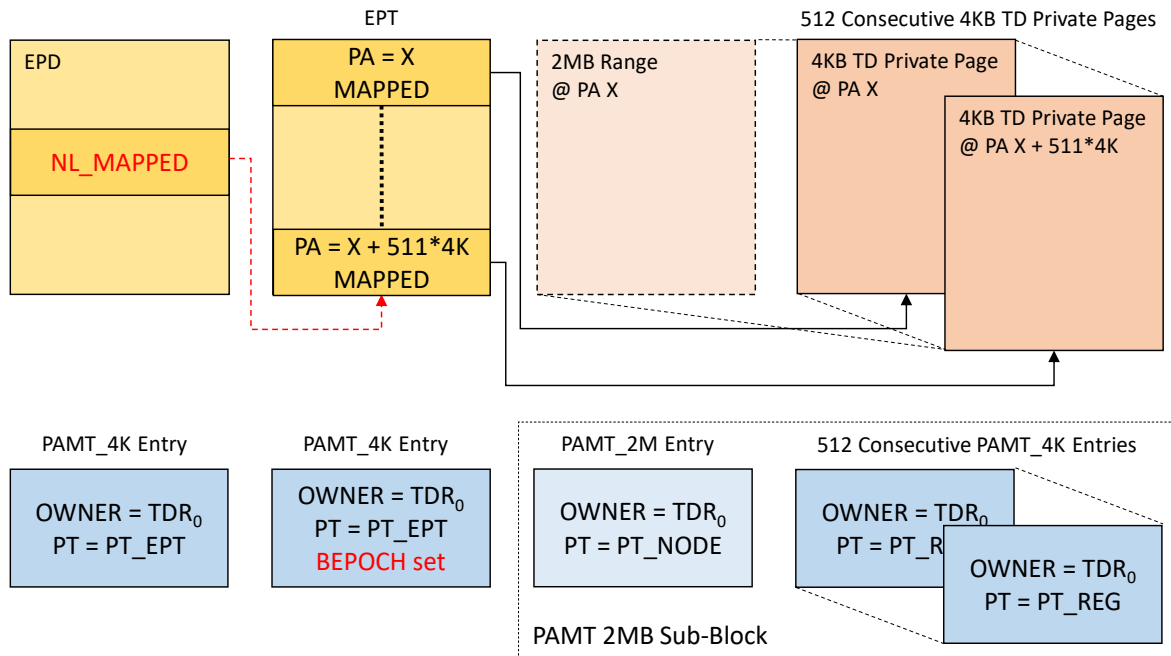

Figure 9.9: Typical State after Blocking a Range of 512 Consecutive 4KB TD Private Pages

Typically, the host VMM then calls TDH.MEM.TRACK and performs a round of IPIs. After that, there should be no active address translation to the large (2MB or 1GB) GPA range.

The actual merge is done by TDH.MEM.PAGE.PROMOTE which has the following inputs:

- The large range GPA
- The large page level (2MB or 1GB)

At a high level, TDH.MEM.PAGE.PROMOTE works as follows:

1. Check the TLB tracking condition for the large range GPA (i.e., the EPT or EPD page for that range).
2. Check that all 512 entries of that EPT or EPD page are in the MAPPED state and point to leaf pages whose physical address is contiguous within the same 2MB or 1GB range.

If all checks pass, TDH.MEM.PAGE.PROMOTE does the following:

1. Mark all the PAMT_4K or PAMT_2M entries of the small leaf pages (4KB or 2MB, respectively) as PT_NDA.
2. Mark the PAMT_2M or PAMT_1G entry of the merged large (2MB or 1GB, respectively) pages as PT_REG.
3. Set the parent EPT entry to point to the merged large page and mark it as present.
4. Mark the original EPT or EPD page's PAMT entry as PT_NDA, effectively removing this for any use by the host VMM.

The host VMM should flush the former EPT or EPD physical page's cache lines and initialize its content before it is reused, as described in 8.5.1.

Figure 9.10 below shows a typical 2MB merged page after TDH.MEM.PAGE.PROMOTE.

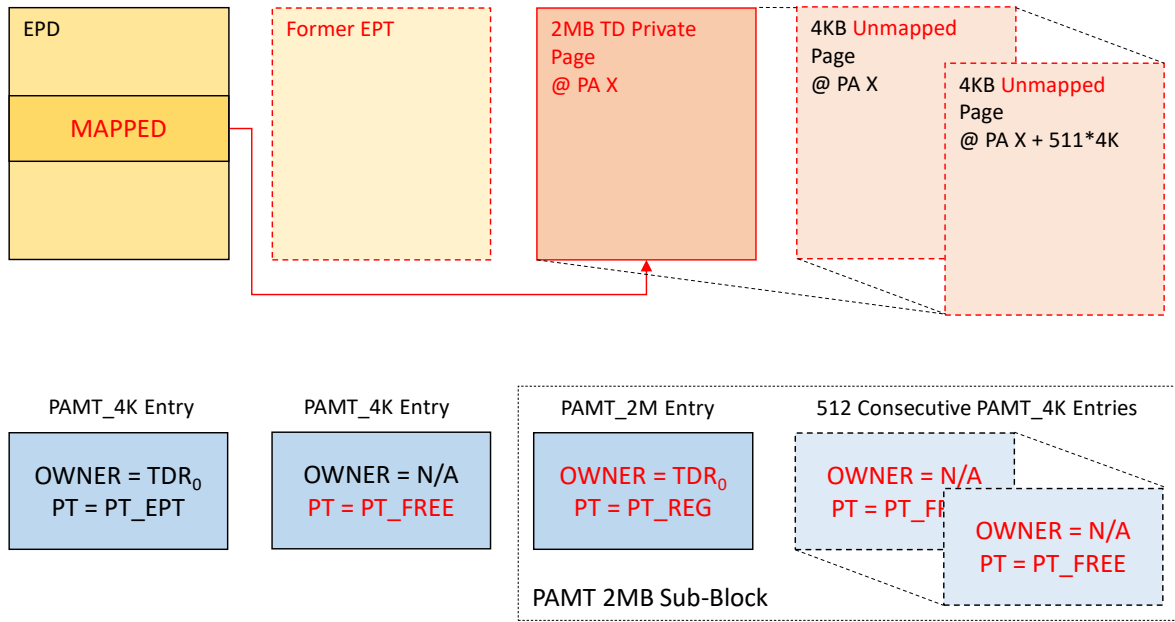

Figure 9.10: Typical State of a 2MB TD Private Page after TDH.MEM.PAGE.PROMOTE

Refer also to the software flow described in 3.3.1.3.

9.12. Page Split: TDH.MEM.PAGE.DEMOTE

- 5 The host VMM can split the mapping of a single 2MB or 1GB page to 512 consecutive 4KB or 2MB pages, respectively. To do that, the host VMM should first perform the TLB tracking protocol on the large (2MB or 1GB) page.

The host VMM should first call TDH.MEM.RANGE.BLOCK on the large page. TDH.MEM.RANGE.BLOCK marks the parent EPT entry for that page as **BLOCKED** and records the TD epoch in the PAMT entry of the page. Figure 9.11 below shows the typical situation after TDH.MEM.RANGE.BLOCK blocked a 1GB large page.

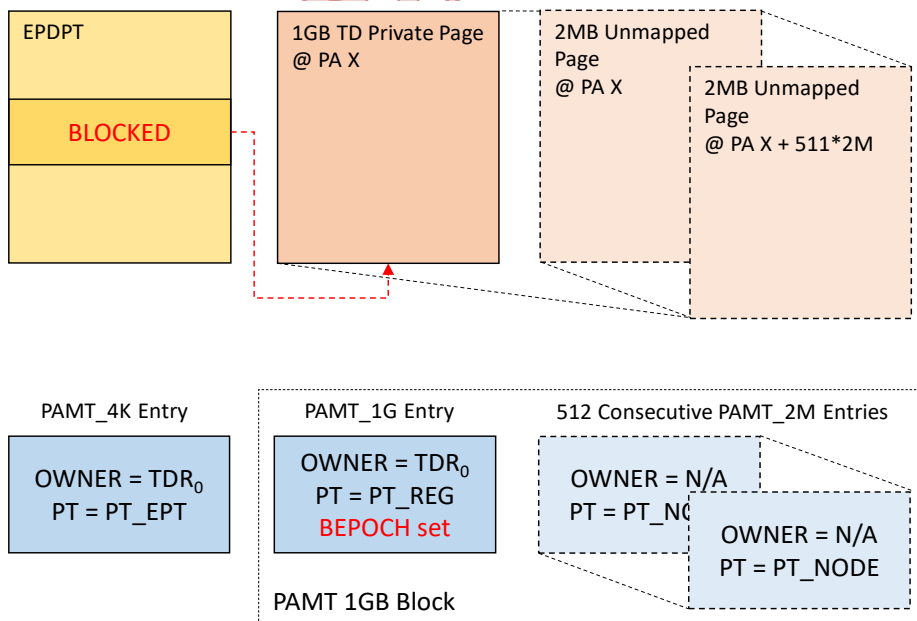

Figure 9.11: Typical State after Blocking a 1GB Page

Typically, the host VMM then calls TDH.MEM.TRACK and performs a round of IPIs. After that, there should be no active address translation to the large (2MB or 1GB) page.

The actual split is done by TDH.MEM.PAGE.DEMOTE which has the following inputs:

- 15 • The large page GPA
- The large page level (2MB or 1GB)

- The physical address of a free page that will be used for a new EPT or EPD page

At a high level, TDH.MEM.PAGE.DEMOTE works as follows:

1. Check the TLB tracking condition for the large page.
 2. Check that the physical page for the new EPT or EPD is marked as free in the PAMT.
- 5 If all checks pass, TDH.MEM.PAGE.DEMOTE does the following:
3. Mark the PAMT_2M or PAMT_1G entry of the large (2MB or 1GB respectively) page as PT_NDA.
 4. Mark all the PAMT_4K or PAMT_2M entries of the small (4KB or 2MB respectively) consecutive leaf pages as PT_REG.
 5. Initialize the new EPT or EPD page with 512 EPT entries pointing to the 512 consecutive leaf pages.
 6. Mark the new EPT or EPD page's PAMT entry as PT_EPT.
- 10 7. Set the parent EPT entry to point to the new EPT or EPD page.

Figure 9.12 below shows the typical state of a 1GB GPA range after TDH.MEM.PAGE.DEMOTE.

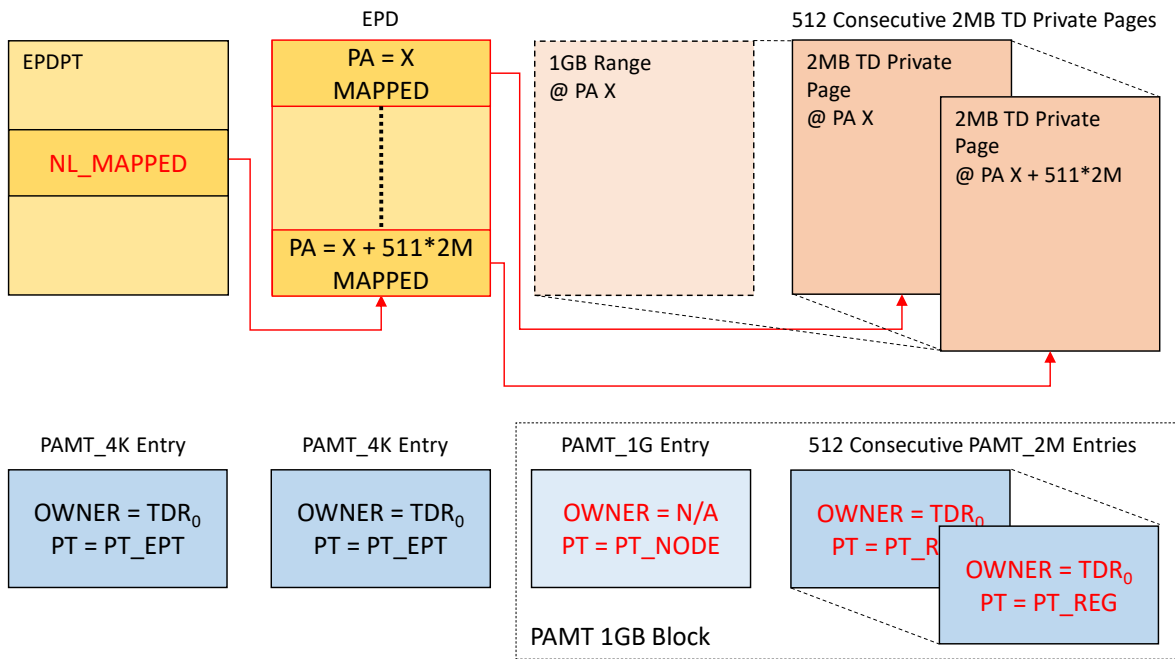

Figure 9.12: Typical State of a 1GB TD Private Range after TDH.MEM.PAGE.DEMOTE

TDH.MEM.PAGE.DEMOTE supports demotion of PENDING pages.

- 15 Refer also to the software flow described in 3.3.1.4.

9.13. Relocating TD Private Pages: TDH.MEM.PAGE.RELOCATE

The host VMM can relocate a 4KB TD private page to another HPA using TDH.MEM.PAGE.RELOCATE. This is useful for, e.g., physical address space de-fragmentation. The host VMM must first perform the TLB tracking protocol on the page.

- 20 The host VMM should first call TDH.MEM.RANGE.BLOCK on the target page. TDH.MEM.RANGE.BLOCK marks the parent EPT entry for that page as **BLOCKED** (if it was MAPPED) or **PENDING_BLOCKED** (if it was PENDING) and records the TD epoch in the PAMT entry of the page.

Typically, the host VMM then calls TDH.MEM.TRACK and performs a round of IPIs. After that, there should be no active address translation to target page.

The actual relocation is done by TDH.MEM.PAGE.RELOCATE which has the following inputs:

- 25
- The page GPA
 - The target HPA to which the page will be relocated

At a high level, TDH.MEM.PAGE.RELOCATE works as follows:

1. Check the TD keys are configured.
 2. Check the TD has been initialized.
- 30 3. Check the target physical page is marked as free in the PAMT.

4. Perform a Secure EPT walk to locate the parent Secure EPT leaf entry that maps the TD private page. Check that the entry has been blocked and get the current HPA.
5. Check the TLB tracking condition for the page.

If all checks pass, TDH.MEM.PAGE.RELOCATE does the following:

- 5 6. Copy the current physical page to the target physical page using direct writes (MOVDIR64B).
7. Mark the PAMT entry of the old physical page as PT_NDA.
8. Mark the PAMT entry of the target page as PT_REG.
9. Update the Secure EPT entry with the new physical page HPA. Set its state to MAPPED or PENDING depending on whether its previous state was BLOCKED or PENDING_BLOCKED, respectively.
- 10 The host VMM should flush the old physical page's cache lines and initialize its content before it is reused, as described in 8.5.1.

9.14. Removing TD Private Pages: TDH.MEM.PAGE.REMOVE

The host VMM can remove TD private pages using TDH.MEM.PAGE.REMOVE, freeing them for any use. 4KB, 2MB and 15 1MB pages can be removed – no demotion is required for large pages. The host VMM should first perform the TLB tracking protocol on the page.

The host VMM should first call TDH.MEM.RANGE.BLOCK on the target page. TDH.MEM.RANGE.BLOCK marks the parent EPT entry for that page as **BLOCKED** (if it was MAPPED) or **PENDING_BLOCKED** (if it was PENDING) and records the TD epoch in the PAMT entry of the page.

Typically, the host VMM then calls TDH.MEM.TRACK and performs a round of IPIs. After that, there should be no active 20 address translation to target page.

The actual removal is done by TDH.MEM.PAGE.REMOVE which has the following inputs:

- The page GPA
- The page level (4KB, 2MB or 1GB)

At a high level, TDH.MEM.PAGE.REMOVE works as follows:

- 25 1. Check the TLB tracking condition for the page.
2. Check that the mapping size of the page fits the input parameter.

If all checks pass, TDH.MEM.PAGE.REMOVE does the following:

3. Mark the EPT entry for the target page as FREE.
4. Mark the PAMT entry of the page as PT_NDA.

30 The host VMM should flush the physical page's cache lines and initialize its content before it is reused, as described in 8.5.1.

Refer also to the software flow described in 3.3.1.2.

9.15. Removing a Secure EPT Page: TDH.MEM.SEPT.REMOVE

35 The host VMM can remove a Secure EPT page using TDH.MEM.SEPT.REMOVE, freeing it for any use, provided all its entries are FREE. The host VMM should first perform the TLB tracking protocol on the page.

The host VMM should first call TDH.MEM.RANGE.BLOCK on the Secure EPT page. TDH.MEM.RANGE.BLOCK marks the parent EPT entry for that page as **BLOCKED** and records the TD epoch in the PAMT entry of the page.

Typically, the host VMM then calls TDH.MEM.TRACK and performs a round of IPIs. After that, there should be no active address translation to GPA range presented by the Secure EPT page to be removed.

40 The actual removal is done by TDH.MEM.SEPT.REMOVE which has the following inputs:

- The Secure EPT page GPA
- The EPT level

At a high level, TDH.MEM.SEPT.REMOVE works as follows:

- 45 1. Check the TLB tracking condition for the page.
2. Check that the mapping size of the page fits the input parameter.
3. Check that all 512 entries of the Secure EPT page are PT_NDA.

If all checks pass, TDH.MEM.SEPT.REMOVE does the following:

4. Mark the EPT entry for the Secure EPT page as FREE.
5. Mark the PAMT entry of the Secure EPT page as PT_NDA.

The host VMM should flush the former SEPT physical page's cache lines and initialize its content before it is reused, as described in 8.5.1.

9.16. *Unlocking a GPA Range: TDH.MEM.RANGE.UNBLOCK*

The host VMM can unblock previously blocked TD private GPA ranges using TDH.MEM.RANGE.UNBLOCK, returning them to their original state. 4KB, 2MB and 1MB GPA ranges can be unblocked.

The host VMM should first complete the TLB tracking protocol on the GPA range. It typically calls TDH.MEM.TRACK and performs a round of IPIs. After that, there should be no active address translation to target page.

The actual unblocking is done by TDH.MEM.RANGE.UNBLOCK which has the following inputs:

- The GPA
- The GPA range level (4KB, 2MB or 1GB)

At a high level, TDH.MEM.RANGE.UNBLOCK works as follows:

1. Check the TLB tracking condition for the GPA range.
2. Check that the mapping size of the GPA range fits the input parameter.

If all checks pass, TDH.MEM.RANGE.UNBLOCK does the following:

3. Mark the EPT entry for the target GPA as MAPPED (if it was BLOCKED) or PENDING (if it was PENDING_BLOCKED).

Refer also to the software flow described in 3.3.1.5.

DRAFT

10.TD VCPU

This chapter discusses multiple items related to TD VCPUs.

10.1. UPDATED: VCPU Transitions

This section describes transitions between running in the host VMM, TDX module and guest TD VCPU.

5 **Note:** Additional transitions that are applicable to partitioned TDs are discussed in the [TD Partitioning Spec].

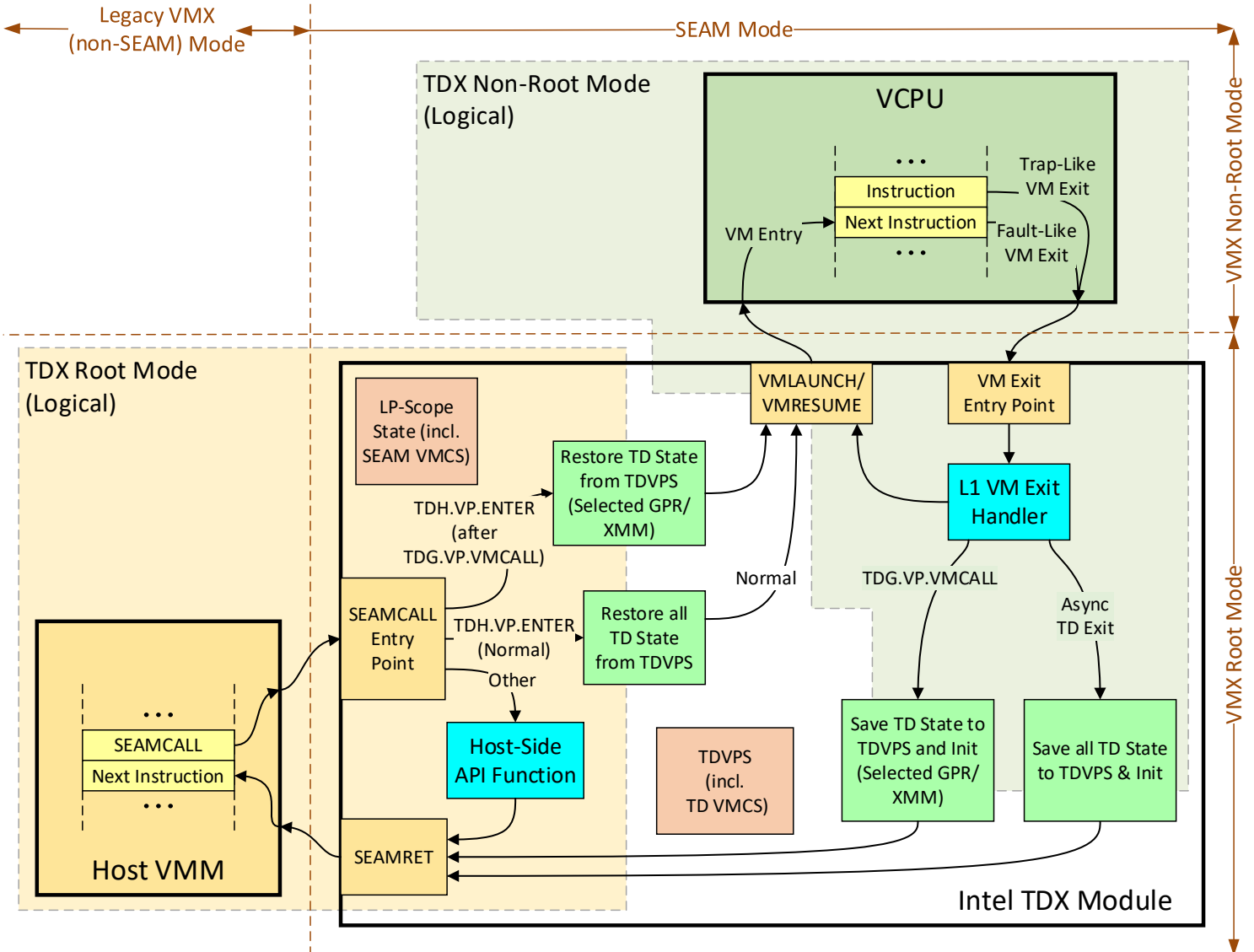

Figure 10.1: TD VCPU Transitions Overview

10.1.1. Initial TD Entry, Asynchronous TD Exit and Subsequent TD Entry

On the initial TD entry to a TD VCPU, the TDX module restores the initial TD VCPU state from TDVPS (including TD VMCS).

10 Following a successful TDH.VP.ENTER, asynchronous TD exit may happen as a result of events such as interrupts, EPT violations etc. In such case, the TDX module saves the TD VCPU state into TDVPS (including TD VMCS). Most of the host VMM VCPU state that may have been used by the TD is initialized. For a detailed description of VMM state following TDH.VP.ENTER, see the [TDX Module ABI Spec].

15 On the subsequent TD entry following an asynchronous TD exit, the TDX module restores the TD VCPU state from TDVPS (including TD VMCS). The host VMM does not impact the VCPU state except in one case: a trap-like asynchronous TD exit from a guest-side interface function may indicate that the host VMM can apply a recoverability hint in the following TD entry. In this case, the host VMM provides a recoverability hist to the guest TD, which is combined into the guest-side interface function’s completion status returned in RAX.

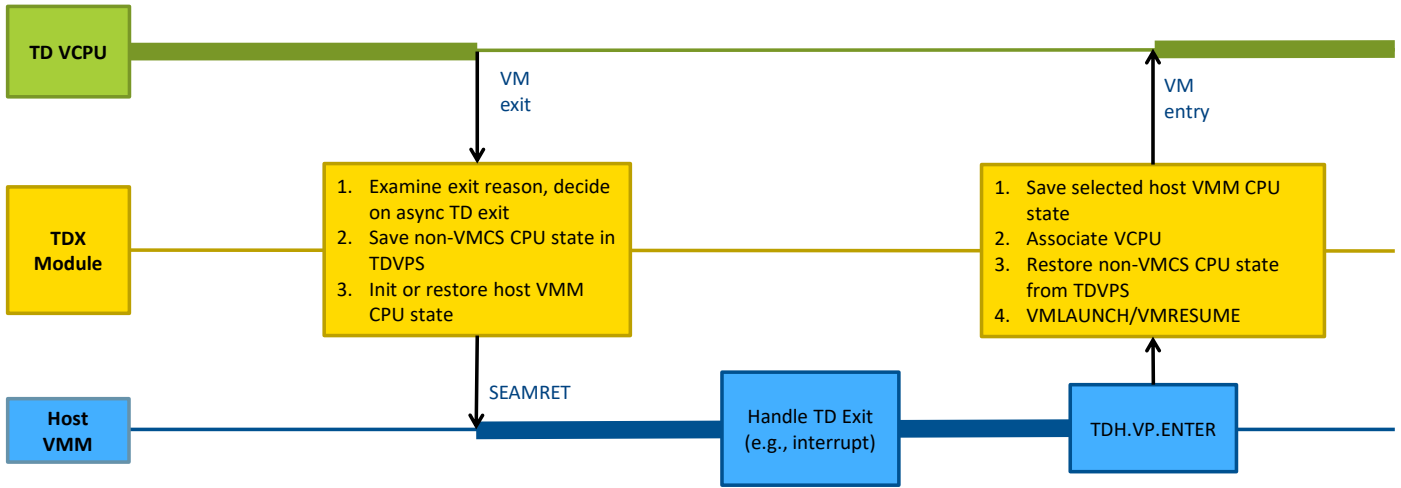

Figure 10.2: Example of Asynchronous TD Exit and TD Resumption

10.1.2. Synchronous TD Exit and Subsequent TD Entry

- 5 TDG.VP.VMCALL provides a channel for the guest TD to communicate with the host VMM.
- The guest TD can initiate a synchronous TD exit by invoking TDG.VP.VMCALL. The RCX input parameter of selects the GPRs (from RBX, RDX, RBP, RDI, RSI and R8 through R15) and XMM registers whose value is passed through to the host VMM as the output of TDH.VP.ENTER. RCX itself is passed as-is to the output of TDH.VP.ENTER. Other CPU state components, including GPRs and XMM registers not selected by RCX, are saved in TDVPS and set to fixed values.
- 10 On the subsequent TDH.VP.ENTER, the RCX value that was used for TDG.VP.VMCALL selects the GPRs (from RBX, RDX, RBP, RDI, RSI and R8 through R15) and XMM registers whose value is passed through to the guest TD. Other CPU state components, including GPRs and XMM registers not selected by RCX, are restored from RCX.
- For details, see the TDH.VP.ENTER and TDG.VP.VMCALL definitions in the [TDX Module ABI Spec].

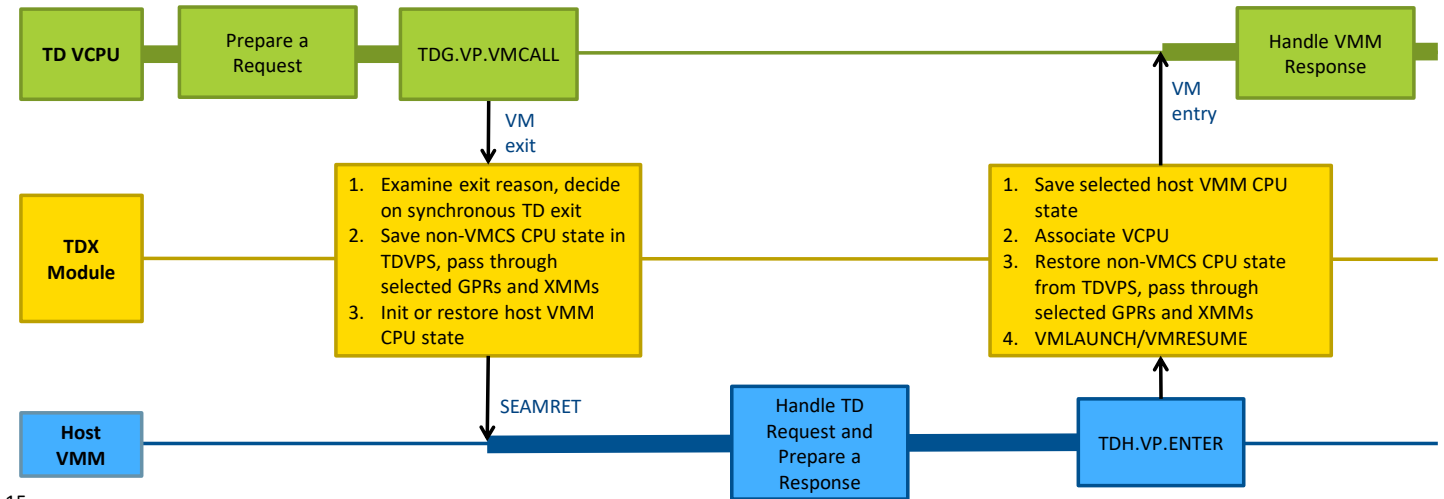

Figure 10.3: Example of Synchronous TD Exit and TD Resumption

10.1.3. UPDATED: VCPU Activity State Machine

The VCPU activity state machine, controlled by TDVPS.VCPU_STATE as shown in Table 10.1 below and shown in Figure 10.4 below, helps ensure the following:

- 20
- A VCPU can be entered only when its logical TDVPS control structure, composed of TDVPR and TDCX pages, is available in memory and has been initialized by TDH.VP.INIT or successfully imported by TDH.IMPORT.STATE.VP.
 - A VCPU can be entered only if its state is consistent (no non-recoverable TD exit happened).
 - TD entry is done properly, depending on whether it is the first entry or on the last TD exit type.

Table 10.1: TDVPS.VCPU_STATE Definition

State Name	Description
VCPU_UNINITIALIZED	VCPU has not been initialized yet by TDH.VP.INIT.
VCPU_IMPORT	The VCPU state has been incompletely imported.
VCPU_READY	The VCPU is ready to be executed.
VCPU_ACTIVE	VCPU is active (logical TDX non-root mode) on some LP. <i>For a partitioned TD, a VCPU is considered active regardless of whether it executes in the L1 VM or one of the L2 VMs. For details, see the [TD Partitioning Spec].</i>
VCPU_DISABLED	VCPU is being torn down.

TD Entry and TD Exit transitions normally toggle between the VCPU_READY state and the VCPU_ACTIVE state, except when a non-recoverable VCPU TD Exit (due to a Triple Fault) transitions to a VCPU_DISABLED state.

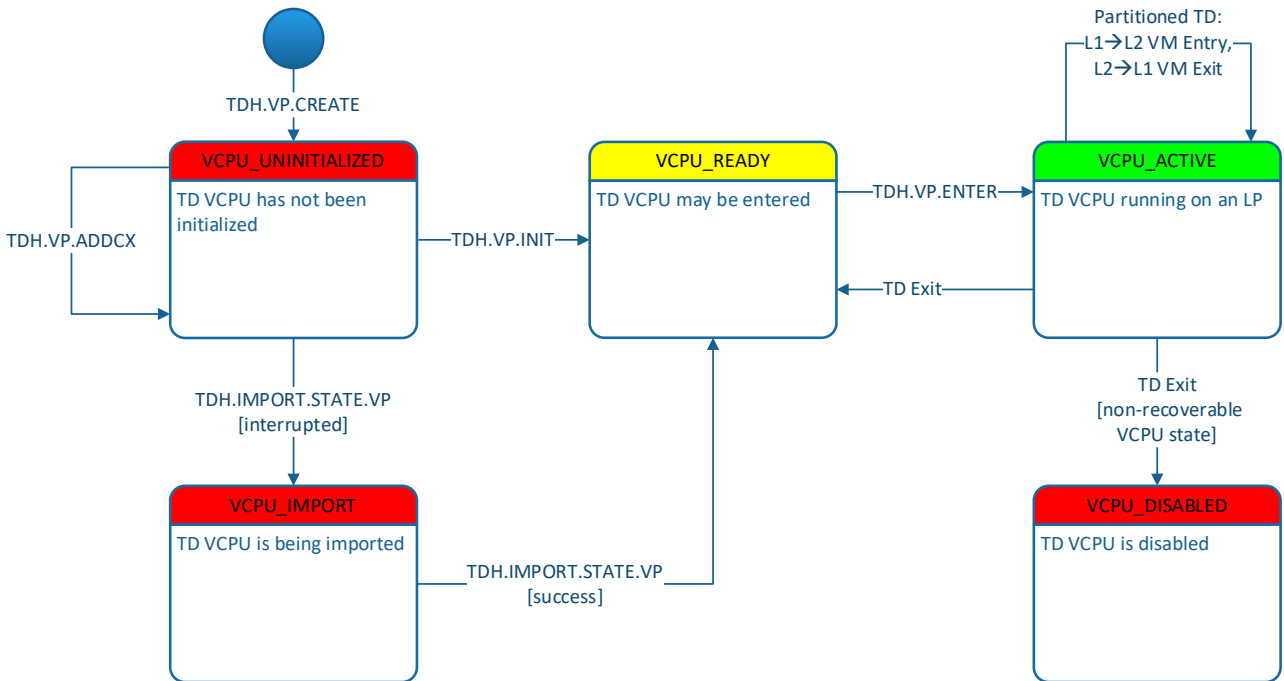

Figure 10.4: UPDATED: VCPU Activity State Machine

LAST_TD_EXIT

In the VCPU_READY and VCPU_IMPORT states, a LAST_TD_EXIT sub-state indicates what was the last TD exit and how a subsequent TD entry should be done.

Table 10.2: TDVPS.LAST_TD_EXIT Definition

Name	Description
ASYNC_FAULT	Last TD exit was due to an asynchronous event (non-TDG.VP.VMCALL) which caused a fault-like exit, i.e., the VCPU state is as if the guest instruction has not been executed. VCPU state has been fully saved on TD exit and will be restored on the next TD entry.
ASYNC_TRAP	Last TD exit was due to an asynchronous event that happen as part of a guest-side interface function (non-TDG.VP.VMCALL) which caused a trap-like exit, i.e., the VCPU state is as if the guest instruction has been executed. VCPU state has been fully saved on TD exit and will be restored on the next TD entry. On the next TD entry, the host VMM provides the guest with a recoverability hint.

Name	Description
TDVMCALL	Last TD exit was due to a TDG.VP.VMCALL. On the next TD entry, most GPR and all XMM state will be forwarded to the guest TD from the host VMM.

CURR_VM

For a partitioned TD, CURR_VM indicates the current VM index for the VCPU. For details, see the [TD Partitioning Spec].

10.2. UPDATED: TD VCPU TLB Address Space Identifier (ASID)

- 5 Non-root mode cached address translations are tagged with unique Address Space Identifiers (ASIDs). The goal of TD ASIDs is to reduce the need to flush TLB entries on TD Entry and TD Exit due the associated performance costs as a result of the flushing.

10.2.1. UPDATED: TD ASID Components

Table 10.3 below shows a high-level view of the components of the TD ASID. The exact structure is micro-architectural.

Table 10.3: TD ASID

Field	Size (Bits)	Description and TDX Usage
SEAM	1	This is an implicit bit 16 of VPID not directly visible to software. It is set to 1 by the CPU in SEAM mode. This bit prevents overlap with legacy (non-TDX) ASIDs.
VPID	16	The TDX module assigns a platform unique VPID for each TD. If a TD is partitioned, the TDX module assigns a platform unique VPID for each VM in that TD. See the [TD Partitioning Spec] for details.
EPTP	40	Bits [51:12] of the EPTP, which for a TD points to the Secure EPT root – HKID bits are cleared to 0 Note that EPTP is unique per TD and is used as an ASID component for both Secure EPT and Shared EPT translations caching.
PCID	16	Same as legacy PCID

Note: All VCPUs of the same TD share the same ASID. Consequently, whenever TDH.VP.ENTER is invoked on a certain LP, with a VCPU that is different than the last one that executed on that LP, the TDX module flushed cached TLB translations for the TD, using INVEPT.

10.2.2. UPDATED: INVEPT by the Host VMM for Managing the Shared EPT

The same ASID based on the TD's EPTP is used for caching both secure and shared EPT translations (remember: EPTP is the HPA of the **secure** EPT root page). Thus, to flush shared EPT translations, the host VMM uses INVEPT specifying the TD's EPTP, not its Shared EPTP. The host VMM can obtain the value of EPTP from the TD VMCSs using TDH.VP.RD.

If a TD is partitioned, then to flush shared EPT translations for each L2 VM, the host VMM uses INVEPT specifying that L2 VM's EPTP, not its Shared EPTP. The host VMM can obtain the value of EPTP from the L2 VMCSes using TDH.VP.RD.

An alternative method the host VMM may use is to do TLB tracking similar to how it's done for Secure EPT, i.e., execute TDH.MEM.TRACK and a round of IPI. Contrary to Secure EPT, this is not enforced by the TDX module.

10.3. VCPU-to-LP Association

10.3.1. Non-Coherent Caching

Some TD VCPU state is non-coherently cached. This includes:

- Address translations (TLB/PxE entries) must be explicitly flushed in case they may be stale.
- TD VMCS is cached by the CPU. VMX architecture requires making a VMCS current by VMPTRLD before using it with most VMX instructions, and then explicitly writing it to memory and making it non-current by VMCLEAR before the VMCS memory image can be handled (e.g., by making it current on another LP).

This non-coherent caching implies that some explicit and/or implicit operations are done to help guarantee correctness. This is described in the following sections.

10.3.2. Intel TDX Functions for VCPU-LP Association and Dis-Association

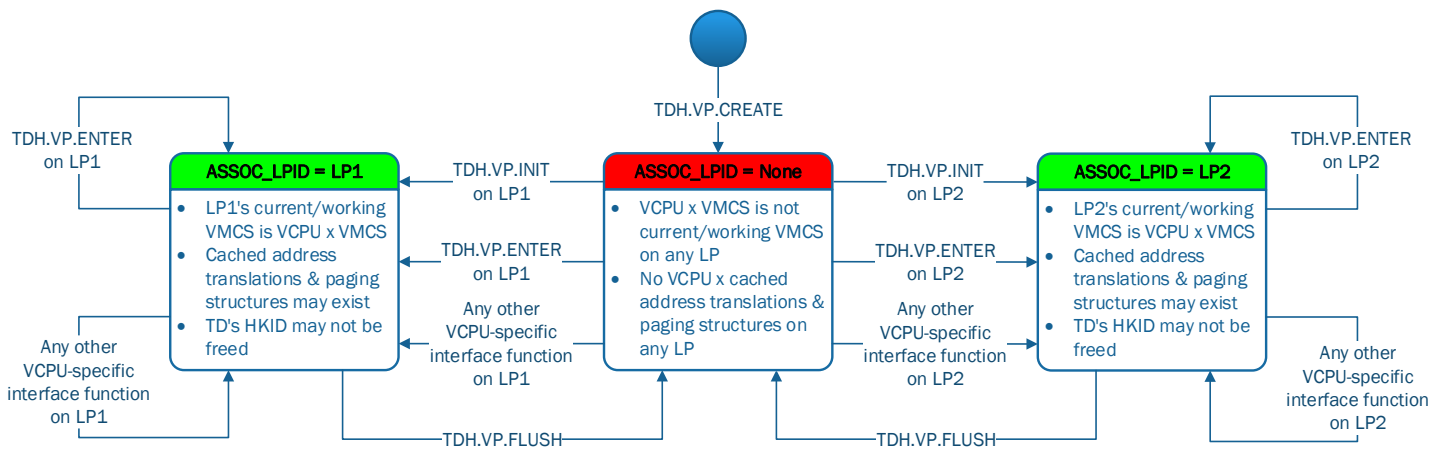

Figure 10.5: VCPU Association State Machine

The following Intel TDX module mechanisms are designed to help ensure correct and secure operation:

- TD VCPU to LP association is many-to-one. A TD VCPU can be associated with at most one LP at any given time. An LP may be associated with multiple VCPUs.
- VCPU to LP association is implicitly done by any VCPU-specific SEAMCALL flow, including TDH.VP.ENTRY. Those flows check that the VCPU is either already associated with the current LP or is not associated with any LP.
- If the host VMM wishes to associate a VCPU with another LP, it must explicitly flush the VCPU state on the LP currently associated with it using **TDH.VP.FLUSH**. This function flushes TLB for the TD ASID and extended paging structure (EPxE) caches using INVEPT. It flushes the VMCS cache using VMCLEAR. For details, see the [TDX Module ABI Spec].
- If the VMM wishes to reclaim the TD's private HKID, thus making the TDVPS memory inaccessible, it must explicitly flush the VCPU state on the LP currently associated with it. This is described in 5.4.

10.3.3. Performance Considerations

- Migrating VCPUs between LPs is costly. As described above, it involves flushing address translation caches, paging structure caches and VMCS cache. The host VMM should minimize that for best performance.
- Address translation and paging structure caches are flushed at TD-scope on the current LP. This flushing impacts the (possibly non-typical) case where multiple VCPUs of the same TD are associated with a single LP.

11. UPDATED: CPU Virtualization (Non-Root Mode Operation)

This chapter describes how the Intel TDX module virtualizes the CPU to a guest TD.

11.1. Initial State

Intel SDM, Vol. 3, 9.1.1 Processor State after Reset

11.1.1. Overview

As designed, most of the TD VCPU initial state is the same as the processor architectural state after INIT. However, there are some differences:

- The TD VCPU starts its life in protected (32-bit) non-paged mode, not in real mode. It is allowed only to switch to 64b mode. This impacts the initial state of segment registers, CRs and MSRs. Mode restrictions in SEAM non-root mode are described below.
- The IA32_EFER MSR is initialized to support the CPU modes described below.
- The initial values of some GPRs provide some basic information to the guest TD as described in 11.1.2 below. This information should be sufficient for the vBIOS to set up paging tables and switch as soon as possible to 64b mode, where it can use the TDCALL leaf functions.

See also the TDVPS fields and TD VMCS guest state area in the [TDX Module ABI Spec].

11.1.2. Initial State of Guest TD GPRs

As designed, the following initial state is different than the architectural INIT state:

Table 11.1: Initial Values of GPRs Different from their Architectural INIT Values

Register	Bits	Initial Value
RBX	5:0	GPAW, the effective GPA width (in bits) for this TD (do not confuse with MAXPA) – SHARED bit is at GPA bit GPAW-1 Only GPAW values 48 and 52 are possible.
	63:6	Reserved: set to 0
RCX, R8	63:0	The value of RCX and R8 is provided as an input to TDH.VP.INIT (the same value in both GPRs). No checking is done on this value; the intention is for vBIOS to read RCX immediately after the first TDH.VP.ENTER and use the RCX value appropriately as set by software convention.
RDX	31:0	Set to the virtualized Family/Model/Stepping returned by CPUID(1).EAX. The value is calculated by TDH.SYS.INIT as to have the minimum Stepping ID across all packages.
	63:32	Reserved: set to 0
RSI	31:0	Virtual CPU index, starting from 0 and allocated sequentially on each successful TDH.VP.INIT
	63:32	Reserved: set to 0
RIP	63:0	Set to 0xFFFFFFFF (i.e., 4GB - 16B)

11.1.3. Initial State of CRs

As designed, the following initial state is different than the architectural INIT state:

- CR0 is initialized to 0x0021 – bits PE (0) and NE (5) are set to 1, and all other bits are cleared to 0. See 11.6.1 for details.
- CR4 is initialized to 0x2040 – bits MCE (6) and VMXE (13) are set to 1, and all other bits are cleared to 0. Note that the virtualized value of VMXE is 0, due to the setting of the TD VMCS “CR4 guest/host mask” and “CR4 read shadow” controls. See 11.6.2 for details.

11.1.4. Initial State of Segment Registers

As designed, the following initial state is different than the architectural INIT state:

- CS, DS, ES, FS, GS and SS are initialized with a base of 0 and limit of 0xFFFFFFFF.
- LDTR, TR and GDTR are initialized with a base of 0 and limit of 0xFFFF.
- IDTR is initialized as invalid (limit of 0).

For details, see the [TDX Module ABI Spec].

11.1.5. Initial State of MSRs

As designed, the following initial state is different than the architectural INIT state:

- IA32_EFER is initialized to 0x901 – SCE (bit 0), LME (bit 8) and NXE (bit 11) are set to 1, and all other bits are cleared to 0.

11.2. UPDATED: Guest TD Run Time Environment Enumeration

Guest software can be designed to run either as a TD, as a legacy virtual machine, or directly on the CPU, based on enumeration of its run-time environment. Figure 11.1 below shows a typical flow used by guest software.

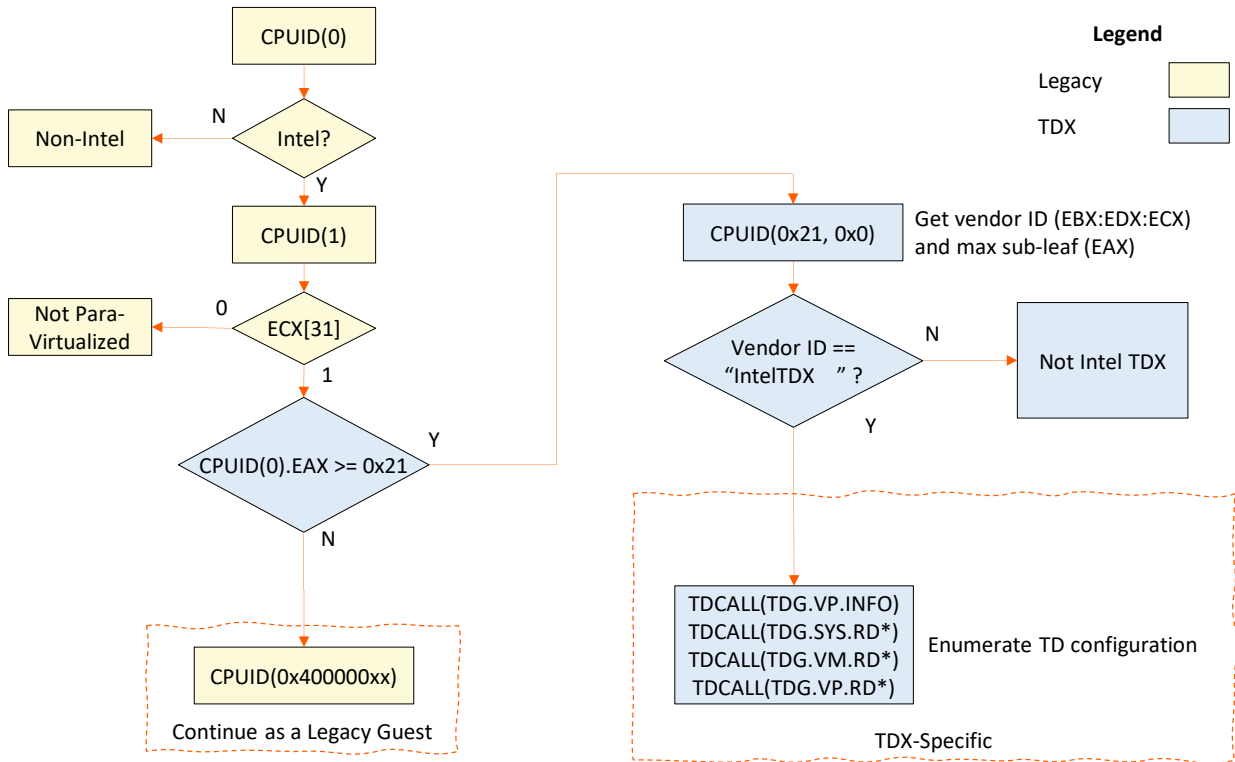

Figure 11.1: UPDATED: Typical Run-Time Environment Enumeration by a Guest TD

CPUID leaf 0x21 emulation is done by the Intel TDX module. Sub-leaf 0 returns the values shown below. Other sub-leaves return 0 in EAX/EBX/ECX/EDX.

Table 11.2: TDX Enumeration by CPUID(0x21,0)

GPR	Value (Hex)	Description
EAX	0x00000000	Maximum sub-leaf number
EBX	0x65746E49	“Inte”
ECX	0x20202020	“ ”
EDX	0x5844546C	“1TDX”

Once the guest software discovers that it runs as a TD, it can use TDG.VP.INFO to get basic information. It can also use the metadata read functions TDG.SYS.RD*, TDG.VM.RD* and TDG.VP.RD*.

11.3. CPU Mode Restrictions

Intel SDM, Vol. 3, 2.2	Modes of Operation
Intel SDM, Vol. 3, 9.8.5	Initializing IA-32e Mode
Intel SDM, Vol. 3, 11.5.1	Cache Control Registers and Bits
Intel SDM, Vol. 3, 24.6.6	Guest/Host Masks and Read Shadows for CR0 and CR4

A TD OS running in SEAM non-root mode is required to be a 64-bit OS. The Intel TDX module helps enforce this with the restrictions described below.

Table 11.3: CPU Mode Restrictions in SEAM Non-Root Mode

Restriction	Description
CPU and Paging Modes	<p>In SEAM non-root mode, the CPU is allowed to run in the following modes:</p> <ul style="list-style-type: none"> Protected mode (32-bit) with no paging (CR0.PG == 0) IA-32e mode with 4-level or 5-level paging (CR0.PG == 1), with the sub-modes controlled by CS.L: <ul style="list-style-type: none"> 64-bit mode Compatibility (32-bit) mode <p>To achieve this, CR0.PE and IA32_EFER.LME are enforced to 1, as described in the following sections.</p>
Execute Disable	<p>When running in IA-32e mode, the PT Execute Disable bit (63) is always enabled.</p> <p>To achieve this, IA32_EFER.NXE is enforced to 1, as described in the following sections.</p>
Caching is Always Enabled	<p>The guest TD runs in Normal Cache Mode.</p> <p>To achieve this, CR0.CD and CR0.NW are enforced to 0, as described in the following sections.</p>

11.4. Instructions Restrictions

The Intel TDX module is designed to block certain instructions from executing in TDX non-root mode. Execution of those instructions results in a VM exit to the Intel TDX module, which then injects an exception to the guest TD. This exception can be #UD, a #GP(0) or, in case where no Intel64 architectural exception can be used, a #VE (described in 11.10).

11.4.1. Unconditionally Blocked Instructions

11.4.1.1. Instructions that Cause a #UD Unconditionally

- ENCLS, ENCLV
- Most VMX instructions: INVEPT, INVVPID, VMCLEAR, VMFUNC, VMLAUNCH, VMPTRLD, VMPTRST, VMREAD, VMRESUME, VMWRITE, VMXOFF, VMXON
- RSM
- GETSEC
- SEAMCALL, SEAMRET

11.4.1.2. Instructions that Cause a #VE Unconditionally

- String I/O (INS*, OUTS*), IN, OUT
- HLT
- MONITOR, MWAIT
- WBINVD, INVD
- VMCALL

11.4.1.3. Instructions that Cause a #UD or #VE Depending on Feature Enabling

- PCONFIG (see 11.15)

11.4.1.4. Other Cases of Unconditionally Blocked Instructions

- Guest TD execution of ENQCMD results in a #GP(0).
- Guest TD execution of ENQCMDs when CPL is 0 results in a #UD. Otherwise, it results in a #GP(0).

11.4.2. Conditionally Blocked Instructions

Execution of some instructions may be conditionally blocked, depending on which CPU features are configured and available for the TD, as described in the following sections.

11.4.3. Other Exception Cases

In many cases, instructions are not blocked but yet may cause exceptions due to other conditions. For example, following is a very partial list:

- CPUID may cause a #VE if the CPUID leaf and sub-leaf are not virtualized by the TDX module.
- RDMSR and WRMSR may cause a #GP(0) if an MSR is virtualized as non-existing, or a #VE if an MSR is not virtualized.

11.5. Extended Feature Set

Intel SDM, Vol. 1, 13 Managing State Using the XSAVE Feature Set
Intel SDM, Vol. 3, 13 System Programming for Instruction Set Extensions and Processor Extended State

11.5.1. Allowed Extended Features Control

At the guest TD scope, **TDCS.XFAM (Extended Features Allowed Mask)** is provided as an input during guest TD build process. XFAM is a 64b mask, using the **state-component bitmap** format used by extended state ISA (XSAVE, XRSTOR, XCRO, IA32_XSS etc.), which specifies the set of extended features the TD is allowed to use.

XFAM is checked to be compliant with the set of extended features supported by the CPU, as enumerated by CPUID and the allowed bit combinations, as shown in Table 11.4 below.

11.5.2. Extended State Isolation

The Intel TDX module helps ensure that any guest TD extended state is saved and isolated from the host VMM across TD exit and entry. It is the VMM's responsibility to save its own extended state across TD entry and exit.

- Before TDH.VP.ENTER, the host VMM should save (e.g., using XSAVES) any extended state that the guest TD VCPU is allowed to use (per XFAM) and the host VMM expects to need after TDH.VP.ENTER is complete.
- The TDH.VP.ENTER function loads the extended state that the TD VCPU is allowed to use, per XFAM, from the VCPU's TDVPS. An exception to this is when TDH.VP.ENTER follows a previous TDG.VP.VMCALL – in the case TDH.VP.ENTER does not load the XMM state (corresponding to XFAM bit 1) from TDVPS; it passes it directly from the host VMM.
- On an asynchronous TD exit, the Intel TDX module saves the extended state that the TD VCPU was allowed to use, per XFAM, to the VCPU's TDVPS. It then clears the extended state.
- On TDG.VP.VMCALL, the Intel TDX module works similarly, but it selectively does not clear some of the XMM register state (corresponding to XFAM bit 1). That XMM state is passed directly to the host VMM.
- On completion of TDH.VP.ENTER (following TD exit), the VMM may restore any extended state that it saved before TDH.VP.ENTER.

11.5.3. Extended Features Execution Control

The Intel TDX module is designed to prohibit the guest TD from using any extended feature not allowed by XFAM. Many extended state features are controlled by XCRO and IA32_XSS MSR. Other features are controlled by CR4 or by specific MSRs.

XCRO and IA32_XSS MSR On XSETBV, which attempts to write to XCRO, and on WRMSR of IA32_XSS, the TDX module emulates the architectural behavior of the CPU. The following cases cause a #GP(0):

- The new value is not natively valid for XCRO or IA32_XSS (it sets reserved bits, sets bits for features not recognized by the Intel TDX module, or uses invalid bit combinations).
- The new value has any bits set that are not allowed by XFAM.

CR4 On MOV to CR4, the guest TD attempts to set bits not allowed according to XFAM will cause a #GP(0).

Other MSRs The guest TD attempts to write or read certain MSRs that are not enabled according to XFAM can cause a #GP(0) or a #VE, as described below.

The following table describes how a guest TD executes each of the extended features.

Table 11.4: Extended Features Enumeration and Execution Control

Bits	U/S	Feature	Enumeration ⁶	XFAM Value	Description
0	U	FP	Always available	1	Always enabled
1	U	SSE	Always available	1	Always enabled
2	U	AVX	CPUID(0xD,0x0).EAX[2] CPUID(0x7,0x0).EBX[2] CPUID(0x7,0x0).ECX[10:9] CPUID(0x7,0x1).EAX[5] CPUID(0xD, 0x2).*	0 or 1	Execution is directly controlled by XCRO.
4:3	U	MPX	CPUID(0xD,0x0).EAX[4:3] CPUID(0x7,0x0).EBX[14] CPUID(0xD, 0x3).* CPUID(0xD, 0x4).*	00	MPX is being deprecated.
7:5	U	AVX512	CPUID(0xD,0x0).EAX[7:5] CPUID(0x7,0x0).EBX[31:30, 28:26, 21, 17:16] CPUID(0x7,0x0).ECX[14, 12:11, 6, 1] CPUID(0x7,0x0).EDX[8] CPUID(0x7,0x1).EAX[5] CPUID(0xD, 0x5).* CPUID(0xD, 0x6).* CPUID(0xD, 0x7).*	000 or 111	Execution is directly controlled by XCRO. AVX512 may be enabled only if AVX is enabled – i.e., XFAM[7:5] may be set to 111 only when XFAM[2] is set to 1.
8	S	PT (RTIT)	CPUID(0xD,0x1).ECX[8] CPUID(0x7,0x0).EBX[25] CPUID(0x14).* CPUID(0xD, 0x8).*	0 or 1	Execution is controlled by IA32_RTIT_CTL. If PT is enabled by XFAM, the guest TD is allowed access to all IA32_RTIT_* MSRs. Otherwise, any access causes #GP(0).
9	U	PK	CPUID(0xD,0x0).EAX[9] CPUID(0xD, 0x9).*	0 or 1	Execution is controlled by CR4.PKE (bit 22). If PK is disabled by XFAM, the guest TD is disallowed from setting CR4.PKE. An attempt to set this bit causes a #GP(0).

⁶ An extended feature controlled by bits N:M is available if all bits in the range N:M returned by CPUID are set to 1.

Bits	U/S	Feature	Enumeration ⁶	XFAM Value	Description
10	S	ENQCMD (PASID)	CPUID(0xD,0x1).ECX[10] CPUID(0xD, 0xA).*	0	Execution is controlled by IA32_PASID MSR. There is no direct I/O from guest TDs. ENQCMD and ENQCMDs from the guest TD are not supported and cause a #UD or #GP(0) (see 11.4.1.4). Access to IA32_PASID causes a #GP(0).
12:11	S	CET	CPUID(0xD,0x1).ECX[12:11] CPUID(0xD, 0xB).* CPUID(0xD, 0xC).*	00 or 11	Execution is controlled by CR4.CET (bit 23). If CET is disabled by XFAM, the guest TD is disallowed from setting CR4.CET. An attempt to set this bit causes a #GP(0).
13	S	HDC	CPUID(0xD,0x1).ECX[13] CPUID(0xD, 0xD).*	0	Hardware Duty Cycle is controlled by package-scope IA32_PKG_HDC_CTL and LP-scope IA32_PM_CTL1 MSRs. HDC is disabled. Any guest TD access to the above MSRs causes a #VE.
14	S	ULI	CPUID(0xD,0x1).ECX[14] CPUID(0x7,0x0).EDX[5] CPUID(0xD, 0xE).*	0 or 1	Execution is controlled by CR4.UINTR (bit 25). If ULI is disabled by XFAM, then: <ul style="list-style-type: none"> The guest TD is disallowed from setting CR4.ULI. An attempt to set this bit causes a #GP(0). The guest TD is disallowed access to all IA32_UINTR_* MSRs. Any access causes a #GP(0).
15	S	LBR	CPUID(0xD,0x1).ECX[15] CPUID(0x7,0x0).EDX[19] CPUID(0xD, 0xF).* CPUID(0x1C).*	0 or 1	Execution is controlled by IA32_LBR_CTL. If LBR is disabled by XFAM, the guest TD is disallowed access to all IA32_LBR_* MSRs. Any access causes a #GP(0).
16	S	HWP	CPUID(0xD,0x1).ECX[16] CPUID(0xD, 0x10).*	0	Execution of Hardware-Controlled Performance State is controlled by IA32_HWP MSRs. This feature is disabled. Access to any of the above MSRs causes a #VE.
18:17	U	AMX	CPUID(0xD,0x0).EAX[18:17] CPUID(0xD, 0x11).* CPUID(0xD, 0x12).*	00 or 11	Advanced Matrix Extensions (AMX) is directly controlled by XCRO.

11.6. UPDATED: CR Handling

11.6.1. CR0

Intel SDM, Vol. 3, 2.5	Control Registers
Intel SDM, Vol. 3, 23.8	Restrictions on VMX Operation
Intel SDM, Vol. 3, 24.6.6	Guest/Host Masks and Read Shadows for CR0 and CR4
Intel SDM, Vol. 3, 25.6	Unrestricted Guests

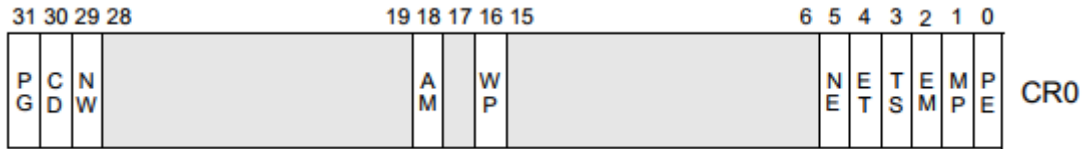

Figure 11.2: CR0

From the guest TD's point of view, as virtualized by the Intel TDX module, CR0 bits PE (0) and NE (5) are always set to 1, and bits NW (29) and CD (30) are always cleared to 0.

Guest TD writes to CR0 are handled by the Intel TDX module as follows:

- Writes to CR0 that are architecturally invalid (such as attempts to set bits that must be 0) or writes to CR0 that set architecturally invalid bit combinations, result in a #GP(0).
- Writes to CR0 that are architecturally invalid, but not permitted by the TDX architecture (such as clearing CR0.CD) result in a #VE.
- Other writes are allowed.

For TD migration, the same rules are used for checking the imported value of guest CR0. Any violation results in a failed import.

11.6.2. UPDATED: CR4

Intel SDM, Vol. 3, 24.6.6	Guest/Host Masks and Read Shadows for CR0 and CR4
---------------------------	---

If a CPU feature is not enabled for the guest TD, the guest TD's attempt to set the corresponding CR4 bit can result in a #GP(0):

- Depending on the TD's XFAM, guest TD modification of CR4 bits PKE (22), CET (23) and UINTR (25) is prevented. Any guest TD attempt to change those bits results in a #GP(0).
- If the TD's ATTRIBUTES.KL is 0, guest TD attempts to set bit KL (19) results in a #GP(0).
- If the TD's ATTRIBUTES.PKS is 0, guest TD attempts to set bit PKS (24) results in a #GP(0). See 11.14 below.

In addition, any guest TD attempts to modify any of the architecturally reserved CR4 bits, or to set architectural-invalid bit combinations, can result in a #GP(0).

From the guest TD's point of view, the following bits are virtualized as fixed by Intel TDX module. Guest TD attempts to modify their values result in a #VE:

- CR4 bit MCE (6) is fixed to 1.
- CR4 bits VMXE (13) and SMXE (14) are fixed to 0.

For TD migration, the same rules are used for checking the imported value of guest CR4. Any violation results in a failed import.

11.7. MSR Handling

11.7.1. Overview

From the guest TD's point of view, as virtualized by the Intel TDX module, MSRs are divided into the following categories:

- MSRs that are context-switched on TD entry and exit – guest TD access to such MSRs may be full, partial or none
- MSRs that are not context-switched, but guest TD access is read-only
- MSRs that are not context-switched, and are inaccessible to the guest TD

MSR behavior can be either fixed or dependent on the TD configuration via the XFAM, ATTRIBUTES and CPUID configuration parameters. The host VMM has no direct interface to configure specific MSR behavior (e.g., it cannot set a specific MSR to TD exit on write). Instead, guest TD access violations to MSRs can cause a #GP(0) in most cases where the MSR is enumerated as inaccessible by the Intel TDX module via CPUID virtualization. In other cases, guest TD access violations to MSRs can cause a #VE. A guest TD that wishes to access an MSR that is not allowed by the Intel TDX module should do so via explicit requests from the host VMM using TDCALL(TDG.VP.VMCALL).

A detailed list of MSR virtualization is provided in the [TDX Module ABI Spec].

11.7.2. NEW: MSR Configuration by the Host VMM

For a few MSRs, the virtualized values of some bit field returned to the guest TD when executing RDMSR can be configured by the host VMM. Configuration is done as an input to TDH.MNG.INIT.

Table 11.5: Host VMM Configurable MSR Field Virtualization

MSR Bit Configuration	Description
ALLOW_DIRECT	An MSR bit's virtual value can be configured as follows: <ul style="list-style-type: none"> • Allowed by the host VMM, i.e., reflects the native value returned by the CPU. • Forced to 0 by the host VMM, regardless of its native values.
FORCE_DIRECT	An MSR bit's virtual value can be configured as follows: <ul style="list-style-type: none"> • Forced to 1 by the host VMM, regardless of whether or not supported by the CPU. • Allowed by the host VMM, i.e., reflects the native value returned by the CPU.

For details, see the TD_PARAMS definition in the [ABI Spec].

Implication on TD Migration

The virtual MSR values calculated on TDH.MNG.INIT are stored in TDCS. If the TD is migrated, the values are exported by TDH.EXPORT.STATE.IMMUTABLE and checked on import to the destination TD by TDH.IMPORT.STATE.IMMUTABLE to be compatible with the destination platform.

For MSR bits that are configurable as ALLOW_DIRECT, an imported value of 0 is always allowed, regardless of the destination CPU's native value.

For MSR bits that are configurable as FORCE_DIRECT, an imported value of 1 is always allowed, regardless of the destination CPU's native value.

11.8. **UPDATED:** CPUID Virtualization

11.8.1. **UPDATED:** CPUID Configuration by the Host VMM

For some CPUID leaves and sub-leaves, the virtualized bit fields of CPUID return values (in guest EAX/EBX/ECX/EDX) are configurable by the host VMM. For such cases, the Intel TDX module architecture defines two virtualization types:

Table 11.6: Host VMM Configurable CPUID Field Virtualization

CPUID Field Virtualization	Description	Comments
As Configured	Bit fields for which the host VMM configures the value seen by the guest TD. Configuration is done on TDH.MNG.INIT.	
As Configured (if Native)	Bit fields for which the host VMM configures the value such that the guest TD either sees their native value or a value of 0. Configuration is done on TDH.MNG.INIT.	If a CPUID bit enumerates a CPU feature, and the feature is natively supported, then the feature can either be allowed by the host VMM, or it will be effectively deprecated for the guest TD.

The above CPUID fields can be specified by the host VMM at guest TD initialization time TDH.MNG.INIT using the TD_PARAMS input structure of TDH.MNG.INIT. TDH.MNG.INIT and its input TD_PARAMS structure are described in the [TDX Module ABI Spec]. Configuration is further classified as follows:

Table 11.7: CPUID Configuration by the TD_PARAMS Input of TDH.MNG.INIT

TD_PARAMS Section	Description	Notes
CPUID_CONFIG	Bit fields configurable directly based on a configuration table	Some bit fields are configurable by both CPUID_CONFIG and either XFAM or ATTRIBUTES. See the discussion below.
XFAM	Bit fields configurable based on the guest TD's XFAM XFAM control of extended features virtualization is described in 11.5.	
ATTRIBUTES	Bit fields configurable based on the guest TD's ATTRIBUTES	
Other	Bits fields configurable based on some other field of TD_PARAMS	

Some CPUID bit fields are configurable based on both CPUID_CONFIG and either XFAM or ATTRIBUTES sections of TD_PARAMS. This is intended to support **fine-grained virtualization of sub-features of extended features**. For example:

- The host VMM can configure the TDX module to virtualize some AVX512 as available, but to virtualize other AVX512 instructions as unavailable.
- The host VMM can configure the TDX module to virtualize the Perfmon architectural events support.

This is useful for TD migration, as it allows the host VMM to configure a common subset of supported sub-features.

A detailed list of CPUID virtualization is provided in the [TDX Module ABI Spec]. For any valid CPUID leaf / sub-leaf combination that is not listed, the Intel TDX module injects a #VE.

The host VMM should always consult the list of directly configurable CPUID leaves and sub-leaves, as enumerated by TDH.SYS.RD/RDALL or TDH.SYS.INFO, described in 4.1.2.4.

11.8.2. Guest TD Control of CPUID Virtualization

11.8.2.1. Unconditional #VE for all CPUID Leaves and Sub-Leaves

The guest TD may toggle on or off the unconditional injection of #VE on all CPUID leaves and sub-leaves, per VCPU. That can be done in supervisor mode (CPL == 0) and/or user mode (CPL > 0). For example, this enables the TD OS to control CPUID as seen by drivers or by user-level code.

The guest TD may do this by writing to the VCPU-scope metadata fields CPUID_SUPERVISOR_VE and CPUID_USER_VE using TDG.VP.WR.

For backward compatibility, the guest TD may use TDG.VP.CPUIDVE.SET, described in the [TDX Module ABI Spec].

11.8.2.2. NEW: Leaf/Sub-leaf Specific Control

A finer grained control is provided per CPUID leaf and sub-leaf that is virtualized by the TDX module. The guest TD may configure the following, per VCPU:

- #VE injection instead of the normal CPUID virtualization is the guest executed CPUID in supervisor mode (CPL == 0).
- #VE injection instead of the normal CPUID virtualization is the guest executed CPUID in user mode (CPL > 0).

The guest TD may do this by writing to the VCPU-scope metadata field array CPUID_CONTROL using TDG.VP.WR.

11.8.3. NEW: CPUID Configuration & Checks at Guest TD Migration

The CPUID virtualization configuration stored in TDCS is exported by TDH.EXPORT.STATE.IMMUTABLE and checked on import to the destination TD by TDH.IMPORT.STATE.IMMUTABLE to be compatible with the destination platform.

CPUID fields that are virtualized as fixed values (defined as “FIXED”), are based on some calculation (defined as “ASSIGNED”) or that their value depends on the underlying CPU capabilities (defined as “ALLOWED” or “DIRECT”) must retain the same value across migration.

CPUID fields that are virtualized as pass-through (defined as “NATIVE”) are considered fixed once exported and are checked for compatibility on import.

11.9. Interrupt Handling and APIC Virtualization

Intel SDM, Vol. 3, 24.6.8 Controls for APIC Virtualization
Intel SDM, Vol. 3, 29 APIC Virtualization and Virtual Interrupts

11.9.1. Virtual APIC Mode

- Guest TDs must use x2APIC mode. xAPIC mode (using memory mapped APIC access) is not allowed.
- Guest TD attempts to RDMSR or WRMSR the IA32_APIC_BASE MSR cause a #VE to the guest TD. The guest TD cannot disable the APIC.

11.9.2. Virtual APIC Access by Guest TD

Intel SDM, Vol. 3, 29.5 Virtualizing MSR-Based APIC Access

Guest TDs are allowed access to a subset of the virtual APIC registers, which are virtualized by the CPU as described in [Intel SDM, Vol. 3, 29.5]. Access to other registers can cause a #VE. The guest TD is expected to use a software protocol over TDG.VP.VMCALL to request such operations from the host VMM.

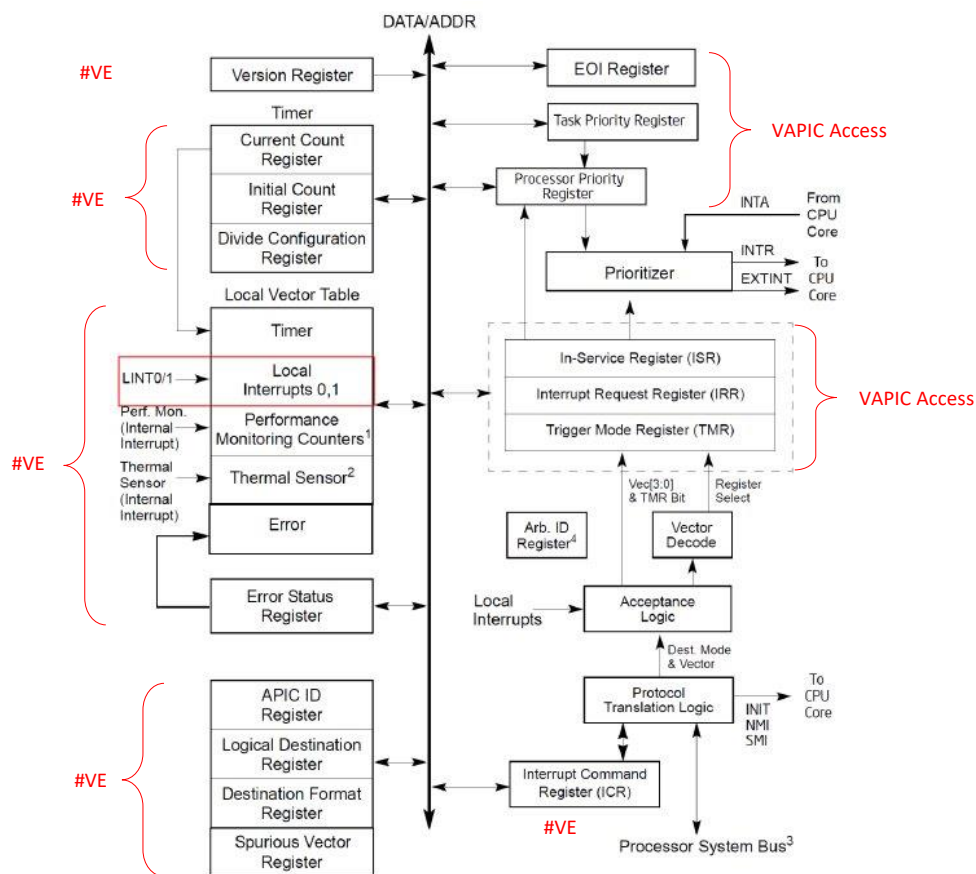

Figure 11.3: Virtual APIC Access by Guest TD

Table 11.8: x2APIC MSRs Access

MSR Range	MSR Name(s)	Description	Operation
0x802	IA32_X2APIC_APICID	APIC ID	#VE
0x803	IA32_X2APIC_VERSION	APIC version	#VE
0x80D	IA32_X2APIC_LDR	Local destination register	#VE
0x80F	IA32_X2APIC_SIVR	Spurious interrupt vector	#VE
0x828	IA32_X2APIC_ESR	Error status	#VE
0x830	IA32_X2APIC_ICR	Interrupt command	#VE
0x82F, 0x837-0x832, 0x83A	IA32_X2APIC_LVT_*	Local vector table registers	#VE
0x838, 0x839, 0x83E	IA32_X2APIC_*_COUNT, IA32_X2APIC_DCR	APIC timer registers	#VE
0x801-0x800, 0x807-0x804, 0x82E-0x829, 0x831, 0x8FF-0x840	Reserved		#GP(0)
Other MSR in the range 0x8FF-0x800			Access to VAPIC page (see [Intel SDM, Vol. 3, 29.5])

11.9.3. Implicit APIC Write #VE

The following guest operations result in an APIC write VM exit to the TDX module. The VM exit is trap-like, i.e., it happens after the instruction has been executed:

- WRMSR of IA32_X2APIC_SELF_IPI with EAX[7:4] set to 0, i.e., an interrupt vector value smaller than 16.
- Executing SENDUIPI to send a user-level interrupt.

In all such cases, the TDX module injects a #VE exception back to the guest TD, with the exit reason indicating an APIC write and bits 11:0 of the exit qualification set to the page offset of the write access.

11.9.4. UPDATED: Posted Interrupts

Intel SDM, Vol. 3, 29.6 Posted-Interrupt Processing

Non-NMI interrupt injection into the guest TD by the host VMM or the IOMMU can be done through the posted-interrupt mechanism. If there are pending interrupts in the posted-interrupt descriptor (PID), the VMM can post a self IPI with the notify vector prior to TD entry.

- The posted-interrupt descriptor (PID) resides in a shared page, directly accessible by the host VMM. The VMM must set the TD VMCS's "posted-interrupt descriptor address" control (using the TDH.VP.WR function) to the PA and shared HKID of the posted-interrupt descriptor.
- The host VMM must set the TD VMCS's "posted-interrupt notification vector" control using the TDH.VP.WR function.
- To post pending interrupts in the PID, the host VMM can generate a self IPI with the notification vector prior to TD entry.

When a posted-interrupt notification vector is recognized in SEAM non-root mode, the CPU processes the posted-interrupt descriptor as described in the [Intel SDM].

If needed, the guest TD may use a software protocol over TDCALL(TDG.VP.VMCALL) to ask the VMM to stop interrupt delivery through the PID.

The TD VMCS posted interrupt execution controls are reset to their initial values when the TD is migrated. The host VMM on the destination platform must set them in order to use posted interrupts.

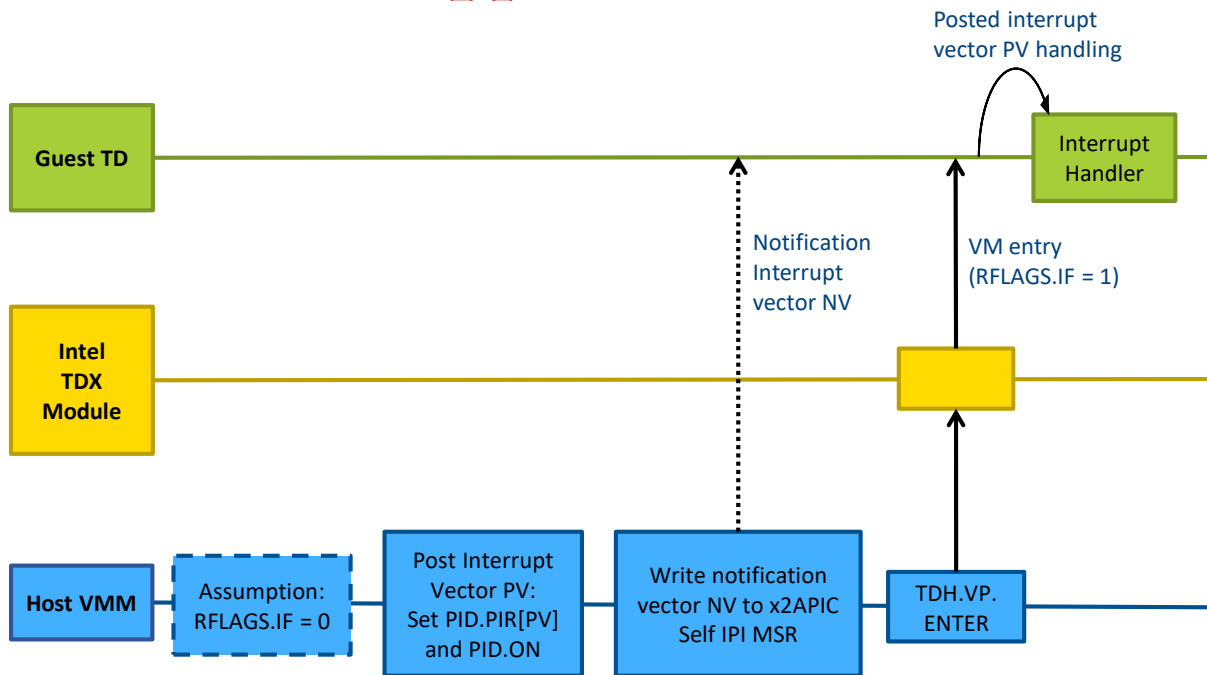

Figure 11.4: Typical Sequence for Posted Interrupt Injection to the Current LP

Posted interrupts handling for partitioned TDs is discussed in the [TD Partitioning Spec].

11.9.5. Pending Virtual Interrupt Delivery Indication

The host VMM can detect whether a virtual interrupt is pending delivery to a VCPU in the Virtual APIC page, using TDH.VP.RD to read the VCPU_STATE_DETAILS TDVPS field.

The typical use case is when the guest TD VCPU indicates to the host VMM, using TDG.VP.VMCALL, that it has no work to do and can be halted. The guest TD is expected to pass an “interrupt blocked” flag. The guest TD is expected to set this flag to 0 if and only if RFLAGS.IF is 1 or the TDCALL instruction that invokes TDG.VP.VMCALL immediately follows an STI instruction. If the “interrupt blocked” flag is 0, the host VMM can determine whether to re-schedule the guest TD VCPU based on VCPU_STATE_DETAILS.

For further details, see the TDVPS definition in the [TDX Module ABI Spec].

11.9.6. Cross-TD-VCPU IPI

To perform a cross-VCPU IPI, the guest TD ILP should request an operation from the host VMM using TDG.VP.VMCALL. The VMM would then inject the requested virtual interrupt into the guest TD’s RLPs using the posted interrupt mechanism, as described in 11.9.4 above. This is an untrusted operation; thus, the TD needs to track its completion.

11.9.7. Virtual NMI Injection

The host VMM can request the Intel TDX module to inject a virtual NMI into a guest TD VCPU using the TDH.VP.WR function, by setting the PEND_NMI TDVPS field to 1. This can be done only when the VCPU is not active (a VCPU can be associated with at most one LP). Following that, the host VMM can call TDH.VP.ENTER to run the VCPU; the Intel TDX module will attempt to inject the NMI as soon as possible.

The host VMM can use TDH.VP.RD to read PEND_NMI and get the status of virtual NMI injection. A value of 0 indicates that virtual NMI has been injected into the guest TD VCPU. The host VMM also may choose to clear PEND_NMI before it is injected.

11.10. Virtualization Exception (#VE)

Intel SDM, Vol. 3, 24.9.4 Information for VM Exits Due to Instruction Execution
 Intel SDM, Vol. 3, 25.5.6 Virtualization Exceptions
 Intel SDM, Vol. 3, 27.2.5 Information for VM Exits Due to Instruction Execution

The Intel TDX module extends the VMX architectural definition of #VE. It injects #VE into the guest TD in multiple cases where an operation is not allowed by TDX, but an architectural exception (e.g., #GP(0)) is not applicable. Such cases include disallowed instruction executions, disallowed MSR accesses, many CPUID leaves, etc.

The intended usage is for the TDX-enlightened guest TD OS to have a #VE handler. By analyzing the #VE information, the handler would be able to emulate the requested operation for non-enlightened parts of the guest TD – e.g., drivers and applications.

11.10.1. Virtualization Exception Information

The **virtualization-exception information area** (VE_INFO) is maintained as part of TDVPS. It is not intended to be directly accessible by the guest TD. Instead, the #VE information can be retrieved using the **TDG.VP.VEINFO.GET** function (see the [TDX Module ABI Spec]). This is a simple way to help ensure the availability and privacy of this area.

Table 11.9: Virtualization Exception Information Area (VE_INFO), based on [Intel SDM, Vol. 3, Table 24-1]

Section	Field	Offset (Bytes)	Size (Bytes)	Description
Architectural	EXIT_REASON	0	4	The value that would have been saved into the VMCS as an exit reason if a VM exit had occurred instead of the virtualization exception.

Section	Field	Offset (Bytes)	Size (Bytes)	Description
	VALID	4	4	0 indicates that VE_INFO has no valid contents. The CPU and the Intel TDX module will not update VE_INFO if VALID is not 0. After updating VE_INFO, the CPU and the Intel TDX module write 0xFFFFFFFF to the VALID field.
	EXIT_QUALIFICATION	8	8	The value that would have been saved into the VMCS as an exit qualification if a VM exit had occurred instead of the virtualization exception.
	GLA	16	8	The value that would have been saved into the VMCS as a guest-linear address if a VM exit had occurred instead of the virtualization exception.
	GPA	24	8	The value that would have been saved into the VMCS as a guest-physical address if a VM exit had occurred instead of the virtualization exception.
	EPTP_INDEX	32	2	The current value of the EPTP index VM-execution control
Non-Architectural (EXIT_REASON is not EPT Violation)	INSTRUCTION_LENGTH	Non-arch.	4	The 32-bit value that would have been saved into the VMCS as VM-exit instruction length if a legacy VM exit had occurred instead of the virtualization exception.
	INSTRUCTION_INFORMATION	Non-arch.	4	The 32-bit value that would have been saved into the VMCS as VM-exit instruction information if a legacy VM exit had occurred instead of the virtualization exception.

The architectural section format for VE_INFO is as defined in the [Intel SDM], and it is used directly by the CPU when it injects a #VE (see 11.10.2 below). VE_INFO can also be used for #VE injected by the Intel TDX module. Some VE_INFO fields are applicable only for some exit reasons.

- 5 VE_INFO's non-architectural section is only applicable for TDX-extended #VE (injected by the TDX module), where EXIT_REASON is not EPT violation (48). It should be ignored for EPT violations converted by the CPU to #VE. See below for details.

VE_INFO.VALID is initialized to 0, and it is set to 0xFFFFFFFF when a #VE is injected to the guest TD. When handling a #VE, the guest TD retrieves the #VE information using the **TDG.VP.VEINFO.GET** function (see the [TDX Module ABI Spec]).

10 TDG.VP.VEINFO.GET checks that VE_INFO.VALID is 0xFFFFFFFF. After reading the information, it sets VE_INFO.VALID to 0.

11.10.2. #VE Injection by the CPU due to EPT Violations

EPT Violation mutation to #VE is enabled unconditionally for SEAM non-root operation. The Intel TDX module sets the TD VMCS **EPT-violation #VE** VM-execution control to 1.

- 15 For shared memory accesses (i.e., when GPA.SHARED == 1), as with legacy VMX, the VMM can choose which pages are eligible for #VE mutation based on the value of the Shared EPTE bit 63.

For private memory accesses (GPA.SHARED == 0), an EPT Violation causes a TD Exit in most cases, except when the Secure EPT entry state is PENDING (an exception to this is described in 11.11.1 below). If ATTRIBUTES.SEPT_VE_DISABLE is 0, the Intel TDX module sets the Secure EPT entry's Suppress VE bit (63) to 0 if the entry's state is PENDING. It sets that bit

20 to 1 for all other entry states.

11.10.3. #VE Injected by the Intel TDX Module

#VE may be injected by the Intel TDX module in several cases:

- Emulation of the architectural #VE injection on EPT violation, done by a guest-side Intel TDX module flow that performs an EPT walk.
- As a result of guest TD execution of a disallowed instruction (see 11.4 above), a disallowed MSR access (see 11.7 above), or CPUID virtualization (see 11.8 above).
- A notification to the guest TD about anomalous behavior (e.g., too many EPT violations reported on the same TD VCPU instruction without making progress). This kind of #VE is raised only if the guest TD enabled the specific notification (using TDG.VM.WR to write the TDCS.NOTIFY_ENABLES field) and when a #VE can be injected. See 17.3 for details.

If, when attempting to inject a #VE, the Intel TDX module discovers that the guest TD has not yet retrieved the information for a previous #VE (i.e., VE_INFO.VALID is not 0), the TDX module injects a #DF into the guest TD to indicate a #VE overrun.

11.11. Secure and Shared Extended Page Tables (EPTs)

EPT is enabled in SEAM non-root mode. SEAM non-root mode uses two EPTs: Secure EPT and Shared EPT.

EPT level is the same for both Secure and Shared EPT. If the guest TD's GPA width is greater than 48 bits (TDCS.GPAW is 1), then 5-level EPT trees are used. Otherwise, 4-level EPT trees can be used.

For further Secure EPT details, refer to Chapter 9.

EPT violations and misconfigurations generally cause a TD Exit, except for the cases described below.

11.11.1. GPAW-Related EPT Violations

GPA bits higher than the SHARED bit are considered reserved and must be 0. Address translation with any of the reserved bits set to 1 cause a #PF with PFEC (Page Fault Error Code) RSVD bit set.

11.11.2. EPT Violation Mutated into #VE

An EPT violation is converted into #VE in the following cases:

- For Secure EPT, if the EPT entry state is PENDING.
- For Shared EPT, if the EPT entry has been configured by host VMM deliver EPT violations to the guest TD as #VE exceptions for usages such as MMIO, as described in 11.10 above.

11.12. Prevention of TD-Induced Denial of Service

VMs, including TDs, can exploit Intel ISA characteristics to cause performance and functional Denial of Service (DOS) to the VMM. The Intel architecture has several mechanisms that help prevent such DOS cases. This section describes how those mechanisms are used in the context of TDX.

11.12.1. Bus Lock Detection by the TD OS

The guest TD OS can enable debug exception traps due to bus locks by setting IA32_DEBUGCTL.BUS_LOCK_DETECT bit (2), which is disabled by default. When enabled, the feature works identically to how it functions in legacy VMX non-root mode or in non-VMX mode. The IA32_DEBUGCTL MSR and DR6 are part of the state that is saved and restored on VM exit and VM entry, respectively. If the delivery of #DB was pre-empted by a trap-like VM exit, then the pending debug exceptions (including due to BUS_LOCK_DETECT if pending) are saved in TD VMCS and restored on subsequent VM Entry. For fault-like VM Exit due to conditions such as EPT violation and EPT misconfiguration that are encountered during execution of an instruction, there is no pending debug exception recorded, including the bus lock debug exception.

11.12.2. Impact of MSR_TEST_CTRL (MSR 0x33)

The host VMM can set bits in MSR_TEST_CTRL (MSR 0x33) to cause exceptions in VMs (including TDs) in case of bus locks:

- Bit 28 (UC_LOCK_DISABLE): If set to 1, a UC load lock will trigger a #GP(0) fault.
- Bit 29 (SPLIT_LOCK_DISABLE): If set to 1, a split lock will trigger an #AC fault.

MSR 0x33 is not virtualizable; it is a core-scope MSR and may be modified by the host VMM on one SMT thread while another SMT thread is running a TD VCPU. The TDX module does not allow a guest TD to access this MSR (a #VE is generated).

To avoid any security issues, **a correctly written TD OS should always be ready to handle #AC and #GP(0) faults** if the TD software might cause UC locks or split locks.

11.12.3. Bus Lock TD Exit

Bus lock TD exit is disabled by default. The host VMM can enable the TD VMCS “bus-lock detection” VM execution control using the TDH.VP.WR function.

Bus Lock VM Exit Reason (74)

If “bus-lock detection” is enabled, then if the processor detects that one or more bus locks were caused by the instruction that was executed, then the processor generates a bus lock VM exit (exit reason 74). This VM exit is trap-like, i.e., it is delivered following the execution of that instruction that caused it. The Intel TDX module then completes a TD exit with the exit information provided in the VM exit.

Bus Lock Detected Bit (26) in VM Exit Reason

If delivery of bus lock VM exit was pre-empted by a higher priority VM exit (e.g., EPT Misconfiguration, EPT Violation, etc.), then the processor sets a “bus lock detected” notification bit (bit 26) in the exit reason. The Intel TDX module reflects this bit to the host VMM on TD exit.

11.12.4. Notification TD Exit

Notification TD exit is disabled by default. The host VMM can write the TD VMCS “notify window” and “notification exiting” execution controls using the TDH.VP.WR function. If enabled and configured, then if the processor detects a no-commit case, the processor causes a notification VM exit (exit reason 75) which the Intel TDX module converts to the TD exit.

The conditions that cause a notification TD exit are the same as those in legacy VMX non-root mode. An example of such a case is the nested #AC exception. If an #AC exception occurs during the delivery of a previous #AC exception, then the CPU may get into an endless loop of #AC without responding to external events.

Bit 0 (VM context invalid) of the exit qualification indicates whether the guest TD context is corrupted and not valid in the TD VMCS. If this bit is set to 1, then it is a non-recoverable situation; thus, the Intel TDX module marks the TD as disabled to help prevent further TD entry. If no TD context corruption occurred (exit qualification bit 0 is cleared to 0), then the TD may be resumed normally.

11.13. Time Stamp Counter (TSC)

Intel SDM, Vol. 3, 10.5.4.1 TSC-Deadline Mode
 Intel SDM, Vol. 3, 24.6.5 Time-Stamp Counter Offset and Multiplier
 Intel SDM, Vol. 3, 25.3 Changes to Instruction Behavior in VMX Non-Root Operation

11.13.1. TSC Virtualization

For virtual time stamp counter (TSC) values read by guest TDs, the Intel TDX module is designed to achieve the following:

- Virtual TSC values are consistent among all the TD’s VCPUs at the level supported by the CPU, see below.
- The virtual TSC value for any single VCPU is monotonously incrementing (except roll over from $2^{64}-1$ to 0).
- The virtual TSC frequency is determined by TD configuration.

The host VMM is required to do the following:

- Set up the same IA32_TSC_ADJUST values on all LPs before initializing the Intel TDX module.
- Make sure IA32_TSC_ADJUST is not modified from its initial value before calling SEAMCALL.

The Intel TDX module checks the above as part of TDH.VP.ENTER and any other SEAMCALL leaf function that reads TSC.

The virtualized TSC is designed to have the following characteristics:

- The virtual TSC frequency is specified by the host VMM as an input to TDH.MNG.INIT in units of 25MHz – it can be between 4 and 400 (corresponding to a range of 100MHz to 10GHz).

- The virtual TSC starts counting from 0 at TDH.MNG.INIT time.
- TSC parameters are enumerated to the guest TD by CPUID(0x15).
- Guest TDs are not allowed to modify the TSC. WRMSR attempts of IA32_TIME_STAMP_COUNTER result in a #VE.
- Guest TDs are not allowed to access IA32_TSC_ADJUST because its value is meaningless to them. WRMSR or RDMSR attempts result in a #VE.
- RDTSCP is supported. This instruction returns the contents of the IA32_TSC_AUX MSR in RCX. the Intel TDX module allows the guest TD to access that MSR and context-switches it on TD entry and exit as part of the VCPU state in TDVPS.

11.13.2. TSC Deadline

Guest TDs are not allowed to access the IA32_TSC_DEADLINE MSR directly. Virtualization of IA32_TSC_DEADLINE depends on the virtual value of CPUID(1).EXC[24] bit (TSC Deadline). The host VMM may configure (as an input to TDH.MNG.INIT) virtual CPUID(1).EXC[24] to be a constant 0 or allow it to be 1 if the CPU's native value is 1.

- If the virtual value of CPUID(1).EXC[24] is 0, IA32_TSC_DEADLINE is virtualized as non-existent. WRMSR or RDMSR attempts result in a #GP(0).
- If the virtual value of CPUID(1).EXC[24] is 1, WRMSR or RDMSR attempts result in a #VE. This enables the TD's #VE handler to para-virtualize the TSC deadline functionality, e.g., by requesting an (untrusted) service from the host VMM.

11.14. Supervisor Protection Keys (PKS)

By design, guest TD usage of Supervisor Protection Keys (PKS) is controlled by the ATTRIBUTES.PKS bit (see the [TDX Module ABI Spec]). When PKS is supported by the CPU and ATTRIBUTES.PKS is set to 1, the following features are available to the guest TD:

- CPUID virtualization enumerates PKS availability to the guest TD.
- Guest TDs may enable PKS by setting CR4.PKS flag.
- Guest TDs may access the PKS state using the IA32_PKRS MSR.

11.15. Intel® Total Memory Encryption (Intel® TME) and Multi-Key Total Memory Encryption (MKTME)

Guest TDs may not directly use the Intel TME and MKTME MSRs and the PCONFIG instruction. The Intel TDX module supports para-virtualization of this ISA, as described below.

11.15.1. TME Virtualization

TME is enumerated by CPUID(0x7, 0x0).ECX[13]. The host VMM can configure the virtualization of this bit as enabled or disabled on TDH.MNG.INIT. If enabled, then a guest TD access to the IA32_TME_* MSRs (0x981 – 0x984) causes a #VE, allowing the guest TD's #VE handler to emulate the desired operation. Else, guest TD access to those MSRs causes a #GP(0).

11.15.2. MKTME Virtualization

MKTME is enumerated by CPUID(0x7, 0x0).EDX[18]. The host VMM can configure the virtualization of this bit as enabled or disabled on TDH.MNG.INIT. If enabled, then the following operations cause a #VE (e.g., the guest TD #VE handler can then communicate with the host VMM over TDG.VP.VMCALL to request the desired operation):

- Guest TD access to the IA32_MKTME_PARTITIONING MSR (0x87)
- PCONFIG execution by the guest TD

If the host VMM configured CPUID(0x7, 0x0).EDX[18] virtualized value as 0, then:

- Guest TD access to the IA32_MKTME_PARTITIONING MSR (0x87) causes a #GP(0).
- PCONFIG execution by the guest TD causes a #UD.

11.16. Virtualization of Machine Check Capabilities and Controls

Although the guest TD is not allowed to handle machine check event, the following virtualization is used in order to allow possible pare-virtualization behavior, e.g., future handling of MCE by the TD.

- The values of CPUID(1).EDX[7] (MCE) and CPUID(1).EDX[14] (MCA), as seen by the guest TD, are 1.
- The value of CR4[6] (MCE), as seen by the guest TD, is 1. Guest TD attempt to set this bit to 0 results in a #VE.
- Guest TD accesses to MSRs 0x179 (IA32_MCG_CAP), MSRs 0x17A, 0x17B, 0x4D0 (IA32_MCG_*), MSRs 0x281 through 0x29D (IA32_McX_CTL2) and MSRs 0x400 through 0x473 (IA32_McX_*) result in a #VE.

11.17. Transactional Synchronization Extensions (TSX)

Intel SDM, Vol. 1, 16 Programming with Intel TSX

10 The host VMM can enable TSX for a TD by configuring the following CPUID bits as enabled in the TD_PARAMS input to TDH.MNG.INIT:

- CPUID(7,0).EBX[4] (HLE)
- CPUID(7,0).EBX[11] (RTM)

15 The virtual values of the above bits, as seen by the guest TD, are the bitwise AND of the real values enumerated by the CPU and of the configuration values. To enable TSX for guest TDs, TDX requires the following conditions to be true:

- The virtual values of the HLE and the RTM bits are the same, either 0 or 1.
- The CPU supports the IA32_TSX_CTRL MSR (as enumerated by IA32_ARCH_CAPABILITIES[7]).

Note: If the real value of the HLE bit and the RTM bit are different, the host VMM must configure both virtual values as 0.

20 If TSX is enabled for the guest TD:

- IA32_TSX_CTRL is accessible by the TD.
- On TD exit, IA32_TSX_CTRL is set to 0. The host VMM is responsible for restoring this MSR to its desired value, if applicable.

If TSX is disabled for the guest TD:

- 25
- CPUID(7,0).EBX bits 4 and 11 are virtualized as 0.
 - IA32_TSX_CTRL is virtualized as non-existent: IA32_ARCH_CAPABILITIES bit 7 is virtualized as 0, and TD access results in a #GP(0).
 - If IA32_TSX_CTRL is supported by the CPU, XBEGIN instruction execution by the TD always aborts with EAX code 0.

11.18. Other Changes in SEAM Non-Root Mode

30 11.18.1. Tasking

Any task switch results in a VM exit to the Intel TDX module (this is a fixed-1 exit) which then performs a TD exit to the host VMM.

35 The VMM is expected not to reenter the TD VCPU since this case is non-recoverable; the instruction that caused the task switch (CALL, JMP or IRET) will re-execute and cause another VM exit. If the task switch was incidental to an exception delivery, then the VM entry following TDH.VP.ENTER will reattempt the delivery and cause another task switch VM exit. The expected response from the VMM is to terminate this TD.

11.18.2. PAUSE-Loop Exiting

Intel SDM, Vol. 3, 25.1.3 Instructions That Cause VM Exits Conditionally

40 The host VMM can only set the guest TD's "PAUSE-loop exiting" VM-execution control if the guest TD runs in debug mode (ATTRIBUTES.DEBUG is 1).

"PAUSE-loop exiting" allows the VMM to request an exit if the guest (in ring 0) executes PAUSE in a loop (e.g., busy-wait). This is intended to help avoid cases where a guest thread loops, waiting for another thread that is not currently scheduled

by the VMM. However, modern enlightened guests use a VMM-provided service (hypercall) instead of PAUSE loops – this is the expected usage for Intel TDX.

DRAFT

12. Measurement and Attestation

12.1. TD Measurement

TDs have two types of measurement registers:

- **MRTD** helps provide static measurement of the TD build process and the initial contents of the TD.
- **RTMR** is an array of general-purpose measurement registers made available to the TD software to enable measuring additional logic and data loaded into the TD at run-time.

All TD measurements are reflected in TD attestations.

12.1.1. MRTD: Build-Time Measurement Register

The Intel TDX module measures the TD during the build process. The measurement register TDCS.MRTD is a SHA384 digest of the build process, designed as follows:

- TDH.MNG.INIT begins the process by initializing the digest.
- TDH.MEM.PAGE.ADD adds a TD private page to the TD and inserts its properties (GPA) into the MRTD digest calculation.
- Control structure pages (TDR, TDCX and TDVPR) and Secure EPT pages are not measured.
- For pages whose data contribute to the TD, that data should be included in the TD measurement via TDH.MR.EXTEND. TDH.MR.EXTEND inserts the data contained in those pages and its GPA, in 256-byte chunks, into the digest calculation. If a page will be wiped and initialized by TD code, the loader may opt not to measure the initial contents of the page with TDH.MR.EXTEND.
- The measurement is then completed by TDH.MR.FINALIZE. Once completed, further TDH.MEM.PAGE.ADDs or TDEXTENDs will fail.

MRTD extension by GPA uses a 128B buffer which includes the GPA and the leaf function name for uniqueness.

12.1.2. RTMR: Run-Time Measurement Registers

The RTMR array is initialized to zero on build, and it can be extended at run-time by the guest TD using the TDCALL(TDG.MR.RTMR.EXTEND) leaf. The syntax of the RTMR registers is designed to be similar to that of TPM PCRs, where a register's value after TDG.MR.RTMR.EXTEND(index=i, value=x) is:

```
RTMR[i] = SHA384(RTMR[i] || x);
```

Four RTMR registers are provided.

Typical expected usage is for TPM emulation during guest TD OS secure boot by the VBIOS.

12.2. **UPDATED:** TD Measurement Reporting

TD attestation is initiated from inside the TD by calling TDG.MR.REPORT and specifying a REPORTDATA value. TDG.MR.REPORT creates a TDREPORT_STRUCT structure containing the TD measurements, initial configuration of the TD that was locked at finalization (TDH.MR.FINALIZE), the Intel TDX module measurements, and the REPORTDATA value. TDREPORT_STRUCT structure and TDG.MR.REPORT are detailed in the [TDX Module ABI Spec].

TDREPORT_STRUCT is HMAC'ed using an HMAC key that is designed to be accessible only to the CPU. This helps protect the integrity of the structure and, by design, can only be verified on the local platform via the **TDG.MR.VERIFYREPORT interface function** or the SGX ENCLU(EVERIFYREPORT2) instruction. By design, TDREPORT_STRUCT cannot be verified off platform; it first must be converted into signed Quotes, as described in 12.4 below.

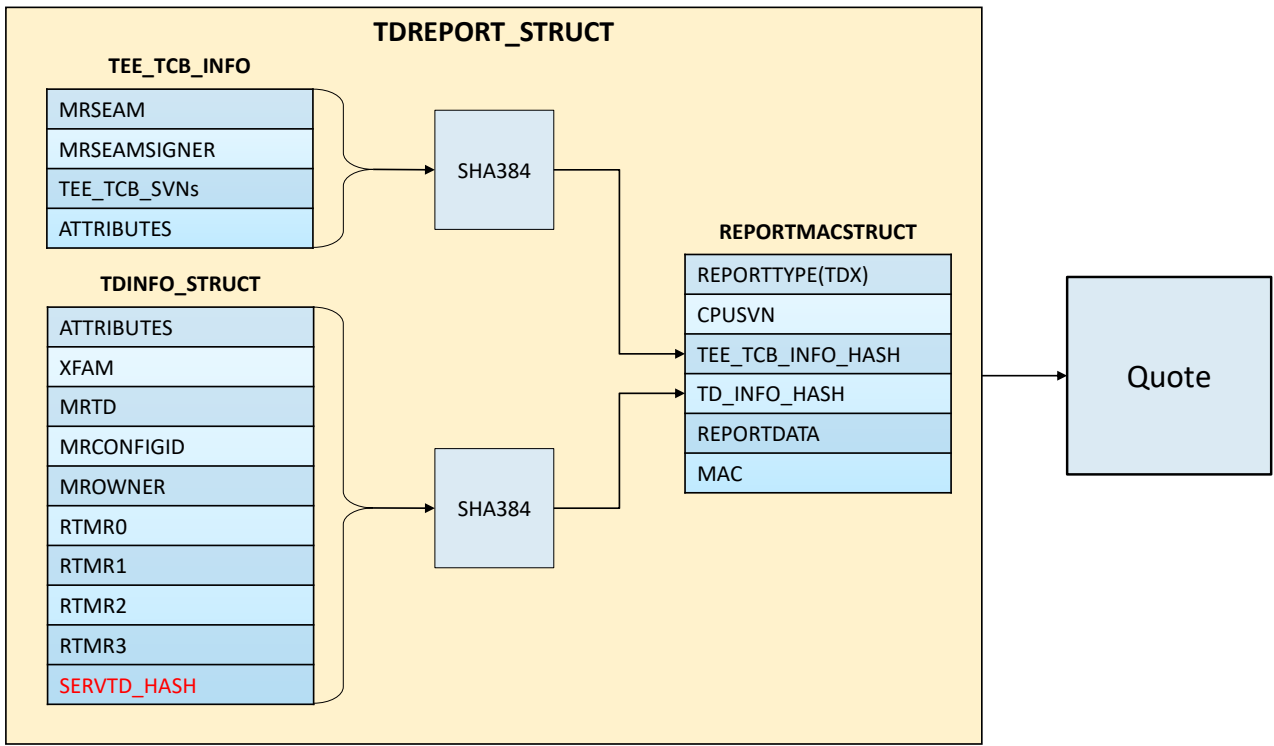

Figure 12.1: **UPDATED:** TD Measurement Reporting

The REPORTTYPE field of REPORTMACSTRUCT indicates that this is a TDX report (TYPE == 0x81) and whether SERVTD_HASH contains a valid hash of service TDs (VERSION == 1) or 0 (VERSION == 0). For details, see Ch. 13 and the [ABI Spec].

12.3. Local Report Verification

A TD can verify a report generated by another TD on the same platform using the TDG.MR.VERIFYREPORT interface function. Internally, TDG.MR.VERIFYREPORT executes the SEAMVERIFYREPORT instruction, which uses the same HMAC key, accessible only to the CPU, that was used for generating TDREPORT_STRUCT.

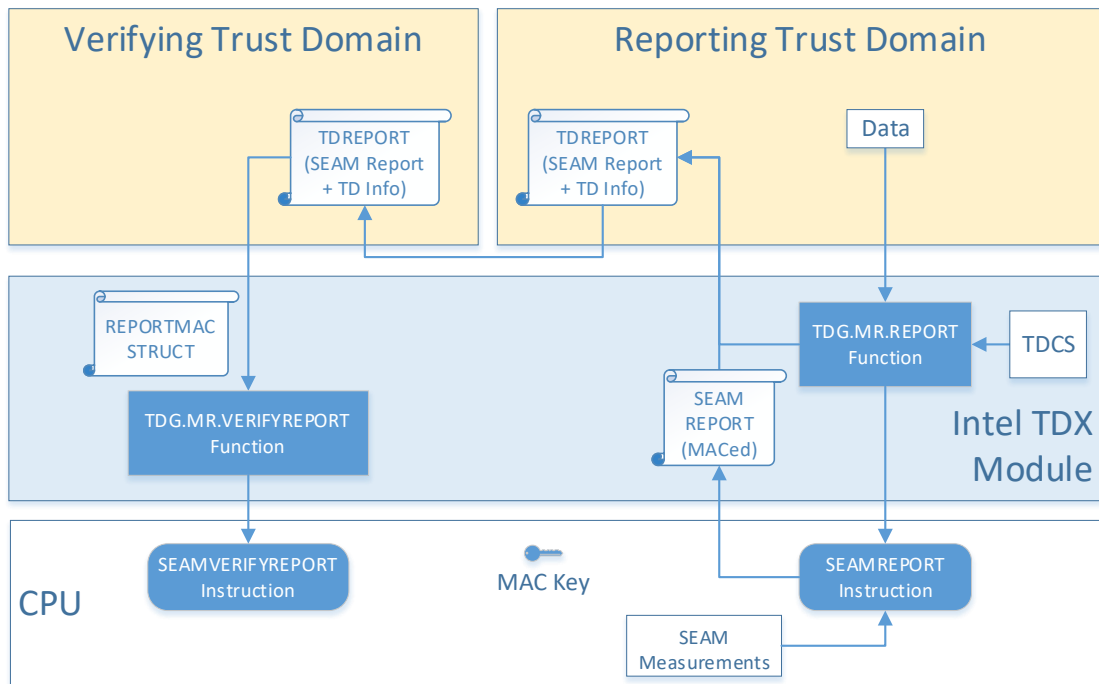

Figure 12.2: High-Level View of Local Report Verification

12.4. TD Measurement Quoting

To create a remotely verifiable attestation, the TDREPORT_STRUCT should be converted into a Quote signed by a certified Quote signing key.

12.4.1. Intel SGX-Based Attestation

- 5 The Intel SGX attestation architecture is designed to provide facilities for multiple Quoting Enclaves from multiple providers. This is intended to allow the host to instantiate a Quoting Enclave for Intel SGX attestations and another Quoting Enclave for TD attestation without interference — i.e., each provider can supply its own quoting enclave, and the quoting enclave for Intel SGX and for Intel TDX may be separate; the design does not require the quoting enclave to run inside the TD.

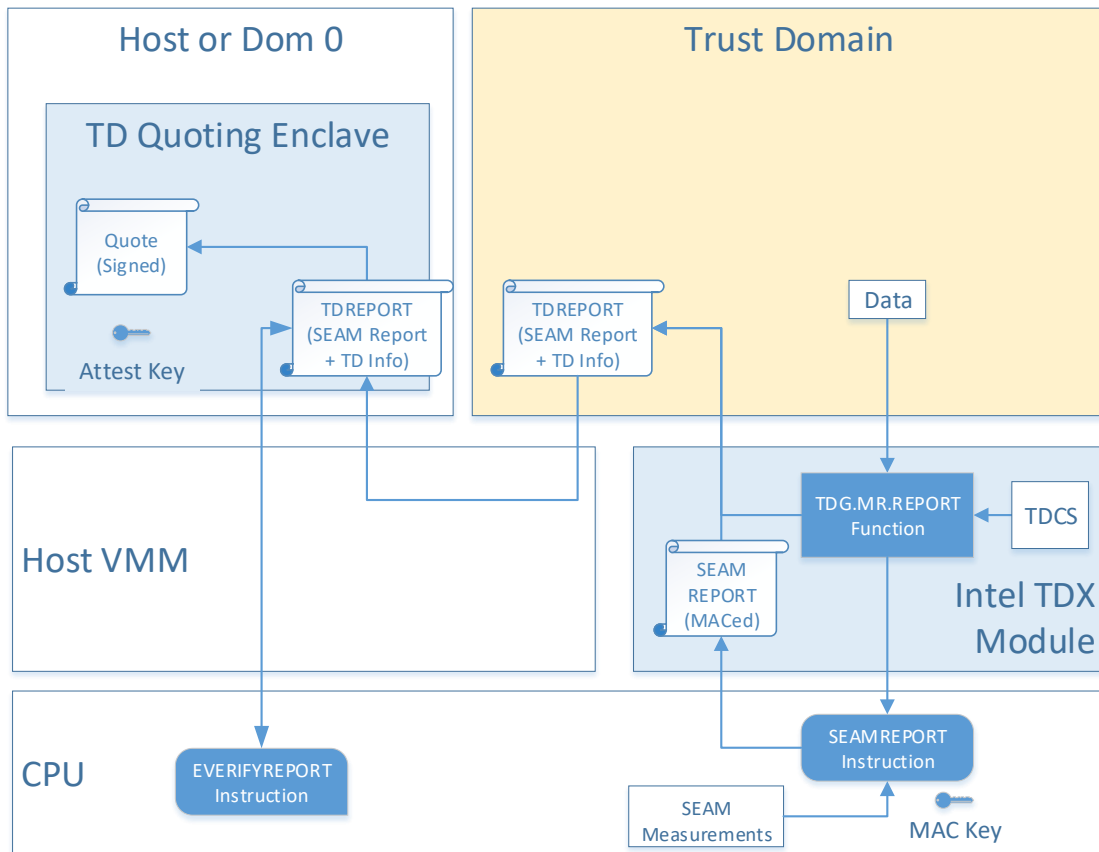

Figure 12.3: High-Level View of the Intel SGX-Based TD Attestation

Quote generation using a quoting enclave is typically performed as follows:

1. Guest TD invokes the TDCALL(TDG.MR.REPORT) function.
2. If the CPU supports TD-Preserving, the TDX module uses the SEAMOPS(SEAMDB_REPORT) instruction to create MAC'ed TDREPORT_STRUCT with the Intel TDX module measurements from CPU and TD measurements from TDCS. Else, the TDX module uses the SEAMOPS(SEAMREPORT) instruction for the same purpose.
3. Guest TD uses TDCALL(TDG.VP.VMCALL) to request that TDREPORT_STRUCT be converted into Quote.
4. The TD Quoting enclave uses EVERIFYREPORT2 to check the TDREPORT_STRUCT. This allows the Quoting Enclave to check the report without requiring direct access to the CPU's HMAC key. Once the integrity of the TDREPORT_STRUCT has been verified, the TD Quoting Enclave signs the TDREPORT_STRUCT body with an ECDSA 384 signing key.

12.5. Quote Signing Key

The Intel SGX infrastructure provides primitives and a certificate infrastructure to allow Quoting Enclaves to certify their own Quoting Keys. The Intel SGX Provisioning Certification Enclave (PCE) uses an Intel-Certified ECDSA-256 signing key to issue certificates to Quoting Enclaves for their attestation keys. Intel offers a service to allow third parties to download these certificates.

Typically, on first launch, the TD Quoting Enclave generates a random ECDSA 384-bit quoting key. It then contacts the Provisioning Certification Enclave which uses its signing key to sign the new quoting key's public key.

Note that the TD Quoting Enclave uses an ECDSA 384 bit key, while the PCE certifies it with an ECDSA-256 key. This is due to limitations of the SPR platform.

5 **12.6. TCB Recovery**

The Intel TDX architecture has several levels of TCB:

- CPU HW level, which includes microcode patch, ACMs and PFAT
- Intel TDX module software
- Attestation Enclaves which include the TD Quoting Enclave and Provisioning Certification Enclave

10 The TCB Recovery story is different for each level. The existing SGX TCB Recovery model for CPU level items applies in the same way with TDX and SGX. The model requires a restart of the platform to take effect. The Intel TDX module can be unloaded and reloaded to reflect an upgraded Intel TDX module. The enclaves can be upgraded at run-time, but if the PCE is upgraded, the design requires a new certificate to be downloaded.

DRAFT

13.NEW: Service TDs

13.1. Overview

One or more **service TDs** may be bound to a **target TD**. Service TD binding relationship has the following characteristics:

- A service TD has a **type** (SERVTD_TYPE).
- A service TD may **read and/or write certain target TD metadata**. Access permission to target TD metadata fields depends on SERVTD_TYPE.
- **Unsolicited service TD binding** is done without target TD approval. The target TD needs not be aware of the binding.
- The target TD’s TDREPORT indicates binding to service TDs.
- The service TD protocol consists of:
 - Binding
 - Metadata access
- Service TD to target TD binding relationship is many-to-many
 - Multiple service TDs of different types may be bound to a single target TD.
 - Multiple target TDs may be bound to a single service TD.
- A service TD may itself be a target TD to other service TDs.

Typical Unsolicited Service TD Binding and Metadata Access Use Case

1. **Optional Pre-Binding:** During target TD build, before calling TDH.MR.FINALIZE, the host VMM calls TDH.SERVTD.PREBIND to write the binding fields (SERVTD_HASH etc.) in the target TD’s service TD table.
2. **Binding:** Sometime later, the host VMM calls TDH.SERVTD.BIND to bind the service TD. It gets back a binding handle. The VMM communicates the binding handle, target TD_UUID and other binding parameters to the service TD.
3. **Metadata Access:** The service TD uses TDG.SERVTD.RD/WR* to access target TD metadata.
4. **Rebinding:** May be required due to, e.g., both target TD and service TD have been migrated or a new service TD instance replaces the original one. The host VMM calls TDH.SERVTD.BIND to rebind the service TD. It gets back a binding handle. The VMM communicates the binding handle, target TD_UUID and other binding parameters to the service TD.

13.2. Service TD Binding

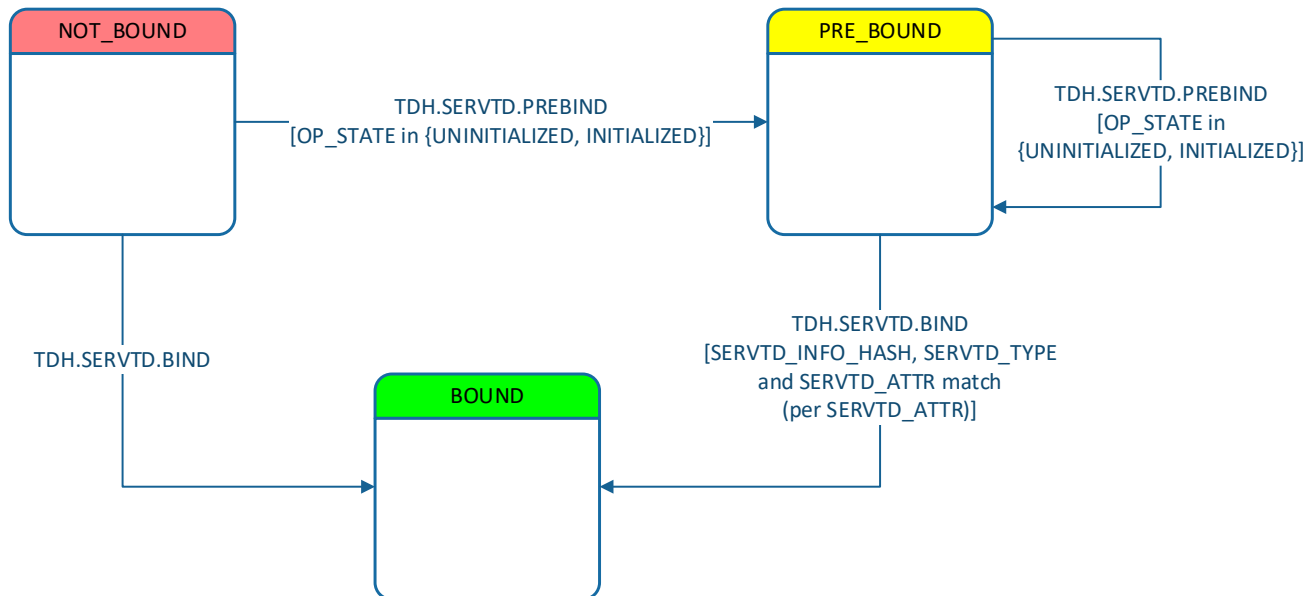

Figure 13.1: Service TD Binding State Machine

13.2.1. Service TD Binding Table in the Target TD’s TDCS

The target TD’s TDCS holds a service TD binding table. Each row (binding slot) in the table contains the following fields, which are detailed in the following sections:

- SERVTD_BINDING_STATE

- SERVTD_INFO_HASH
- SERVTD_TYPE
- SERVTD_ATTR
- SERVTD_UUID

5 The available number of slots in the table is enumerated by TDH.SYS.RD*.

13.2.2. SERVTD_BINDING_STATE: Service TD Binding State

SERVTD_BINDING_STATE indicates the state of the service TD binding slot. It has the following values:

Table 13.1: SERVTD_BINDING_STATE Definition

Value	Name	Meaning
0	NOT_BOUND	No service TD is bound. The binding fields in this slot are N/A.
1	PRE_BOUND	No service TD is bound. SERVTD_INFO_HASH, SERVTD_TYPE and SERVTD_ATTR have been set. They will be included in SERVTD_HASH calculation and be checked on any following binding.
2	BOUND	A service TD is bound. SERVTD_UUID, SERVTD_INFO_HASH, SERVTD_TYPE and SERVTD_ATTR have been set and be checked on any following binding. SERVTD_INFO_HASH, SERVTD_TYPE will be included in SERVTD_HASH calculation and be checked on any following binding.

10 13.2.3. SERVTD_TYPE: Service TD Binding Type

A service TD implements one or more SERVTD_TYPES. A specific SERVTD_TYPE is specified per binding; the same service TD may be bound multiple times if it implements more than one SERVTD_TYPE.

SERVTD_TYPE controls the following:

- The target TD metadata fields that the service TD may read and/or write.
- Whether or not multiple bindings of this SERVTD_TYPE can exist at the same time for a specific target TD.

SERVTD_TYPE values supported by the TDX module are defined in the [TDX Module ABI Spec].

13.2.4. SERVTD_ATTR: Service TD Binding Attributes

SERVTD_ATTR is a set of service TD binding attributes. It includes the following fields:

Unsolicited Binding (SOLICITED_BINDING == 0)

20 With **unsolicited binding**, service TD binding is done without target TD awareness, but is reflected in the target TD's TDREPORT.

13.2.4.1. INSTANCE_BINDING: Class vs. Instance Binding

Specifies whether a specific Service TD instance or a class of a service TD is bound.

Class Binding (INSTANCE_BINDING == 0)

25 With **class binding**, rebinding can be done with any TD with the same SERVTD_INFO_HASH (unless PLATFORM_BINDING is 1), SERVTD_TYPE and SERVTD_ATTR as the original binding. Those parameters are migrated when the target TD is migrated.

Instance Binding (INSTANCE_BINDING == 1)

30 With **instance binding**, rebinding can be done with the same TD instance (same SERVTD_UUID), using the same SERVTD_TYPE and SERVTD_ATTR as the original binding. SERVTD_INFO_HASH is not checked; instead, it is updated. This allows the service TD instance to be migrated together with the target TD; the service TD may itself bind with a different Migration TD at the destination.

13.2.4.2. MIGRATABLE_BINDING: Binding Migratability

Specifies whether a service TD binding can be migrated.

Non-Migratable Binding (MIGRATABLE_BINDING == 0)

With non-migratable binding, only some of the binding state of the service TD is migrated. A different service TD may be bound at the destination platform, subject to the conditions described below.

SERVTD_BINDING_STATE, SERVTD_TYPE and SERVTD_ATTR are exported as part of the TD’s mutable state.

When importing the target TD’s mutable state to the destination platform:

1. If the imported SERVTD_BINDING_STATE is NOT_BOUND, then the other imported service TD fields (SERVTD_TYPE, SERVTD_TYPE and SERVTD_ATTR) are ignored.
2. Else (imported SERVTD_BINDING_STATE is PRE_BOUND or BOUND):
 - 2.1. If there is already a PRE_BOUND or BOUND service TD at this binding slot, then the SERVTD_TYPE and SERVTD_ATTR must match. The other imported fields for that binding slot are ignored. If SERVTD_TYPE or SERVTD_ATTR don’t match, import fails.

Note: This is the case used for **Migration TD**.

In all cases, if the imported SERVTD_TYPE allows only a single instance of that type, no other service TD slot may have a PRE_BOUND or BOUND service TD of the same SERVTD_TYPE.

13.2.4.3. IGNORE_TDINFO: TDINFO Component Filtering

IGNORE_TDINFO is a bit array which determines which component of the service TD’s TDINFO_STRUCT field is included in the calculation of SERVTD_INFO_HASH. For details see 13.2.6 below.

13.2.5. SERVTD_UUID: Service TD Instance Identifier

TD_UUID is a 256-bit random number that serves as a universally unique identifier of a TD. TD_UUID is created by TDH.MNG.CREATE and is stored in the TD’s TDR. When a service TD is bound to a target TD, its TD_UUID is stored in the target TD’s service TD table slot’s SERVTD_UUID field.

13.2.6. Service TD’s Binding SERVTD_INFO_HASH Calculation

For the purpose of service TD binding, a SHA384 hash of the service TD’s measurable attribute is calculated in a similar way to the calculation done by TDG.MR.REPORT (see 12.2), except that filtering is applied based on the binding SERVTD_ATTR:

- The SERVTD_ATTR.IGNORE_TDINFO selects which TDINFO_STRUCT field is ignored (a value of 0 is used in the calculation).

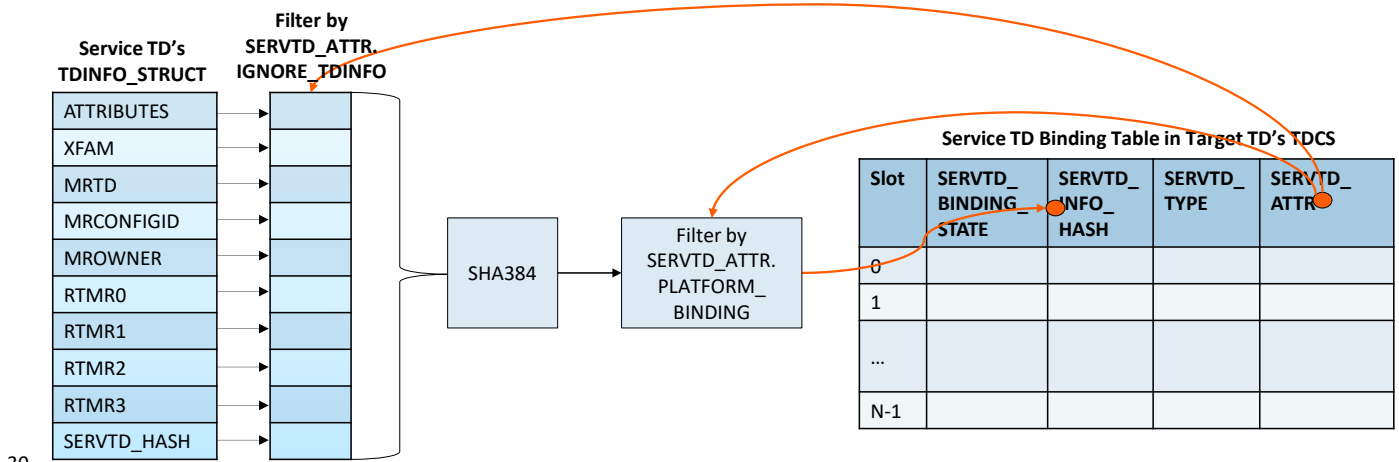

Figure 13.2: SERVTD_INFO_HASH Calculation

13.2.7. Target TD’s SERVTD_HASH Calculation

SERVTD_HASH is a single field that summarizes all the service TDs bound or pre-bound to the target TD in an unsolicited mode. SERVTD_HASH is calculated on TD build and on TD import.

13.2.7.1. *SERVTD_HASH Calculation of Finalization of TD Build*

On **TD build**, `SERVTD_HASH` is calculated by `TDH.MR.FINALIZE`. At that time, the binding information for all bound or pre-bound service TDs is known.

13.2.7.2. *SERVTD_HASH Calculation on TD Import*

- 5 On TD import, `SERVTD_HASH` is recalculated by `TDH.IMPORT.STATE.IMMUTABLE`. In case of non-migratable service TD binding, the imported binding information is checked but does not replace the existing binding information. E.g., the Migration TD bound on the source platform may have a different `INFO_HASH` than that of the Migration TD bound on the destination platform. The recalculated `SERVTD_HASH` reflects the service TDs bound on the destination platform.

- 10 The reason for this recalculation is to narrow down the TCB for the migrated TD attestation. E.g., suppose the Migration TD on either or both sides are malicious and can forge any migration information. Even in this case the target TD's attestation is based on information collected by the TDX module. It is independent on any TD and reflects the true identity of the service TDs bound to the target TD.

13.2.7.3. *SERVTD_HASH Calculation Method*

`SERVTD_HASH` is calculated as follows:

- 15 1. Get all service TD binding slots whose `SERVTD_BINDING_STATE` is not `NOT_BOUND`.
2. Sort by `SERVTD_TYPE` as the primary key, `SERVTD_INFO_HASH` as a secondary key (if multiple service TDs of the same type are bound).
3. Concatenate `SERVTD_INFO_HASH`, `SERVTD_TYPE` and `SERVTD_ATTR` of each slot
4. Concatenate all slots.
- 20 5. Calculate SHA384.

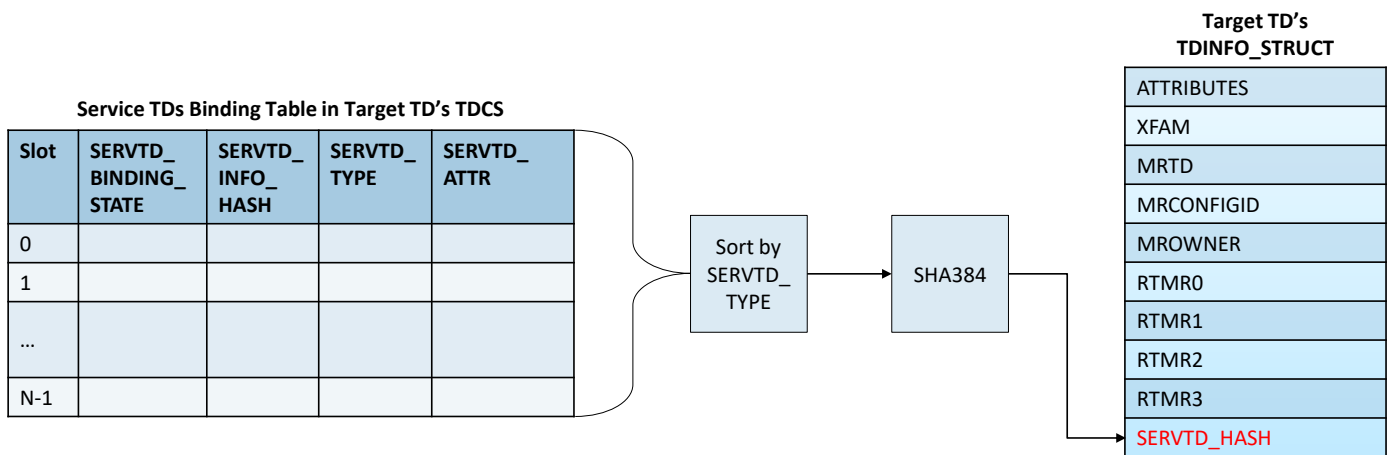

Figure 13.3: `SERVTD_HASH` Calculation

13.2.8. `TDH.SERVTD.PREBIND`: Pre-Binding a Service TD

`TDH.SERVTD.BIND` is used by the host VMM to bind a service TD. It is detailed in the [TDX Module ABI Spec].

Inputs

- 25
- Target TD's TDR HPA
 - `SERVTD_INFO_HASH`
 - `SERVTD_TYPE`
 - `SERVTD_ATTR`
- 30
- Service TD Index (slot number in the target TD's binding table)

Operation

- Check that the target TD's measurements have not been finalized (by `TDH.MR.FINALIZE`).
- Check that no service TD is already bound in the given slot number.
- Store the service TD's `SERVTD_INFO_HASH`, `SERVTD_TYPE` and `SERVTD_ATTR`.

13.2.9. TDH.SERVTD.BIND: Binding a Service TD

TDH.SERVTD.BIND is used by the host VMM to bind a service TD. It is detailed in the [TDX Module ABI Spec].

Binding Scenarios

Initial Binding: No pre-binding has been done; initial service TD binding can only be done before TDH.MR.FINALIZE of the target TD.

Late Initial Binding: Pre-binding has been done; initial service TD binding can be done at any time. SERVTD_INFO_HASH and SERVTD_ATTR must match.

Rebinding: Binding has been done; rebinding conditions depend on SERVTD_ATTR as described before.

Inputs

- Target TD's TDR HPA
- Service TD's TDR HPA – NULL_PA (-1) if pre-binding is requested
- SERVTD_TYPE
- SERVTD_ATTR
- Service TD Index (slot number in the target TD's binding table)

Outputs

- Binding Handle (described below)

Operation

- Calculate the service TD's SERVTD_INFO_HASH.
- Check binding conditions vs. the target TD's binding table.
- Store the service TD's SERVTD_INFO_HASH, SERVTD_TYPE, SERVTD_ATTR and SERVTD_UUID in the target TD's binding table.
- Calculate the binding handle as $f(\text{service TD's TD_UUID}, \text{target TD's TDR HPA}, \text{slot number})$.

13.2.10. Binding Handle

The binding handle is used as a shortcut, to quickly identify both the target TD and the binding slot. It should be noted that the target TD identity is verified by its TD_UUID; the binding handle does not replace it. The binding handle is not a secret.

The binding handle is calculated from the following variables, using a simple addition:

- Least significant 64 bits of SERVTD_UUID – this serves to obfuscate the handle, so the service TD does not use HPA or slot number directly.
- Target TD's TDR HPA (platform-specific unique identifier of the target TD)
- Target TD's binding slot number

Given the handle, the TDX module can reconstruct TDR_HPA and binding slot number.

The binding handle is platform-specific and must be recreated after migration. This may be triggered when the service TD attempts to access target TD metadata using TDG.SERVTD.RD/WR* and an error is returned.

13.3. Target TD Metadata Access by a Service TD

13.3.1. TDG.SERVTD.RD/WR: Metadata Read/Write Interface Functions

TDG.SERVTD.RD and TDG.SERVTD.WR are similar to other metadata access functions, e.g.:

- Host-side: TDH.MNG.RD/WR
- Guest-side: TDG.VM.RD/WR

Refer to 18.6 for a description of the TDX module metadata interface.

Inputs

- Target TD_UUID, uniquely identifying the target TD
- Binding handle, identifies the binding slot and a shortcut for identifying the target TD

- A single metadata field ID or metadata field list

Output

- For a single field access: Field value

Operation

1. Calculate the target TD's TDR HPA and binding slot number from the binding handle.
2. Check that the target TD_UUID is the same as specified.
 - 2.1. A special case (used by Migration TDs) is when the binding had been done on destination platform before the TD was imported. In this case the target TD_UUID is overwritten at the beginning of import, as part of the TD's immutable state import by TDH.IMPORT.STATE.IMMUTABLE. The pre-import TD_UUID is saved in the target TD's TDCS. If the specified target TD_UUID doesn't match the actual value, but matches the pre-import value, a status code is returned to the service TD, with the updated TD_UUID.
3. Get the binding parameters from the target TD's service TD table binding slot.
4. Check that the service TD's TD_UUID is equal to the target TD's bind slot's SERVTD_UUID.
5. Access the metadata (similar to other metadata access operations).

13.3.2. Metadata Access Error Handling

TDG.SERVTD.RD/WR interface functions run in the context of the service TD but access the target TD's control structures. This introduces an opportunity for the service TD to create a denial-of-service to the host VMM, which is handled as described below.

Local Errors (in the Service TD Context)

- Local errors that only impact the service TD context are normally, as in other TDCALL flows. These include, e.g., the following cases:
- Errors such as incorrect service TD state result in an error code returned to the caller service TD.
 - EPT violations when accessing the service TD's memory cause a fault-like TD exit; The VMM may resolve the situation (e.g., TDH.EXPORT.UNBLOCKW if the service TD is being live-migrated) and resume the service TD.

25 Cross-TD Errors

Cross-TD errors impact the target TD. For example, errors may happen due to target TD state, e.g., the target TD may be migrated or may be torn down. The service TD may not be aware of the target TD state when invoking the interface function.

Cross-TD errors cause a trap-like TD exit:

- 30 1. TDG.SERVTD.RD/WR* flow sets output operands (e.g., completion status returned in RAX) and advances the virtual CPU state to the next service TD guest instruction, but TD-exits immediately before resuming the guest TD.
2. The host VMM may take action to detect denial of service, e.g., the guest calling TDG.SERVTD.RD/WR* in a tight loop.
3. The host VMM may let the service TD resolve the situation by resuming it, using TDH.VP.ENTER. On TD entry, the service TD gets the status code as returned by TDG.SERVTD.RD*/WR*.

35 13.3.3. Cross-TD Concurrency Handling: Maintaining Host-Side Priority

13.3.3.1. Problem Description

Host VMM access to the target TD have a higher priority than service TD access to that target TD. This helps mitigate denial-of-service cases such as when the service TD loops on TDG.SERV.RD/WR*, locking target TD resources and preventing the host VMM from doing host-side operations that require access to such resources.

40 Applicable target TD resources are, e.g.:

- TDG.SERV.RD/WR locks the target TD's TDR in a shared mode, to help ensure that the target TD is available throughout the guest-side flow. This may interfere with critical host-side operations (e.g., disabling a TD) that require locking that target TD's TDR in an exclusive mode.
- TDG.SERV.RD/WR locks the target TD's TDCS.OP_STATE to help ensure that OP_STATE doesn't change in a way that prevents access during the guest-side flow. This may interfere with critical host-side operations (e.g., pausing a TD during export) that require locking that target TD's OP_STATE in an exclusive mode.

We currently assume that guest-side flows can only acquire locks in shared mode; thus, they only compete with the host-side flows acquiring locks in exclusive mode.

13.3.3.2. *Solution*

- 5 A new HOST_PRIORITY flag is added to shared/exclusive locks protecting resources that may be accessed by the host VMM and a guest service TD. For details, see 18.1.4.

DRAFT

14.I/O Support

This chapter specifies the Intel TDX I/O model.

14.1. Overview

Intel TDX architecture does not prescribe a specific software convention to perform I/O from the guest TD. Guest TD providers have many choices to provide I/O to the guest. The common I/O models are emulated devices, para-virtualized devices, SRIOV devices and Direct Device assignments. Guest TD providers can choose to offer the combinations of I/O models based on the workload and use case. To virtualize MMIO, the following options can be utilized:

- **Para-Virtualized Drivers** can replace MMIO accesses with TDG.VP.VMCALL to invoke VMM provided MMIO emulation functions.
- **MMIO Emulation by #VE Handlers** can use non-para-virtualized drivers in the guest TD, with the emulation performed by the #VE handler. EPT and #VE mechanisms can be used to reflect violations to the #VE handler in the guest TD on access to virtual MMIO ranges. These violations can invoke VMM-provided MMIO emulation functions through TDG.VP.VMCALL. In this model, the #VE handler is expected to emulate the faulting instruction in the guest TD.

14.2. Paravirtualized I/O

Para-virtualization (e.g., using virtio APIs in KVM, etc.) helps provide a mechanism for the guest TD to use devices on the host machine that are owned and managed by the VMM. The guest TD drivers can use the TDG.VP.VMCALL function to invoke the functions provided by the VMM to perform I/O. The TD drivers must ensure that the data buffers passed to/from functions invoked using TDG.VP.VMCALL are placed in the TD's shared memory space.

14.3. MMIO Emulation and Emulated Devices

An alternate technique that the guest TD may employ to invoke VMM functions for I/O is to emulate MMIO access from legacy device drivers. To support this use model, the VMM may enable reflection of EPT violation to emulated MMIO guest physical addresses as virtualization exceptions (#VE), as described in 11.10. A #VE exception handler in the guest TD OS can emulate the instruction causing the #VE, and as part of the emulation, it can invoke the I/O functions provided by the VMM using TDCALL(TDG.VP.VMCALL). Similar to the paravirtualized I/O model, the TD software must ensure that the data buffers passed to/from functions invoked using TDG.VP.VMCALL are placed in the TD's shared memory space.

14.4. Direct Device Assignment (DDA) and SRIOV

The VMM may assign devices directly to the guest TD. The addresses mapping the MMIO resources of such devices must be mapped in the shared memory space of the TD. When submitting data buffers to these devices, the guest TD must locate the data buffers in shared memory such that the directly assigned device can move data in/out of such buffers using DMA. The data buffers placed in shared memory should be programmed in IOMMU page tables.

The SRIOV virtual function devices assigned to guest TD also follow the DDA guidelines stated above with respect to MMIO and data buffers. The control plane of the virtual function would use the soft or hard mechanism to configure the virtual functions:

- The soft mechanism would use para-virtualization to configure the virtual function.
- The hard mechanism would use hardware mailboxes accessed using MMIO in the shared memory region.

14.5. IOMMU – DMA Remapping

The IOMMU uses the VT-d remapping tables to translate GPA in the DMA from device to an HPA. The VT-d remapping tables will reflect the mapping of memory used by I/O devices in the guest TD. The programming of the VT-d remapping tables and management will be done by the VMM.

Only shared GPA memory should be mapped in the VT-d tables:

- If the result of the translation results in a physical address with a TD private key ID, then the IOMMU will abort the transaction and report a VT-d DMA remapping failure.

- If the GPA in the transaction that is input to the IOMMU is private (SHARED bit is 0), then the IOMMU may abort the transaction and report a VT-d DMA remapping failure, even if the translated physical address is with a non-private HKID. This is intended to support debug wherein a TD or VMM could program a bad GPA into the device.

14.6. Shared Virtual Memory (SVM)

- 5 Shared Virtual Memory enables applications to access buffers directly accessed by the devices. The VT-d tables help provide the mechanism to map application buffers using the first level and second-level page tables to provide applications access to the same memory accessed by devices.

SVM should be avoided because VT-d tables can only map shared memory.

DRAFT

15. Debug and Profiling Architecture

The Intel TDX module debug architecture includes the following debug facilities:

On-TD Debug: Facilities for debugging a guest TD using software that runs inside the TD

Off-TD Debug: Facilities for debugging a guest TD, configured in debug mode, using software that runs outside the TD

15.1. On-TD Debug

Intel SDM, Vol. 3, 17 Debug, Branch Profile, TSC and Intel Resource Director Technology (Intel RDT) Features

15.1.1. Overview

On-TD debug means that the TD software is using CPU debug capabilities. A debug agent inside the guest TD can use available CPU debug features and – if needed – interact with external debug entities (e.g., a debugger running in a VM on the same platform, or a debugger running on another platform) via standard I/O interfaces. The Intel TDX module is designed to virtualize and isolate TD debug capabilities from the host VMM and software. On-TD debug can be used for production or debug TDs – i.e., regardless of the guest TD's ATTRIBUTES.DEBUG state.

Guest TDs are allowed to use almost all architectural debug features supported by the processor, e.g.:

- Single stepping
- Code, data and I/O breakpoints
- INT3
- Bus lock detection
- DR access detection
- TSX debug

However, the TDX architecture does not allow guest TDs to toggle IA32_DEBUGCTL uncore PMI enabling bit (13).

Guest TDs are allowed to use almost all architectural tracing features, e.g.:

- LBR (if allowed by the TD's XFAM, see 11.5)
- PT (if allowed by the TD's XFAM, see 11.5)
- BTS
- PEBS
- PERF_METRICS

However, the TDX architecture does not allow guest TDs to use BTM.

15.1.2. Generic Debug Handling

15.1.2.1. Context Switch

By design, the Intel TDX module context-switches all debug/tracing state that the guest TD is allowed to use.

- DR0-3, DR6 and IA32_DS_AREA MSR are context-switched in TDH.VP.ENTER and TD exit flows.
- RFLAGS, IA32_DEBUGCTL MSR and DR7 are saved and cleared on VM exits from the guest TD and restored on VM entry to the guest TD.
- Pending debug traps are natively saved on VM exits from the guest TD and reloaded on VM entries using the TD VMCS PDE field.

15.1.2.2. IA32_DEBUGCTL MSR Virtualization

Intel SDM, Vol. 3, 17.4.1 IA32_DEBUGCTL MSR

By design, IA32_DEBUGCTL access by the guest TD is restricted as follows:

- Guest TD attempts to set any of the architecturally reserved bits 63:15 and 5:2 result in a #GP(0).
- Guest TD attempts to set TDX-disallowed values result in a #VE. This includes the following cases:
 - Enable Uncore PMI by setting bit 13 to 1 (see 15.4 below).
 - Enable BTM by setting bits 7:6 to 0x1 (see details in 15.1.3 below).
- Uncore PMI is virtualized as disabled; bit 13 is read as 0 (see 15.4 below).

15.1.3. Debug Feature-Specific Handling

The following table discusses how specific debug features are handled.

Table 15.1: Debug Feature-Specific Handling

Debug Feature	How the Feature is Controlled	Handling
Hardware Breakpoints	<ul style="list-style-type: none"> DR7, DR0-3 and DR6 	No special handling: DRs are context-switched.
General Detect	<ul style="list-style-type: none"> DR7 bit 13 (GD) 	No special handling: DR7 is context-switched.
TSX Debug	<ul style="list-style-type: none"> DR7 bit 11 (RTM) IA32_DEBUGCTL bit 15 (RTM) 	No special handling: DR7 and IA32_DEBUGCTL are context-switched.
Single Stepping	<ul style="list-style-type: none"> RFLAGS bits 18 (Trap Flag) and 16 (Resume Flag) IA32_DEBUGCTL bit 1 (BTF) 	No special handling: RFLAGS and IA32_DEBUGCTL are context-switched.
Bus-Lock Detection	<ul style="list-style-type: none"> IA32_DEBUGCTL bit 2 (BUS_LOCK_DETECT) 	No special handling: IA32_DEBUGCTL is context-switched.
Software Breakpoints (INT1, INT3)	None	No special handling: software breakpoints are stateless.
Branch Trace Message (BTM)	<ul style="list-style-type: none"> IA32_DEBUGCTL bits 6 (TR) and 7 (BTS) 	<p>Not allowed: when a guest TD attempts to set IA32_DEBUGCTL[7:6] to 0x1, the Intel TDX module injects a #VE (see 15.1.2 above).</p> <p>In debug mode (ATTRIBUTES.DEBUG == 1), the host VMM is allowed to activate BTM by setting the above bits to 0x1.</p>
Branch Trace Store (BTS)	<ul style="list-style-type: none"> IA32_DEBUGCTL bits 6 (TR), 7 (BTS), 8 (BTINT), 9 (BTS_OFF_OS) and 10 (BTS_OFF_USR) 	<p>No special handling: IA32_DEBUGCTL and IA32_DS_AREA are context-switched.</p> <p>Notes:</p> <ul style="list-style-type: none"> The guest TD can configure BTS to raise PMI on buffer overflow (by setting BTINT = 1). However, since PMIs are virtualized by the host VMM, the guest TD should be ready to handle spurious, delayed and dropped PMIs. See Perfmon discussion in 15.2 below. BTS may allow the guest TD to hang the machine if BTS record generation causes a #PF or a #GP(0), because the act of getting to the exception handler may deliver another BTS. It is highly recommended that the host VMM enables notification TD exit, as described in 0.
Processor Trace (PT)	<ul style="list-style-type: none"> IA32_RTIT_CONTROL Requires VMM's consent on TD initialization by setting TD_PARAMS.XFAM[8] to 1 	PT state handling as part of the extended feature set state is discussed in 11.5.
Architectural Last Branch Records (LBRs)	<ul style="list-style-type: none"> IA32_LBR_CONTROL Requires VMM's consent on TD initialization by setting TD_PARAMS.XFAM[15] to 1 	LBR state handling as part of the extended feature set state is discussed in 11.5.
Non-Architectural LBRs	<ul style="list-style-type: none"> IA32_DEBUGCTL bit 0 (LBR) 	Guest TD attempt to set IA32_DEBUGCTL[0] is ignored by the CPU.

15.2. On-TD Performance Monitoring

Intel SDM, Vol. 3, 18 Performance Monitoring

15.2.1. Overview

The host VMM controls whether a guest TD can use the performance monitoring ISA using the TD's ATTRIBUTES.PERFMON bit – part of the TD_PARAMS input to TDH.MNG.INIT (see the [TDX Module ABI Spec]).

By design, if a guest TD is allowed to use performance monitoring, then:

- The guest TD enumerates native architectural Perfmon capabilities via CPUID leaf 0x0A.
- The guest TD is allowed to use all Perfmon ISA. This includes executing the RDPMC instruction and accessing Perfmon MSRs (see 15.2.2 below).
- Perfmon state is context-switched by the Intel TDX module across TD entry and exit transitions.

Context-switching the Perfmon state has a performance impact. TD entry and exit latencies are longer than when a guest TD is not allowed to use Perfmon.

By design, if a guest TD is not allowed to use performance monitoring, then:

- The guest TD enumerates no architectural Perfmon capabilities. CPUID leaf 0x0A returns all 0s.
- The guest TD is not allowed to use Perfmon ISA, including RDPMC.
- Perfmon state is not context-switched across TD entry and exit transitions.

Regardless of Perfmon enabling, per the design:

- IA32_DS_AREA MSR is context-switched across TD entry and exit transitions.
- Counter freeze control (IA32_DEBUGCTL bit 12) is context-switched across TD entry and exit transitions.
- The uncore PMI enable bit (IA32_DEBUGCTL bit 13) is preserved during SEAM mode execution, including Intel TDX module and guest TD execution. This bit is virtualized to the guest TD as 0, and the TD is prevented from setting it. See 15.4 below for details.

See also 15.1 above.

The Intel TDX module is designed to support the following performance monitoring capabilities:

- Architectural performance monitoring version 5, described in [Intel SDM, Vol. 3, 18.2.5]
- Exactly 8 performance monitoring counters (IA32_PMC0 through IA32_PMC7)
- Exactly 4 fixed counters (IA32_FIXED_CTR0 through IA32_FIXED_CTR3)
- Some non-architectural MSRs (see 15.2.2 below)

15.2.2. Performance Monitoring MSRs

Perfmon uses the following MSRs:

Table 15.2: Performance Monitoring MSRs

MSR	Comments	Enumeration	Reference
IA32_PMCx	multiple MSRs	CPUID(0x0A).EAX[15:8] The Intel TDX module requires the CPU to support 8 counters.	
IA32_PERFEVTSELx	multiple MSRs	CPUID(0x0A).EAX[15:8]	
MSR_OFFCORE_RSPx	2 MSRs, model-specific		
IA32_FIXED_CTRx	multiple MSRs	IA32_FIXED_CTRx is supported if (x < CPUID(0x0A).EDX[4:0]) or if (CPUID(0x0A).ECX[x] == 1). The Intel TDX module requires the CPU to support counters 0 through 3.	[Intel SDM, Vol. 3, 18.2.5.2]
IA32_PERF_METRICS		IA32_PERF_CAPABILITIES[15]	

MSR	Comments	Enumeration	Reference
IA32_PERF_CAPABILITIES			
IA32_FIXED_CTR_CTRL			
IA32_PERF_GLOBAL_STATUS			
IA32_PERF_GLOBAL_CTRL			
IA32_PERF_GLOBAL_STATUS_RESET	Command MSR – not context-switched		
IA32_PERF_GLOBAL_STATUS_SET	Command MSR – not context-switched		
IA32_PERF_GLOBAL_INUSE			
IA32_PEBS_ENABLE	model-specific		
MSR_PEBS_DATA_CFG	model-specific		
MSR_PEBS_LD_LAT	model-specific		
MSR_PEBS_FRONTEND	model-specific		
IA32_A_PMCx	multiple MSRs	CPUID(0x0A).EAX[15:8], IA32_PERF_CAPABILITIES[13] The Intel TDX module requires the CPU to support 8 counters.	[Intel SDM, Vol. 3, 18.2.6]

MSR virtualization is described in 11.7.

15.2.3. Performance Monitoring Interrupts (PMIs)

By design, when a guest TD is allowed to use Perfmon, it can also configure the counters to raise PMI on overflow. When such a TD counter overflows, the physical interrupt or an NMI configured by the host VMM into the local APIC is delivered. This interrupt or NMI causes a VM exit, and it is delivered as a TD exit to the host VMM. The host VMM is then expected to inject the PMI into the guest TD, either as a virtual interrupt using the posted interrupt mechanism (see 11.9.4), or as virtual NMI using the NMI injection interface (see 11.9.6).

Since the host VMM is not trusted, the guest TD must be ready to handle spurious, delayed or dropped PMIs. Thus, it is recommended for the guest TD to use PEBS instead of PMIs in order to record TD state at counter overflows.

Uncore PMIs are discussed in 15.4 below.

15.3. Off-TD Debug

A guest TD is defined as **debuggable** if its ATTRIBUTES.DEBUG bit is 1. In this mode, the host VMM can use Intel TDX module functions to read and modify TD VCPU state and TD private memory, which are not accessible when the TD is non-debuggable.

A debuggable TD is, by nature, untrusted. Since the TD's ATTRIBUTES are included in the TDREPORT_STRUCT, the TD's debuggability state is visible to any third party to which the TD attests.

A debuggable TD can't be migrated; its ATTRIBUTES.MIGRATABLE bit must be 0.

The applicable Intel TDX module functions are listed in Table 15.3 below. Note that some of the functions can access non-secret guest TD state regardless of the DEBUG attribute. The lists of state information that can be read and/or written in non-DEBUG and in DEBUG modes are detailed in the referenced sections.

Table 15.3: Off-TD Debug Interface

Intel TDX Function	ATTRIBUTES.DEBUG = 0	ATTRIBUTES.DEBUG = 1
TDH.MNG.RD TDH.MNG.WR	N/A	Access secret and non-secret TD-scope state in TDR and TDCS.
TDH.MEM.SEPT.RD	Read Secure EPT entry	Read Secure EPT entry
TDH.VP.RD TDH.VP.WR	Access non-secret TD VCPU state in TDVPS (including TD VMCS)	Access secret and non-secret TD VCPU state in TDVPS (including TD VMCS).
TDH.MEM.WR/ TDH.MEM.RD	N/A	Access TD-private memory.
TDH.PHYMEM.PAGE.RDMD	Read page metadata (PAMT information)	Read page metadata (PAMT information).

15.3.1. Modifying Debuggable TD's State, Controls and Memory

When the TD is debuggable, the off-TD debugger can:

- 5 • Read and modify TDVMCS fields that contain guest state, VM entry load controls, VM exit save controls, and VM execution controls.
- Read and modify TDVPS fields that contain additional TD VCPU's state (e.g., extended register state).
- Read and modify a per-VCPU copy of the TD's extended feature mask (XFAM), such that more extended register state would be saved to TDVPS on TD exit and restore from TDVPS on TD entry.

10 This may cause the next VM entry into the TD VCPU to fail due to bad guest state. It may also generate VM exits that wouldn't have happened otherwise (e.g., VM exit due to a #PF within the TD). In non-debuggable TD such VM exits are not expected, and thus treated as fatal TDX module error and lead to shutdown. In debuggable TDs, however, such VM exits are expected and cause TD exit.

Specifically, the TDX module handling of TD VM exits works as follows:

- 15 1. If this TD VM exit might happen on non-debuggable TDs:
 - 1.1. Do "standard" handling (may result a TD exit).
 - 1.2. If an exception is pending to be injected into the TD:
 - 1.2.1. If the TD is debuggable and its exception bitmap is programmed to intercept that exception:
 - 1.2.1.1. TD exit to the VMM, as if the exception has been raised during TD execution.
 - 1.3. Resume the TD (may inject an exception).
 - 20 2. Else (an unexpected VM exit happened):
 - 2.1. If the TD is debuggable then TD exit.
 - 2.2. Else handle this as a fatal error.

In any case, the security of other guest TDs running in production mode is not impacted.

25 15.3.2. Preventing Guest TD Corruption of DRs

The off-TD (host-side) debugger may need to have full control over guest DRs to help prevent their corruption by the guest TD. To do so, the debugger can do the following:

- Use TDH.VP.WR to set the TD VMCS GUEST_DR7 field's Global Detect bit.
- Set the TD VMCS exception bitmap execution control to intercept debug exceptions.

30 15.4. Uncore Performance Monitoring Interrupts (Uncore PMIs)

By design, neither the Intel TDX module itself nor its guest TDs are allowed to use Uncore PMIs. The state of IA32_DEBUGCTL MSR bit 13 (ENABLE_UNCORE_PMI) is preserved across SEAMCALL, SEAM root and non-root mode and SEAMRET, except for very short time periods immediately after SEAMCALL and VM exit.

16. Memory Integrity Protection and Machine Check Handling

16.1. Overview

The Intel TDX module's memory integrity protection and machine check handling are designed to answer address the following security objectives:

- 5 • Corruption of TD private data or Intel TDX module memory must be detectable before the decrypted corrupted data are consumed by the guest TD or by the Intel TDX module.
- To help improve resistance to brute force attacks, software must not be able to **repeatedly** cause memory integrity violations during Intel TDX module or guest TD operation. When an integrity violation is detected, the affected guest TD and the key corresponding to its affected HKID must become unusable for normal operation of the TD – i.e., the TD may only be torn down.
- 10 • Any software except guest TD or TDX module must not be able to speculatively or non-speculatively access TD private memory, to detect if a prior corruption attempt was successful in finding an integrity collision or failed and received zero-data.

As a **best effort**, the TDX module is designed to enable limiting the impact of memory integrity violations in a guest TD context to that guest TD, i.e., requiring only that guest TD to be torn down. However, there are cases where memory integrity violations result in an unbreakable shutdown of the LP.

16.2. TDX Memory Integrity Protection Background

16.2.1. Cryptographic Integrity (Ci) vs. Logical Integrity (Li), MAC and TD Owner

20 TDX architecture aims to provide resiliency against confidentiality and integrity attacks by software. Towards this goal, the TDX architecture helps enforce the enabling of memory integrity for all private HKIDs. It supports two memory integrity modes that can be configured on the platform:

Cryptographic Integrity (Ci) Memory content is encrypted and protected by a MAC and a TD Owner bit.

Logical Integrity (Li) Memory content is encrypted and protected by a TD Owner bit.

25 In both Ci and Li modes, the memory controllers store a 1-bit **TD Owner** metadata each cache. The TD Owner bit is set to 1 for writes with a private HKID and is cleared to 0 for writes with a shared HKID. The TD Owner bit is covered by ECC.

When Ci mode is enabled, the CPU's memory controllers compute a 28-bit integrity check value (**MAC**) for the data (cache line) during writes and store the MAC with the memory as meta-data. The MAC is calculated over the components described in the table below. The MAC is covered by ECC.

Table 16.1: Components for MAC Calculation (Ci Mode)

Component	Description
Ciphertext Data	512 bits of data being written to memory.
Encryption Tweak	128-bit encryption tweak, generated by encrypting the physical address with the 128-bit per-HKID ephemeral AES-XTS tweak key. The tweak key is generated on key configuration (TDH.SYS.KEY.CONFIG and TDH.MNG.KEY.CONFIG).
TD Owner Bit	Indicates that the data was written using a private HKID.
MAC Key	128-bit MAC key, generated by hardware on platform initialization, when BIOS configures the IA32_TME_ACTIVATE MSR.

30

16.2.2. MAC and TD Owner Update on Memory Writes

The MAC and the TD Owner bit are updated on memory writes by the memory controller per the following criteria:

- If memory write is for a private HKID, the TD Owner bit is set, and integrity information (MAC) is computed and stored as meta-data along with ciphertext in memory.
- 35 • Else (write is for a shared HKID), the TD Owner bit is clear, and based on the key configuration, integrity information (MAC) may be stored along with ciphertext in memory.

The state diagram below shows the TD Owner bit state changes due to memory state changes.

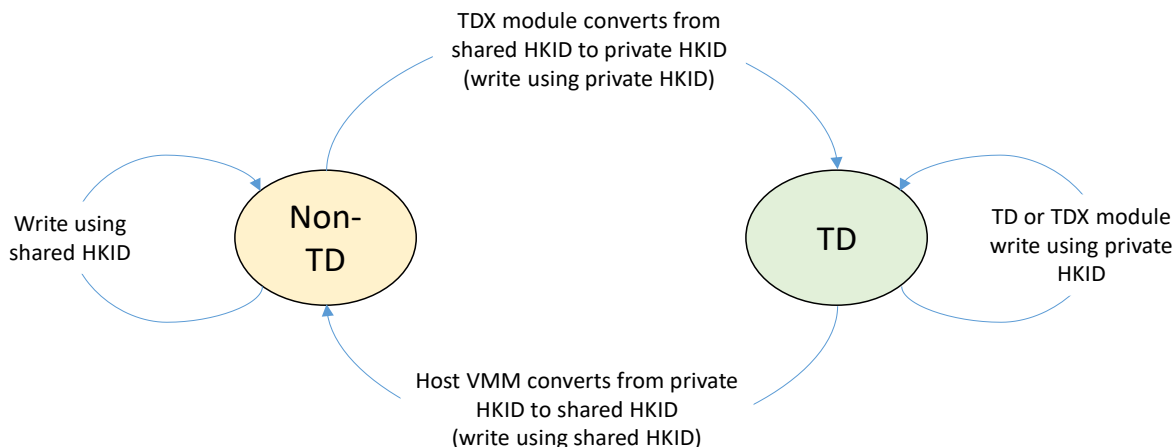

Figure 16.1: TD Owner Bit Setting on Write

16.2.3. Memory Reads: Integrity and TD Owner Bit Checks, Poison Generation and Poison Consumption

- 5 Checks on memory reads depend on whether Cryptographic Integrity (Ci) is enabled on the platform, or Logical Integrity (Li) is used. This is shown in the tables below.
- When the memory read transaction uses a private HKID, TD Owner bit mismatch and/or integrity check failure (for Ci) result in a new poison generation. An all-0 data is returned, with a poison indication.
 - 10 • The poison indication is sticky; it is stored back to memory. Subsequent read transactions that read a previously poisoned memory line return a poison indication regardless of the TD Owner bit or integrity checks. A sticky poison indication is cleared when the whole memory line is written; the correct way to do so is by using the MOVDIR64B instruction.
 - 15 • Any reads of TD private data (TD Owner is 1) done outside SEAM mode (i.e., with a shared HKID) return all-0. This is intended to prevent the host VMM from testing malicious ciphertext for a MAC collision, since the VMM will deterministically see zeroed data in the cache for speculative accesses, which on subsequent non-speculative accesses will cause a machine check event. No new poison indication is returned; however, a previous poison indication that has been stored in memory may be returned.

Table 16.2: Checks on Memory Reads in Ci Mode

HKID Type	Integrity Enabled for HKID	TD Owner Bit	Integrity Check	Returned Data	New Poison	Comments
Private	Yes	0	N/A	0	Poison	This combination is prevented by the TDX module's private memory mapping using Secure EPT. See Ch. 9 for details.
		1	Pass	Decrypted data	None	If the memory line has been previously poisoned, the read transaction may return a poison.
		1	Fail	0	Poison	This combination is prevented by the TDX module's private memory mapping using Secure EPT. See Ch. 9 for details.
Shared	Yes	0	Pass	Decrypted data	None	If the memory line has been previously poisoned, the read transaction may return a poison.
		0	Fail	0	Poison	
		1	N/A	0	Poison	
Shared	No	0	N/A	Decrypted data	None	If the memory line has been previously poisoned, the read transaction may return a poison.
		1	N/A	0	None	If the memory line has been previously poisoned, the read transaction may return a poison.

Table 16.3: Checks on Memory Reads in Li Mode

HKID Type	Integrity Enabled for HKID	TD Owner Bit	Integrity Check	Returned Data	New Poison	Comments
Private	No	0	N/A	0	Poison	This combination is prevented by the TDX module's private memory mapping using Secure EPT. See Ch. 9 for details.
		1	N/A	Decrypted data	None	If the memory line has been previously poisoned, the read transaction may return a poison.
Shared	No	0	N/A	Decrypted data	None	If the memory line has been previously poisoned, the read transaction may return a poison.
		1	N/A	0	None	If the memory line has been previously poisoned, the read transaction may return a poison.

- 5 Memory integrity errors that result in poison generation are logged by the memory controller as **UCNA** (uncorrected no-action required) UCR errors which are signaled via CMCI (if CMCI is enabled) or CSMI (if enabled).

On a subsequent consumption (read) of the poisoned data by software, there are two possible scenarios:

Machine Check: In most cases, the core determines that the execution can continue, and it treats poison with fault-like exception semantics signaled as an **MCE** (Machine Check Exception) or **MSMI** (Machine-check System Management Interrupt).

10

Handling of machine check events (MCE or MSMI) when executing in a guest TD (in SEAM non-root mode) and in the Intel TDX module (in SEAM root mode) is described in the following sections.

Unbreakable Shutdown: In some cases, the core determines that execution cannot continue (e.g., long μ Code flows), and it goes into an unbreakable shutdown.

An unbreakable shutdown that happens while running in SEAM mode, either in a guest TD or in the TDX module, globally marks TDX as disabled – all subsequent SEAMCALL invocations on any logical processor of the platform lead to a VMfailInvalid error.

16.2.4. Memory Writes: No Integrity nor TD Owner Bit Checks

The TD Owner bit is not checked on memory writes. It is the responsibility of the host VMM to prevent writing to memory that has been assigned as TD private memory. Failing to do so will result in a memory corruption; such corruption will be detected when the guest TD or the TDX module attempts to read that memory, as described above.

The host VMM should always initialize memory that has been used with a private HKID (i.e., TD private memory and TDX control structures), and is about to be used with a shared HKID, using a full line write. The correct way to do so is by using the MOVDIR64B instruction. This helps ensure that the TD Owner bit and any stored poison indication are cleared.

16.3. Machine Check Architecture (MCA) Background

Intel SDM, Vol. 3, 15

Machine-Check Architecture

The **machine-check architecture (MCA)** provides a mechanism for detecting and reporting hardware (machine) errors. These include system bus errors, ECC errors, parity errors, cache errors and TLB errors. MCA consists of a set of model-specific registers (MSRs) that are used to set up machine checking, and it includes additional banks of MSRs used for recording errors that are detected.

16.3.1. Uncorrected Machine Check Error

The processor signals the detection of an **uncorrected machine-check error** by generating a **machine-check exception (MCE)**, which is a fault-like exception. An MCA enhancement supports software recovery from certain uncorrected **recoverable** machine check errors. Poisoned cache line consumption by the guest TD is considered such an error. The machine-check exception handler is expected to be implemented in the VMM.

16.3.2. Corrected Machine Check Interrupt (CMCI)

Intel SDM, Vol. 3, 15.5

Corrected Machine Check Error Interrupt

Processors on which TDX will be supported can also report information on corrected machine-check errors and deliver a programmable interrupt for software to respond to MC errors – referred to as **corrected machine-check interrupt (CMCI)**.

CMCI is delivered as a normal interrupt. If delivered during guest TD operation, this interrupt causes a VM exit, and Intel TDX module performs a TD exit to the host VMM. If delivered during Intel TDX module operation, this interrupt remains pending until either SEAMRET to the host VMM or until VM entry to a guest TD.

16.3.3. Machine Check System Management Interrupt (MSMI)

MSMI is part of the Enhanced Machine Check Architecture, Gen. 2 (EMCA2). With EMCA2 enabled, each machine check bank can be configured to assert SMI instead of MCE or CMCI. This is intended to allow the SMM handler to correct the error when possible. For details, see [Error Reporting through EMCA2].

16.3.4. Local Machine Check Event (LMCE)

Intel SDM, Vol. 3, 15.3.1.5

Enabling Local Machine Check

When system software has enabled LMCE, then hardware will determine if a particular error can be delivered only to a single logical processor, instead of being broadcast to all logical processors. This is the recommended configuration for TDX.

16.4. Recommended MCA Platform Configuration for TDX

The following platform MCA configuration is recommended for TDX:

- LMCE should be enabled, so that machine check events that happen in the scope of a certain logical processor are delivered only to that logical processor.
- EMCA2 should be disabled on core MC banks (IFU and DCU), so that the host VMM can handle memory integrity errors by tearing down a single TD, instead of shutting down the whole platform.

The following sections provide additional details.

16.5. Handling Machine Check Events during Guest TD Operation

16.5.1. Machine Check Events Delivered as an #MC Exception (Recommended)

If EMCA2 is not enabled on the core MC banks (IFU and DCU), the machine check event is delivered as an #MC exception. With LMCE enabled, the MCE is delivered only to the logical processor that consumed the poisoned cache line.

The Intel TDX module configures the MCE events when they occur in a TD guest to cause a VM exit to the Intel TDX module. This includes the following cases:

- MCE during guest TD operation
- MCE during a successful VM entry to a guest TD
- MCE during a failed VM exit, where normally execution would remain in the guest TD

The Intel TDX module implements this as follows:

- The Intel TDX module enforces guest TD CR4.MCE to 1.
- The Intel TDX module sets bit 18 (MC) of the TD VMCS Exception Bitmap to 1.

On VM exit, if the exit reason is Exception or NMI (0), the Intel TDX module reads the TD VMCS' VM-exit interruption information to determine if the VM exit was caused by a #MC (18). If so, the Intel TDX module puts the TD in a FATAL state, preventing further TD entries. The TDX module then completes the TD exit flow. The TDH.VP.ENTER outputs indicate the status as TDX_NON_RECOVERABLE_TD_FATAL and provides the exit reason, exit qualification and exit interruption information.

Note: The TDX module does not analyze the MCE to determine its source – whether it's a memory integrity violation or some other event.

Based on the TDH.VM.ENTER outputs (exit reason etc.), the host VMM is expected to understand that a Machine Check event happened, and that the TD should be torn down.

The host VMM can reclaim memory assigned to TDs in a FATAL state using the normal TD teardown flow (TDH.VP.FLUSH, TDH.MNG.VPFLUSHDONE, TDH.PHYMEM.CACHE.WB, TDH.MNG.KEY.FREEID, TDH.PHYMEM.PAGE.RECLAIM).

Note: The host VMM should not attempt to read the poisoned memory locations. Doing so results in a poison consumption and an MCE in the VMM context.

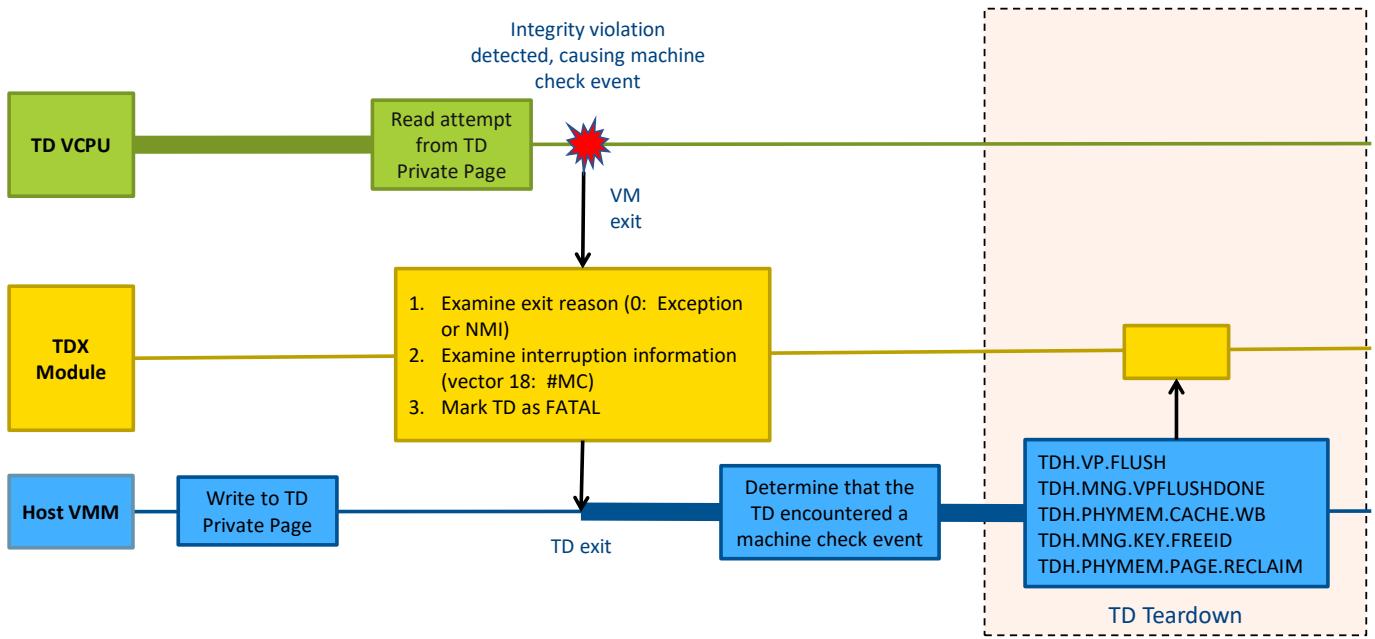

Figure 16.2: Example of Handling an MCE in a TD Context

16.5.2. Machine Check Events Delivered as an MSMI (Not Recommended)

If EMCA2 is enabled on the core MC banks (IFU and DCU), the machine check event is delivered as an MSMI. With LMCE enabled, the MSMI is delivered only to the logical processor that consumed the poisoned cache line.

Contrary to non-TDX operation, an SMI that occurs in a TD guest does not immediately invoke the SMM handler. Instead, an SMI causes a VM exit to the Intel TDX module and remains pending.

On VM exit, if the exit reason is Other SMI (6), the Intel TDX module reads the TD VMCS' exit qualification bit 0 to determine if the VM exit was caused by a Machine Check that was mutated into an SMI. If so, the Intel TDX module puts the TD in a FATAL state, preventing further TD entries. The TDX module then completes the TD exit flow. The TDH.VP.ENTER outputs indicate the status as TDX_NON_RECOVERABLE_TD_FATAL and provides the exit reason and exit qualification.

Note: The TDX module does not analyze the MCE to determine its source – whether it's a memory integrity violation or some other event.

Once TD exit has completed and the CPU is no longer in SEAM mode, the pending SMI event is taken and the platform's SMM handler is invoked. On RSM, the SMM handler injects an #MC to the host VMM.

The host VMM needs to understand that the reported machine check event happened during TD execution and may be handled by tearing down the TD. However, this may not be simple to implement. Thus, **EMCA2 enabling on the core MC banks is not recommended for TDX.**

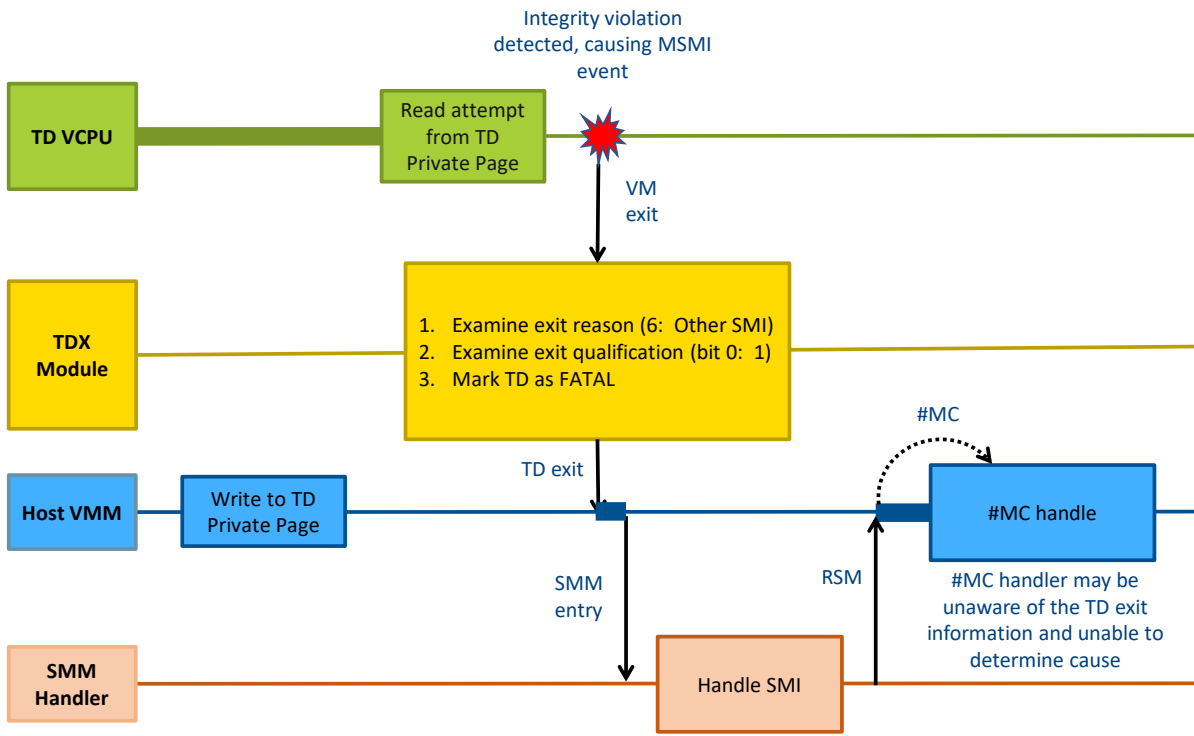

Figure 16.3: Example of Handling an MSI in a TD Context

16.5.3. LMCE Disabled (Not Recommended)

If LMCE is disabled, then an MCE or MSMI is broadcast to all logical processors on the platform. Any TD that happens to be running will be put in a FATAL state.

Note: The TDX module does not check the MCE details. Any MCE that causes a VM exit from a guest TD is considered fatal to that TD.

16.5.4. Machine Check Events Delivered as a CMCI

CMCI is treated as a normal interrupt, causing an asynchronous TD exit; there's no special handling.

On VM exit, if the exit reason is Exception or NMI (0), the Intel TDX module reads the TD VMCS' VM-exit interruption information to determine if the VM exit was caused by a #MC (18). If not, the Intel TDX module completes the TD exit flow. The TDH.VP.ENTER outputs indicate the status as TDX_SUCCESS and provides the exit reason, exit qualification and exit interruption information.

Based on the TDH.VM.ENTER outputs, the host VMM is expected to process the CMCI interrupt.

16.6. Handling MCE during Intel TDX Module Operation

Any machine check event that occurs during Intel TDX module operation (in SEAM root mode) forces an unbreakable shutdown on a current LP. Shutdown also globally marks TDX as disabled – all subsequent SEAMCALL invocations on any logical processor of the platform lead to a VMfailInvalid error.

17. UPDATED: Side Channel Attack Mitigation Mechanisms

17.1. UPDATED: Checking and Virtualization of CPU Side Channel Protection Mechanisms

Enumeration

17.1.1. IA32_ARCH_CAPABILITIES MSR

- 5 On TDX module initialization (TDH.SYS.INIT and TDH.SYS.LP.INIT), the TDX module reads the IA32_ARCH_CAPABILITIES MSR to check the value of multiple bits, indicating whether the CPU is vulnerable to a list of known attacks. The TDX module virtualizes the IA32_ARCH_CAPABILITIES MSR, as seen by guest TDs. Some of the bits are configurable, to allow TD migration between dissimilar platforms. For more information, refer to 11.7.2 and to the [ABI Spec].

Table 17.1: IA32_ARCH_CAPABILITIES MSR Checks and Virtualization

Bit(s)	Name	Verified on TDX Module Init	Virtual Value as Seen by Guest TDs
0	RDCL_NO	1	1
1	IBRS_ALL	1	1
2	RSBA	0	0
3	SKIP_L1DFL_VMENTRY	1	1
4	SSB_NO	Same on all LPs	Configurable by the host VMM – can allow to be 1
5	MDS_NO	1	1
6	IF_PSCHANGE_MC_NO	1	1
7	TSX_CTRL	Same on all LPs	Configurable by the host VMM – allowed to be 1 only if CPUID configuration enables TSX
8	TAA_NO	1	1
9	RESERVED	Same on all LPs	0
10	MISC_PACKAGE_CTRL	1	1
11	ENERGY_FILTERING_CTL	1	1
12	DOITM	1	1
13	SBDR_SSDP_NO	1	1
14	FBSDP_NO	1	1
15	PSDP_NO	1	1
16	RESERVED	Same on all LPs	0
17	FB_CLEAR	Same on all LPs	0
18	FB_CLEAR_CTRL	Same on all LPs	0
19	RRSBA	Same on all LPs	Configurable by the host VMM – can force to 1
20	BHI_NO	Same on all LPs	Configurable by the host VMM – can allow to be 1
21	XAPIC_DISABLE_STATUS	1	
22	RESERVED	Same on all LPs	
23	OVERCLOCKING_STATUS	Same on all LPs	
24	PBRBSB_NO	Same on all LPs	Configurable by the host VMM – can allow to be 1
63:25	RESERVED	Same on all LPs	

17.1.2. CPUID

On TDX module initialization (TDH.SYS.INIT and TDH.SYS.LP.INIT), the TDX module reads some CPUID fields to check the value of multiple bits, indicating whether the CPU is vulnerable to a list of known attacks. The TDX module virtualizes the CPUID values, as seen by guest TDs. Some of the bits are configurable, to allow TD migration between dissimilar platforms. For more information, refer to 11.8 and to the [ABI Spec].

Table 17.2: Checks and Virtualization of Side Channel Related CPUID Fields

Leaf	Sub-Leaf	Reg.	Bit	Name	Verified on TDX Module Init	Virtual Value as Seen by Guest TDs
7	0	EDX	9	MCU_OPT	0	0
			10	MD_CLEAR	1	1
			13	TSX_FORCE_ABORT	0	0
			26	IBRS and IBPB support	1	1
			27	STIBP support	1	1
			28	L1D_FLUSH support	1	1
			29	IA32_ARCH_CAPABILITIES	1	1
			30	IA32_CORE_CAPABILITIES	1	1
			31	SSBD supported	1	1
	2	EDX	0	PSFD supported	1	1
			1	IPRED_CTRL	1	1
			2	RRSBA_CTRL	1	1
			3	DDPD	Same on all LPs	Configurable by the host VMM – can allow to be 1
			4	BHI_NO	1	
5	MCDT_NO	Same on all LPs	Configurable by the host VMM – can allow to be 1			

17.2. **UPDATED:** Branch Prediction Side Channel Attacks Mitigation Mechanisms

Branch predictions cached by the CPU before entering a guest TD should not impact the behavior of that TD. The Intel TDX module helps ensure that by applying CPU mechanisms to isolate the branch predictions of each guest TD from branch predication done outside its execution.

In a partitioned TD, the L1 VMM is responsible for isolating indirect branch predictors (IBPs) between the L1 VMM and L2 VMMs. The L1 VMM should issue an indirect branch prediction barrier (IBPB) command to the CPU, by writing the IA32_PRED_CMD MSR with the IBPB bit set, immediately before L1→L2 VM entry and immediately after L2→L1 VM exit.

17.3. **UPDATED:** Single-Step and Zero-Step Attacks Mitigation Mechanisms

17.3.1. **UPDATED:** Description

Single-step attacks, zero-step attacks and EPT fault attacks are techniques that provide an adversary with access to a class of powerful, low-noise side channel attacks. They do so by exploiting control over hardware such as fine resolution APIC timers and using TDX module memory management interface functions.

- **Single-Step Attacks** involve timing pin-based events such as interrupts, NMI, SMI and INIT to interrupt the guest TD execution after every instruction executed in the guest TD. This allows the attacker to examine the state of the machine following each instruction execution in interesting regions of code and use side channels to leak information used by that region of code.

- **EPT Fault Attacks** involve causing EPT violations or EPT misconfigurations to infer the control flow of execution inside a guest TD. Such control flow inference coupled with other side channel techniques, such as branch shadowing, can be used as a side channel to leak information from the guest TD.
- **Zero-Step Attacks** involve using an EPT fault on targeted instructions in a guest TD with an intent to glean side channel information from speculative execution past the faulting instruction. Such instructions are called “replay anchors”, as every resumption of the TD execution leads to the same EPT fault and thus the same speculative execution with the same stimulus to be replayed repeatedly, such that noise in side-channel observation of that speculative execution can be reduced.

The Intel TDX module provides mechanisms to help assist in mitigating single and zero step attacks:

- For single step attacks, the TDX module detects when a TD VCPU gets interrupted soon (~4K cycles) after it was entered; it continues to provide execution opportunities to the TD VCPU for a small random number of instructions before the interruption is delivered to the host VMM.
- For zero step attacks, the Intel TDX module counts Secure EPT faults that result in a TD exit. After a pre-determined number of such EPT violations occur on the same instruction, the TDX module starts tracking the GPAs that caused Secure EPT faults and fails further host VMM attempts to enter the TD VCPU unless previously faulting private GPAs are properly mapped in the Secure EPT.

Note: For a partitioned TD, EPT violations that happen in the context of L2 VMs may result in a TD exit or in an L2→L1 exit. Only the TD exit cases are counted for the purpose of zero step attack detection.

17.3.2. UPDATED: Host VMM Expected Behavior

No change is required to the host VMM’s normal memory management behavior:

- The host VMM should block (TDH.MEM.RANGE.BLOCK) TD private pages and remove them (TDH.MEM.PAGE.REMOVE) only after the guest TD has explicitly relinquished the ownership of that page through a software protocol between the VMM and the TD. Such a protocol is implemented by the balloon driver mechanism employed by guest Linux kernel to allow the host VMM to overcommit a guest VM assigned memory.
- The host VMM can block TD private pages and perform the following GPA-to-HPA mapping updates without coordination with the guest TD:
 - Physical page relocation (TDH.MEM.PAGE.RELOCATE)
 - Mapping merge or split (TDH.MEM.PAGE.PROMOTE, TDH.MEM.PAGE.DEMOTE)
 - Unblock (TDH.MEM.RANGE.UNBLOCK)

A guest TD VCPU attempt to access such pages while they are blocked results in an EPT violation TD exit. A well-behaved host VMM should not re-enter the TD until the mapping operation is done. Failing to do so will immediately result in another EPT violation and the TD VCPU won’t make any progress.

- The host VMM can block TD private pages for writing (TDH.EXPORT.BLOCKW) as part of TD migration. A guest TD VCPU attempt to write to such pages while they are blocked for writing results in an EPT violation TD exit. A well-behaved host VMM should not re-enter the TD VCPU before unblocking the page (TDH.EXPORT.UNBLOCKW). Failing to do so will immediately result in another EPT violation and the TD VCPU won’t make any progress.

17.3.3. UPDATED: Guest TD Interface and Expected Guest TD Operation

The TDX module provides the guest TD with a notification facility, by which the guest TD can get notified when excessive Secure EPT violations are raised by the same TD instruction. This mechanism allows the guest TD to employ its own policies. The guest TD enables this notification by setting bit 0 of TDCS.NOTIFY_ENABLES field, using TDG.VM.WR. If this bit is set, then when more than a pre-determined number of Secure EPT violations are detected on the same instruction,

- If the EPT violation happened when L1 was running (i.e., the TD is not partitioned, or L1 VMM was running) the TDX module injects a #VE exception, with the EPT violation details.
- If the TD is partitioned, and the EPT violation happened when an L2 VM was running, the TDX module induces an L2→L1 exit. The EPT violation details are provided in the exit information.

As part of its normal memory management behavior, the guest TD should track its GPA space allocation and should only accept (TDG.MEM.PAGE.ACCEPT) PENDING pages that it expects to be added (TDH.MEM.PAGE.AUG) by the host VMM. Failing to do so would make the TD vulnerable to attacks, e.g., the host VMM could zero-out a page by removing it and adding a new one at the same GPA.

Thus, when the guest TD attempts to access a page and a #VE is raised indicating an EPT violation, the expected guest TD's #VE handler behavior is as follows:

- 5 • If this page is not known to the guest TD as owned by it, i.e., it was not added at TD build time (TDH.MEM.PAGE.ADD) and has not been added dynamically (TDH.MEM.PAGE.AUG) and accepted (TDG.MEM.PAGE.ACCEPT), the guest TD can accept this page normally.
 - Otherwise, this may indicate an attack and the guest TD can employ its own policy. For example, the guest TD may halt if this page is one of the pages expected to be resident when a security critical workload is executing. Alternatively, it may signal the current running application so that the application would employ application-specific defenses.
- 10 The guest TD's #VE handler, as well as its virtual NMI handler, should not have any secrets that are susceptible to leakage. The Intel TDX module does not provide protection against attacks when accessing **shared** pages. The guest TD should treat shared memory access as communicating with a potential attacker, and not do any secure processing while accessing to shared memory.

DRAFT

18. UPDATED: General Aspects of the Intel TDX Interface Functions

18.1. Concurrency Restrictions and Enforcement

18.1.1. Explicit Concurrency Restrictions

Intel TDX functions may specify concurrency restrictions on accessing one or more resources, as described below. In most cases, the restriction applies for the duration of the instruction execution. However, in some cases, the restriction applies for a longer duration. For example, TDH.VP.ENTER requires shared access to the TD-scope logical control structures TDR and TDCS, and it also requires shared access to TDVPS – the VCPU-scope logical control structure which applies during logical TDX non-root operation through TD Exit.

Table 18.1: Concurrency Restrictions of Intel TDX Functions or Flows

Concurrency Restriction	Description	Examples
Exclusive Access	During the period when an LP has an exclusive access to a certain resource, any attempt by another LP to concurrently execute an instruction that requires either an exclusive or a shared access to the same resource will fail.	<ul style="list-style-type: none"> TDH.VP.CREATE requires an exclusive access to the TDVPR page.
Shared Access	During the period when an LP has a shared access to a certain resource, any attempt by another LP to concurrently execute an instruction that requires an exclusive access to the same resource will fail. No such restriction exists on another LP that attempts to concurrently execute an instruction that requires a shared access.	<ul style="list-style-type: none"> TDH.VP.CREATE requires a shared access to the TDR page. TDH.PHYMEM.CACHE.WB requires a shared access to the KOT.

Software is expected to comply with the specified concurrency restrictions. The Intel TDX module helps enforce them (using internal locks) for proper TDX operation.

Table 18.2: Concurrency Restrictions Cross-Table

		Logical Processor Y		
		Concurrency Restriction	Exclusive	Shared
Logical Processor X	Exclusive	Not Allowed	Not Allowed	Allowed
	Shared	Not Allowed	Allowed	Allowed
	None	Allowed	Allowed	Allowed

Intel TDX functions do not wait on a resource that requires an exclusive or a shared access. If the resource is busy, the function fails immediately.

18.1.2. Implicit Concurrency Restrictions

In some cases, Intel TDX functions and whole flows (e.g., TD Entry through TD Exit) may have **implicit** exclusive or shared access to resources. This means that the access restriction is implied by the architecture, but no direct enforcement is made by the flow itself.

An important case is logical TDX non-root mode. TDH.VP.ENTER acquires shared locks on the TD’s TDR and TDCS control structures and on the VCPU’s TDVPS control structure. These shared locks are released only on TD exit. Thus, during all the time the LP is in the logical TDX non-root mode, including during TDCALL leaf functions, the LP has implicit shared access to TDVPS, TDR and TDCS.

18.1.3. Transactions

In some cases, Intel TDX module flows update some state as a transaction. They first read the current state, then do some calculations and eventually attempt to update the state using an atomic operation (e.g., LOCK_CMPXCHG) to check that the state has not changed and set its new value. If that check fails, an Intel TDX module interface function may fail with a TDX_OPERAND_BUSY status.

18.1.4. NEW: Concurrency Restrictions with Host Priority

18.1.4.1. Overview

Host priority is a variant on explicit concurrency restrictions, where the host VMM side is given priority over guest TD side. A new HOST_PRIORITY flag is added to locks protecting resources that may be accessed by the host VMM and a guest TD. Both mutexes and shared/exclusive locks can be enhanced with host priority.

18.1.4.2. Host-Side (SEAMCALL) Operation

The host VMM is expected to retry host-side operations that fail with a TDX_OPERAND_BUSY_HOST_PRIORITY status. The host priority mechanism helps guarantee that at most after a limited time (the longest guest-side TDX module flow) there will be no contention with a guest TD attempting to acquire access to the same resource.

Lock operations process the HOST_PRIORITY bit as follows:

- A SEAMCALL (host-side) function that fails to acquire a lock sets the lock's HOST_PRIORITY bit and returns a TDX_OPERAND_BUSY_HOST_PRIORITY status to the host VMM. It is the host VMM's responsibility to re-attempt the SEAMCALL function until it succeeds; otherwise, the HOST_PRIORITY bit remains set, preventing the guest TD from acquiring the lock.

Note: Beginning with the next TDX module release, the status code returned to the host VMM will be TDX_OPERAND_BUSY.

- A SEAMCALL (host-side) function that succeeds to acquire a lock clears the lock's HOST_PRIORITY bit.

18.1.4.3. Guest-Side (TDCALL) Operation

A TDCALL (guest-side) function that attempt to acquire a lock fails if HOST_PRIORITY is set to 1; a TDX_OPERAND_BUSY_HOST_PRIORITY status is returned to the guest. The guest is expected to retry the operation.

Note: Beginning with the next TDX module release, the status code returned to the guest TD will be TDX_OPERAND_BUSY. This change will be done to preserve backward compatibility with TDX 1.0.

Guest-side TDCALL flows that acquire a host priority lock have an upper bound on the host-side latency for that lock; once a lock is acquired, the flow either releases within a fixed upper time bound, or periodically monitor the HOST_PRIORITY flag to see if the host is attempting to acquire the lock.

18.1.4.4. Host Priority Busy Timeout

Once a host-side operation failed with a TDX_OPERAND_BUSY_HOST_PRIORITY status, the host VMM should retry this operation until it no longer fails with the same TDX_OPERAND_BUSY_HOST_PRIORITY status. Otherwise, the guest TD may be stuck trying to acquire a lock where the HOST_PRIORITY bit is set.

The TDX module implements a timeout mechanism for guest-side host priority lock acquisition failures. If the guest TD loops on a TDCALL (guest-side) function that fails with TDX_OPERAND_BUSY_HOST_PRIORITY status for more than a configurable timeout, the TDX module initiates a trap-like TD exit with a TDX_HOST_PRIORITY_BUSY_TIMEOUT status. It is expected that this will never happen with a properly operating host VMM. However, it is still possible for the host VMM to resolve the lock contention by calling the SEAMCALL function that previously failed with a TDX_OPERAND_BUSY_HOST_PRIORITY status until successful, and then re-entering the guest TD by calling TDH.VP.ENTER with the HOST_RECOVERABILITY_HINT bit cleared to 0. For details, see the [TDX Module ABI Spec].

The host priority timeout's default value is 1 second. It is configurable between 10 msec to 100 seconds by using TDH.MNG.WR to update TDCS.HP_LOCK_TIMEOUT.

18.2. Memory and Resource Operands Access

Intel SDM, Vol. 3, 11.5.2	Precedence of Cache Controls
Intel SDM, Vol. 3, 11.11	Memory Type Range Registers (MTRRs)
Intel SDM, Vol. 3, 11.12	Page Attribute Table (PAT)

5 18.2.1. Overview

In this section, we discuss Intel TDX functions' memory and resource operands access from the following perspectives:

- Access semantics (shared, private, opaque and hidden)
- Explicit vs. implicit accesses
- Operand address specification (host-physical address, guest-physical address)
- 10 • Actual memory access (read or write) vs. memory reference

18.2.1.1. Access Semantics

Access semantics, as used in this document, convey the intended purpose of the access. Intel TDX functions are designed to use one of the following access semantics when accessing their memory and/or platform resource parameters:

Table 18.3: Access Semantics Definition

Access Semantics	Description	Intel TDX Module Usage
Shared	Memory is accessed using one of the shared HKIDs (in the range 0 to MAX_MKTME_HKIDS - 1). This is mostly used for memory parameters accessed by the VMM.	<ul style="list-style-type: none"> • Source page of TDH.MEM.PAGE.ADD • Memory operands of TDCALL leaf functions
Private	The memory is mapped in the TD's private GPA space. Memory accessed using the target TD's private HKID (in the range MAX_MKTME_HKIDS - 1 to MAX_HKIDS - 1). Such memory pages can be mapped in the TD's private GPA space.	<ul style="list-style-type: none"> • TD private pages • Secure EPT pages
Opaque	Memory is addressable by the host VMM, but its content is not directly accessible to software or devices. Memory is encrypted using either the Intel TDX global private key (for TDR) or the TD's ephemeral private key (for other control structures).	<ul style="list-style-type: none"> • TDR • TDCX • TDVPR
Hidden	Access is to an Intel TDX module internal resource. That resource is not directly addressable as a memory operand to software or devices.	<ul style="list-style-type: none"> • KOT • WBT

15

Note that on guest-side (TDCALL) functions, shared vs. private semantics is determined by the GPA provided as an operand to the function. A specific TDCALL leaf function may or may not impose a private or a shared access – e.g., TDG.MEM.PAGE.ACCEPT requires a private GPA, while TDG.MR.REPORT may work with either a private GPA or a shared GPA.

20 18.2.1.2. Explicit vs. Implicit Access

An **explicit memory access** is defined as an access where the memory location is provided as explicit operand to an Intel TDX function. The address may be provided directly in a GPR or indirectly via some address field in a software-accessible memory data structure.

The HKID for accessing the memory can be inferred by the instruction – implicitly or explicitly from the explicitly provided access.

25

An **implicit memory access** is defined as an access to a platform physical memory address, or to some other resource, that is not passed as an operand of an instruction (either directly or indirectly) but is implied by use of the Intel TDX function. TDX architecture helps guarantee that an implicit access is performed correctly, or a proper error action is taken.

5 18.2.1.3. *Memory Operand Address Specification*

Host-side Intel TDX functions (SEAMCALL leaf functions) memory operands are specified using their **host-physical address (HPA)**, their **guest-physical address (GPA)**, or when a GPA-to-HPA mapping is done (e.g., TDH.MEM.PAGE.ADD) by **both HPA and GPA**.

In most cases, HPA for private or opaque access semantics must be specified with all HKID bits set to 0.

10 Guest-side Intel TDX functions (TDCALL leaf functions) memory operands are specified using their **guest-physical address (GPA)**.

18.2.1.4. *Memory Type*

18.2.1.4.1. *Memory Type for Private and Opaque Accesses*

The memory type for **private** and **opaque** access semantics, which use a private HKID, is WB.

15 18.2.1.4.2. *Memory Type for Shared Accesses*

Intel SDM, Vol. 3, 28.2.7.2 *Memory Type Used for Translated Guest-Physical Addresses*

The memory type for **shared** access semantics, which use a shared HKID, is determined as described below. Note that this is different from the way memory type is determined by the hardware during non-root mode operation. Rather, it is a best-effort approximation that is designed to still allow the host VMM some control over memory type.

- 20 • For **shared access during host-side (SEAMCALL) flows**, the memory type is determined by MTRRs.
- For **shared access during guest-side flows (VM exit from the guest TD)**, the memory type is determined by a combination of the Shared EPT and MTRRs.
 - If the memory type determined during Shared EPT walk is WB, then the effective memory type for the access is determined by MTRRs.
 - 25 ○ Else, the effective memory type for the access is UC.

18.2.1.5. *Actual Memory Access vs. Memory Reference*

In some cases, Intel TDX functions only **reference** memory – i.e., use its address, but no actual access is done.

In other cases, Intel TDX functions **access** the memory – i.e., perform read or write (but not execute) operations.

18.2.1.6. Summary Table

Table 18.4: Memory Access Summary

Explicit/ Implicit	Intel TDX Function	Access Semantics	Address Operand	HKID Derivation	Memory Type	Example
Explicit	Host-Side (SEAMCALL Leaf)	Shared	HPA	Derived HPA operand's HKID bits	From MTRR	SRCPAGE operand of TDH.MEM.PAGE.ADD
		Private	HPA	TD's HKID	WB	Target page of TDH.PHYMEM.PAGE.RECLAIM
			GPA	TD's HKID	WB	CHUNK operand of TDH.MR.EXTEND
			HPA and GPA	TD's HKID	WB	Target page of TDH.MEM.PAGE.ADD
	Opaque	HPA	TD's HKID or Intel TDX global HKID	WB	TDVPR operand of TDADDVPR	
	Guest-Side (TDCALL Leaf)	Shared	GPA	From Shared EPT	From Shared EPT and MTRR	REPORTDATA operand of TDG.MR.REPORT
Private		GPA	TD's HKID	WB	Target page of TDG.MEM.PAGE.ACCEPT	
Implicit	All	Private/ Opaque	N/A	TD's HKID or Intel TDX global HKID	WB	TDCS access by TDH.VP.ENTER
		Hidden	N/A	N/A	N/A	KOT access by TDH.MNG.KEY.CONFIG

18.3. UPDATED: Register Operands and CPU State Convention

- 5 Intel SDM, Vol. 3, 24.9 VM-Exit Information Fields
Intel SDM, Vol. 3, App. C VMX Basic Exit Reasons

18.3.1. Overview: Regular vs. Transition Leaf Functions

Intel TDX functions can be divided into transition functions and non-transition functions.

10 The **non-transition functions** are where SEAMCALL and TDCALL leaf functions behave as emulated CPU instructions from the perspective of the host VMM and the guest TD, respectively. In those cases, the meaning of input and output register operands is straightforward – similar to CPU instructions.

15 **Transition cases** are SEAMCALL(TDH.VP.ENTER) and TDCALL(TDG.VP.VMCALL) leaf functions, where a full cycle (until start of the next instruction) includes TD transitions to the guest TD or host VMM, respectively, and back to the host VMM or guest TD, respectively. In those cases, we look at the functions from the point of view of the caller. The meaning of input and output register operands is more complicated.

Both cases are explained in the following sections and in the function reference sections.

18.3.2. NEW: Interface Function Leaf and Version Numbers

20 Interface functions are selected by a leaf number, provided in RAX. A version number enables supporting multiple versions of the same function, if required for backward compatibility. Unless otherwise specified, the default version number is 0.

Table 18.5: Intel TDX Interface Functions Leaf and Version Numbers in RAX

Bits	Field	Description
15:0	Leaf Number	Selects the SEAMCALL or TDCALL interface function
23:16	Version Number	Selects the SEAMCALL or TDCALL interface function version
63:24	Reserved	Must be 0

18.3.3. CPU State Preservation Convention

18.3.3.1. TDH.VP.ENTER

- 5 TDH.VP.ENTER is a special case. In addition to explicit output operands discussed below, TDH.VP.ENTER is not designed to preserve the extended CPU state that the TD may use according to TDCS.XFAM.

The host VMM is expected to save any state it needs before calling TDH.VP.ENTER. Details are provided in the TDH.VP.ENTER leaf function definition (see the [TDX Module ABI Spec]).

18.3.3.2. Other Interface Functions

- 10 All Intel TDX functions except TDH.VP.ENTER are designed to preserve the CPU state not explicitly defined as output. Most interface functions preserve the AVX, AVX2 and AVX512 state. There are some exceptions, as described in the specific function definitions:

- TDG.VP.VMCALL may use some XMM registers to pass information to and from the host VMM.
- Some interface functions may reset AVX, AVX2 and AVX512 state to the architectural INIT state.

18.3.4. Transition Cases: TD Entry and Exit

18.3.4.1. TD Entry: TDH.VP.ENTER

Transfer of Host VMM State to TD Guest

- 20 By design, in the case of a TDH.VP.ENTER leaf function that follows a previous TDG.VP.VMCALL, the RCX input parameter of the previous TDG.VP.VMCALL is used as a bitmap. It selects the GPRs (from RBX, RDX, RBP, RDI, RSI and R8 through R15) and XMM registers whose value is transferred to the guest TD as-is. RAX is set to 0. See the TDG.VP.VMCALL description in the [TDX Module ABI Spec].

The rest of the CPU state is restored from the TD VCPU state as saved on TDG.VP.VMCALL.

Output State (Back to the Host VMM)

- 25 On completion of TDH.VP.ENTER, a success – indicated by the ERROR bit (RAX[63]) being 0 – means that TD Entry into the TD guest was successful. The TD guest ran for some time and then exited to the Intel TDX module. That exit can be due to execution of TDG.VP.VMCALL or due to an asynchronous exit (e.g., an EPT Violation). The Intel TDX module then executes SEAMRET, transferring control to the instruction following TDH.VP.ENTER. In this case, the DETAILS field (RAX[31:0]) format is designed to be the same as the VMX **Exit reason**.

- 30 If the completion of TDH.VP.ENTER (i.e., exit from the TD guest) was due to TDCALL(TDG.VP.VMCALL), then the RCX input parameter of TDG.VP.VMCALL is designed to be used as a bitmap. It selects the GPRs (from RBX, RDX, RBP, RDI, RSI and R8 through R15) and XMM registers whose value is passed to the host VMM as the output of TDH.VP.ENTER. RCX itself is passed as-is to the output of TDH.VP.ENTER, and RAX[31:0] indicates the **VMCALL** exit reason (see below). See the TDG.VP.VMCALL description in the [TDX Module ABI Spec].

- 35 If the completion of TDH.VP.ENTER was due to another reason, then other VMX-like Exit Information fields are provided in other GPRs. Details are provided in the TDH.VP.ENTER leaf function definition (see the [TDX Module ABI Spec]).

By design, any GPRs and extended states that do not return values as described above are set to synthetic values. If the VMM uses any of them, it must explicitly save them before TDH.VP.ENTER and restore them afterward.

18.3.4.2. TD Synchronous Exit: TDG.VP.VMCALL

Transfer of TD Guest State to Host VMM

In the case of a TDG.VP.VMCALL leaf function, the RCX input parameter of TDG.VP.VMCALL is designed to be used as a bitmap. It selects the GPRs (from RBX, RDX, RBP, RDI, RSI and R8 through R15) and XMM registers whose value is passed to the host VMM as the output of TDH.VP.ENTER. RCX itself is passed as-is to the output of TDH.VP.ENTER.

RAX provides TDH.VP.ENTER completion status (see above). All other CPU state components, including GPRs and XMM registers not selected by RCX, are saved in TDVPS and set to fixed values (see the [TDX Module ABI Spec]). The value of RCX itself is also saved to TDVPS.

Output State (Back to the Guest TD)

On completion of TDG.VP.VMCALL, a success – indicated by the ERROR bit (RAX[63]) being 0 – means that a SEAMRET into the VMM was successful. The VMM ran for some and then executed TDH.VP.ENTER successfully (possibly on another LP). The Intel TDX module executed VMRESUME successfully, transferring control to the instruction following TDCALL.

In this case, the RCX input parameter of TDG.VP.VMCALL is designed to be used as a bitmap. It selects the GPRs (from RBX, RDX, RBP, RDI, RSI and R8 through R15) and XMM registers whose value reflects their state as input to TDH.VP.ENTER. All other CPU states, including GPRs and XMM registers not selected by RCX, are restored from TDVPS.

18.4. UPDATED: Interface Function Completion Status

Intel TDX function completion status is returned in RAX. The status is structured to provide as many details to software about error conditions as practically possible. At the same time, the status enables software to ignore details that it does not need. Software may parse the completion status at three detail levels, as described below.

18.4.1. Least Detailed Level: Success/Warning/Error

At this simplest level, software can differentiate among three cases:

Table 18.6: Intel TDX Interface Functions Completion Status in RAX at the Least Detailed Level

RAX Value	Meaning	Description
0	Success	Function completed successfully
Positive (0x00000000_00000001 – 0x7FFFFFFF_FFFFFFFF)	Informational / Warning	Function completed successfully, but with some informational or warning code – e.g., TDH.PHYMEM.PAGE.RECLAIM of a TDCX page that is already not VALID
Negative (0x80000000_00000000 – 0xFFFFFFFF_FFFFFFFF)	Error	Function aborted due to some error

18.4.2. UPDATED: Medium Detailed Level: Class, Recoverability and Fatality

At this level, software can understand the following information:

Table 18.7: Intel TDX Interface Functions Completion Status in RAX at the Medium Detailed Level

Name	Description
CLASS	Class of the function completion status
ERROR	Indicates that the instruction was aborted due to error
NON_RECOVERABLE	Recoverability hint – in case of error, indicates that the error is probably not recoverable.

Name	Description
FATAL	Fatality hint – applicable only for SEAMCALL (TDH.*), indicates that the TD entered a state where it can only be torn down.
HOST_RECOVERABILITY_HINT	As a TDH.VP.ENTER output, indicates a TDCALL (TDG.*) that resulted in a trap-like TD exit for which the host VMM needs to provide a recoverability hint in the following TD entry. As a TDCALL (TDG.*) output, indicates that the host VMM provided a hint that the error is probably not recoverable.

18.4.3. UPDATED: Most Detailed Level

At this level, software can understand more details of an error that happened – e.g., if TDH.VP.ADDCX fails, software may understand if it is due to a wrong number of TDCX pages or due to the VCPU already being initialized.

- 5 Refer to the [TDX Module ABI Spec] for a detailed definition of function completion status.

18.5. NEW: TD, VM and VCPU Identification

Table 18.8: TD and VCPU Identification

Identifier	Format	Details
TD Handle	TDR HPA	While residing in memory, a TD is uniquely identifier by the TDR page HPA , serving as the TD handle input operand of TDX module host-side interface functions. TDR HPA may change when, e.g., a TD is migrated.
TD Universally Unique Identifier	256-bit integer	TD_UUID serves as a globally unique TD identifier, randomly created when the TD is created. TD_UUID survives migration.
VCPU Handle	TDVPR HPA	While residing in memory, an VCPU is uniquely identifier by the TDVPR page HPA , serving as the VCPU handle input operand of TDX module host-side interface functions. TDVPR HPA may change when, e.g., a TD is migrated.
VCPU Index	16-bit integer	A sequential VCPU index is assigned when the VCPU is created. VCPU index survives migration.
VM Index	16-bit integer	VM index identifies a VM within a TD. <ul style="list-style-type: none"> VM index 0 identifies the L1 VMM. VM indices higher than 0 identify L2 VMs.

10 18.6. UPDATED: Metadata Access Interface

18.6.1. Introduction

Metadata access interface is the architecture that allows representing TDX metadata, i.e., TD non-memory state and TDX module control state, in a way that is independent of the way it is stored. It does this by hiding the memory format of TDX control structures and allowing abstraction of data, as follows:

- 15
- The actual fields stored in the TD control structures may be different than their abstracted representation. E.g., a **TDVPS field may be provided as a GPA to TDH.VP.WR, while internally stored as an HPA.**
 - Access to a TD metadata field may **trigger some operation**. E.g., writing the TD VMCS's "posted-interrupt descriptor address" control triggers the verification of related control and may enable posted interrupt handling.
 - TD metadata fields may be completely **virtual**, i.e., there may be no actual control structure fields represented by them.
- 20

Metadata abstraction is used in the following cases:

- Read of TDX Module information by the host VMM and guest TD using the following SEAMCALL and TDCALL functions:
 - Single Field Read: TDH.SYS.RD, TDG.SYS.RD
 - All Fields Read: TDH.SYS.RDALL, TDG.SYS.RDALL
- Read and write of TDR, TDCS and TDVPS control structures by the host VMM using the following SEAMCALL functions:
 - Single Field Access: TDH.MNG.RD, TDH.MNG.WR, TDH.VP.RD, TDH.VP.WR
- Read and write of TDR, TDCS and TDVPS control structures by the guest TD using the following TDCALL functions:
 - Single Field Access: TDG.VM.RD, TDG.VM.WR, TDG.VP.RD, TDG.VP.WR
- Read and write of TDR and TDCS a service TD using the following TDCALL functions:
 - Single Field Access: TDG.SERVTD.RD, TDG.SERVTD.WR
- For **TD migration**, export and import of TD metadata by the host VMM using the following SEAMCALL functions:
 - State Export: TDH.EXPORT.STATE.IMMUTABLE, TDH.EXPORT.STATE.TD, TDH.EXPORT.STATE.VP
 - State Import: TDH.IMPORT.STATE.IMMUTABLE, TDH.IMPORT.STATE.TD, TDH.IMPORT.STATE.VP

18.6.2. Metadata Fields and Elements

Metadata fields are identified by **field identifiers (MD_FIELD_ID)**. A field identifier contains a **FIELD_CODE** and other information. A detailed description and MD_FIELD_ID values are defined in tables provided in the [TDX Module ABI Spec]. Metadata fields size may be up to 128 bytes.

For the purpose of metadata abstraction interface, fields are divided into multiple **field elements**; the size of each element can be 1, 2, 4 or 8 bytes. Elements in a field have consecutive field codes, incremented by 1 or 2 as encoded in by the field identifier's INC_SIZE.

Figure 18.1 below shows an example of a SHA384 fields (e.g., TDCS.MRCONFIGID), whose size is 48B. When access using the metadata access functions, this field is divided into six 8-byte elements.

	Element 0	Element 1	Element 2	Element 3	Element 4	Element 5
FIELD_CODE	X	X + 1	X + 2	X + 3	X + 4	X + 5
Content	Bytes 7:0	Bytes 15:8	Bytes 23:16	Bytes 31:24	Bytes 39:32	Bytes 47:40

Figure 18.1: Example of a 48 Byte TDCS.MRCONFIGID Field Composed of Six 8 Byte Elements

A detailed definition of a field identifier is provided in the [TDX Module ABI Spec].

18.6.3. Arrays of Metadata Fields

Metadata fields can be organized in arrays. Figure 18.2 below shows an example of an array of 4 fields, each composed of 1 element. In this case, fields in the array have consecutive field codes, incremented by 1 or 2 as encoded in by the field identifier's INC_SIZE field.

Array Index	Field Code	Content
0	X + 0	Array[0]
1	X + 1	Array[1]
2	X + 2	Array[2]
3	X + 3	Array[3]

Figure 18.2: Example of an Array of 4 Single-Element Fields

Figure 18.3 below shows an example where each field is composed of multiple elements. TDCS.RTMR is such a case. The base FIELD_ID of each field in the array is incremented by the number of elements in each field, multiplied by 1 or 2 as encoded in by the field identifier's INC_SIZE field.

Array Index	Base FIELD_ID	Element 0's FIELD_ID	Element 1's FIELD_ID	Element 2's FIELD_ID	Element 3's FIELD_ID	Element 4's FIELD_ID	Element 5's FIELD_ID
0	X + 0	X + 0	X + 1	X + 2	X + 3	X + 4	X + 5
1	X + 6	X + 6	X + 7	X + 8	X + 9	X + 10	X + 11
2	X + 12	X + 12	X + 13	X + 14	X + 15	X + 16	X + 17
3	X + 18	X + 18	X + 19	X + 20	X + 21	X + 22	X + 23

Figure 18.3: Example of an Array of Four 48 Byte TDCS.RTMR Fields, Each Composed of 6 Elements

18.6.4. NEW: Metadata Field Sequences

Field sequences contain one or more whole metadata fields, each composed of one or more elements. A sequence is composed of a sequence header and one or more values.

- 5 • All fields in a sequence have the same CONTEXT_CODE, CLASS_CODE and field size (i.e., the same number of elements and the same element size).
- Each element a sequence occupies 8 bytes, even if its size is 1, 2 or 4 bytes. When a sequence is used as an output of the TDX module, the upper bytes beyond the element size are zeroed out. When a sequence is used as an input of the TDX module, the upper bytes are ignored.
- 10 • The FIELD_CODEs of each element in a sequence are consecutive.
- A field sequence may contain a write mask, which applies to each element value in the sequence. This is applicable when the sequence is used for writing bit fields, e.g., VMCS execution controls.
- A sequence always contains whole fields, i.e., if a field is composed of multiple elements, the sequence contains all of them.
- 15 A **field sequence header** contains the initial field code and other information – for a detailed description see the [TDX Module ABI Spec].

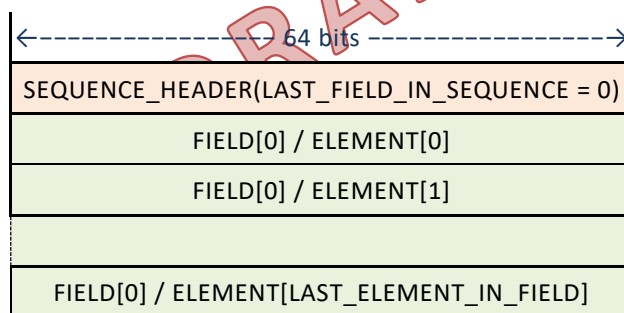

Figure 18.4: Example of a Metadata Field Sequence with One Field Composed of Multiple Elements

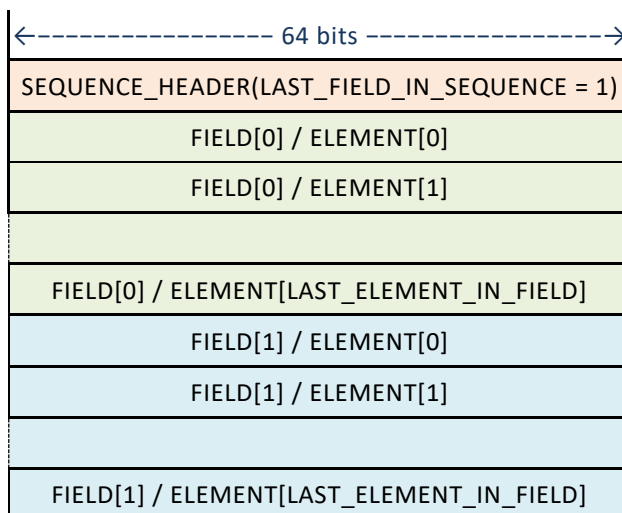

Figure 18.5: Example of a Metadata Field Sequence with 2 Fields Composed of Multiple Elements

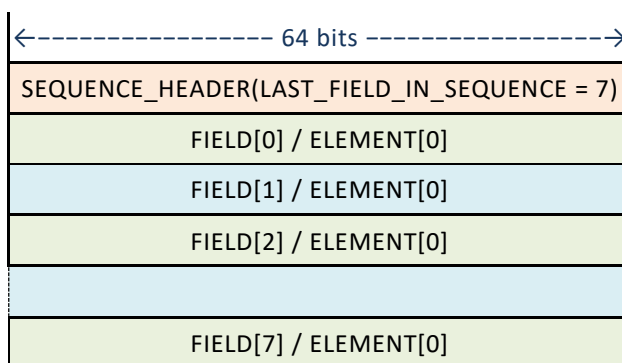

Figure 18.6: Example of a Metadata Field Sequence with 7 Fields Composed of a Single Element

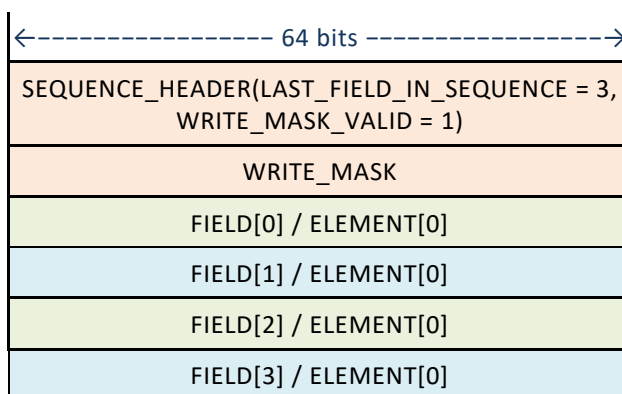

Figure 18.7: Example of a Metadata Field Sequence with a Write Mask

5

18.6.5. NEW: Metadata Lists

A metadata list is composed of a list header and one or more field sequences. The list header specifies list buffer size in bytes and the number of sequences. Metadata lists are used, e.g., for exporting VCPU metadata by THD.EXPORT.STATE.VP.

List Header	LIST_HEADER(SIZE = s, NUM_SEQUENCES = 3)
	SEQUENCE_HEADER(LAST_FIELD_IN_SEQUENCE = 2)
	FIELD[0] / ELEMENT[0]
Multi-Field Sequence	FIELD[0] / ELEMENT[1]
	FIELD[1] / ELEMENT[0]
	FIELD[1] / ELEMENT[1]
	FIELD[2] / ELEMENT[0]
	FIELD[2] / ELEMENT[1]
	FIELD[2] / ELEMENT[1]
Single-Field Sequence	SEQUENCE_HEADER(LAST_FIELD_IN_SEQUENCE = 0)
	FIELD[0] / ELEMENT[0]
	FIELD[0] / ELEMENT[1]
Multi-Field Sequence with a Write Mask	SEQUENCE_HEADER(LAST_FIELD_IN_SEQUENCE = 3, WRITE_MASK_VALID = 1)
	WRITE_MASK
	FIELD[0] / ELEMENT[0]
	FIELD[1] / ELEMENT[0]
	FIELD[2] / ELEMENT[0]
	FIELD[3] / ELEMENT[0]
	FIELD[3] / ELEMENT[0]

Figure 18.8: Metadata List Example

The metadata list header format is defined in the [TDX Module ABI Spec].

18.7. Latency of the Intel TDX Interface Functions

The Intel TDX module runs with interrupts disabled (including NMI and SMI). To support proper system responsiveness, most TDX module interface functions are designed to have a short latency. However, there are infrequent cases where the latency of some interface functions may be longer than normal, as listed below.

- Host-side interface functions that are invoked a limited number of times during TDX module lifecycle. The interface functions below are known to have longer than normal latencies:
 - TDH.SYS.INIT
 - TDH.SYS.LP.INIT
 - TDH.SYS.KEY.CONFIG
- Host-side interface functions that are invoked a limited number of times during TD . The interface functions below are known to have longer than normal latencies:
 - TDH.MNG.KEY.CONFIG
 - TDH.MNG.INIT
 - TDH.VP.INIT
- TDH.VP.ENTER may have a long latency if the single/zero step attack mitigation (described in 17.3) is activated due to a suspected attack.

18.8. DRNG Entropy Errors

Multiple TDX module interface functions may use the CPU’s digital random number generation (DRNG) facility, via the RDSEED, RDRAND and PCONFIG instructions. Such interface functions may fail on entropy errors due to the inability of the DRNG to generate random values at the requested rate, returning a TDX_RND_NO_ENTROPY or a similar status code. This may happen where, e.g., software running on other LPs in the same package also executes RDSEED at a high rate.