



February 2024 Release

# Intel® IoT Market Ready Solutions Playbook

Intel® Corporation



[Click here to learn more and see what's new](#) >

[Click here to find solutions](#) >



# Market Ready Solutions Playbook Introduction



## Purpose

This is a self-service playbook for Intel® IoT Market Ready Solutions, designed to inform Intel field sellers and Intel channel partners of the available IoT solutions. This playbook offers a one-page overview of each solution along with links to additional materials to best equip sellers in the market.

If you have any questions regarding the solutions in this playbook, please contact Matthew Cope at [Matthew.w.cope@intel.com](mailto:Matthew.w.cope@intel.com)



## Instructions for use

The Intel® Market Ready Solutions Playbook is designed for simple navigation:

- Start on the [Intel® IoT Market Ready Solutions Overview Page](#).
- From there, click the (🏠) button to access the [Intel® IoT Market Ready Solutions Home Page](#). Select a desired use case by clicking its image. This gives you access to the search for solutions ordered by primary vertical, use case, or alphabet.
- To go back and choose a different solution, click the use case image at the top of the page.
- At any time, you can click the (🏠) button in the top right to navigate back to the Intel® IoT Market Ready Solutions Home Page.



# Market Ready Solutions Overview

Every Intel® IoT Market Ready Solution Contains Five Key attributes...

1

**End-to-end solution:** Ingests data from the edge and delivers all the way to the cloud

2

**Drive analytics:** Collects and analyzes data and informs business transformation in targeted verticals

3

**Single Source:** Provides one point where users can order, install, and maintain the solution

4

**Repeatable and Scalable:** Has at least three successful commercial deployments at two unique end customers

5

**Intel inside:** Leverages one or more Intel technologies

## Value Props | Making it easier for



Customers to realize solution value

Solution partners to get solutions to market

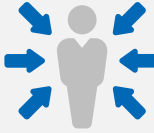

Integrators to implement solutions



# Playbook Updates – February 2024

Each month, the Intel® IoT Market Ready Solution Playbook is updated to reflect the most accurate and current information available. This includes new IoT solution overview pages as well as any updated information for existing solutions.



Below are the new solution pages for February 2024

## Updates

- [Honeywell Airport Solutions](#)
- [Honeywell City Suite Safe Cities](#)



# Choose Your Navigation Path

Explore three ways to view Intel® IoT Market Ready Solution in this playbook

See solutions  
by vertical



See solutions  
by use case



See solutions  
listed alphabetically



Solution Playbook pages are designed so users can quickly return to navigation slides. You are more likely to find similar solutions by exploring specific verticals and use cases

By clicking “See solution listed alphabetically” you can view the all up list of MRS Solutions sorted A-Z

If at any point you want to return to this slide—you can click the (🏠) icon in the top-right corner of most slides



# Intel® IoT Market Ready Solutions Verticals

Click the use cases to learn more about what solutions apply to it

Retail	Hospitality	Banking/FSI	Education
Manufacturing	Energy	Health & Life Sciences	Government
Transportation	Other	Agriculture	



# Intel® IoT Market Ready Solutions Use Cases

Click the use cases to learn more about what solutions apply to it

Machine Condition Monitoring	Control Optimization & Autonomy	Product Inspection	Asset & Operations Management
Energy Monitoring & Management	Human Wellness Monitoring	Situational Monitoring	Other
Logistics & Tracking	Interactive Media	Environmental Monitoring	



# Click the Group to See Solutions Alphabetically

Solutions alphabetized by **company name** rather than solution name

A – C

D – G

H – L

V-Z

M – O

P – S

S – U





# Retail

Click the solutions to learn more about them

## Machine Condition Monitoring

- [Crown Digital - Ella: The Robot Barista](#)
- [UST ColdTruth](#)
- [Seavo Kiosk Peripheral Management and USB Auto-Recovery](#)

## Human Wellness Monitoring

- [IntraEdge and Pyramid Janus](#)

## Other

- [NCR FastLane SelfServ Checkout](#)

## Logistics & Tracking

- [faytech AG EASY Shopper](#)
- [Hangzhou Century Co. Fashion Industry IoT Solution](#)
- [Hubz Smart Stores](#)
- [Petrosoft Cloud CStoreOffice®](#)

## Control Optimization & Autonomy

- [Invenda Interactive Vending and Advertising Platform for Retail and Hospitality](#)
- [Shandong Extreme Vision Co., Ltd. Smart Retail AI Solution](#)
- [SMRT1POD](#)
- [Super Micro Computer Inc. Retail Edge Evolution](#)



# Retail

Click the solutions to learn more about them

## Asset & Operation Optimization

- [Cloudpick Autonomous Store](#)
- [Diebold Nixdorf DN Series™ BEETLE A1150](#)
- [Fortinet Secure Branch](#)
- [inefi Spotlight](#)
- [IntraEdge Truyo](#)
- [Jian24 Smart Retail Solution](#)
- [NCR Emerald Retail Point of Sale Platform](#)
- [Tata Consultancy Services Ltd. Self-Checkout Loss Prevention Solution](#)
- [Theatro Intelligent Voice Assistant for the Frontline Workforce](#)
- [V-Sync SmartVendor](#)

- [Quanergy Flow Management](#)
- [SNS Network SDN BHD JOI Smart Classroom](#)
- [Winmore Digit-China Barcodeless Goods Identification Kit](#)
- [Wintec QINGDAO Self-Checkout Solution Enabled with Loss Prevention](#)

## Situational Monitoring

- [Awiros Video Intelligence Platform](#)
- [Expertos En Sistemas Braingine Machine Vision](#)
- [Beijing Winsense Technology Co. Ltd. Retail Store](#)
- [Digifort IP Security System Digifort Cloud](#)
- [IDIS Solution Suite and IDIS Center](#)
- [Megh Computing, Inc. VAS for Smart Buildings](#)
- [Pathr.ai Spatial Intelligence](#)
- [Sertek All-in-One AI NVR](#)
- [Shinsegae I&C Spharos Cloud POS](#)
- [UST Vision Intelligence Box](#)
- [UST Global: Retail Analytics for Covid-19 and Beyond](#)



# Retail

Click the solutions to learn more about them

## Interactive Media

- [22 Miles Interactive Video Walls](#)
- [AIRxTOUCH KIOSK Series 3](#)
- [Broox Platform](#)
- [Bütema AG Digital Signage](#)
- [ComQi Engage Platform](#)
- [CO-WIN Co., Ltd. OnlineMAW – Content Management System of Digital Signage](#)
- [Flood Solutions](#)
- [Giada Digital Signage Management](#)
- [M3T Retail Kiosk](#)
- [Ombori Apps AB Grid Compute Device](#)
- [Perch Retail Displays](#)
- [PROTO Hologram Powered by Wachter](#)
- [Pyramid Computer GmbH Self Checkout Kiosk](#)
- [Pyramid Computer Magic Mirror](#)
- [ScreenVend Digital Retailing Solution](#)
- [Shenzhen SED Initta Intelligent POS Solution](#)
- [Sindrax Technology Interactive Multimedia Sports Game](#)
- [Skratch & ANQ Phygital Video Wall](#)
- [Smart Board Interactive Display with Smart Ops PC](#)
- [TELELOGOS Media4Display](#)
- [Toshiba Self Service Retail Total Solutions](#)
- [Toshiba TCxTM 800 All-In-One POS and Remote Monitoring In-Store Experience](#)
- [TouchSource Digital Directory Experience](#)
- [Trison signage.ninja](#)
- [Trueform Indoor and Outdoor Digital Advertising Displays](#)
- [UST Vision Checkout Kiosk](#)
- [ViewSonic ViewBoard](#)

## Product Inspection

- [Mashgin Touchless Checkout System](#)



# Manufacturing

Click the solutions to learn more about them

## Control Optimization & Autonomy

- [Adapdix EdgeOps](#)
- [Geek+ AI AMR Edge Cloud Smart Logistics Solution](#)
- [ForwardX Robotics Visual Autonomous Mobile Robots](#)
- [Shandong Extreme Vision Co., Ltd. Smart Community AI Solution](#)
- [Shandong Extreme Vision Co., Ltd. Smart Factory AI Solution](#)
- [Supermicro Industry 4.0 Evolving](#)
- [Supermicro Intelligent Secure Edge](#)
- [Wuxi Xinje Vision Guided Intelligent Welding System](#)
- [WPI Group SMT Intelligent Smart Storage Rack Solution](#)
- [Xesol Drivox](#)
- [Xinje Electric X-SIGHT: Intelligent Industrial Controller](#)

## Energy Monitoring & Management

- [Advantech WISE-FactoryEHS](#)
- [The Hark Platform](#)

## Situational Monitoring

- [AIBDT Analysis Decision Platform](#)
- [AIRA Corporation airaTrack](#)
- [Hikrobot: iWarehouse Intelligent Management Warehouse](#)
- [Industrial Network Security with Monitor for secunet edge](#)
- [Staqu Technologies JARVIS For Manufacturing](#)
- [Touch Cloud/WPI TC Telescope](#)
- [Wobot Hygiene and Safety Module](#)
- [Wincomm Corporation Smart Hygiene Control Solutions](#)

## Asset & Operations Optimization

- [BirminD B-Wise B-Cloud AutoML](#)
- [Dot Zero Connect ZPS](#)
- [Ectron Corporation SmartEYE™ Intelligent Edge Node](#)
- [Eigen Machine Vision](#)
- [Extra Computer GmbH Calmo IOT Terminal for Manufacturing and POS](#)
- [iProd MOP Manufacturing Optimisation Platform](#)
- [OnLogic – Ignition SCADA Solution](#)
- [Sewio Real-Time Location System](#)
- [Share Tech Information OT Security Solution](#)
- [Supermicro Smart Digitalized Production Process Enhances Quality Control](#)
- [Touch Cloud Inc. Portable Smart Construction Site Surveillance and Event Detection System](#)
- [TTTech Industrial Nerve Blue](#)



# Manufacturing

Click the solutions to learn more about them

## Product Inspection

- [Advantech Equipment Vibration Monitoring](#)
- [Matrox Imaging Manufacturing Machine Vision Solution](#)
- [MegAAOI Spring Probe AOI Machine](#)
- [Microvision Machine Vision Kit for Smart Manufacturing](#)
- [MiTAC Machine Vision in Factory Automation](#)
- [MVISIA Desenvolvimentos Inovadores S.A MVISIA WEG CVU](#)
- [Ponfac Count](#)
- [Qualitas Technologies EagleEye Platform](#)
- [Relimetrics AI-Based QA Automation System for Electronics Assembly](#)
- [Tvarit Industrial AI Solution](#)
- [Vecow Surface Defect Inspection Solution](#)

## Machine Condition Monitoring

- [CANCOM Smart Product](#)
- [Digital China iSESOL Intelligent Manufacturing Solution](#)
- [ORISOL Production Data Collection System \(PDCS\)](#)
- [Sophic Automation Sdn Bhd Manufacturing Lights Off](#)
- [Synnex Technology International - Smart MES for Factory](#)
- [Tata Consultancy Services TCS Equiptix](#)
- [Vecow Co., Ltd. Machine to Machine Solution](#)
- [Yoi System Co., Ltd. i-X \(i-ECS: Intelligent-Edge Control System\)](#)

## Interactive Media

- [Clevertouch Interactive Communication and Collaboration Solution](#)

## Logistics & Tracking

- [AI-Powered Logistic Solution – Alfabet](#)
- [Vecow Sterilization AMR](#)
- [Digital China – Warehousing Business Automation and Visualization of Management Process Solution](#)

## Environmental Monitoring

- [Panasonic ArgosView](#)

## Human Wellness Monitoring

- [AIRA Corporation airaFACE](#)



# Transportation

Click the solutions to learn more about them

## Asset & Operation Optimization

- [Beijing Sinoits Xiaoshentong Toll Vehicle Identification and Management Solution Based on Intel Architecture](#)
- [Disrupt-X Cognitive Neurons](#)
- [Exosite ExoSense Condition Monitoring Solution](#)
- [Passenger Fleet Connectivity and Infotainment Solution](#)
- [PerfectTron Level 4 Autonomous Shuttle](#)
- [RF Controls Overhead CS Smart Antennas for Battery-Free RFID Based Real-Time Location](#)
- [Touch Cloud Abaci – The Realtime Flow and Crowd Counting Solution](#)

## Situational Monitoring

- [Cisco Smart Aviation and Airports](#)
- [iOmniscient Pty Ltd IQ Roads](#)
- [Shandong Extreme Vision Smart Traffic Violation Review Solution](#)
- [Shenzhen Extreme Vision Intelligent Security Check](#)
- [7 StarLake 5G C-V2X Smart Traffic](#)
- [Uncanny Vision Uncanny Gate ANPR](#)
- [Videonetics Intelligent Video Management Software](#)

## Logistics & Tracking

- [Shenzhen JHCTECH Road Pricing Inspection System](#)
- [Touch Cloud AI@Sense LPRS](#)

## Interactive Media

- [22Miles Interactive Wayfinding Kiosk](#)
- [Omnivex Moxie Digital Signage](#)



# Banking/FSI

Click the solutions to learn more about them

## Situational Monitoring

- [Bits & Bytes Thermal Detection Kiosk](#)
- [VisionLabs LUNA PLATFORM](#)

## Interactive Media

- [Avocor All-In-One Interactive Display with Intel® OPS](#)
- [Exerity Digital Signage and IP Video Solution](#)
- [Centerm Smart Banking Solutions](#)
- [PT. Murni Solusindo Nusantara AI Powered Digital Public Information Display](#)

## Asset & Operations Optimization

- [DN AllConnectSM Data Engine for Data-Driven Intelligence Powering Actionable Insights](#)



# Hospitality

Click the solutions to learn more about them

## Interactive Media

- [Partner Tech Smart Hotel Self-Service KIOSK](#)
- [Prox Systems Co., Ltd. Restaurant Smart Service Solution](#)
- [Pyramid Computer Restaurant Ordering Kiosk](#)
- [Yanolja Y FLUX Kiosk Smart Hotel Lobby](#)

## Asset & Operations Optimization

- [Autocanteen Self-Service](#)
- [Berry AI, Inc. AI-based Timer System](#)
- [PreciTaste Prep Assistant](#)
- [NTT System System Blue Bolt](#)
- [Sertek EZcon Smart Building System](#)
- [Shandong Extreme Vision Open Kitchen Solution](#)
- [UdyogYantra Technologies Food Quality and Quantity Authentication](#)

## Human Wellness Monitoring

- [Elenium HealthGate Touchless Control anVital Sign Detection](#)

## Control Optimization & Autonomy

- [AiMall Virtual Store Supervisor](#)

## Situational Monitoring

- [V-Series Drive-Thru Analytics Solution for Quick Service Restaurants \(QSR\)](#)





# Health & Life Sciences

Click the solutions to learn more about them

## Human Wellness Monitoring

- [Ambient Clinical Analytics Aware Family](#)
- [Biomedica DataSense](#)
- [Biomedica Osteoporosis Screening Kit](#)
- [diagnext.com Diagserver Medical](#)
- [Digital Barriers Heat Detection Camera](#)
- [GE Healthcare Edison](#)
- [Imedtac iVMS Intelligent Vital Signs Station](#)
- [JelloX Biotech Inc. MetaLite® Digital Pathology Edge Solution](#)

- [LACHESIS Mhealth 5G Smart Ward Solution](#)
- [MIC's Sickbay™ Platform](#)
- [MITIS Health Lossless Remote Radiology & Pathology Home Reporting](#)
- [Ocuvera Fall Prediction & Monitoring](#)
- [Teladoc Health TV Pro](#)
- [Vecow VHub AI Fever Scan Solution](#)
- [VeeMed TeleHealth Care Delivery](#)
- [Wachter Healthcare NOVA](#)
- [WiCis Health 3.0](#)
- [Wincomm Corporation Smart EMR Solution for e-Healthcare](#)

## Logistics & Tracking

- [Pyramid Computer Essentry Visitor Verification](#)



# Health & Life Sciences

Click the solutions to learn more about them

## Interactive Media

- [Mingtech Intelligent Medical Payment Platform](#)
- [Olea Kiosks Inc. Healthcare Check-in Kiosk](#)
- [Runkong Smart Hospital Kiosk](#)
- [Zhejiang Jandar Technology Wise Medical Treatment](#)

## Situational Monitoring

- [Qisda ER Dashboard AIoT Information Platform](#)

## Product Inspection

- [HY Medical AI-Assisted Diagnosis of Medical Imaging on IA Solution](#)
- [Novarad Imaging Suite: Enterprise Imaging Management System, AR Surgical Guidance, and Image Sharing](#)
- [ZRT Intelligent Medical Image Review and Consultation](#)
- [Qisda ER Dashboard AIoT Information Platform](#)

## Asset & Operations Optimization

- [HOOBOX Robotics Neonpass](#)
- [Medigate Device Security Platform Powered by Dell and VMWare](#)
- [Onyx Intelligent Healthcare Interoperability Platform \(iHIP\)](#)
- [Vesystem Cloud Terminal Healthcare Solution](#)
- [Wincomm Corporation Smart EMR Solution for e-Healthcare](#)



# Energy

Click the solutions to learn more about them

## Situational Monitoring

- [SSE Mayflower Insite Sentinel](#)
- [Systems with Intelligence Visual/Thermal Asset Monitoring System](#)

## Environmental Monitoring

- [Axians IoT Operations Green Edge](#)

## Asset & Operations Optimization

- [Cisco Smart Buildings](#)
- [Dell Grid Management Platform for Schneider Electric EcoStruxure™ ADMS Applications](#)
- [RonPos - OnPrem Manageability System for Fuel Convenience Stores](#)

## Other

- [Q-Net Security – Cybersecurity Hardware Solutions](#)
- [DOTS Smart Energy Services](#)

## Energy Monitoring & Management

- [HuaDian Intelligent Energy Management](#)
- [InSynerger Power Efficiency & Electrical Safety Management Solution](#)
- [Onesait Active Grid Management Suite](#)



# Government

Click the solutions to learn more about them

## Situational Monitoring

- [AllGoVision – AI Powered Video Analytics](#)
- [beamLive, Inc. – Unified Mobile IoT Communication](#)
- [Corsight AI Fortify](#)
- [Deep Insights](#)
- [GeoVision Smart End-to-End Video](#)
- [Getac Video Solutions](#)
- [Honeywell City Suite Safe Cities](#)
- [Innodep VURIX](#)
- [Intelligent Security Systems – SecurOSFACEx](#)
- [Jovision Technology Smart Community Solution](#)
- [Mirasys Women Safety Solution](#)
- [Pegatron 5G Private Network Solution: Digital Resilience](#)
- [ST Engineering AGIL Smart Car Park Suite](#)
- [Seavo Real-Time Face Recognition Gate Access Control](#)

- [TD Synnex Mobile Connected First Responder](#)
- [Telesoft TDAC](#)
- [TITANUSEYEoT DSS](#)
- [Vaelsys V4](#)
- [Vehant Technologies TrafScan® Vehicle Detection System](#)

## Asset & Operations Optimization

- [Graymatics AI Driven Advanced Video Analytics](#)
- [Honeywell Airport Solutions](#)
- [Indra Sistemas Onesait Sustainability Waste Citizen](#)
- [PMY Group Venues Facility and Transportation Optimization](#)

## Interactive Media

- [LG-MRI BoldVu® Kiosks](#)
- [Grupo MSA – Electronic Ballot System \(EBS\) by vot.ar](#)

## Environmental Monitoring

- [Disrupt-X Ignite Shield](#)
- [Shenzhen Genew Intelligent Technology Multifunctional Smart LightPoles](#)

## Control Optimization & Autonomy

- [ISSD Electronics SPECTO™ Incident Detection System](#)
- [NEC SDM Integrated ECO-System](#)
- [Widya Robotics Intelligent Gate](#)



# Government

---

Click the solutions to learn more about them

Human Wellness  
Monitoring

Logistics & Tracking

- [OnLogic Singlewire](#)  
[InformaCast Fusion Server](#)

Other

- [Phonexia Speech Platform](#)



# Education

Click the solutions to learn more about them

## Asset & Operations Optimization

- [Centerm Weixun Intelligent Cloud Solution for School District](#)
- [Prowise Full Solution for Education](#)

## Situational Monitoring

- [CathexisVision – Video Security Management Solution](#)

## Human Wellness Monitoring

- [OnLogic ThingLogix Workwatch](#)

## Interactive Media

- [CVTE MAXHUB](#)
- [HiteVision Interactive Classroom Broadcasting Solution](#)
- [i3-Technologies Hybrid Teaching](#)
- [JWIPC iLearn Remote Class Interactive](#)
- [Nanjing Mythware Information Technology Mythware Smart Classroom](#)
- [Schoolnet India Limited K-Class Powered by K-Yan](#)
- [Sindrax Intelligent Gamified Kids \(Pre-school\) Education System](#)
- [WolfVision Cynap Pure](#)



# Other

Click the solutions to learn more about them

## Situational Monitoring

- [Axis Camera Station S-Series Network Video Recorders](#)

## Interactive Media

- [22Miles Visual Communications](#)
- [BenQ DuoBoard Corporate Interactive Display](#)
- [Cisco IP Fabric for Media](#)
- [Crestron Collaboration Solution Refresh](#)
- [Olea Kiosks Inc. Ticketing and Booking Kiosks](#)
- [ViewSonic Wireless Collaboration Display](#)

## Asset & Operations Optimization

- [GDDi Algorithms Defined Edge AIBox Based on Intel® Series Chips](#)
- [Prescriptive Data NANTUM](#)
- [Wipro Limited Digital Twin for Smart Buildings](#)
- [Wipro Limited Edge Device Management for OT and IoT](#)
- [Wipro Limited Smart i-Building](#)

## Environmental Monitoring



# Agriculture

---

Click the solutions to learn more about them





# Product Inspection

Click the solutions to learn more about them

## Manufacturing

- [Advantech Equipment Vibration Monitoring](#)
- [Matrox Imaging Manufacturing Machine Vision Solution](#)
- [MegAAOI Spring Probe AOI Machine](#)
- [MiTAC Machine Vision in Factory Automation](#)
- [Microvision Machine Vision Kit for Smart Manufacturing](#)
- [MVISIA Desenvolvidos Inovadores S.A MVISIA WEG CVU](#)
- [Ponfac Count](#)
- [Relimetrics AI-Based QA Automation System for Electronics Assembly](#)
- [Tvarit Industrial AI Solution](#)

- [Qualitas Technologies EagleEye Platform](#)
- [Vecow Surface Defect Inspection Solution](#)

## Health & Life Sciences

- [HY Medical AI-Assisted Diagnosis of Medical Imaging on IA Solution](#)
- [Novarad Imaging Suite: Enterprise Imaging Management System, AR Surgical Guidance, and Image Sharing](#)
- [ZRT Intelligent Medical Image Review and Consultation](#)

## Retail

- [Mashgin Touchless Checkout System](#)



# Machine Condition Monitoring

Click the solutions to learn more about them

## Manufacturing

- [CANCOM Smart Product](#)
- [Digital China iSESOL Intelligent Manufacturing Solution](#)
- [ORISOL Production Data Collection System \(PDCS\)](#)
- [Sophic Automation Sdn Bhd Manufacturing Lights Off](#)
- [Synnex Technology International - Smart MES for Factory](#)
- [Tata Consultancy Services TCS Euptix](#)
- [Vecow Co., Ltd. Machine to Machine Solution](#)
- [Yoi System Co., Ltd. i-X \(i-ECS: Intelligent-Edge Control System\)](#)

## Retail

- [Crown Digital - Ella: The Robot Barista](#)
- [Seavo Kiosk Peripheral Management and USB Auto-Recovery](#)
- [UST ColdTruth](#)



# Situational Monitoring

Click the solutions to learn more about them

## Government

- [AllGoVision – AI Powered Video Analytics](#)
- [beamLive, Inc. – Unified Mobile IoT Communication](#)
- [Corsight AI Fortify](#)
- [Deep Insights](#)
- [GeoVision Smart End-to-End Video](#)
- [Getac Video Solutions](#)
- [Honeywell City Suite Safe Cities](#)
- [Innodep VURIX](#)
- [Intelligent Security Systems – SecurOSFACEx](#)

- [Jovision Technology Smart Community Solution](#)
- [Mirasys Women Safety Solution](#)
- [Pegatron 5G Private Network Solution: Digital Resilience](#)
- [ST Engineering AGIL Smart Car Park Suite](#)
- [Seavo Real-Time Face Recognition Gate Access Control](#)
- [TD Synnex Mobile Connected First Responder](#)
- [Telesoft TDAC](#)
- [TITANUS EYEoT DSS](#)
- [Vaelsys V4](#)
- [Vehant Technologies TrafScan® Vehicle Detection System](#)

## Health & Life Sciences

- [Qisda ER Dashboard AIoT Information Platform](#)

## Energy

- [SSE Mayflower Insite Sentinel](#)
- [Systems with Intelligence Visual/Thermal Asset Monitoring System](#)

## Banking/FSI

- [Bits & Bytes Thermal Detection Kiosk](#)
- [VisionLabs LUNA PLATFORM](#)

## Education

- [CathexisVision – Video Security Management Solution](#)



# Situational Monitoring

Click the solutions to learn more about them

## Transportation

- [Cisco Smart Aviation and Airports](#)
- [iOmniscient Pty Ltd IQ Roads](#)
- [Shandong Extreme Vision Smart Traffic Violation Review Solution](#)
- [7 StarLake 5G C-V2X Smart Traffic](#)
- [Shenzhen Extreme Vision Intelligent Security Check](#)
- [Uncanny Vision Uncanny Gate ANPR](#)
- [Videonetics Intelligent Video Management Software](#)

## Other

- [Axis Camera Station S-Series Network Video Recorders](#)

## Manufacturing

- [AIBDT Analysis Decision Platform](#)
- [AIRA Corporation airTrack](#)
- [Hikrobot: iWarehouse Intelligent Management Warehouse](#)
- [Industrial Network Security with Monitor for secunet edge](#)
- [Staqu Technologies JARVIS For Manufacturing](#)
- [Touch Cloud/WPI TC Telescope](#)
- [Wincomm Corporation Smart Hygiene Control Solutions](#)
- [Wobot Hygiene and Safety Module](#)

## Hospitality

- [V-Series Drive-Thru Analytics Solution for Quick Service Restaurants \(QSR\)](#)

## Retail

- [Awiros Video Intelligence Platform](#)
- [Beijing Winsense Technology Co. Ltd. Retail Store](#)
- [Digifort IP Security System Digifort Cloud](#)
- [Expertos En Sistemas Braingine Machine Vision](#)
- [IDIS Solution Suite and IDIS Center](#)
- [Megh Computing, Inc. VAS for Smart Buildings](#)
- [Pathr.ai Spatial Intelligence](#)
- [Sertek All-in-One AI NVR](#)
- [Shinsegae I&C Spharos Cloud POS](#)
- [UST Vision Intelligence Box](#)
- [UST Global: Retail Analytics for Covid-19 and Beyond](#)



# Interactive Media

Click the solutions to learn more about them

## Health & Life Sciences

- [Mingtech Intelligent Medical Payment Platform](#)
- [Olea Kiosks Inc. Healthcare Check-in Kiosk](#)
- [Runkong Smart Hospital Kiosk](#)
- [Zhejiang Jandar Technology Wise Medical Treatment](#)

## Transportation

- [22Miles Interactive Wayfinding Kiosk](#)
- [Omnivex Moxie Digital Signage](#)

## Education

- [CVTE MAXHUB](#)
- [HiteVision Interactive Classroom Broadcasting Solution](#)
- [i3-Technologies Hybrid Teaching](#)
- [JWIPC iLearn Remote Class Interactive](#)
- [Nanjing Mythware Information Technology Mythware Smart Classroom](#)
- [Schoolnet India Limited K-Class Powered by K-Yan](#)
- [Sindrax Intelligent Gamified Kids \(Pre-school\) Education System](#)
- [WolfVision Cynap Pure](#)

## Government

- [Grupo MSA – Electronic Ballot System \(EBS\) by vot.ar](#)
- [LG-MRI BoldVu® Kiosks](#)

## Hospitality

- [Partner Tech Smart Hotel Self-Service KIOSK](#)
- [Prox Systems Co., Ltd. Restaurant Smart Service Solution](#)
- [Pyramid Computer Restaurant Ordering Kiosk](#)
- [Yanolja Y FLUX Kiosk Smart Hotel Lobby](#)



# Interactive Media

Click the solutions to learn more about them

## Other

- [22Miles Visual Communications](#)
- [BenQ DuoBoard Corporate Interactive Display](#)
- [Cisco IP Fabric for Media](#)
- [Crestron Collaboration Solution Refresh](#)
- [Olea Kiosks Inc. Ticketing and Booking Kiosks](#)
- [ViewSonic Wireless Collaboration Display](#)

## Banking/FSI

- [Avocor All-In-One Interactive Display with Intel® OPS](#)
- [Exterity Digital Signage and IP Video Solution](#)
- [Centerm Smart Banking Solutions](#)
- [PT. Murni Solusindo Nusantara AI Powered Digital Public Information Display](#)

## Retail

- [22 Miles Interactive Video Walls](#)
- [AIRxTOUCHKIOSK Series 3](#)
- [Broox Platform](#)
- [Bütema AG Digital Signage](#)
- [ComQi Engage Platform](#)
- [CO-WIN Co., Ltd. OnlineMAW – Content Management System of Digital Signage](#)
- [Flood Solutions](#)
- [Giada Digital Signage Management](#)
- [M3T Retail Kiosk](#)
- [Ombori Apps AB Grid Compute Device](#)
- [Perch Retail Displays](#)
- [PROTO Hologram Powered by Wachter](#)
- [Pyramid Computer GmbH Self Checkout Kiosk](#)
- [Pyramid Computer Magic Mirror](#)
- [ScreenVend Digital Retailing Solution](#)
- [Shenzhen SED Initta Intelligent POS Solution](#)
- [Sindrax Technology Interactive Multimedia Sports Game](#)

- [Skratch & ANQ Phygital Video Wall](#)
- [Smart Board Interactive Display with Smart Ops PC](#)
- [Toshiba Self Service Retail Total Solutions](#)
- [Toshiba TCxTM 800 All-In-One POS and Remote Monitoring In-Store Experience](#)
- [TouchSource Digital Directory Experience](#)
- [Trison signage.ninja](#)
- [Trueform Indoor and Outdoor Digital Advertising Displays](#)
- [TELELOGOS Media4Display](#)
- [UST Vision Checkout Kiosk](#)
- [ViewSonic ViewBoard](#)

## Manufacturing

- [Clevertouch Interactive Communication and Collaboration Solution](#)



# Logistics & Tracking

Click the solutions to learn more about them

## Retail

- [faytech AG EASY Shopper](#)
- [Hangzhou Century Co. Fashion Industry IoT Solution](#)
- [Hubz Smart Stores](#)
- [Petrosoft Cloud CStoreOffice®](#)

## Manufacturing

- [AI-Powered Logistic Solution – Alfabeta](#)
- [Vecow Sterilization AMR](#)
- [Digital China – Warehousing Business Automation and Visualization of Management Process Solution](#)

## Transportation

- [Shenzhen JHCTECH Road Pricing Inspection System](#)
- [Touch Cloud AI@Sense LPRS](#)

## Health & Life Sciences

- [Pyramid Computer Essentry Visitor Verification](#)

## Government

- [OnLogic Singlewire InformaCast Fusion Server](#)



# Control Optimization & Autonomy

Click the solutions to learn more about them

## Manufacturing

- [Adapdix EdgeOps](#)
- [ForwardX Robotics Visual Autonomous Mobile Robots](#)
- [Geek+ AI AMR Edge Cloud Smart Logistics Solution](#)
- [Shandong Extreme Vision Co., Ltd. Smart Community AI Solution](#)
- [Shandong Extreme Vision Co., Ltd. Smart Factory AI Solution](#)
- [Supermicro Industry 4.0 Evolving](#)
- [Supermicro Intelligent Secure Edge](#)
- [WPI Group SMT Intelligent Smart Storage Rack Solution](#)
- [Wuxi Xinje Vision Guided Intelligent Welding System](#)
- [Xesol Drivox](#)
- [Xinje Electric X-SIGHT: Intelligent Industrial Controller](#)

## Government

- [ISSD Electronics SPECTO™ Incident Detection System](#)
- [NEC SDM Integrated ECO-System](#)
- [Widya Robotics Intelligent Gate](#)

## Hospitality

- [AiMall Virtual Store Supervisor](#)

## Retail

- [Invenda Interactive Vending and Advertising Platform for Retail and Hospitality](#)
- [Shandong Extreme Vision Co., Ltd. Smart Retail AI Solution](#)
- [SMRT1 POD](#)
- [Super Micro Computer Inc. Retail Edge Evolution](#)





# Asset & Operations Optimization

Click the solutions to learn more about them

## Transportation

- [Beijing Sinoits Xiaoshentong Toll Vehicle Identification and Management Solution Based on Intel Architecture](#)
- [Disrupt-X Cognitive Neurons](#)
- [Exosite ExoSense Condition Monitoring Solution](#)
- [Passenger Fleet Connectivity and Infotainment Solution](#)
- [PerfecTron Level 4 Autonomous Shuttle](#)
- [RF Controls Overhead CS Smart Antennas for Battery-Free RFID Based Real-Time Location](#)
- [Touch Cloud Abaci – The Realtime Flow and Crowd Counting Solution](#)

## Retail

- [Cloudpick Autonomous Store](#)
- [Diebold Nixdorf DN Series™ BEETLE A1150](#)
- [Fortinet Secure Branch](#)
- [inefi Spotlight](#)
- [IntraEdge Truyo](#)
- [Jian24 Smart Retail Solution](#)
- [NCR Emerald Retail Point of Sale Platform](#)
- [Quanergy Flow Management](#)
- [SNS Network SDN BHD JOI Smart Classroom](#)
- [Tata Consultancy Services Ltd. Self-Checkout Loss Prevention Solution](#)
- [Theatro Intelligent Voice Assistant for the Frontline Workforce](#)
- [V-Sync SmartVendor](#)
- [Winmore Digit-China Barcodeless Goods Identification Kit](#)
- [Wintec QINGDAO Self-Checkout Solution Enabled with Loss Prevention](#)

## Government

- [Graymatics AI Driven Advanced Video Analytics](#)
- [Honeywell Airport Solutions](#)
- [Indra Sistemas Onesait Sustainability Waste Citizen](#)
- [PMY Group Venues Facility and Transportation Optimization](#)

## Health & Life Sciences

- [HOOBOX Robotics Neonpass](#)
- [Medigate Device Security Platform Powered by Dell and VMWare](#)
- [Onyx Intelligent Healthcare Interoperability Platform \(iHIP\)](#)
- [Vesystem Cloud Terminal Healthcare Solution](#)
- [Wincomm Corporation Smart EMR Solution for e-Healthcare](#)



# Asset & Operations Optimization

Click the solutions to learn more about them

## Education

- [Centerm Weixun Intelligent Cloud Solution for School District](#)
- [Prowise Full Solution for Education](#)

## Other

- [GDDi Algorithms Defined Edge AIBox Based on Intel® Series Chips](#)
- [Prescriptive Data NANTUM](#)
- [Wipro Limited Digital Twin for Smart Buildings](#)
- [Wipro Limited Edge Device Management for OT and IoT](#)
- [Wipro Limited Smart i-Building](#)

## Banking/FSI

- [DN AllConnectSM Data Engine for Data-Driven Intelligence Powering Actionable Insights](#)

## Manufacturing

- [BirminDB-Wise B-Cloud AutoML](#)
- [Dot Zero Connect ZPS](#)
- [Ectron Corporation SmartEYE™ Intelligent Edge Node](#)
- [Eigen Machine Vision](#)
- [Extra Computer GmbH Calmo IOT Terminal for Manufacturing and POS](#)
- [iProd MOP Manufacturing Optimisation Platform](#)
- [OnLogic – Ignition SCADA Solution](#)
- [Sewio Real-Time Location System](#)
- [ShareTech Information OT Security Solution](#)
- [Supermicro Smart Digitalized Production Process Enhances Quality Control](#)
- [Touch Cloud Inc. Portable Smart Construction Site Surveillance and Event Detection System](#)
- [TTTech Industrial Nerve Blue](#)

## Energy

- [Cisco Smart Buildings](#)
- [Dell Grid Management Platform for Schneider Electric EcoStruxure™ ADMS Applications](#)
- [RonPos - OnPrem Manageability System for Fuel Convenience Stores](#)

## Hospitality

- [Autocanteen Self-Service](#)
- [Berry AI, Inc. AI-based Timer System](#)
- [NTT System System Blue Bolt](#)
- [PreciTaste Prep Assistant](#)
- [Sertek EZcon Smart Building System](#)
- [Shandong Extreme Vision Open Kitchen Solution](#)
- [UdyogYantra Technologies Food Quality and Quantity Authentication](#)



# Human Wellness Monitoring

Click the solutions to learn more about them

## Health & Life Sciences

- [Ambient Clinical Analytics Aware Family](#)
- [Biomedica DataSense](#)
- [Biomedica Osteoporosis Screening Kit](#)
- [diagnext.com Diagserver Medical Communication System](#)
- [Digital Barriers Heat Detection Camera](#)
- [GE Healthcare Edison](#)
- [Imedtac iVMS Intelligent Vital Signs Station](#)
- [JelloX Biotech Inc. MetaLite® Digital Pathology Edge Solution](#)

- [LACHESIS Mhealth 5G Smart Ward Solution](#)
- [MIC's Sickbay™ Platform](#)
- [MITIS Health Lossless Remote Radiology & Pathology Home Reporting](#)
- [Ocuvera Fall Prediction & Monitoring](#)
- [Teladoc Health TV Pro](#)
- [Vecow VHub AI Fever Scan Solution](#)
- [VeeMed TeleHealth Care Delivery](#)
- [Wachter Healthcare NOVA](#)
- [WiCis Health 3.0](#)

## Manufacturing

- [AIRA Corporation airaFACE](#)

## Retail

- [IntraEdge and Pyramid Janus](#)

## Education

- [OnLogic ThingLogix Workwatch](#)

## Hospitality

- [Elenium HealthGate Touchless Control and Vital Sign Detection](#)

## Government



# Energy Monitoring & Management

Click the solutions to learn more about them

## Energy

- [HuaDian Intelligent Energy Management](#)
- [InSynerger Power Efficiency & Electrical Safety Management Solution](#)
- [Onesait Active Grid Management Suite](#)

## Manufacturing

- [Advantech WISE-FactoryEHS](#)
- [The Hark Platform](#)



# Environmental Monitoring

Click the solutions to learn more about them

## Energy

- [Axians IoT Operations Green Edge](#)

## Manufacturing

- [Panasonic ArgosView](#)

## Government

- [Disrupt-X Ignite Shield](#)
- [Shenzhen Genew Intelligent Technology Multifunctional Smart LightPoles](#)

## Other



# Other

Click the solutions to learn more about them

## Energy

- [DOTS Smart Energy Services](#)
- [Q-Net Security – Cybersecurity Hardware Solutions](#)

## Government

- [Phonexia Speech Platform](#)

## Retail

- [NCR FastLane SelfServ Checkout](#)



# Solutions from A-C

Click the solutions to learn more about them

## #

- [22 Miles Interactive Video Walls](#)
- [22Miles Interactive Wayfinding Kiosk](#)
- [22Miles Visual Communications](#)

## A

- [Adapdix EdgeOps](#)
- [Advantech Equipment Vibration Monitoring](#)
- [Advantech WISE-FactoryEHS](#)
- [AIBDT Analysis Decision Platform](#)
- [AiMall Virtual Store Supervisor](#)
- [AIRA Corporation airTrack](#)
- [AIRA Corporation airAFACE](#)
- [AI-Powered Logistic Solution – Alfabeta](#)
- [AIRxTOUCH KIOSK Series 3](#)
- [AllGoVision – AI Powered Video Analytics](#)
- [Ambient Clinical Analytics Aware Family](#)
- [Autocanteen Self-Service](#)
- [Avocor All-In-One Interactive Display with Intel® OPS](#)

- [Awiros Video Intelligence Platform](#)
- [Axians IoT Operations Green Edge](#)
- [Axis Camera Station S-Series Network Video Recorders](#)

## B

- [beamLive, Inc. – Unified Mobile IoT Communication](#)
- [Beijing Sinoits Xiaoshentong Toll Vehicle Identification and Management Solution Based on Intel Architecture](#)
- [Beijing Winsense Technology Co. Ltd. Retail Store](#)
- [BenQ DuoBoard Corporate Interactive Display](#)
- [Berry AI, Inc. AI-based Timer System](#)
- [Biomedica DataSense](#)
- [Biomedica Osteoporosis Screening Kit](#)
- [BirminDB-Wise B-Cloud AutoML](#)
- [Bits & Bytes Thermal Detection Kiosk](#)
- [Broox Platform](#)
- [Bütema AG Digital Signage](#)

## C

- [CANCOM Smart Product](#)
- [CathexisVision – Video Security Management Solution](#)
- [Centerm Smart Banking Solutions](#)
- [Centerm Weixun Intelligent Cloud Solution for School District](#)
- [Cisco IP Fabric for Media](#)
- [Cisco Smart Aviation and Airports](#)
- [Cisco Smart Buildings](#)
- [Clevertouch Interactive Communication and Collaboration Solution](#)
- [Cloudpick Autonomous Store](#)
- [ComQi Engage Platform](#)
- [Corsight AI Fortify](#)
- [CO-WIN Co., Ltd. OnlineMAW – Content Management System of Digital Signage](#)
- [Crestron Collaboration Solution Refresh](#)
- [Crown Digital - Ella: The Robot Barista](#)
- [CVTE MAXHUB](#)



# Solutions from D-G

Click the solutions to learn more about them

## D

- [Deep Insights](#)
- [Dell Grid Management Platform for Schneider Electric EcoStruxure™ ADMS Applications](#)
- [diagnext.com Diagserver Medical Communication System](#)
- [Diebold Nixdorf DN Series™ BEETLE A1150](#)
- [DN AllConnectSM Data Engine for Data-Driven Intelligence Powering Actionable Insights](#)
- [Digifort IP Security System Digifort Cloud](#)
- [Digital Barriers Heat Detection Camera](#)
- [Digital China – Warehousing Business Automation and Visualization of Management Process Solution](#)
- [Digital China iSESOL Intelligent Manufacturing Solution](#)
- [Disrupt-X Cognitive Neurons](#)
- [Disrupt-X Ignite Shield](#)
- [DOTS Smart Energy Services](#)
- [Dot Zero Connect ZPS](#)

## E

- [Ectron Corporation SmartEYE™ Intelligent Edge Node](#)
- [Eigen Machine Vision](#)
- [Elenium HealthGate Touchless Control and Vital Sign Detection](#)
- [Exosite ExoSense Condition Monitoring Solution](#)
- [Expertos En Sistemas Braingine Machine Vision](#)
- [Exterity Digital Signage and IP Video Solution](#)
- [Extra Computer GmbH Calmo IOT Terminal for Manufacturing and POS](#)

## F

- [faytech AG EASY Shopper](#)
- [Flooid Solutions](#)
- [Fortinet Secure Branch](#)
- [ForwardX Robotics Visual Autonomous Mobile Robots](#)

## G

- [GDDi Algorithms Defined Edge AIBox Based on Intel® Series Chips](#)
- [Geek+ AI AMR Edge Cloud Smart Logistics Solution](#)
- [GE Healthcare Edison](#)
- [GeoVision Smart End-to-End Video](#)
- [Getac Video Solutions](#)
- [Giada Digital Signage Management](#)
- [Graymatics AI Driven Advanced Video Analytics](#)
- [Grupo MSA – Electronic Ballot System \(EBS\) by vot.ar](#)





# Solutions from H-L

Click the solutions to learn more about them

## H

- [Hangzhou Century Co. Fashion Industry IoT Solution](#)
- [Hikrobot: iWarehouse Intelligent Management Warehouse](#)
- [HiteVision Interactive Classroom Broadcasting Solution](#)
- [Honeywell Airport Solutions](#)
- [Honeywell City Suite Safe Cities](#)
- [HuaDian Intelligent Energy Management](#)
- [Hubz Smart Stores](#)
- [HY Medical AI-Assisted Diagnosis of Medical Imaging on IA Solution](#)
- [The Hark Platform](#)
- [HOOBOX Robotics Neonpass](#)

## I

- [i3-Technologies Hybrid Teaching](#)
- [Imedtac iVMS Intelligent Vital Signs Station](#)

- [IDIS Solution Suite and IDIS Center](#)
- [inefi Spotlight](#)
- [Indra Sistemas Onesait Sustainability Waste Citizen](#)
- [Industrial Network Security with Monitor for secunet edge](#)
- [IntraEdge and Pyramid Janus](#)
- [IntraEdge Truyo](#)
- [Innodep VURIX](#)
- [Invenda Interactive Vending and Advertising Platform for Retail and Hospitality](#)
- [iOmniscient Pty Ltd IQ Roads](#)
- [iProd MOP Manufacturing Optimisation Platform](#)
- [Intelligent Security Systems – SecurOS FACEx](#)
- [InSynerger Power Efficiency & Electrical Safety Management Solution](#)
- [ISSD Electronics SPECTO™ Incident Detection System](#)

## J

- [JelloX Biotech Inc. MetaLite® Digital Pathology Edge Solution](#)
- [Jian24 Smart Retail Solution](#)
- [Jovision Technology Smart Community Solution](#)
- [JWIPC iLearn Remote Class Interactive](#)

## L

- [LACHESIS Mhealth 5G Smart Ward Solution](#)
- [LG-MRI BoldVu® Kiosks](#)



# Solutions from M-O

Click the solutions to learn more about them

## M

- [M3T Retail Kiosk](#)
- [Mashgin Touchless Checkout System](#)
- [Matrox Imaging Manufacturing Machine Vision Solution](#)
- [Medigate Device Security Platform Powered by Dell and VMWare](#)
- [MegAAOI Spring Probe AOI Machine](#)
- [Megh Computing, Inc. VAS for Smart Buildings](#)
- [MIC's Sickbay™ Platform](#)
- [Microvision Machine Vision Kit for Smart Manufacturing](#)
- [Mirasys Women Safety Solution](#)
- [MiTAC Machine Vision in Factory Automation](#)
- [MITIS Health Lossless Remote Radiology & Pathology Home Reporting](#)
- [Mingtech Intelligent Medical Payment Platform](#)
- [MVISIA Desenvolvidores Inovadores S.A MVISIA WEG CVU](#)

## N

- [Nanjing Mythware Information Technology Mythware Smart Classroom](#)
- [NCR Emerald Retail Point of Sale Platform](#)
- [NCR FastLane SelfServ Checkout](#)
- [NEC SDM Integrated ECO-System](#)
- [Novarad Imaging Suite: Enterprise Imaging Management System, AR Surgical Guidance, and Image Sharing](#)
- [NTT System System Blue Bolt](#)

## O

- [Ocuvera Fall Prediction & Monitoring](#)
- [Olea Kiosks Inc. Ticketing and Booking Kiosks](#)
- [Olea Kiosks Inc. Healthcare Check-in Kiosk](#)
- [Ombori Apps AB Grid Compute Device](#)
- [Omnivex Moxie Digital Signage](#)
- [Onesait Active Grid Management Suite](#)
- [OnLogic – Ignition SCADA Solution](#)
- [OnLogic Singlewire InformaCast Fusion Server](#)
- [OnLogic ThingLogix Workwatch](#)
- [Onyx Intelligent Healthcare Interoperability Platform \(iHIP\)](#)
- [ORISOL Production Data Collection System \(PDCS\)](#)



# Solutions from P-S

Click the solutions to learn more about them

## P

- [Panasonic ArgosView](#)
- [Pathr.ai Spatial Intelligence](#)
- [Partner Tech Smart Hotel Self-Service KIOSK](#)
- [Passengera Fleet Connectivity and Infotainment Solution](#)
- [Perch Retail Displays](#)
- [PerfecTron Level 4 Autonomous Shuttle](#)
- [Petrosoft Cloud CStoreOffice®](#)
- [Phonexia Speech Platform](#)
- [PMY Group Venues Facility and Transportation Optimization](#)
- [Ponfac Count](#)
- [PreciTaste Prep Assistant](#)
- [Prescriptive Data NANTUM](#)
- [Pegatron 5G Private Network Solution: Digital Resilience](#)
- [Prowise Full Solution for Education](#)
- [PROTO Hologram Powered by Wachter](#)
- [Prox Systems Co., Ltd. Restaurant Smart Service Solution](#)
- [PT. Murni Solusindo Nusantara AI Powered Digital Public Information Display](#)

- [Pyramid Computer Essentry Visitor Verification](#)
- [Pyramid Computer GmbH Self Checkout Kiosk](#)
- [Pyramid Computer Magic Mirror](#)
- [Pyramid Computer Restaurant Ordering Kiosk](#)

## Q

- [Qisda ER Dashboard AIoT Information Platform](#)
- [Q-Net Security – Cybersecurity Hardware Solutions](#)
- [Qualitas Technologies EagleEye Platform](#)
- [Quanergy Flow Management](#)

## R

- [Relimetrics AI-Based QA Automation System for Electronics Assembly](#)
- [RF Controls Overhead CS Smart Antennas for Battery-Free RFID Based Real-Time Location](#)
- [RonPos - OnPrem Manageability System for Fuel Convenience Stores](#)
- [Runkong Smart Hospital Kiosk](#)

## S

- [Schoolnet India Limited K-Class Powered by K-Yan](#)
- [ScreenVend Digital Retailing Solution](#)
- [Seavo Kiosk Peripheral Management and USB Auto-Recovery](#)
- [Seavo Real-Time Face Recognition Gate](#)
- [Sertek All-in-One AI NVR](#)
- [Sertek EZcon Smart Building System](#)
- [Sewio Real-Time Location System](#)
- [Shandong Extreme Vision Open Kitchen Solution](#)
- [Shandong Extreme Vision Co., Ltd. Smart Community AI Solution](#)
- [Shandong Extreme Vision Co., Ltd. Smart Factory AI Solution](#)
- [Shandong Extreme Vision Co., Ltd. Smart Retail AI Solution](#)
- [Shandong Extreme Vision Smart Traffic Violation Review Solution](#)
- [ShareTech Information OT Security Solution](#)
- [Shenzhen Extreme Vision Intelligent Security Check](#)
- [Shenzhen Genew Intelligent Technology Multifunctional Smart LightPoles](#)
- [Shenzhen SED Initta Intelligent POS Solution](#)
- [Shenzhen JHCTECH Road Pricing Inspection System](#)



# Solutions from S-U

Click the solutions to learn more about them

## S

- [Shinsegae I&C Spharos Cloud POS](#)
- [7 StarLake 5G C-V2X Smart Traffic](#)
- [Stagu Technologies JARVIS For Manufacturing](#)
- [ST Engineering AGIL Smart Car Park Suite](#)
- [Super Micro Computer Inc. Retail Edge Evolution](#)
- [Sindrax Intelligent Gamified Kids \(Pre-school\) Education System](#)
- [Sindrax Technology Interactive Multimedia Sports Game](#)
- [Skratch & ANQ Phygital Video Wall](#)
- [Smart Board Interactive Display with Smart Ops PC](#)
- [SMRTI POD](#)
- [SNS Network SDN BHD JOI Smart Classroom](#)
- [Supermicro Industry 4.0 Evolving](#)
- [Supermicro Intelligent Secure Edge](#)
- [Supermicro Smart Digitalized Production Process Enhances Quality Control](#)
- [Systems with Intelligence Visual/Thermal Asset Monitoring System](#)

- [Sophic Automation Sdn Bhd Manufacturing Lights Off](#)
- [SSE Mayflower Insite Sentinel](#)
- [Synnex Technology International - Smart MES for Factory](#)

## T

- [Tata Consultancy Services TCS Equiptix](#)
- [Tata Consultancy Services Ltd. Self-Checkout Loss Prevention Solution](#)
- [TD Synnex Mobile Connected First Responder](#)
- [Teladoc Health TV Pro](#)
- [TELELOGOS Media4Display](#)
- [Telesoft TDAC](#)
- [Theatro Intelligent Voice Assistant for the Frontline Workforce](#)
- [TITANUSEYEoT DSS](#)
- [Toshiba Self Service Retail Total Solutions](#)
- [Toshiba TCxTM800 All-In-One POS and Remote Monitoring In-Store Experience](#)
- [Touch Cloud AI@Sense LPRS](#)

- [TouchSource Digital Directory Experience](#)
- [Touch Cloud/WPI TC Telescope](#)
- [Touch Cloud Abaci – The Realtime Flow and Crowd Counting Solution](#)
- [Touch Cloud Inc. Portable Smart Construction Site Surveillance and Event Detection System](#)
- [Trison signage.ninja](#)
- [Trueform Indoor and Outdoor Digital Advertising Displays](#)
- [TTTech Industrial Nerve Blue](#)
- [Tvarit Industrial AI Solution](#)

## U

- [UdyogYantra Technologies Food Quality and Quantity Authentication](#)
- [Uncanny Vision Uncanny Gate ANPR](#)
- [UST Global: Retail Analytics for Covid-19 and Beyond](#)
- [UST ColdTruth](#)
- [UST Vision Checkout Kiosk](#)
- [UST Vision Intelligence Box](#)



# Solutions from V-Z

Click the solutions to learn more about them

## V

- [Vaelsys V4](#)
- [Vecow VHub AI Fever Scan Solution](#)  
[Vecow Co., Ltd. Machine to Machine Solution](#)
- [Vecow Surface Defect Inspection Solution](#)
- [Vecow Sterilization AMR](#)
- [VeeMed TeleHealth Care Delivery](#)
- [Vehant Technologies TrafScan® Vehicle Detection System](#)
- [V-Series Drive-Thru Analytics Solution for Quick Service Restaurants \(QSR\)](#)
- [V-Sync SmartVendor](#)
- [Vesystem Cloud Terminal Healthcare Solution](#)
- [Videonetics Intelligent Video Management Software](#)
- [ViewSonic ViewBoard](#)
- [ViewSonic Wireless Collaboration Display](#)
- [VisionLabs LUNA PLATFORM](#)

## W

- [Wachter Healthcare NOVA](#)
- [WiCis Health 3.0](#)
- [Widya Robotics Intelligent Gate](#)
- [Wincomm Corporation Smart EMR Solution for e-Healthcare](#)
- [Wincomm Corporation Smart Hygiene Control Solutions](#)
- [Winmore Digit-China Barcodeless Goods Identification Kit](#)
- [Wintec QINGDAO Self-Checkout Solution Enabled with Loss Prevention](#)
- [Wipro Limited Digital Twin for Smart Buildings](#)
- [Wipro Limited Edge Device Management for OT and IoT](#)
- [Wipro Limited Smart i-Building](#)
- [Wobot Hygiene and Safety Module](#)
- [WolfVision Cynap Pure](#)
- [WPI Group SMT Intelligent Smart Storage Rack Solution](#)
- [Wuxi Xinje Vision Guided Intelligent Welding System](#)

## X

- [Xesol Drivox](#)
- [Xinje Electric X-SIGHT: Intelligent Industrial Controller](#)

## Y

- [Yanolja Y FLUX Kiosk Smart Hotel Lobby](#)
- [Yoi System Co., Ltd. i-X \(i-ECS: Intelligent-Edge Control System\)](#)

## Z

- [Zhejiang Jandar Technology Wise Medical Treatment](#)
- [ZRT Intelligent Medical Image Review and Consultation](#)

# 22Miles Visual Communications

## Solution Overview

22Miles Visual Communications provides corporate communications solutions that can be customized for any brand, aesthetic, or function. Integration agnostic, this solution meets the communications needs of a wide range of scenarios including operations, marketing, and security.

## Value Props



Optimize operations and ease of management by improving corporate communications, increased security, room booking and conferencing, hoteling, hot-desking, and guest management



Increase engagement by centralizing communications with dynamic custom content, supported by cloud computing and AI tools, that integrate past and live-time user data captured at the device's edge



Augment safety and security with Protection-as-a-Service™ by controlling authorized access and publishing real-time alerts to help mitigate public health and execute emergency protocols

## Intel Components

- Intel® Celeron® Processors
- Intel® Core™ i3, i5, i7, i9 Processors

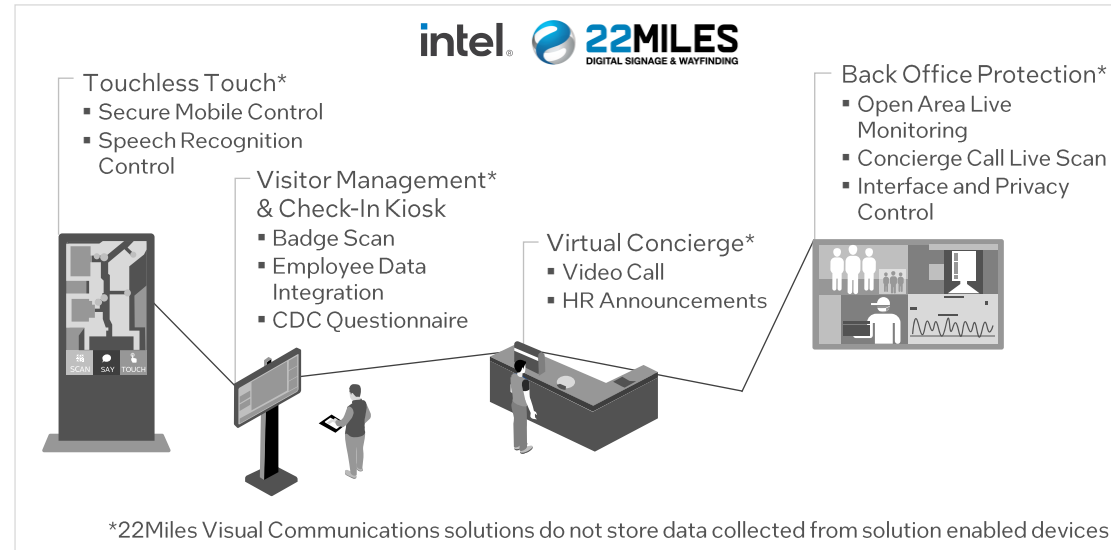

**Target Vertical:** Other  
**Secondary Verticals:** Government, Banking, Education, Health & Life Sciences, Hospitality, Transportation

**Target Use Case:** Interactive Media

**Geo Availability**  
 Asia/Pacific/ Japan, People's Republic of China, Europe/Middle East/Africa, United States, Latin America and Canada

## Learn More

- [22Miles Resources and Case Studies](#)
- [Digital Signage for Corporations](#)
- [Intel® & 22Miles - Solutions Video](#)
- [22Miles Supported Integrations](#)

# 22Miles Interactive Wayfinding Kiosk

[Back to Transportation Solutions](#)

[Back to Interactive Media Use Cases](#)



## Solution Overview

A powerful digital signage solution that improves the wayfinding experience by helping end-users navigate busy, complex transportation hubs and buildings using interactive, real-time navigation, mapping, and info, all easily managed from the 22Miles Publisher Pro CMS.

## Value Props



Inform and engage end-users with dynamic messaging, AR content, and 3D map views



Improve the wayfinding experience with smart pathway algorithms and destination routing



Simplify signage management through a centralized content management systems

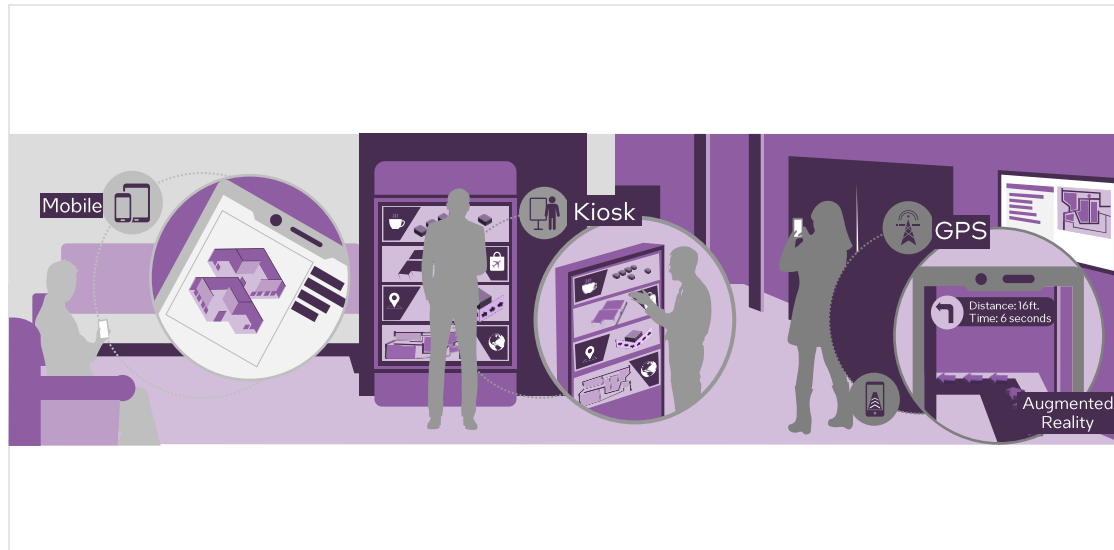

## Intel Components

- Intel® NUC featuring Intel® Core™ i5 and Intel® Core™ i7 processors
- Intel® Xeon® processors

**Target Vertical:**  
[Transportation](#)

**Secondary Verticals:**  
[Hospitality](#), [Education](#),  
[Health & Life Sciences](#),  
[Government](#), [Enterprise](#)

**Target Use Case:**  
[Interactive Media](#)

**Secondary Use Case:**  
[Situational Monitoring](#)

## Geo Availability

North America, South America (except for Argentina), EMEA, APAC (Japan, Korea, Hong Kong)

## Learn More

- [22Miles interactive wayfinding kiosk product webpage](#)
- [22Miles case studies](#)

# Interactive Video Walls

## Solution Overview

The 22Miles video wall solution is compatible with any Intel® Core™ i5, i7 to i9 based player. Once engaged with a customer, the first task is to define the technical requirements, such as the video wall size, the resolution, the desired design and application usage, and the different media file formats to use. The next step is to upload the content into the CMS and set up how the content will be shown where, when, and how. The CMS software works simply off the Width and Height canvas and some added calibrations with the Intel-based player to ensure that content is published and displayed in the area as defined. Interactivity data gathered at the edge is also sent to this platform for insights and analysis, allowing clients to build and manage video wall solutions with easily customizable content zones and other personalization.

## Value Props

- Engage with potential customers** by leveraging real-time data to deliver custom automated, high-resolution, engaging content
- Reduce operational complexity** and relieve team workloads by deploying an easy-to-use and to-learn CMS. This allows practically any staff to manage, schedule and publish interactive media quickly without involving IT.
- Deploy and scale with ease** by utilizing a platform designed to integrate as many 3<sup>rd</sup> party APIs as necessary to help clients successfully connect the 22Miles hardware and software with their existing systems. Admins can enjoy quick and easy control with drag-and-drop functionality when curating content.
- Optimize content distribution** through content management software that handles animations, high-definition videos, and live data feeds that can be deployed on any screen, at any size, and remotely managed from anywhere.

## Intel Components

- Intel® Xeon™ SP Gold
- Intel® NUC

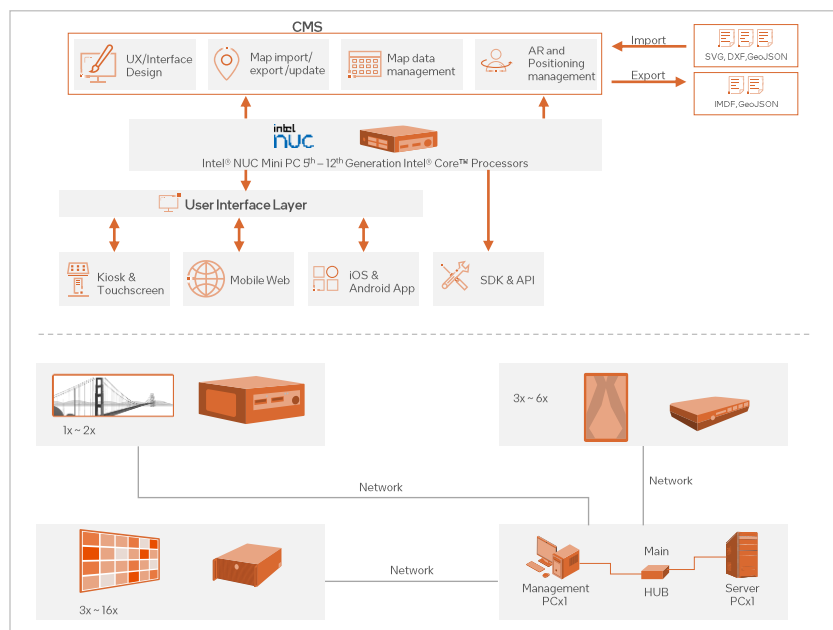

**Target Vertical:** Retail  
**Secondary Vertical:** Banking/Financial Services, Education, Government, Hospitality and Restaurants, Manufacturing, Transportation and Warehousing, Healthcare  
**Partner-Provided Vertical:** Large Venues and Convention Centers, Casinos and Resorts, Mixed-Use

**Target Use Case:** Interactive Media  
**Secondary Use Case:** Logistics & Tracking  
**Partner-Provided Use Case:** Visual Communications

**Geo Availability**  
 Global

**Sales Contact**  
[imari.adams@mail.22miles.com](mailto:imari.adams@mail.22miles.com)

- Learn More**
- Corporate Offices Video Wall - Nationwide
  - Video Walls | Digital Signage & Wayfinding Software
  - Contact Us | Digital Signage & Wayfinding Software





# Adapdix EdgeOps

## Solution Overview

Adapdix EdgeOps is an edge software platform that combines autonomous control with distributed DataMesh technology to enable autonomous manufacturing. EdgeOps' containerized architecture captures, stores, analyzes, and synchronizes data, delivering machine intelligence and autonomous control of advanced manufacturing processes. It reduces latency and improves security, privacy, and cost, by bringing applications to your data rather than moving your data to the application.

## Value Props



**Improved Operational Efficiency** including reductions in unplanned downtime and increased production yield across advanced manufacturing environments. EdgeOps is easy to use and quick to deploy solution, with proven ROI in weeks.



**Reduced Data Management Costs** the Adapdix DataMesh is the first product in the market which encapsulate contemporary enterprise data management theory. It helps remove obstacles such as latency, security, privacy, and cloud cost, by facilitating a domain-based architecture. Adapdix DataMesh empowers end-users to link events across multiple data sources, bridging data silos. This delivers higher application performance, better data quality, contextualization, and is a critical prerequisite for autonomous systems.



**Reduced TCO for complex machinery and systems** through initial capex avoidance because improved productivity of current assets means you avoid buying additional new equipment.

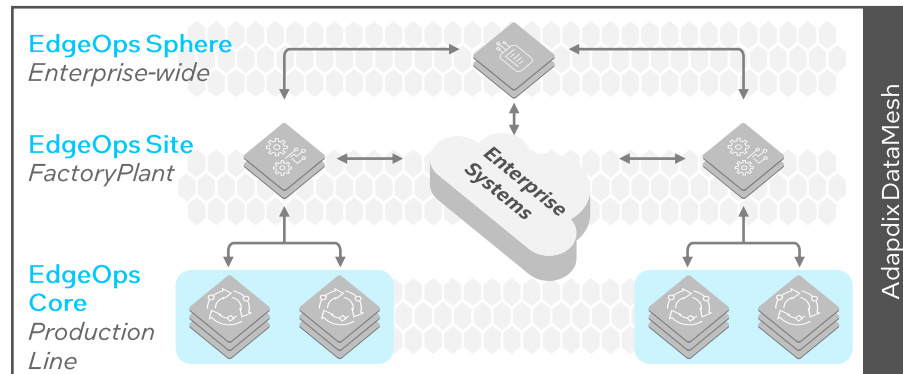

## Kit Components

- Intel® NUC
- Industrial PC

**Target Vertical:**  
Manufacturing

**Secondary Vertical:**  
Health & Life Sciences

**Target Use Case:**  
Control Optimization & Autonomy

**Secondary Use Cases:**  
Situational Monitoring, Machine Condition Monitoring, Product Inspection

**Geo Availability**  
Asia, Pacific, Japan, Americas, Europe, Middle East, Africa

## Learn More

- [Adapdix EdgeOps Webpage](#)
- [Adapdix EdgeOps Solution Overview](#)



### Solution Overview

Advantech's energy sustainability management suite – the WISE Factory EHS platform – defines the correct data acquisition methods for baseline management, KPI settings, and energy saving objectives while offering effective monitoring solutions for companies. The WISE Factory EHS platform provides clear data on overall energy usage with an all-in-one system that is easily implemented. With this platform, companies can meet new standards for energy performance more easily and improve their carbon/greenhouse gas emissions, moving towards a "net zero" goal.

### Value Props



**Centralize Data Management:** Systems Managers can easily review real-time and historical data with ongoing insights into energy consumption and energy saving activities all from one central display, saving time and reducing labor costs



**Reduce Energy Consumption:** Businesses can deploy a single platform that collects data regarding all energy consumption, allowing them to make business decisions that reduce their overall energy usage



**Deploy Efficiently:** The Advantech WISE Factory platform is optimized for quick implementation with existing technology and facilities and quickly draws data from multiple sources for analysis

### System Architecture

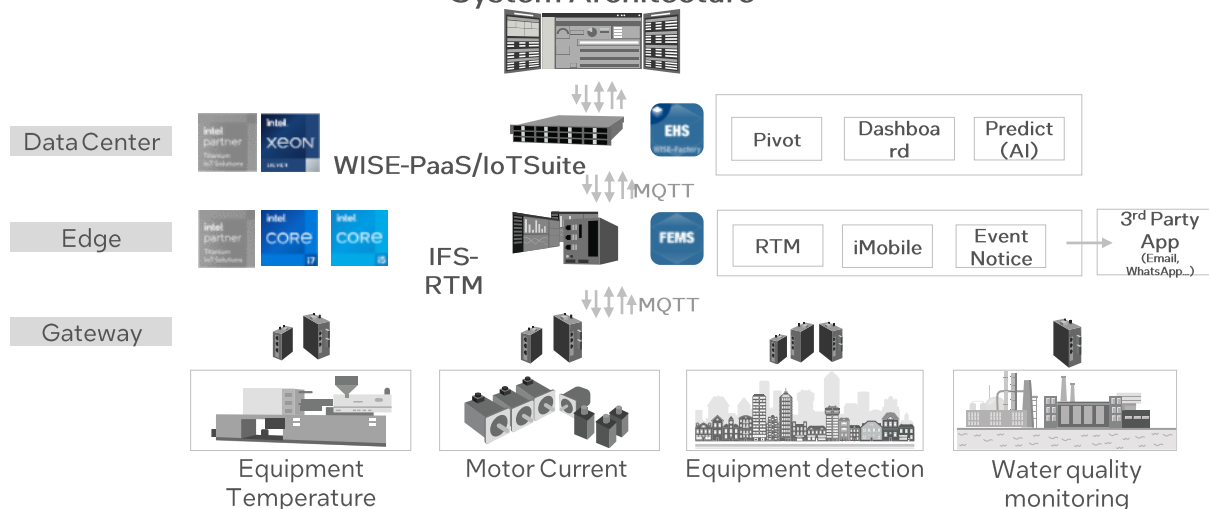

### Intel Components

- Intel® Core™ i3, i5, i7 Processors
- Intel® Celeron® Processors
- Intel® Xeon® Processors

Target Vertical:  
Manufacturing

Secondary Vertical:  
Energy

Target Use Case:  
Energy Monitoring and Management

Geo Availability  
Asia, Pacific, and Japan, Americas, Europe, Middle East, and Africa, People's Republic of China

### Learn More

- WISE Factory landing page
- WISE-FactoryEHS Catalog
- FEMS I.App page



## Advantech Equipment Vibration Monitoring

### Solution Overview

Advantech's Equipment Vibration Monitoring Solution is an integrated solution-ready package that facilitates real-time vibration monitoring, time-frequency vibration data analysis, and alarm management. Users can realize vibration data visualization and status monitoring to enhance maintenance efficiency.

### Value Props



Increase system uptime with predictive maintenance and real-time vibration monitoring at the edge



Integrate with ease using a sensor-to-cloud solution that connects edge sensors with vibration monitoring software



Streamline deployment with a pre-loaded equipment status management dashboard and remote monitoring

### Intel Components

- Intel® Core™ i5 Processors
- Intel® Core™ i5 6300U

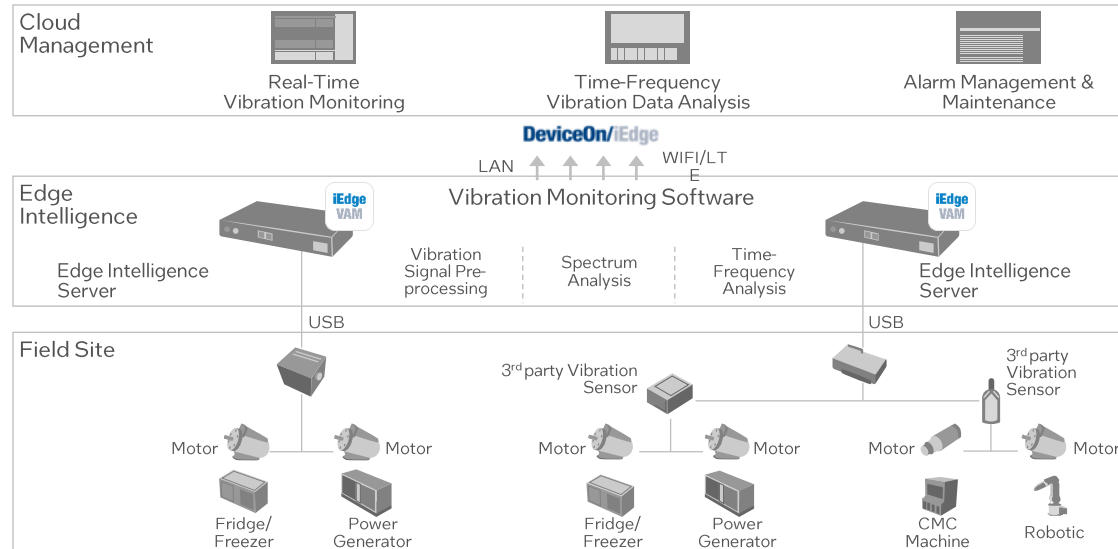

Target Vertical:  
Manufacturing

Target Use Case:  
Product Inspection

Geo Availability  
Available in Taiwan, China, Singapore, Japan and USA

Learn More  
Advantech website



# AI-Powered Logistic Solution – Alfabet

## Solution Overview

A solution that provides real-time information of all activities and movements, allowing end-to-end management of flow of goods, and data-driven analytics for decision making. This effectively addresses the need for more efficient logistics costs to gain competitive advantages.

## Value Props



Increase efficiency and shorten cycle time



Generate effective control, transparent procedures, and real-time monitoring



Improve sales and business profitability by enhancing existing systems and processes

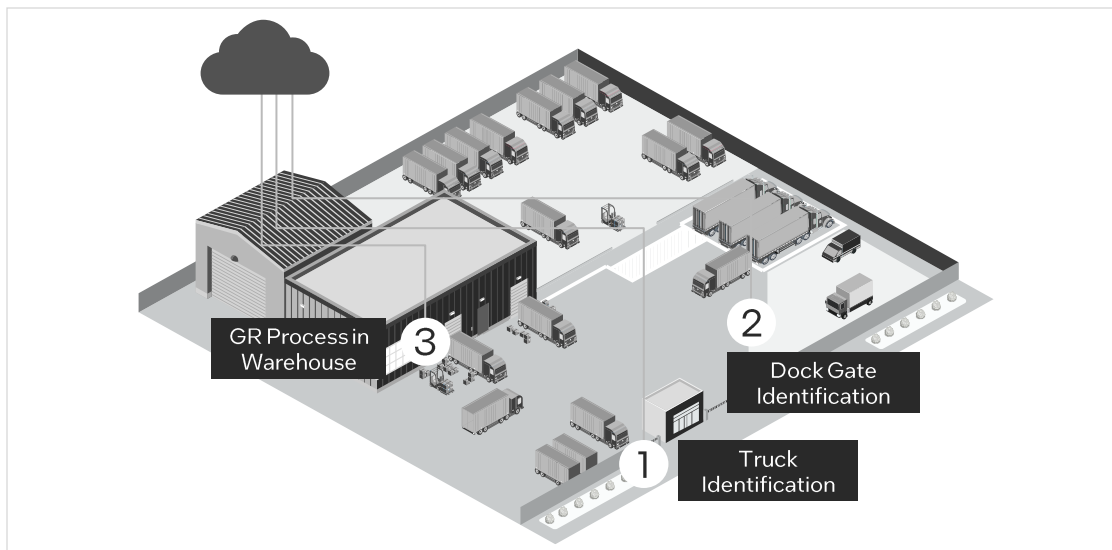

## Intel Components

- Intel® Xeon® Processors
- Intel® Core™ i5
- Intel® NUC
- Intel® OpenVINO™ toolkit
- Intel® Media SDK
- Intelligent Video Analytics
- Optical Character Recognition
- Heatmap Generation
- Facial Recognition Technology

**Target Vertical:**  
[Manufacturing](#)

**Target Use Case:** [Logistics & Tracking](#)

**Secondary Use Case:**  
[Situational Monitoring](#)

**Geo Availability**  
Available in APJ

### Learn More

- [Proof of Concept Report](#)
- [Alfabet Technology Solutions](#)
- [Alfabet Partnership with Intel](#)



Back to Manufacturing Solutions

Back to Situational Monitoring Use Cases



# AIRA Corporation airaTrack

## Solution Overview

airaTrack is an intelligent monitoring solution that captures, matches, and tracks faces without violating individual privacy by using automatically-generated face indexes. Faces can be captured in real time or pulled from an existing video archive. By reviewing and making a selection from an index of faces, authorized personnel leverage AI to review all video streams across the venue that contain the selected face, while other individuals are blurred. This solution can be used in most environments and with an organization's existing camera equipment. Video data from cameras is distributed by VMS software to airaTrack where it's processed at the edge.

## Value Props



Help improve security for customers and employees by leveraging an intuitive, AI-enabled smart monitoring solution



Maximize ROI by leveraging existing camera infrastructure and scaling easily through adding or subtracting camera feeds



Improve security team efficiency with AI-enabled, automatic face search and matching functions that save hours of manual search time

## Intel Components

- Intel® Distribution of OpenVINO™ toolkit
- Intel® Xeon® processors
- Intel® Core™ processors
- Intel® NUC

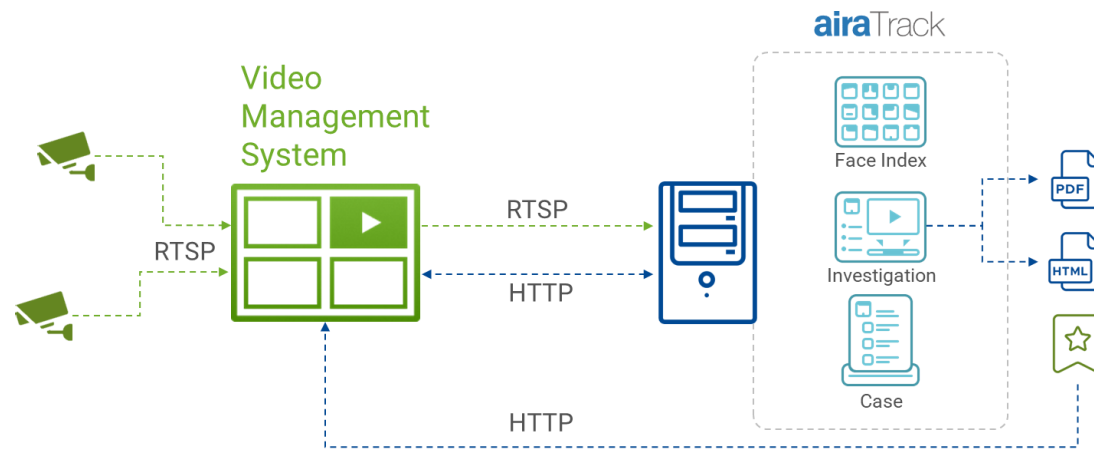

Target Vertical: Manufacturing

Secondary Vertical: Retail, Transportation and Warehousing, Government

Target Use Case: Situational Monitoring

Geo Availability: APJ, Americas, EMEA

## Learn More

- [airaTrack Product Page](#)
- [aira Corporation Website](#)



# AllGoVision – AI Powered Video Analytics

## Solution Overview

A reliable and accurate surveillance AI solution capable of analyzing a wide set of 50 edge events in smart cities, buildings, and smart businesses by tracking up to 200 cameras per server

## Value Props



Monitor cities and traffic with alarm cases from speed alerts, to license plate recognition



Secure smart buildings by monitoring boundary crossings, and smoke and object detection



Gain business insights by tracking crowd movement and facial recognition

## Intel Components

- Intel® Core™ i7
- Intel® Xeon®
- Intel® Vision Accelerator Design Products with Intel® Myriad™ Movidius™ X VPU

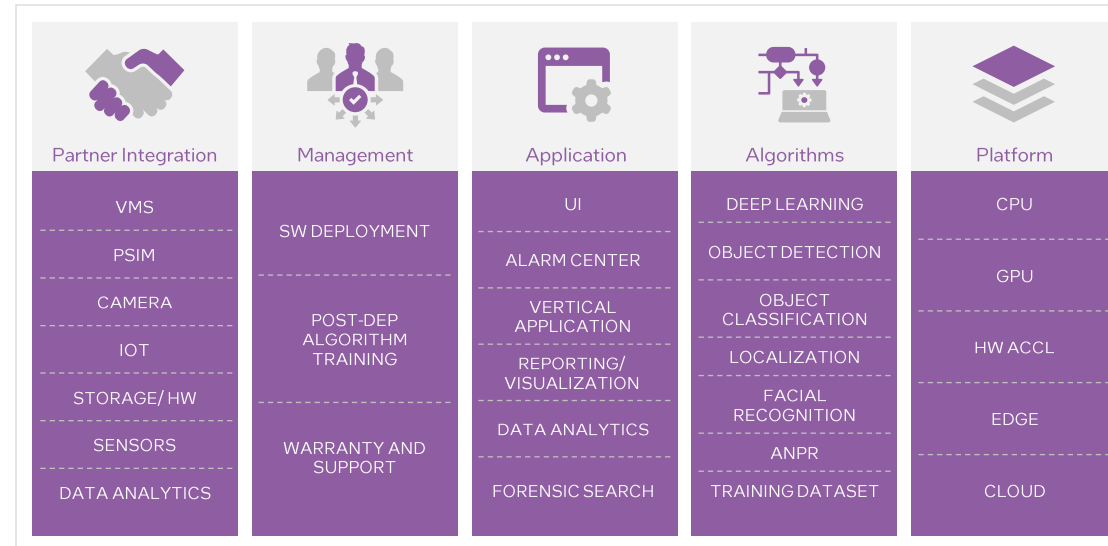

**Target Vertical:** Government  
**Secondary Verticals:** Retail, Banking/Financial Services, Hospitality, Education, Manufacturing, Transportation, Agriculture

**Target Use Case:** Situational Monitoring  
**Secondary Use Cases:** Environment Monitoring, Product Inspection, Human Wellness Monitoring

**Geo Availability:** Globally

### Learn More

- Reach out to the deployment contact at [contact@allgovision.com](mailto:contact@allgovision.com)
- Visit the AllGoVision website at <https://www.allgovision.com>
- Order by reaching out to the deployment contact at [contact@allgovision.com](mailto:contact@allgovision.com) or by visiting the AllGoVision website at: <https://www.allgovision.com/>



# Ambient Clinical Analytics Aware Family



## Solution Overview

AWARE is a digital health clinical decision support system that provides a clinical “smart view” of Electronic Health Record data to reduce the risk of medical error and improve patient outcomes. We provide point of care and clinical command center solutions to improve care for conditions like sepsis. It works with your EMR system and bedside monitors to present only relevant information configurable for your care practice on a single screen dashboard.

## Value Props



**Reduce clinical errors** – employs EHR system and bedside device data to present pertinent information at the point of care with intuitive visualization



**Drive medical best practices** – Enhances clinical protocol compliance by ensuring bundle therapies and timelines are met



**Reduce costs for patients & providers** Increases quality, decreases length of stay, eliminates unnecessary costs, and streamlines clinical workflows

## Intel Components

- Intel® Xeon™ Processors
- Intel® Core™ i5 Processors

Visualization

Integrated Data Knowledge



Rule based system – Alerts (Data Sniffers)

Target Vertical:  
Health & Life Sciences

Target Use Case:  
Human Wellness Monitoring

Secondary Use Case:  
Interactive Media

Geo Availability  
North America, (Europe, China, and India pending end of Q1 2019)

Learn More  
Ambient Clinical Analytics Aware Family website



# Analysis Decision Platform

## Solution Overview

The AIBDT Analysis Decision Platform helps semiconductor manufacturers achieve their Industry 4.0 goals by collecting data from all aspects of the factory and using AI to analyze the collected information, identify production abnormalities, and generate multiple report types so users can harness insights to increase fabrication efficiency, decrease losses, and improve product quality. AIBDT's modular structure provides a flexible combination of scalable hardware, software, development tools, and consultancy services that ensures users are optimizing their IoT investments and implementing continuous improvements.

## Value Props



**Reduce labor costs:** by decreasing the number of staff and time required to record, analyze, and convert complex data sets into valuable reports



**Optimize for efficiency:** by leveraging comprehensive data, analytics, and consultancy services to make informed adjustments to production processes, workforce utilization, equipment usage, and factory layouts to streamline factory workflows, improve product quality, and increase delivery rate



**Reduce downtime:** by providing maintenance staff with abnormal data trends in real-time so they can quickly and accurately identify, assess, and correct the root causes of abnormalities anywhere in the plant

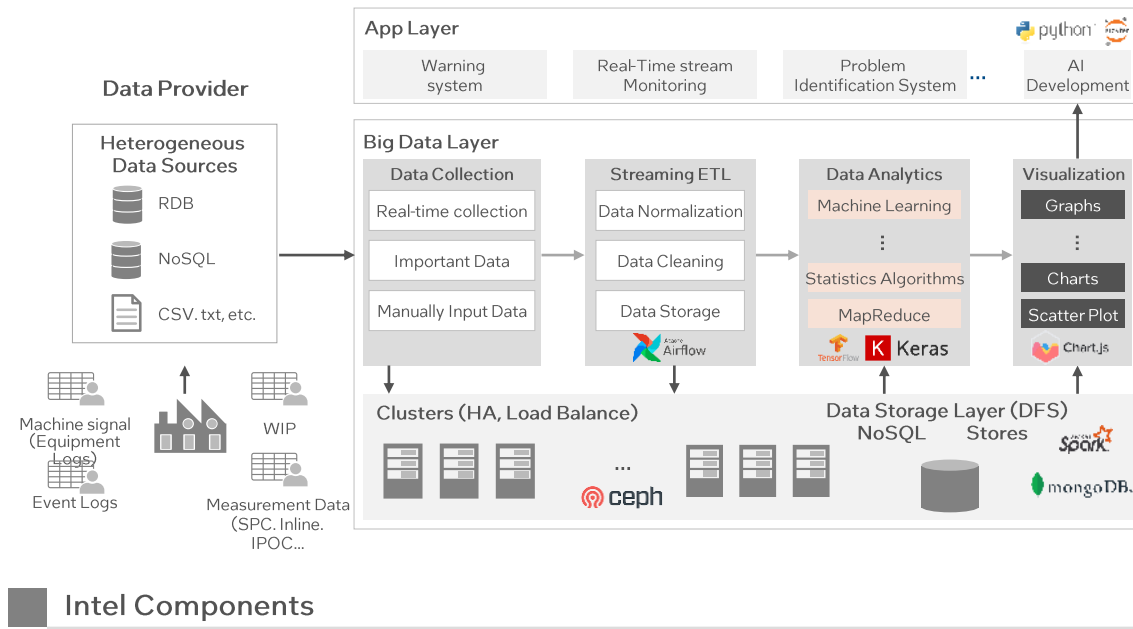

## Intel Components

- Intel® Core™ i5 Processors

**Target Vertical:**  
Manufacturing

**Target Use Case:**  
Situational Monitoring

**Secondary Use Case:**  
Energy Monitoring & Management, Environmental Monitoring, Logistics & Tracking, Machine Condition Monitoring, Product Inspection

**Geo Availability**  
Brazil, Canada, Mexico, United States, Other Americas, Australia/New Zealand, India, Japan, South Korea, PRC, Taiwan, Germany, Israel, Middle East, Russia, North Africa, Turkey, Russia, Sub Saharan Africa, UK

**Learn More**  
AIBDT Solution Website





Back to Hospitality Solutions

Back to Control Optimization & Autonomy Use Cases



# AiMall Virtual Store Supervisor

## Solution Overview

The Virtual Store Supervisor (VSS) functions as a digital version of a human supervisor. The VSS leverages digital sensors such as cameras, temperature and humidity readers and microphones to read the flow of customers and their level of engagement within the store/restaurant. Sensors also gather inanimate data, including the availability and usage of tables, supplies, and inventory, and how products and visuals are displayed. Additionally, data regarding staff allocation and performance is gathered to enhance service. All data and insights collected can be communicated to store managers remotely so that they can take quick action.

## Value Props

- Reduce operational costs by monitoring inventory in real-time and reducing the need for labor for in-person monitoring.
- Enhance customer experience by reading level of engagement, service standards, and employee performance for quick responses to any issues.
- Scale business quickly by removing the need for in-person management in stores; easily create new locations that can be monitored in real-time remotely.

## Intel Components

- Intel® Distribution of OpenVINO™ Toolkit
- Intel Atom® Processors
- Intel® Core™ Processors
- Intel® Xeon® Processors
- Intel® Iris® Xe graphics
- Intel® HD Graphics
- Intel® Movidius™ Vision Processing Units

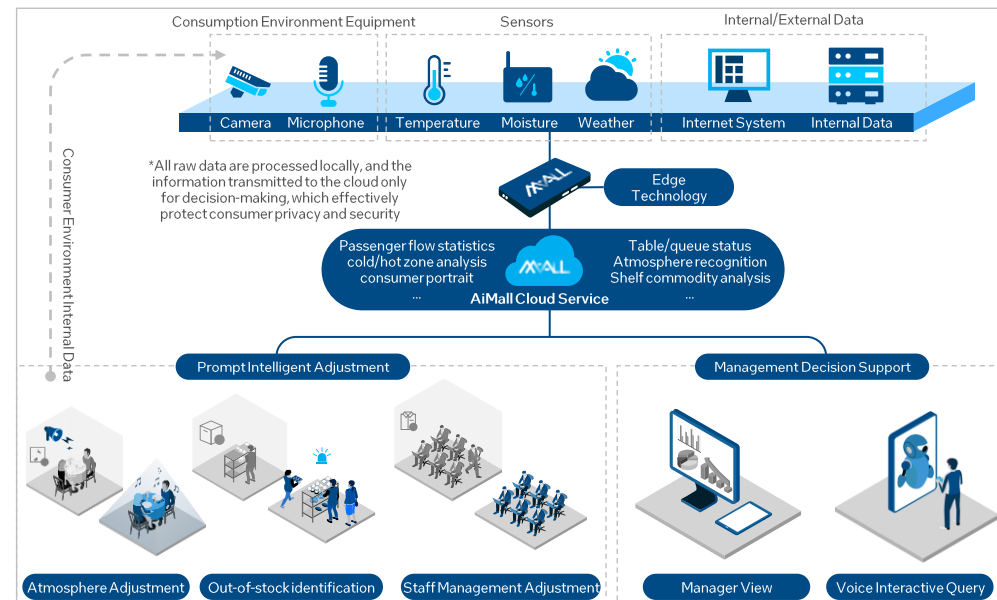

Target Vertical: Hospitality

Secondary Vertical: Retail

Target Use Case: Control Optimization & Autonomy

Secondary Use Cases: Environmental Monitoring, Interactive Media, Energy Monitoring & Management, Machine Condition Monitoring, Asset & Operations Optimization, Situational Monitoring, Human Wellness Monitoring, Product Inspection

Geo Availability: People's Republic of China



Learn More: AiMall website



### Solution Overview

The AIRA airaFace solution provides highly accurate facial recognition capabilities for customers. Implementing a proprietary facial recognition engine, faces from multiple inputs such as cameras, tablets, and NVRs are analyzed to perform access control management, attendance tracking, visitor self-check-in, watchlist and deny list, VIP detection, and more.

### Value Props

-  Simplify access points and clearances for employees and partners with a seamless welcome system, surveillance, and notification systems
-  Enhance security and safety with facial recognition capabilities and person/user management
-  Reduce labor costs with customizable, fully-automated identification and access systems

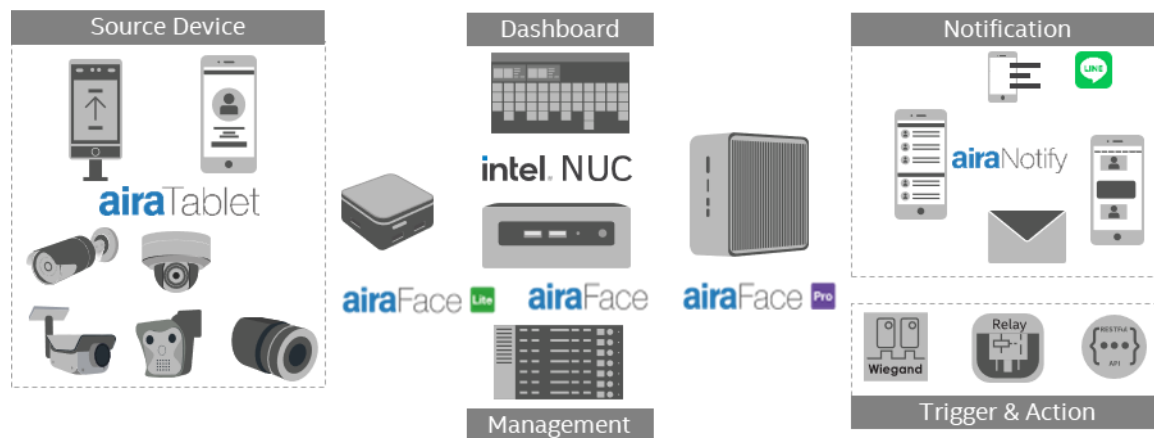

Target Vertical:  
Manufacturing

Secondary Vertical:  
Hospitality, Retail

Target Use Case:  
Human Wellness Monitoring

Geo Availability  
United States, United Kingdom, Japan, Taiwan, Southeast Asia

Learn More  
▪ [AIRA website](#)

### Intel Components

- Intel® NUC
- Intel® Xeon® Processors
- Intel® Distribution of OpenVINO™ Toolkit
- Intel® Core™ Processors



# AIRxTOUCH KIOSK Series 3

## Solution Overview

Powered by AIR TOUCH® technology, the AIRxTOUCH KIOSK Series 3 solution is an interactive, touchless display for use-cases such as retail directories, QSR self-ordering, museum exhibits and more. Using touchless display technology, businesses can enhance public safety by reducing physical contact for customers while also tracking user analytics that inform system maintenance and enhance marketing actions. The AIRxTOUCH Kiosk solution adapts to meet client needs in fields of collaboration, communication, entertainment, marketing, and education.

## Value Props



Gain actionable insights with touchless display technology powered by an Intel® NUC player that captures user interactions



Deploy with ease by installing a fully calibrated, all-in-one kiosk solution designed to plug and play in open public spaces



Improve user experiences with an interactive, touchless display that informs users while avoiding the need for physical contact

## Intel Components

- Intel® NUC
- Intel® Core™ i5 Processors

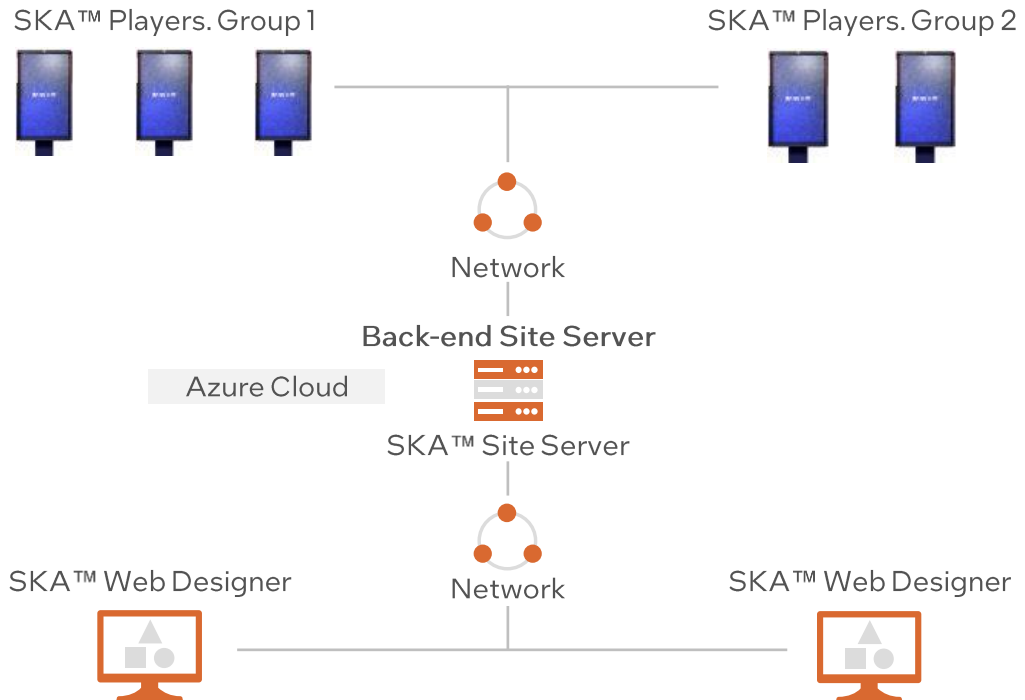

**Target Vertical:**  
Retail

**Secondary Vertical:**  
Hospitality and Restaurants,  
Transportation,  
Banking/Financial Services,  
Corporate, Tourism

**Target Use Case:**  
Interactive Media

**Geo Availability**  
Americas, Europe, Middle East, and Africa

**Learn More**  
[AIRxTOUCHWebsite](#)

## Autocanteen Self-Service



### Solution Overview

The Autocanteen Self-Service is an AI powered self-checkout solution using computer vision and machine learning to recognize items like food on plates or packaged drinks and snacks to help in-store customers carry out transactions more quickly and precisely. The solution starts by scanning food objects using a 3D Image scanner to capture high quality images of food products. Once the scanner captures the image, an intelligent computer vision algorithm breaks the image down by context to detect and classify objects by known classes using a deep neural network of AI. Analyzed data is then sent to the cloud for knowledge-sharing purposes and clients get access to all their data via a cloud-based dashboard where all menus, inventory, sales, etc. are combined and available 24/7. All communication occurs via wired interfaces with no sensitive customer information processed during the transaction.

### Value Props



**Empower your team** by requiring only one employee to oversee multiple self-checkout points. Delegate staff with non-checkout tasks to drive new business outcomes and improved customer service



**Reduce queues** by processing transactions within 10 seconds on average. Higher throughput during peak times will also mean increase in revenue



**Stay innovative and impress clients** by encouraging more customer engagement and revenue growth with Autocanteen's unique digital catering offerings

**1. Scan**  
Depth camera captures high quality 3D image.

**4. Learn and sync**  
Learnt data sent to the cloud building up the knowledge-sharing network.



**2. Detect objects**  
Intelligent computer vision algorithm breaks image down by context.

**3. Classify**  
Deep neural network AI segregates found objects by known classes.

### Intel Components

- Intel® Core™ i5 Processors
- Intel® Core™ i3 Processors
- Intel® Distribution of OpenVINO™ toolkit

Target Vertical:  
Hospitality

Secondary Vertical:  
Retail

Target Use Case:  
Asset & Operations Optimization

Geo Availability  
Americas, Europe, Middle East, and Africa

Learn More  
[Autocanteen Homepage](#)

# Avocor All-In-One Interactive Display with Intel® OPS

## Solution Overview

The Avocor All-in-One Interactive Display with Intel® Open Pluggable Specification (OPS) is a high-performance, maintenance free touchscreen that delivers conference-grade audio, video, and productivity tools within a mobile, interactive meeting display. Transform your meetings with an intuitive user experience, smart input switching, and precise, pen-on-paper inking and touch recognition with Avocor Intelligent Touch. Optimize infrastructure management with room environment data and control from a single, centralized dashboard. Avocor interactive displays and software provide a single, cable-free interface for creating immersive environments that enable optimal meeting productivity and collaboration.

## Value Props

**Increase meeting productivity and efficiency** with a personalized, plug and play display that's ready to create immersive meeting experiences right out of the box.

**Streamline infrastructure management** with centralized room health and settings controls. View and manage light levels, telemetry data, and more from a single dashboard.

**Transform decision making** by gaining valuable data and insights to enhance future meetings, inform room planning and utilization, track meeting agenda status, and more.

## Kit Components

- Intel® Core™ i7 processors
- Intel® Core™ i5 processors

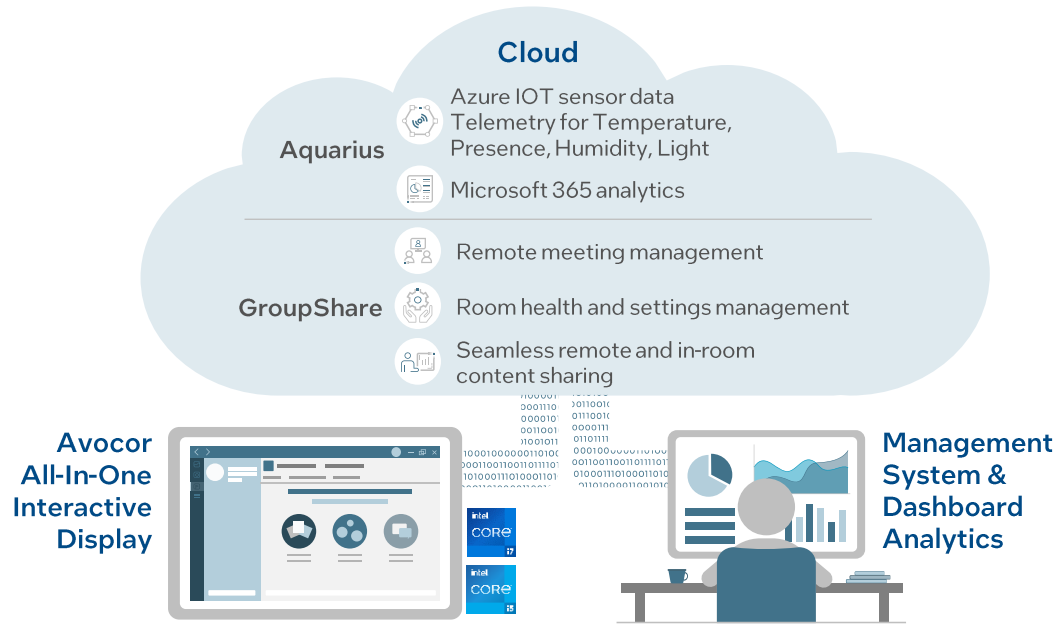

**Target Vertical:**  
Banking/Financial

**Secondary Vertical:**  
Government, Health & Life Sciences, Manufacturing

**Target Use Case:**  
Interactive Media

**Geo Availability**  
APJ, EMEA, Americas

### Learn More

- Jumpstart your meetings with Avocor
- Learn more about Avocor AVW-5555



# Awiros Video Intelligence Platform

[Back to Retail Solutions](#)

[Back to Situational Monitoring Use Cases](#)



## Solution Overview

The Awiros Video Intelligence Platform is a complete, dynamic platform for video intelligence that can be deployed on any camera in a customer's network to address a range of video analytics scenarios. Awiros offers a cloud dashboard, real-time alerts, and AI-enabled insights that help transform video footage into actionable information.

## Value Props



Develop AI apps with ease and deploy them at the edge or in the cloud to analyze any video stream



Scale with the click of a button across hardware, video sources, and apps to respond quickly to changing needs



Manage video streams and apps conveniently by dynamically allocating resources across locations, apps, and video sources



## Intel Components

- Intel® Core™ i5 processors
- Intel® Xeon® processors
- Intel® Movidius™ Myriad™ X VPUs
- Intel® Ethernet Network Adapter (10GbE)
- Intel® Distribution of OpenVino™ Toolkit

**Target Vertical:** Retail

**Secondary Verticals:** Manufacturing, Public Safety, Transportation, Traffic Management, Logistics, and Warehousing

**Target Use Case:** Situational Monitoring

**Secondary Use Case:** Asset & Operations Optimization

**Geo Availability**  
Asia/ Pacific/Japan

## Learn More

- [Awiros Website](#)
- [T-Hub Article on Awiros](#)
- [Awiros Introduction Video](#)

# Axians IoT Operations Green Edge

## Solution Overview

Green Edge is a real-time environmental footprint reporting system that aims to support companies in their journey toward carbon neutrality. The solution collects real-time data from buildings, such as cold or hot water, electricity consumption, ventilation, heating, cooling, etc. Once the data is collected, the solution aggregates and analyses the data to provide visualizations and actionable insights.

## Value Props

- Reduce environmental impact** and meet carbon neutrality goals by utilizing automated reporting of BU per BU data insights to help promote actions for where less energy consumption is needed
- Adapt to monetary constraints** by establishing environmental budgets, and tracking action plans to help aid expenditure decisions throughout the year
- Optimize operations and management** using a digitally consolidated dashboard for managing a plethora of data from sensor edge devices and API integrations collected daily

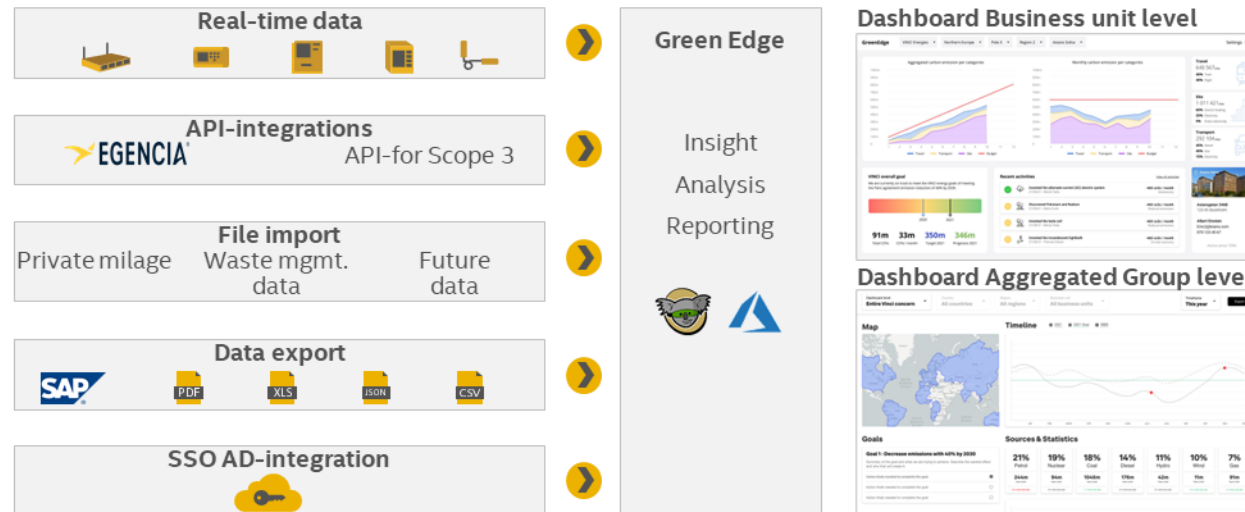

## Intel Components

- Intel® Distribution of OpenVINO™ toolkit
- Intel® NUC

**Target Vertical:**  
Energy

**Secondary Vertical:**  
Manufacturing

**Target Use Case:**  
Environmental Monitoring

**Geo Availability**  
APJ, Americas, Europe, Middle East, and Africa, People's Republic of China

## Learn More



- [Axians IoT Website](#)
- [Axians – Homepage](#)

# Axis Camera Station S-Series Network Video Recorders

## Solution Overview

At the core of every video surveillance system is the Video Management Software (VMS) and the Storage Server – also known as a Network Video Recorder (NVR) – where video is stored. This Axis solution provides users with full situational awareness and proactive security.

## Value Props

-  **Protect what matters** – Axis has a surveillance solution for almost every scenario
-  **Go beyond security** – Easily enhance your solution with analytics, network audio and more
-  **Expand easily** – Quickly add new devices or other locations

## Intel Components

- Intel® Core i5 Processors
- Intel® Xeon® Processors
- Intel® Xeon® Processors
- Intel® HD Graphics



**Target Vertical:**  
Other

**Secondary Vertical:**  
Banking/Financial Services;  
Education; Energy; Health &  
Life Sciences; Hospitality;  
Manufacturing; Government;  
Retail; Transportation

**Target Use Case:**  
Situational Monitoring

**Geo Availability**  
More than 50 countries

### Learn More

- [Axis Intel marketplace page](#)
- [Axis Camera Station webpage](#)
- [Axis communications homepage](#)
- [Axis end-to-end solutions for surveillance page](#)





# beamLive, Inc. – Unified Mobile IoT Communication

## Solution Overview

The Beam/Intel partnership has created market-ready **Unified Mobile IoT Communications** built on integrated edge and cloud computing technologies. It combines AI-processed IoT Messaging, Geo-tagged Content Sharing and Mobile Collaboration features to Mission-Critical and Time-Sensitive operations. It serves high growth markets ready to migrate from legacy voice/text communication to Broadband IoT including Public Safety, Telemedicine, Enterprise UCC, Mobile Workforce and Shared Resources/Assets Economy. Beam utilizes core Intel Edge, AI and networking technologies combined with Beam sub-second IoT connectivity across Wearables, iOS, Android, Linux and Wins Devices. It processes IoT data using AI and filters messages and notifications to a target audience with Analytics in-real-time. The Communication as a Service (CaaS) business model, available via the **beamStore™ Powered by Intel**, enables Mobile/Web Apps configured by 3<sup>rd</sup> party developers in just days.

## Value Props



**Migrate from legacy to broadband IoT communication** – take mission-critical communication beyond voice/text only to real-time IoT Messaging including GPS, Biometrics and Video combined with Analytics in-real-time.



**Save money replacing multiple apps with beam** – beamPlatform integrates multiple IoT services/apps with comprehensive text, voice and multimedia service and allows customization across all mobile platforms in days.



**Real-time Actionable Knowledge driven from IoT and Mobile Data** – protect and monitor mobile workforce and assets, deliver mission-critical and time-sensitive messages and content in real-time with sub-second latency M2M Connectivity.

## Intel Components

- Intel® Distribution of OpenVINO™ toolkit
- Intel® Core™ i5 Processors
- Intel® Xeon® Processors
- Intel® Optane™ Memory
- Intel® NUC
- Intel® Atom® Processors
- Intel® Core™ i7 Processors
- Intel® Iris® Graphics
- Intel® AI Edge Server
- Intel® Server GPU
- Intel® Core™ i9 Processors
- Intel® ARC™ Graphics

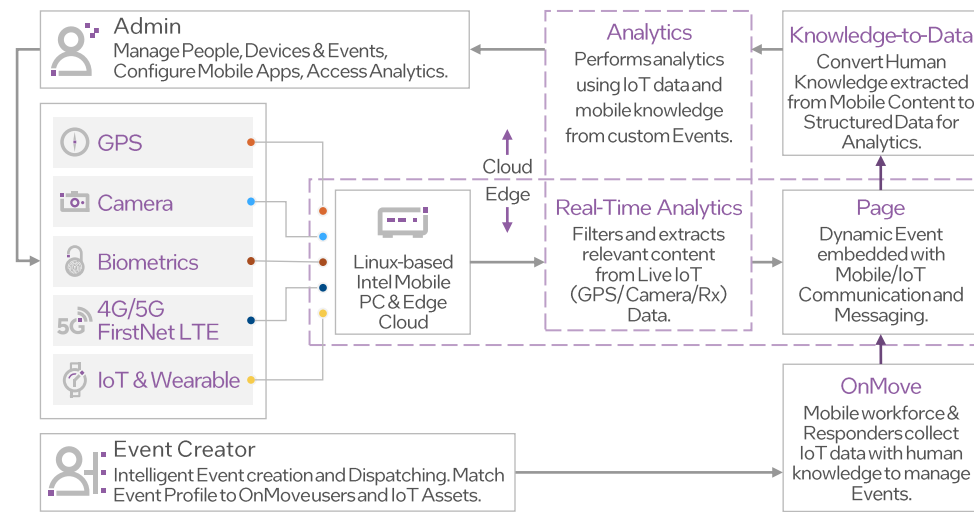

## Target Vertical:

Government, Health & Life Sciences, Retail, and Transportation

## Secondary Verticals:

Public Safety, Private Security, Mobile Workforce, Logistics & Tracking, and Smart Cities

## Target Use Cases:

Situational Monitoring, Unified Communication, Human Wellness Monitoring and Safety, Fleet & Asset Optimization, Real-Time Operational Analytics, and Environmental Monitoring

## Geo Availability:

Americas, Europe, and UK

## Learn More:

- [beamLive Website](#)
- [beamLive Products Page](#)

# Xiaoshentong Toll Vehicle Identification and Management Solution Based on Intel Architecture

## Solution Overview

The solution utilizes edge computing, AI image recognition, and other technologies integrated with smart cameras, smart fill lighting, IoT monitoring, and radar sensors to provide valuable insights displayed on an intuitive dashboard. Through patented multi-feed 3D vehicle identification technology, the system analyzes the collection of frontal, side, and rear vehicle features and the analysis and restoration of vehicle body (length, number of axles, wheelbase, axle type, number of wheels, side features, etc.) features to provide key supporting data for the classification of vehicle types, along with the comparison and analysis of various vehicle body features. All vehicle license plate and identifying information is encrypted.

## Value Props

- Enhance inspection accuracy** with a solution that helps mitigate toll misjudgments and supports anomaly detection
- Increase revenue** with improved object and vehicle recognition to realize accurate toll station pricing
- Optimize operations** by automating the tolling process using artificial intelligence to remove errors from manual inspection and decrease inspection and transaction process time

## Kit Components

- Intel® Core™ processors
- Intel® Distribution of OpenVINO™ toolkit
- Intel® Movidius™ Myriad™ VPUs

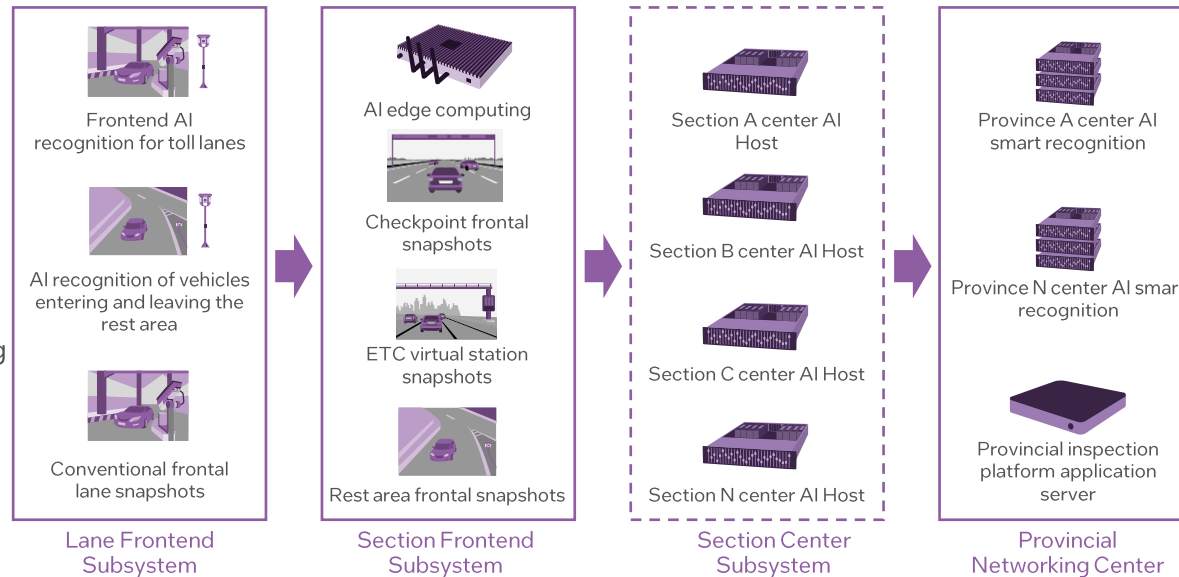

**Target Vertical:**  
Transportation & Warehousing

**Target Use Case:**  
Asset & Operations Optimization

**Geo Availability:**  
Peoples Republic of China

## Learn More

- [Xiaoshentong Website](#)
- [Beijing Sinoits Technology Website](#)

# Beijing Winsense Technology Co. Ltd. Retail Store

## Solution Overview

Retailers, including 4S automotive dealerships, are constantly looking to gain a competitive edge with deeper insights that can help them enhance the customer experience and improve management and efficiency. The Winsense Retail Store MRS is a vision AI retail solution that processes real-time information on shopper characteristics and behaviors, property attributes, vehicles, and on-site details to provide intelligent insights for better business decision making. With Winsense software, retailers can leverage the data insights for internal management, risk management, business analysis, and client management to help improve overall sales strategies.

## Value Props



**Enhance the customer experience** by leveraging insights from the behavioral semantics AI to make bespoke sales pitches and shopping experiences



**Increase profits** with a solution that decreases labor costs and helps managers gain efficiencies using Winsense's business tools



**Improve decision making** with Winsense's software which helps businesses analyze and understand areas of concern to make better strategic decisions

- ReID Recognition
- Identity binding
- Flow capturing



- Adapt to multimedia applications
- Knowledge processing
- High-speed computing



- Service Control
- Device Management
- Edge Computing



- Internal Management
- Risk Management
- Business Analysis
- Client Management



- Large-scale Computing
- Platform (real time/offline)
- Business Middle Desk
- Distributed Management & control platform
- Data Middle Desk/ Open VINO

## Kit Components

- Intel® Core™ i7 Processors
- Intel® Core™ i5 Processors

**Target Vertical:**  
[Retail](#)

**Secondary Vertical:**  
[Other](#)

**Target Use Case:**  
[Situational Monitoring](#)

**Secondary Use Case:**  
[Logistics & Tracking](#)

**Geo Availability**  
 People's Republic of China

## Learn More

- [Beijing Winsense Technology Website](#)



# BenQ DuoBoard Corporate Interactive Display

[Back Other Solutions](#)



[Back to Interactive Media Use Cases](#)



## Solution Overview

BenQ Corporate interactive displays help businesses develop and maintain an environment where ideas flow freely. It allows for extended, seamless team collaboration, and stimulating innovative ideas and is perfect for fostering collaboration then turning team creativities from abstract to real.

## Value Props

-  Foster a collaborative environment – Double collaboration space or run two operating systems concurrently
-  Empower employees to annotate anywhere and share notes/ideas from the office, at home, or on business trips
-  Leverage hassle-free management - through DMS Cloud and use NFC technology to help secure user access

## Intel Components

- Intel® Core™ i5 Processors
- Intel® Core™ i7 Processors

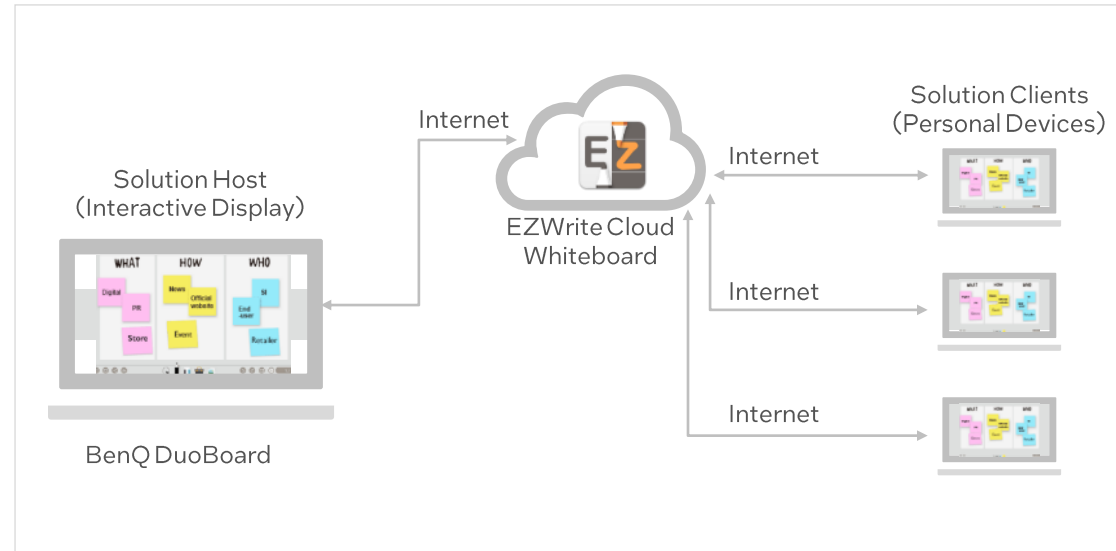

Target Vertical: Other

Secondary Vertical: Corporate; Education

Target Use Case: Interactive Media

Secondary Use Case: Collaboration

Geo Availability Globally

## Learn More

- [BenQ Corporation - Intel® Solutions Marketplace](#)
- [BenQ Display Solutions | BenQ Business US](#)
- [BenQ contact page](#)



# Berry AI, Inc. AI-based Timer System

## Solution Overview

Restaurant owners and operators are often unable to take full advantage of the data being captured by their security cameras to measure the speed of service and improve store performance. Other traditional methods, such as loop timers, mystery guests, and stopwatches also provide limited insights and do not completely and accurately measure speed and efficiency. Berry AI Inc.'s AI-based Timer System collects video data of customers in various stages of the customer transaction process, including queuing, ordering, and waiting for food to provide actionable insights for restaurant operators to improve service speed and performance, identify bottlenecks, increase productivity, and enhance the overall customer experience.

## Value Props



**Maximize ROI** by leveraging an AI-based Timer System that accurately captures total service time across all phases of the customer journey to provide actionable insights that can reduce wait times and lost sales due to walkouts



**Improve customer experience** by deploying a solution that analyzes video data to deliver real-time insights via a dashboard that enables restaurant operators to enhance the customer journey across all channels



**Enhance security** across multiple locations with a solution that integrates as a complete security system, imbuing both existing and new infrastructure with advanced monitoring and protection features

## Intel Components

- Intel® Distribution of OpenVINO™ Toolkit
- Intel® Core™ Processors
- Intel® Atom Processors

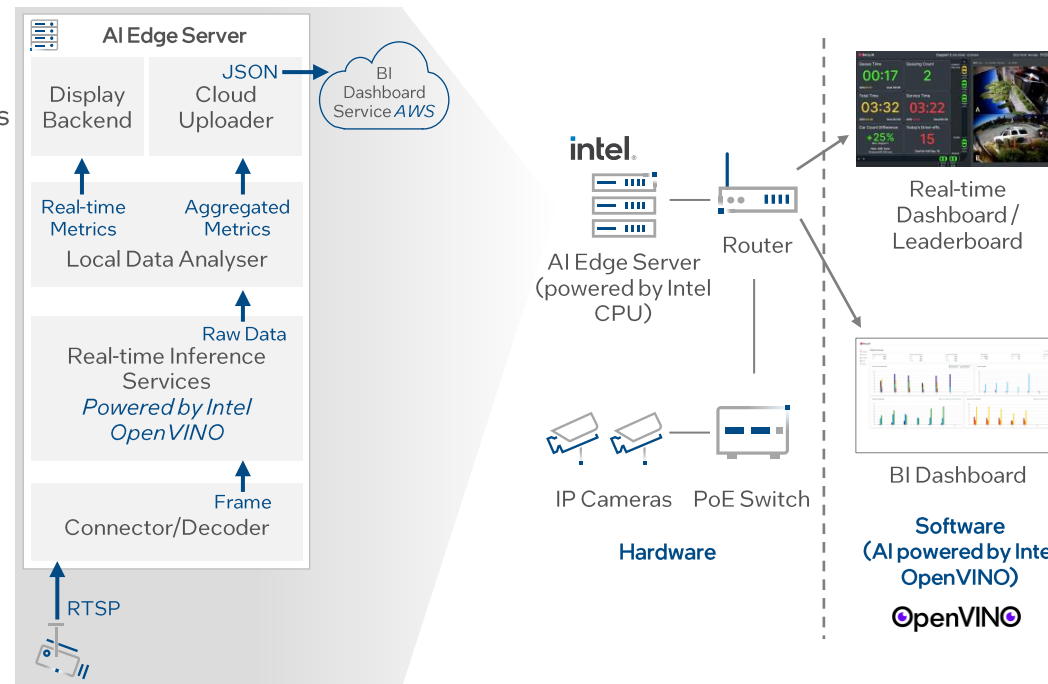

**Target Vertical:**  
Hospitality and Restaurants

**Secondary Vertical:**  
Retail

**Target Use Case:**  
Asset & Operations Optimization

**Geo Availability**  
APJ, Americas, Europe, Middle East, and Africa

## Learn More

- Berry AI Demo
- Berry AI Website





# Biomedica DataSense

## Solution Overview

Medical institutions and research labs need high performance computing capabilities to manage complex data workflows. The Biomedica DataSense solution provides healthcare professionals with high-yielding data processing capabilities while integrating and securing clinical workflows for disease detection analysis. Medical professionals can leverage the AI training and models in DataSense to create a personalized diagnostics system to treat patients and practice precision medicine, which considers patients' individuality.

## Value Props

-  **Improve patient care** with an AI screening solution to support healthcare professionals to overcome challenges during clinical examinations and improve preventative healthcare.
-  **Optimize workload management** with a flexible, all-in-one solution that integrates existing workflows for centralized data analysis and AI model training
-  **Lower overhead costs** with a one-stop, plug and play solution suitable for data management needs across the medical field that reduces IT management demands

## Intel Components

- Intel® Xeon® Scalable Processors
- Intel® Core™ Processors
- Intel® Iris® Graphics
- OpenVINO™ Toolkit
- Intel® Movidius™ Myriad
- Intel® Distribution of Intel® oneAPI

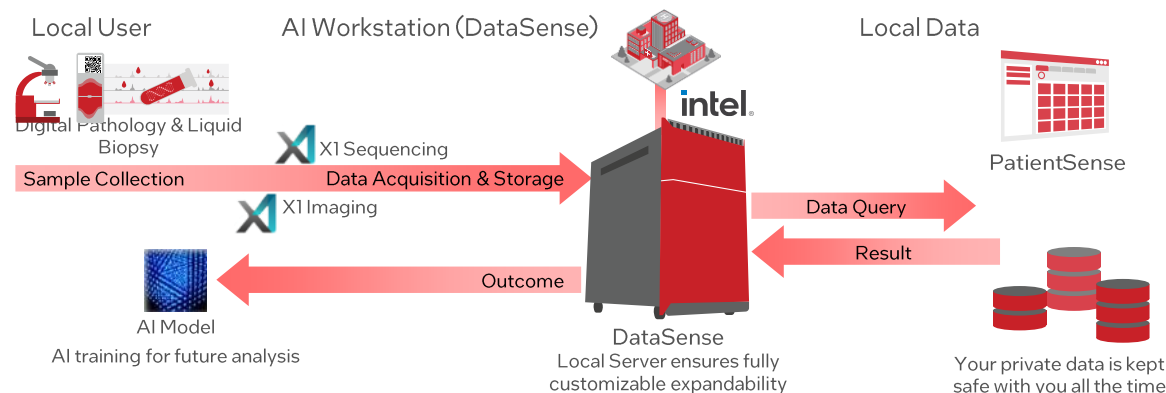

**Target Vertical:**  
Health & Life Sciences

**Target Use Case:**  
Human Wellness Monitoring

**Geo Availability**  
Global

### Learn More

- [Biomedica Website](#)
- [Biomedica DataSense Webpage](#)



# Biomedica Osteoporosis Screening Kit

## Solution Overview

The standard method of screening for osteoporosis, DXA, can be difficult and uncomfortable for elderly and injured patients, as the examination takes at least 15 mins and requires patients to hold still during it. The Biomedica Osteoporosis Screening Kit provides a simpler and faster solution for osteoporosis screening that only uses a simple hip x-ray from SEXA, which is available in every hospitals, and generates a report showing the patient's T-score and osteoporosis risk evaluation. The screening process complies with standard medical guidelines for diagnosing osteoporosis, testing bone mineral density, and simultaneously assessing for the presence or risk of fractures.

## Value Props



Streamline osteoporosis screening, by leveraging edge AI software to cut the process length from 15+ minutes to 6 seconds, while also increasing medical cost savings by 50%.



Enable early evaluation and detection of osteoporosis with a fraction risk assessment tool that aids in diagnosing and kickstarting treatment with a 95% accuracy rate.



Help increase medical accessibility in mobility scenarios with a kit made to withstand rugged environments that can be deployed in mobile 5G x-ray vans to serve different communities and rural areas.

## Proven Results

- **The situation:** Taipei Municipal Wanfang Hospital, one of the major screening hospitals for osteoporosis, found that a large portion of the population of its surrounding community suffered from osteoporosis, as well as sarcopenia (often related).
- **The solution:** The hospital worked with Biomedica to deploy the AI-assisted Osteoporosis Screening Kit solution to broaden screening capacity at its institution with high accuracy.
- **The results:** Since deploying the solution, the hospital has been able to improve accuracy and efficiency. The solution's AI-assisted x-ray technology has nearly doubled the osteoporosis detection rate, helping doctors intervene and provide treatment before it is too late.

## Intel Components

- Intel® Core™ i5 Processors
- Intel® Xeon® Processors
- Intel® Movidius™ Myriad™
- Intel® Iris® Xe Graphics

**Target Vertical:**  
Health & Life Sciences

**Target Use Case:**  
Human Wellness Monitoring

**Geo Availability:**  
APJ

## Learn More

- [Biomedica Osteoporosis Screening Kit - Solution Webpage](#)



# BirminD B-Wise B-Cloud AutoML

## Solution Overview

The BirminD B-Wise and B-Cloud AutoML solution helps customers analyze shop floor data in real time to detect anomalies, predict equipment behavior, utilize PID control loop optimization, create digital twins, and more to enable the optimization of factories, prevention of failures, increased revenue streams, and the ability to modernize manufacturing to Industry 4.0 standards.

## Value Props



Improve factory floor efficiency with a solution that automatically analyzes equipment and products to detect anomalies and potential failures in real-time



Increase ROI and reduce costs with a reliable machine learning solution that identifies product anomalies faster and more accurately than manual inspection



Streamline factory management with a solution that collects and presents data in real-time to inform decision making

## Intel Components

- Intel® Core™ i3 Processors
- Intel® Xeon® E5 Processors
- Intel® Core™ i5 Processors

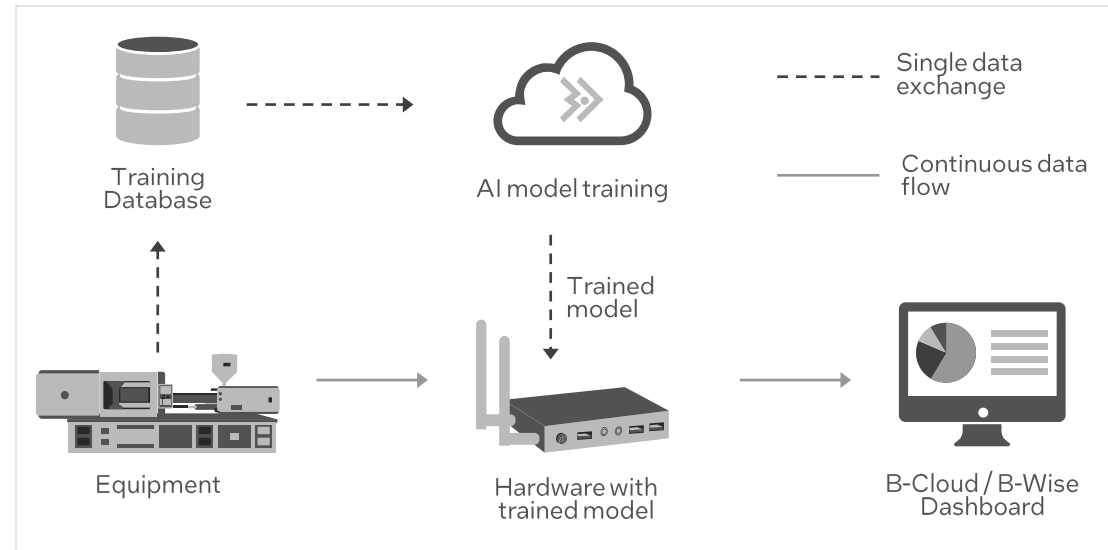

### Target Vertical:

Manufacturing

### Secondary Verticals:

Agriculture, Banking/Financial Services, Energy, Health & Life Sciences

Target Use Case: Asset & Operations Optimization

Secondary Use Cases: Control Optimization & Autonomy, Energy Monitoring & Mgmt., Machine Condition Monitoring

### Geo Availability

Available in Brazil, Canada, Mexico, United States, Other Americas, Australia, New Zealand, India, Japan, South Korea, China, Taiwan, Germany, Israel, Middle East, North Africa, Turkey Russia, Sub-Saharan Africa, United Kingdom

### Learn More

[BirminD Webpage](#)



# Bits & Bytes Thermal Detection Kiosk

[Back to Banking/FSI Solutions](#)

[Back to Situational Monitoring Use Cases](#)



## Solution Overview

The Bits & Bytes Thermal Detection Kiosk increases safety of staff and customers and streamlines operations through efficient temperature measurement. Visitors and employees walk up to a kiosk and get scanned for an elevated temperature without attendant intervention, and without touching the screen. It is equipped with an HD LED screen, a touch-free hand sanitizer pump, and an IR temperature sensor.

## Value Props



Provide efficient temperature measurement readings accurate to +/- 0.3 degrees!



Increase safety of staff and pedestrians through immediate notifications when a high temperature is detected



Improve operations with robust tracking of temperature measurements and any noted readings that would trigger a high temperature alert

## Intel Components

- Intel® Core™ i3 Processors
- Intel® Core™ i5 Processors

**Target Vertical:**  
Banking/Financial Services

**Secondary Verticals:**  
Government,  
Manufacturing, Retail

**Target Use Case:**  
Situational Monitoring

**Secondary Use Cases:**  
Human Wellness  
Monitoring, Product  
Inspection

**Geo Availability**  
Globally

## Learn More

- [Company website](#)

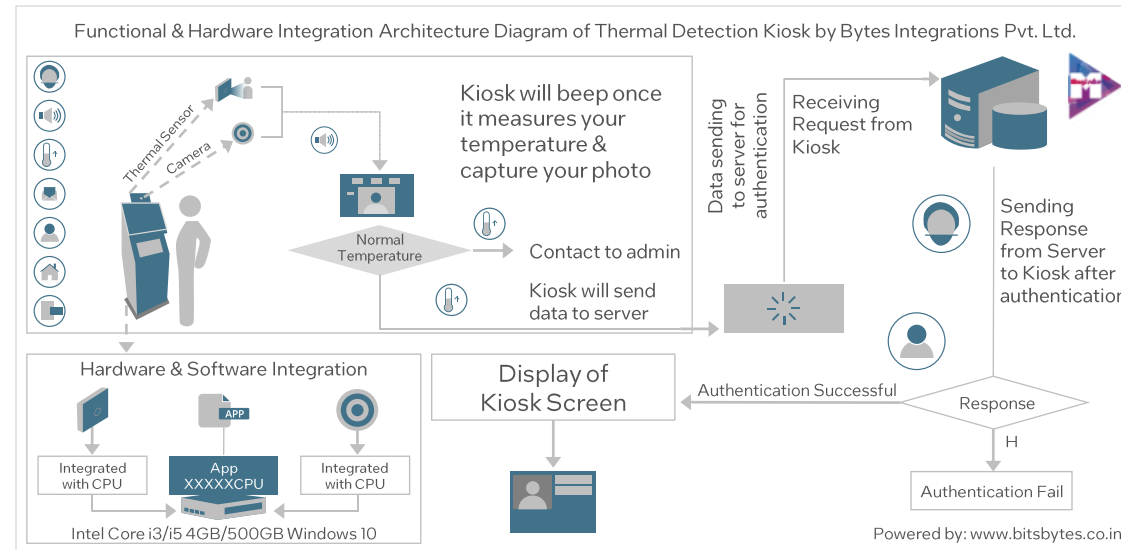



# Broox Platform

[Back to Retail Solutions](#)

[Back to Interactive Media Use Cases](#)



## Solution Overview

The Broox Platform supports the integration of experiential technology into retail spaces to enable businesses to create interactive customer experiences. As a cost-effective, Platform as a Service (PaaS) model, Broox can scale interactive plug & play technology that transforms any brand space.

## Value Props

- Transform brand experiences with a phygital platform connecting in-store technologies with online marketing stacks to create personalized interactions
- Leverage data analytics with offline availability by integrating out-of-the-box, plug & play interactive technology into a cloud-based online analytics platform
- Reduce costs and time to deployment with a single, unified phygital platform priced on a PaaS model with options for additional service integrations

## Intel Components

- Intel® Distribution of OpenVINO™ toolkit
- Intel® NUC
- Intel® RealSense™ Technologies
- Intel® VPU

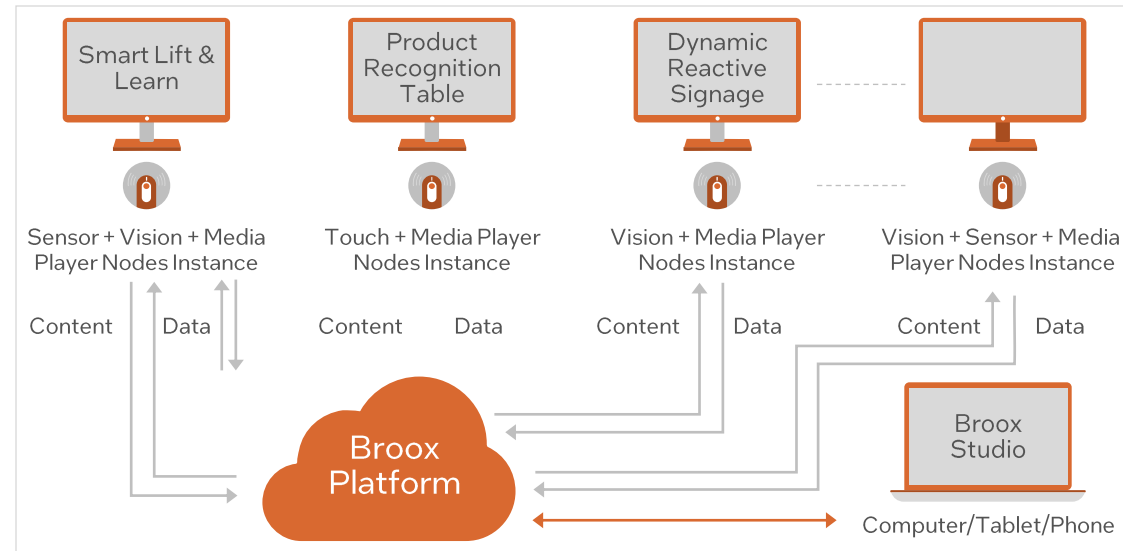

**Target Vertical:** Retail  
**Secondary Verticals:** Gaming & Entertainment; Government; Hospitality

**Target Use Case:** Interactive Media

**Geo Availability**  
 Brazil, Canada, United States, Other Americas, Australia/New Zealand, Japan, South Korea, Taiwan, Israel, Middle East, North Africa and Turkey, Sub-Saharan Africa, EMEA

**Learn More**  
[Broox Website](#)

# Bütema AG Digital Signage

## Solution Overview

Bütema AG is one of the leading full-service providers for digital signage and mobile ERP hardware and software. The linking of all digital points of contact leads to outstanding results in retail and wholesale. That is why we develop our software for desktop and mobile applications ourselves and provide all-round hardware and software service with in-house teams. As a hardware and software managed service partner, Bütema AG stands for the comprehensive, intelligent digitization of retail and wholesale.

## Value Props



**Optimize employee operations** through an InStore Assistant (ISA) that helps employees with day-to-day work like running stock management processes



**Generate increase revenue** by gathering and analyzing consumer data to increase sell-through rates and selling screen slots to 3<sup>rd</sup> parties to run their ad campaigns



**Improve customer engagement** and appeal to consumers with digital signage promotions and digital counter cards

## Intel Components

- Intel® Core™ i3 Processors
- Intel® Core™ i5 Processors
- Intel® Server GPU
- Intel® Ethernet Network Adapter
- Intel® Optane™ Memory

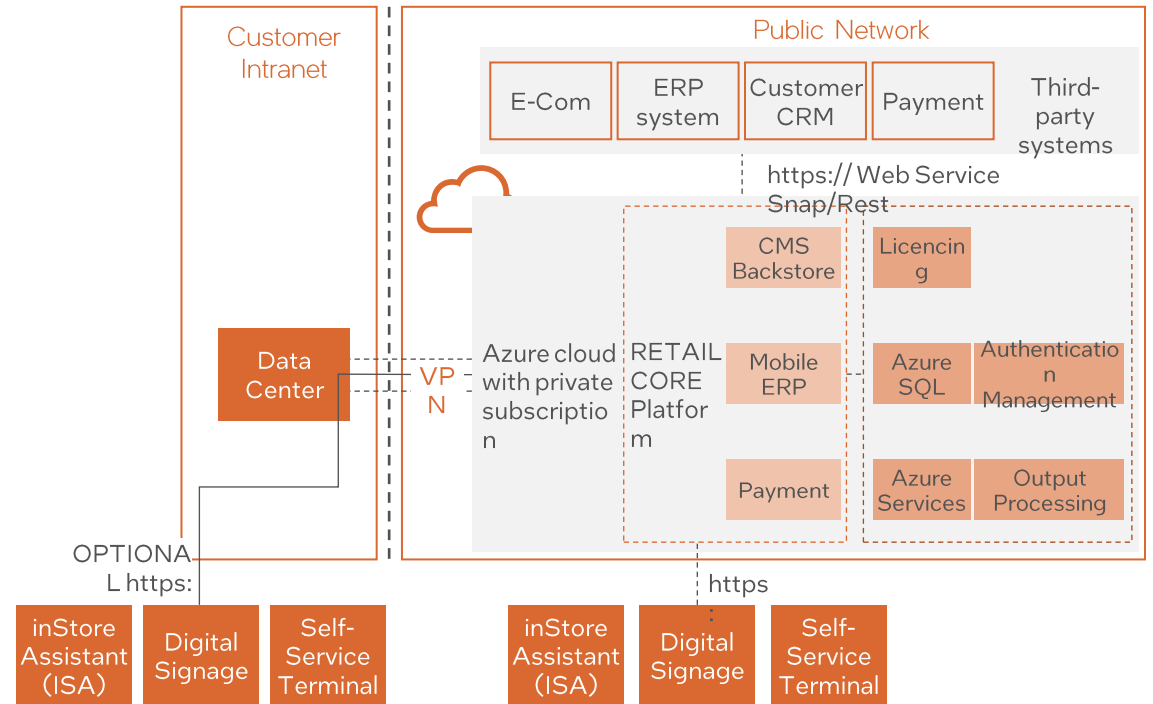

**Target Vertical:**  
[Retail](#)

**Target Use Case:**  
[Interactive Media](#)

**Geo Availability**  
 Europe, Middle East, and Africa

### Learn More

- [Social Retail Digital Signage – InStore Assistant](#)
- [Customer Success Story - BabyOne](#)

## CANCOM Smart Product

### Solution Overview

The CANCOM Smart Product Solution collects, aggregates, and visualizes sensor data, and runs that data against machine learning algorithms to identify quality issues and maintenance cases. These predictive insights, coupled with cutting-edge technology, allow companies to optimize and lengthen the life of their machines.

### Value Props



**Achieve better machine performance and longevity** from better insights into machine and plant operations via real-time and predictive analytics



**Improve operational efficiencies** via one centralized dashboard



**Reduce costs of machine downtime** with predictive maintenance that allows you to be readily equipped to handle maintenance more efficiently

### Intel Components

- Intel® Core™ i3 Processors
- Intel® Atom™ Processors
- Intel® Core™ i5 Processors
- Intel® Xeon® Processors

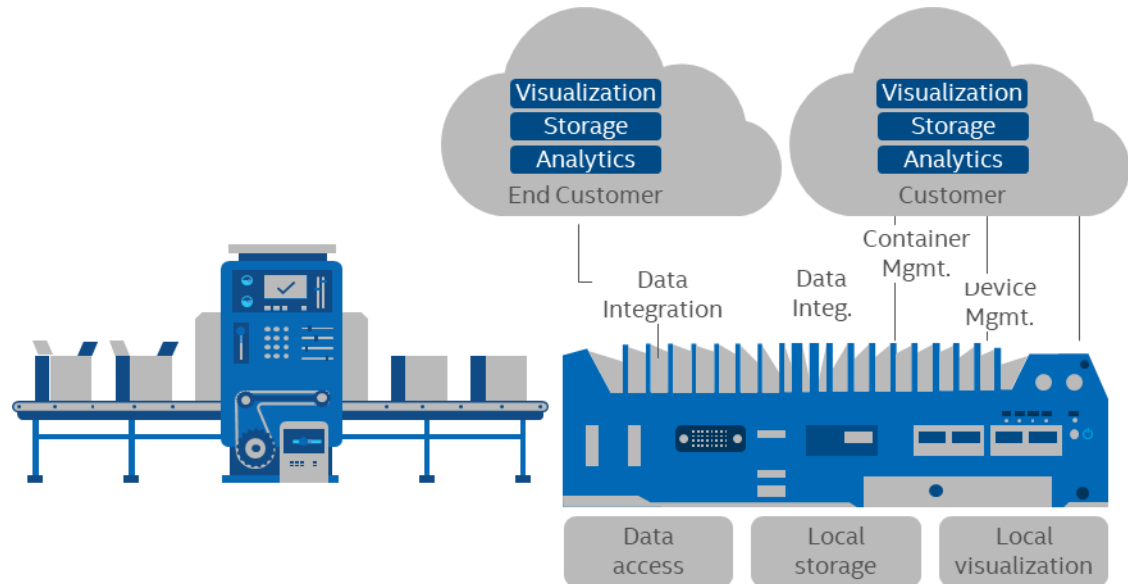

**Target Vertical:**  
Manufacturing

**Target Use Case:**  
Machine Condition Monitoring

**Secondary Use Case:**  
Product Inspection

**Geo Availability**  
Germany

**Learn More**  
CANCOM website



# CathexisVision – Video Security Management Solution

## Solution Overview

The CathexisVision solution addresses safety, security and operational effectiveness via a powerful set of customizable features. These features include video analytics, a variety of third-party system integrations, powerful video search tools and sophisticated event management on an intuitive graphical interface. This solution ultimately helps companies in a variety of markets minimize security risks, enhance decision-making, and improve operational efficiency. CathexisVision utilizes a variety of security techniques, including AES128 encryption for communicating between components, SHA512 hashes for login credential protection, and RSA1024 keys for securing video exports. Optional encryption is performed using AES128 block encryption with a randomized IV block and user generated passphrase.

## Value Props



**Simplify control room management** with flexible integrations of IP cameras and third-party systems, all managed from a centralized location



**Strengthen on-site security** with automated notification protocols to help operators make informed decisions and implement pre-configured actions



**Improve operational efficiency** by analyzing large amounts of data to help pinpoint incidents in real-time

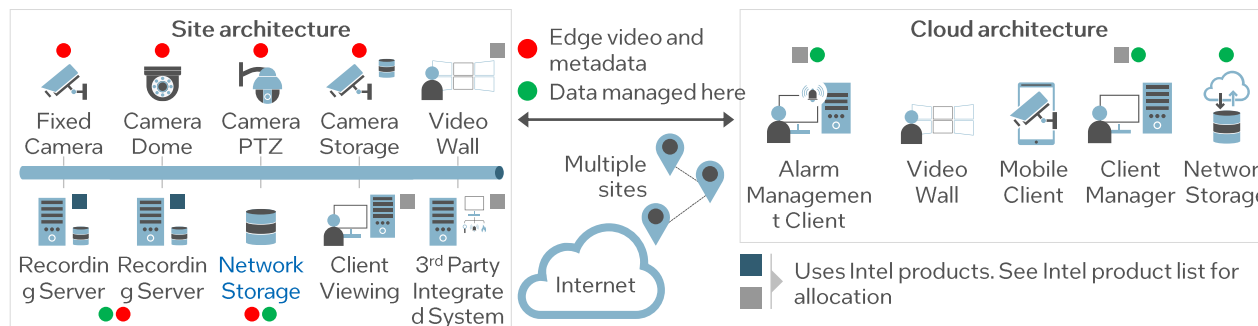

## Intel Components

- Intel® Core™ i3 Processors
- Intel® Core™ i7 Processors
- Intel® NUC
- Intel® Distribution of OpenVINO™ toolkit
- Intel® Xeon® Processors

**Target Vertical:**  
Education

**Secondary Verticals:**  
Safety and Security, Retail, Banking/Financial Services, Energy, Gaming & Entertainment, Government, Healthcare & Life Sciences, Hospitality, Manufacturing, Transportation and Logistics

**Target Use Case:**  
Situational Monitoring

**Geo Availability**  
North America, Asia Pacific, Central Southern and Eastern Europe, Middle East & North Africa, Southern Africa, United Kingdom

**Learn More**  

- [CathexisVision VMS Software Homepage](#)



### Solution Overview

Centerm Smart Banking Solutions are based on thin client and intelligent terminals, transforming banking experiences by making banking transaction quicker and easier

### Value Props

- Improve customer experiences through a simplified banking process that enhances on-site and mobile interactions
- Reduce operational costs with an efficient and easy-to-manage IoT platform
- Protect data privacy with security solutions that store, exchange, and deliver sensitive customer information

### Intel Components

- Intel® Xeon® Processor, Intel® Core™ i3, i5, i7 processors, Intel® Pentium® processor, Intel® Celeron® processor, Intel Atom® processor, Intel® Ethernet Controller
- Win 10 IoT\*, Centerm OS

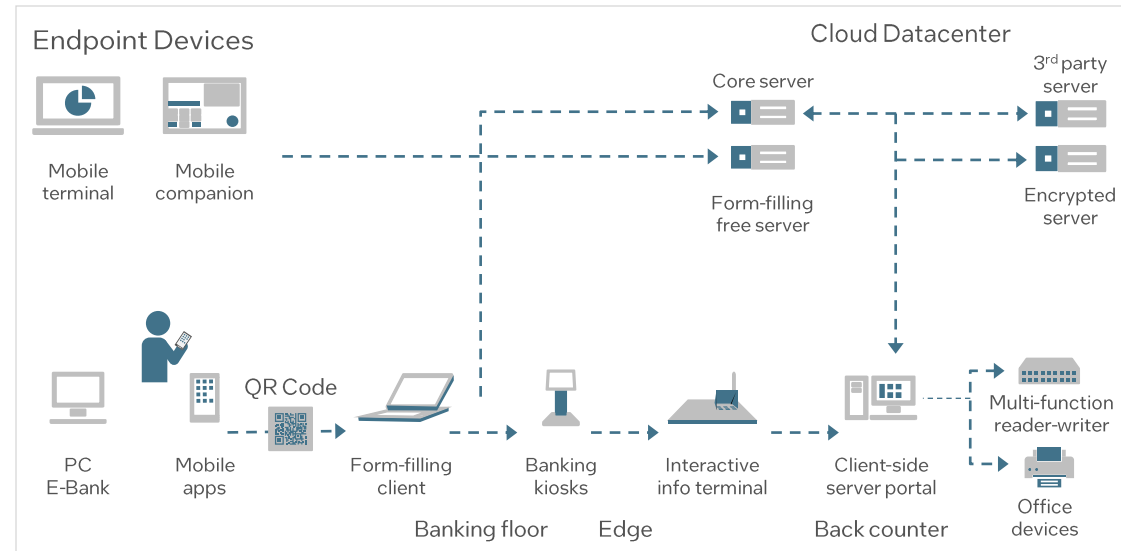

**Target Vertical:**  
Banking/Financial Services

**Secondary Verticals:** Retail, Education, Government

**Target Use Case:**  
Interactive Media

**Secondary Use Case:**  
Asset & Operations Optimization

**Geo Availability**  
PRC, APJ (Asia Pacific except Japan), Europe

**Learn More**  
▪ [Centerm Website](#)

# Centerm Weixun Intelligent Cloud Solution for School District

## Solution Overview

The Centerm Weixun Intelligent Cloud Solution for School District informatizes school districts in the PRC to enable education bureaus to make data-driven decisions that improve overall teaching and consolidates resources to make equitable the education standards across schools. The unified cloud platform integrates desktop virtualization to increase ease of access to resources, analyzes the resource requirements of each school to provide on-demand allocation and management, and distributes educational resources for collaboration and standardization in school settings. Thus, allowing school districts to focus their own time and resources on education and less on keeping up with IT development and maintenance.

## Value Props



**Foster collaboration** with a shared cloud resource system that allows for greater communication and education standardization



**Reduce costs** of capital investment and maintenance by leveraging a single teaching management platform for all schools



**Improve teaching efficacy** with access to student and teacher performance data so that weak points are identified and actively coached

**Target Vertical:**  
Education

**Target Use Case:**  
Asset and Operations Optimization

**Geo Availability**  
People's Republic of China

**Learn More**

- [Centerm Website](#)
- [News Article](#)

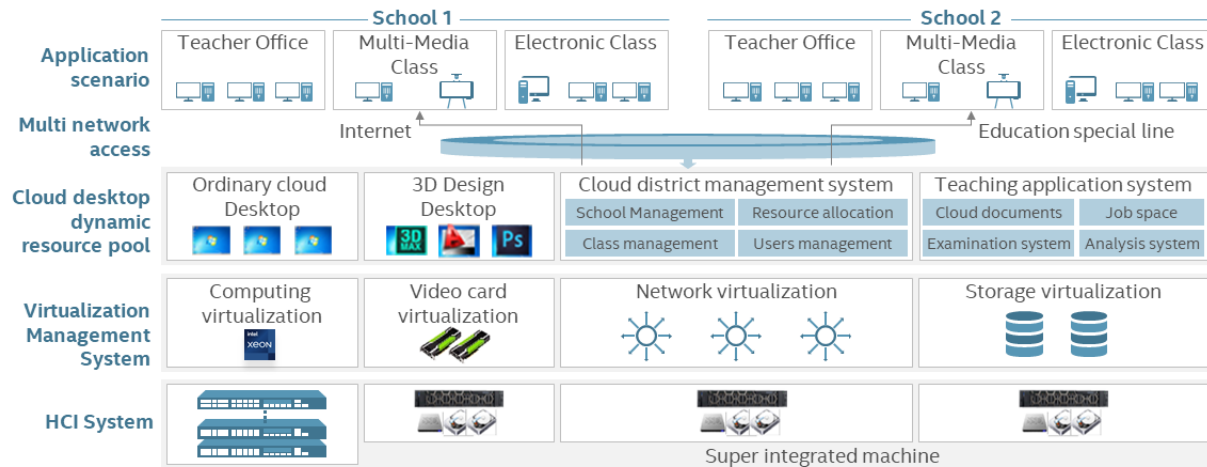

## Intel Components

- Intel® Xeon® Processors
- Intel® Celeron® Processors
- Intel® Core™ i3 Processors



# Cisco Smart Aviation and Airports

## Solution Overview

The Cisco Aviation and Airports solutions portfolio provides end-to-end supply chain connectivity by supporting intelligent cyber and physical security, automating the passenger experience, gaining real-time information, and streamlining ground operations, in order to increase efficiency and reduce costs

## Value Props



**Improve ground operations** by using an innovative collaboration suite that improves efficiency, mitigates errors, and help create better travel experiences



**Maintain constant situational awareness** through an airport monitoring solution that helps manage cybersecurity along with traveler and employee safety



**Increases aircraft turnaround efficiency** by synchronizing databases and live data from the edge through a rapid protocol management system

## Kit Components

- Intel® Xeon® Processors

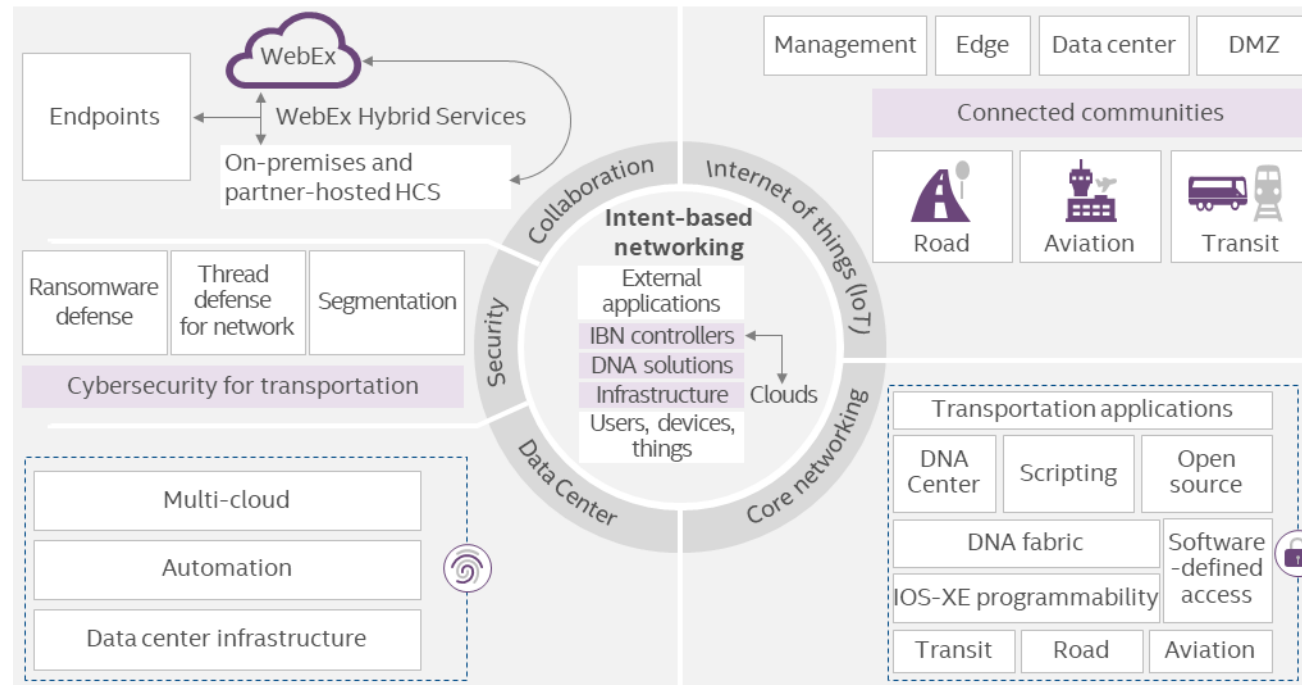

**Target Vertical:**  
[Transportation](#)

**Target Use Case:**  
[Situational Monitoring](#)

**Secondary Use Cases:**  
[Asset & Operations Optimization, Control Optimization & Autonomy, Human Wellness Monitoring, Product Inspection](#)

**Geo Availability**  
Global, APJ-T, Americas, EMEA, CIS, PRC

- Learn More**
- [Cisco Internet of Things \(IoT\) Products & Solutions](#)
  - [Portfolio Explorer for Transportation](#)
  - [Partner Locator](#)





# Cisco IP Fabric for Media

Back to Other Solutions

Back to Interactive Media Use Cases



## Solution Overview

The Cisco IP Fabric for Media solution allows customers to run video and audio signals on an IP-based infrastructure carrying multiple bidirectional traffic flows without requiring time-consuming and costly changes to the physical infrastructure. Switching from SDI to Cisco's IP solution results in increased bandwidth for the transmission of ultra high-definition content and provide better connectivity and media infrastructure security.

## Value Props



Reduce overhead costs associated with broadcast system management by simplifying data center networking and cabling requirements



Future proof your infrastructure with scalable, high density network support with zero packet loss, ultra-low latency, and minimal jitter



Increase operational flexibility with unified IP fabric for live broadcast and file-based media workflows

## Intel Components

- Intel® Xeon® D processors

### Cisco IP Fabric For Media

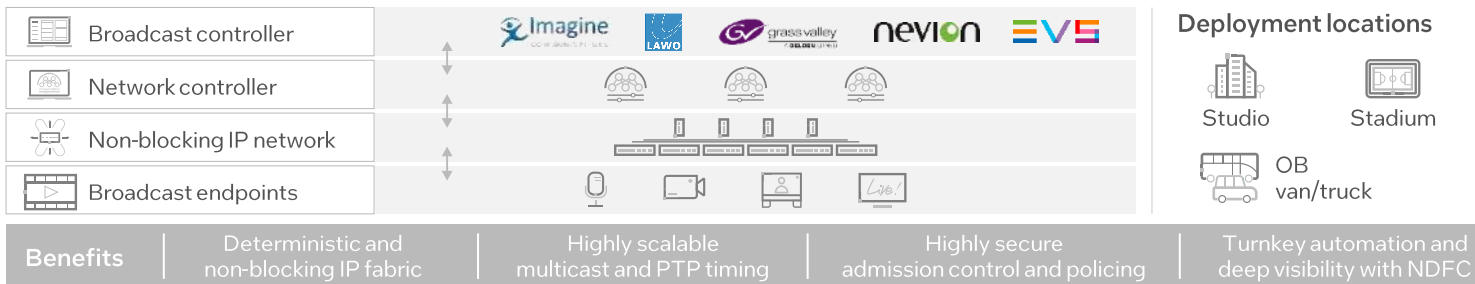

Target Vertical:  
Other

Additional Verticals:  
Gaming & Entertainment,  
Service Provider  
Networking, Media &  
Entertainment

Target Use Case:  
Interactive Media

Additional Use Cases:  
Situational Monitoring, Live  
Production, IP Based Media

Geo Availability  
APJ, Americas, EMEA, and  
People's Republic of China

### Learn More

- [IP Fabric for Media White Paper](#)
- [Cisco IP Fabric for Media Solution Webpage](#)



# Cisco Smart Buildings

## Solution Overview

The Cisco Smart Buildings solutions portfolio is a suite of services designed to measure occupancy, temperature, humidity, CO2, equipment health, security, utility and machinery management, and provide predictive operations to augment all aspects of facility control.

## Value Props



**Reduce industrial energy costs** by mitigating energy loss, unwanted thermal leakage, and greenhouse gas emissions.



**Enhance physical and digital security protocols** through a facility monitoring solution that also provides security teams with a suite of robust tools.



**Optimize facility operations** with an innovative collaboration suite that connects communications and edge devices to monitor live-time operational workflows.

## Kit Components

- Intel® Xeon® Processors

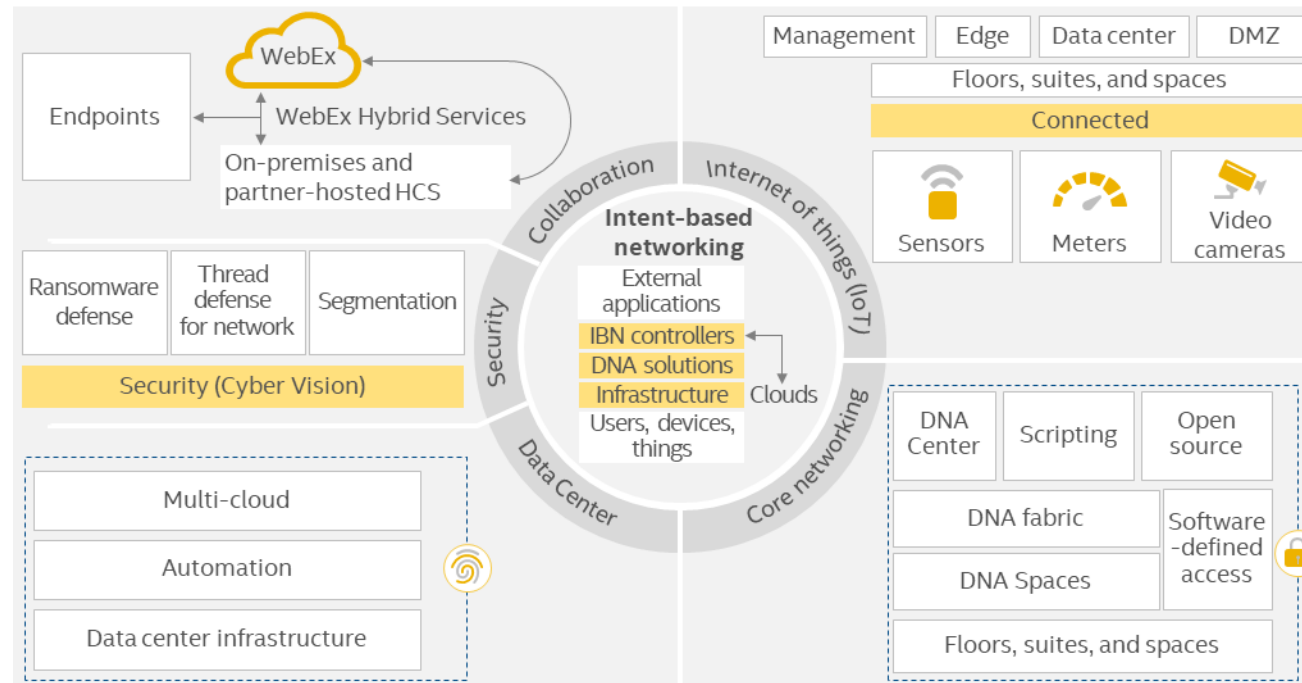

**Target Vertical:**

[Energy](#)

**Secondary Verticals:**

[Retail](#), [Banking/FSI](#), [Enterprise](#)

**Target Use Case:**

[Asset & Operations Optimization](#); [Environment Monitoring](#); [Situational Monitoring](#)

**Secondary Use Case:**

[Logistics & Tracking](#), [Control Optimization & Autonomy](#), [Human Wellness Monitoring](#), [Product Inspection](#)

**Geo Availability**

Geos: Global, APJ-T, Americas, EMEA, CIS, PRC

**Learn More**

- [Cisco IoT Products & Solutions](#)
- [Cisco Portfolio Explorer for Smart Buildings](#)
- [Cisco Authorized SI Partner Locator](#)



# Clevertouch Interactive Communication and Collaboration Solution

## Solution Overview

The Clevertouch Interactive Communication and Collaboration Solution offers a comprehensive and simple solution to enable blended learning environments and facilitate remote group collaboration. Clevertouch's Interactive Communication and Collaboration Solution makes it easier to distribute information and collaborate across physical-digital environments by smoothly integrating with existing technologies like mobile devices, tablets, laptops, and cloud business accounts. End customers can use Clevertouch Interactive displays, remote device management, built-in applications, assorted cloud capabilities, to connect stakeholders, improve operational productivity, and enhance learning environments.

## Value Props



**Enable easy collaboration** with a dynamic solution that deepens end user engagement by connecting relevant devices and environments



**Elevate operational performance** by streamlining the delivery of critical information to teams



**Scale and evolve** with a solution designed to meet changing business needs by providing simple deployment and integration options

## Intel Components

- Intel® Core™ i7 processors
- Intel® Core™ i5 processors
- Intel® NUC

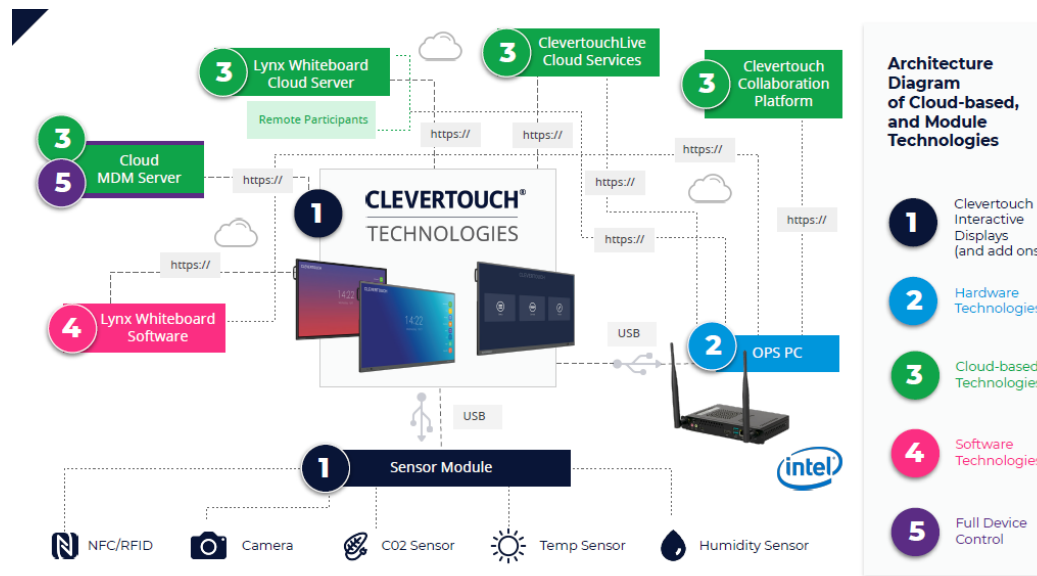

**Target Vertical:**  
Manufacturing

**Secondary Vertical:**  
Enterprise; Education;  
Banking/Financial Services;  
Energy; Government;  
Hospitality; Retail;  
Transportation

**Target Use Case:**  
Interactive Media

## Geo Availability

Available Territories and Regions: Brazil; Canada; Mexico; United States; Other Americas; Australia/ New Zealand; India; Germany; Israel; Middle East, North Africa and Turkey; Russia; Sub-Saharan Africa; Europe; Balkans; Nordic Region

## Learn More

- [Clevertouch Website](#)

# Cloudpick Autonomous Store

## Solution Overview

Cloudpick Autonomous Store, powered by Intel® technology, is an end-to-end smart retail solution that digitizes brick-and-mortar stores to bring customers a cashier-free, queue-free, grab-and-go shopping experience

## Value Props

- Increase operational efficiencies by reducing human error
- Save labor costs by introducing automation to the checkout process
- Improve customer experience by cutting wait time and minimizing staff dependency

## Intel Components

- Intel® Core™ i3, i7, and i9 Processors
- Intel® Media SDK
- Intel® Solid State Drives (SSD)
- Intel® Distribution of OpenVINO™ toolkit

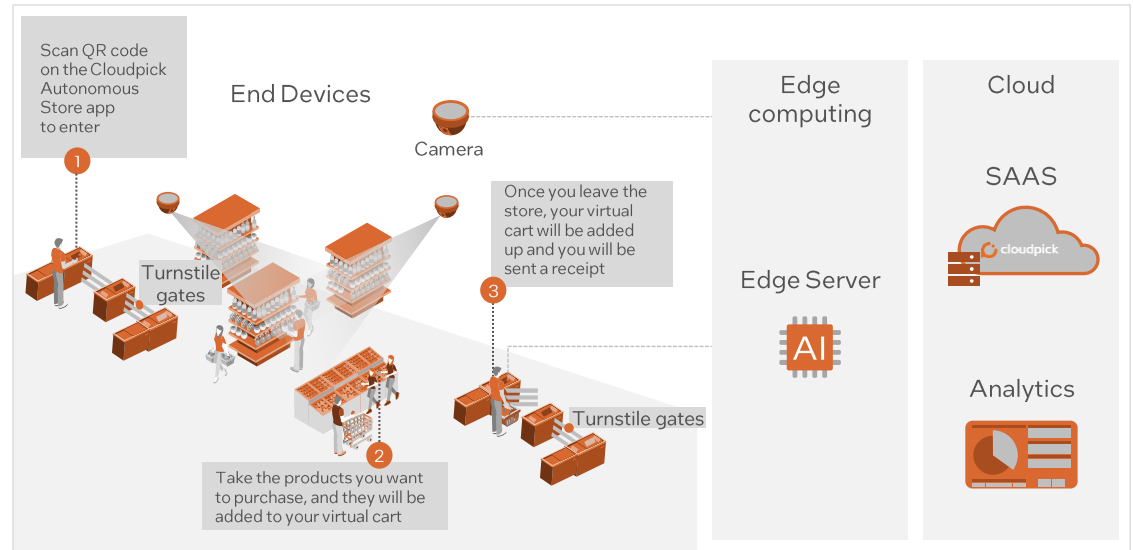

Target Vertical: Retail

Target Use Case: Asset & Operations Optimization

Secondary Use Cases: Interactive Media, Situational Monitoring

Geo Availability Globally

### Learn More

- [Cloudpick website \(Chinese\)](#)
- [Cloudpick's Youtube channel](#)



# ComQi Engage Platform

## Solution Overview

The ComQi EnGage Platform is a cloud-based digital signage content management solution (CMS) that helps customers connect, engage, and influence their shoppers

## Value Props



Maximize the impact of your content with customized messages curated for your audience to deliver the right message to the right screen at the right time



Gain insights from enterprise data on when, why, and how messages were delivered with EnGage reporting



Minimize strain on time and human resources with an intelligent content management machine that empowers customers to create, manage, and analyze content

## Intel Components

Intel® Core™ i7 vPro

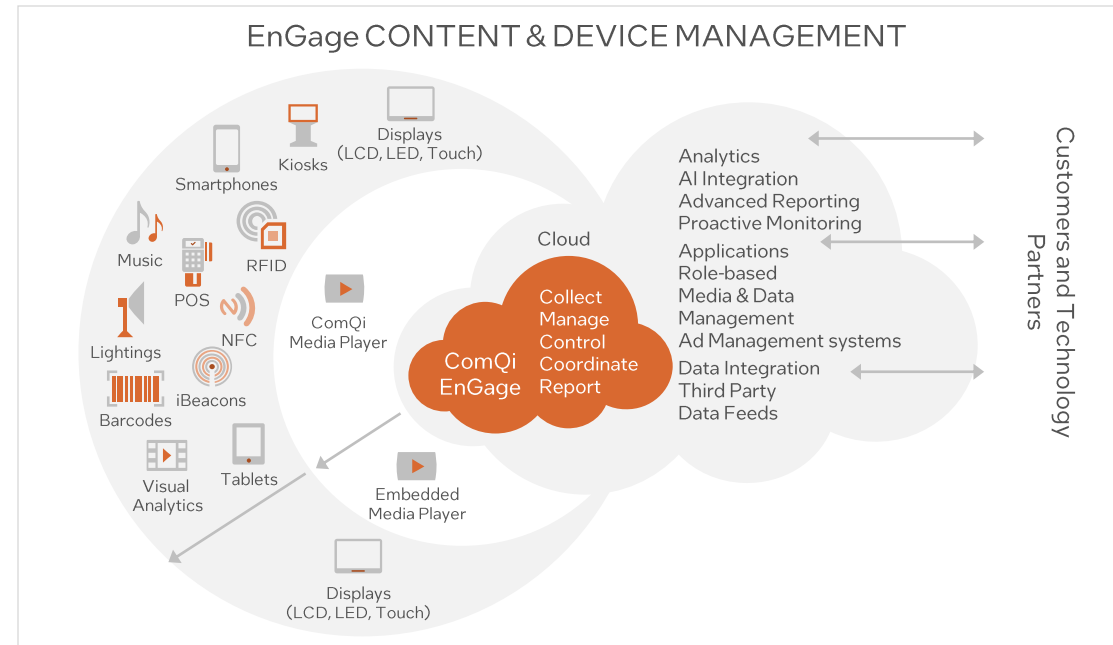

Target Vertical: Retail

Target Use Case: Interactive Media

Geo Availability: Globally

### Learn More

- [ComQi EnGage CMS](#)
- [Intel Solution Marketplace Page](#)

# Corsight AI Fortify

## Solution Overview

Corsight AI Fortify is an advanced facial recognition system that provides industry-leading accuracy in crowds and throughout a wide variety of challenging environments while prioritizing privacy. The solution helps improve security across a multitude of use cases including airports, gaming, law enforcement, smart cities, and entertainment venues.

## Value Props



**Help improve security** with a highly accurate, fast solution that allows facial recognition at scale in milliseconds, accelerating video investigations and enabling real-time alerts and decision-making



**Ensure privacy** as Corsight's signature technology enables facial recognition without the need to store sensitive data such as facial images and adheres to strict regional data privacy requirements (GDPR, LGPD, PDPA, etc.)



**Reduce costs** by removing the need for additional expensive hardware as Fortify can utilize existing ONVIF cameras and perform simultaneous facial recognition in large crowds

## Kit Components

- Intel® NUC
- Intel® Distribution of OpenVINO™ Toolkit

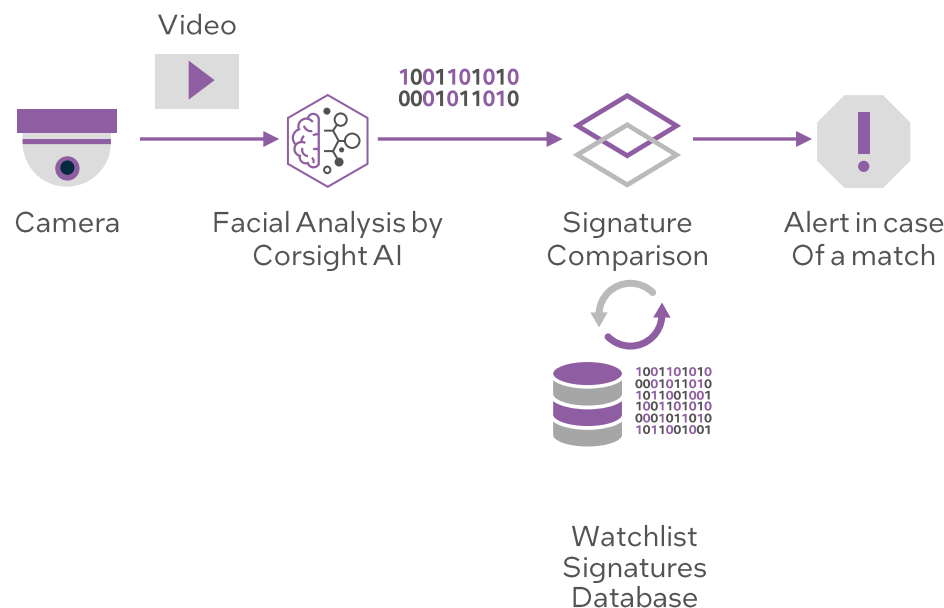

### Target Vertical:

Government

### Secondary Verticals:

Banking/Financial Services, Education, Energy, Gaming & Entertainment, Hospitality, Manufacturing, Retail, Transportation

**Target Use Case:** Situational Monitoring

### Secondary Use Cases:

Asset & Operations Optimization, Control Optimization & Autonomy, Environment Monitoring, Logistics & Tracking, Other

### Geo Availability

United States, Australia/New Zealand, India, Israel, Middle East, North Africa, Turkey, and United Kingdom

### Learn More

- [Corsight AI Website](#)
- [Corsight AI Fortify Solution Page](#)



# CO-WIN Co., Ltd.

# OnlineMAW – Content Management System of Digital Signage

Back to Retail Solutions

Back to Interactive Media Use Cases



## Solution Overview

Historically the integration of digital displays from interactive signage to video walls required a large budget, a skilled workforce, and significant time in order to build a system and create content. With CO-WIN's OnlineMAW Content Management System, building and publishing content on a network of high-quality displays is now easy and cost effective. Through this CMS, end-users can visualize, analyze, and share content, data, and insights through secured channels with others, or through other devices and signs in the network. Overall, the OnlineMAW CMS is easy to deploy, centralize, and help all stakeholders in digital content publication, while maintaining a smooth and effective system that helps customers reach their audiences with ease.

## Value Props



**Customize digital signage with precision** using an edge computing platform that seamlessly integrates AI, sensors, and other IoT devices to deliver content that's tailored to the target customer.



**Engage customers across social platforms** by publishing brand images and promotional videos, or by streaming real-time content to your target audience on YouTube, Instagram, and more.



**Count on a reliable, easy to use CMS** that provides an intuitive UX for content production and planning and requires minimal technical expertise to keep running smooth

## Intel Components

- Intel® Core™ processor family

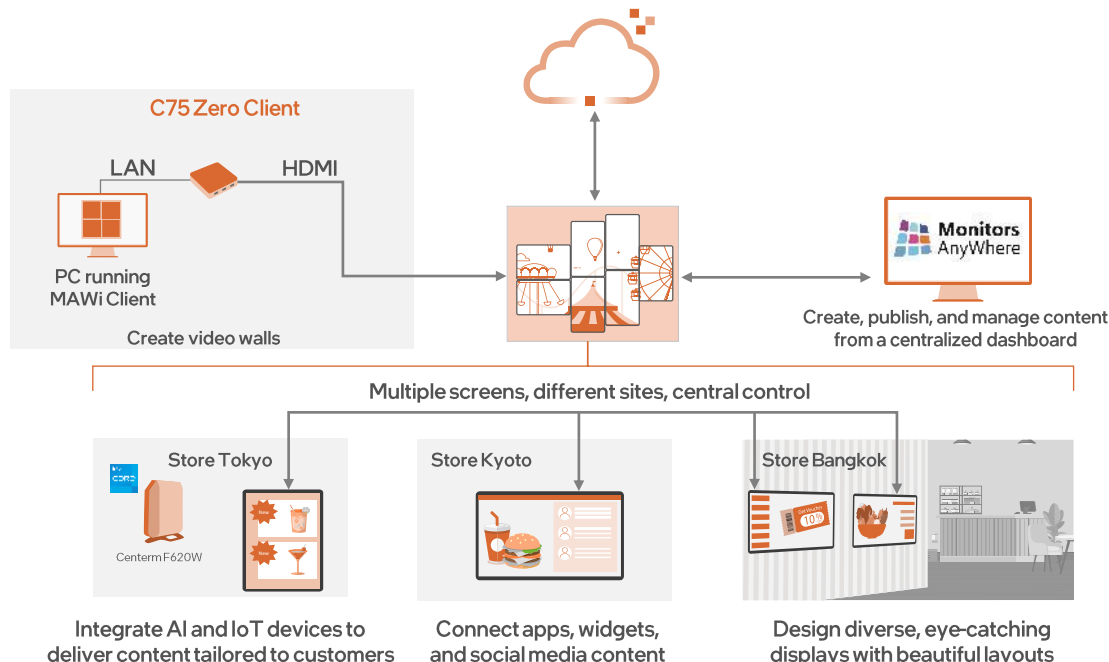

Target Vertical:  
Retail

Secondary Vertical:  
Government, Hospitality and Restaurants, Manufacturing

Target Use Case:  
Interactive Media

Secondary Use Cases:  
Situational Monitoring

Geo Availability  
Global

Sales Contact  
Aiko Nakahashi  
[aiko.nakahashi@cowin.co.jp](mailto:aiko.nakahashi@cowin.co.jp)

## Learn More

- [OnlineMAW - Solution Page](#)
- [Case Studies - Monitors AnyWhere](#)

# Crestron Collaboration Solution Refresh

## Solution Overview

The Crestron Collaboration Solution\* is an end-to-end, device-to-cloud solution that enables futureproof, flexible and efficient collaboration experiences in any space with flawless AV, distribution of 4k content, and key insights into workplace technology.

## Value Props



**Support different setups** with Crestron Flex built on Intel® Core™ i5 processor comprised of certified Microsoft devices to support any room size or type, to create a unified communication platform



**Share content instantly** with DM NVX built on Intel® FPGA Arria® Technology, that provides pixel perfect, 4K Video distribution, flawless audio, and control over a cost effective 1 Gigabit network



**Increase meeting productivity** with XiO Cloud built on Azure IoT Hub, that has the ability to capture usage and trend data providing key insights into how workplace technology is impactful

## Intel Components

- Intel® FPGA products
- Intel® Core™ i5 processors

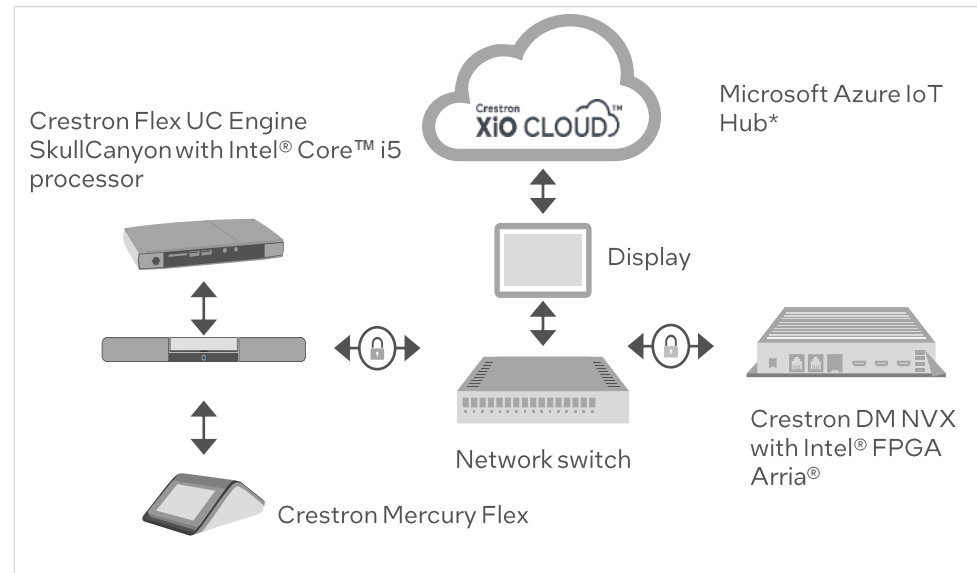

**Target Vertical:** Other

**Secondary Verticals:**  
Retail, Education,  
Government, Health & Life  
Sciences, Energy,  
Hospitality and Restaurants,  
Transportation and  
Warehousing

**Target Use Case:** Interactive Media

**Geo Availability**  
 APJ, Americas, EMEA,  
 People's Republic of China

## Learn More

- Crestron Electronics [Homepage](#)
- Commercial and local [Dealers Here](#)
- Representatives [Here](#)
- Showroom and [Experience Centers Here](#)



# Crown Digital - Ella: The Robot Barista

## Solution Overview

Ella, a robotic barista developed by Crown Digital, is an autonomous retail solution powered by robotics and AI. With a small footprint of 6m<sup>2</sup> the solution saves retail space, increases production capacity, and offers a truly seamless retail experience for customers. Ella is supported by a powerful backend architecture that manages multitudes of Ellas remotely via a command center and can predict needed maintenance and optimize the supply chain upstream and downstream. Ella also offers immersive 4K targeted advertising via its Transparent OLED screens creating myriad cross selling opportunities.

## Value Props



**Reduce cost**—Occupying ~5m<sup>2</sup>, the unit takes up a fraction of the space required for a traditional coffee bar translating to a cheaper retail footprint



**Mitigate effects of labor shortages and staff turnover**—Fully unmanned, Ella frees up labor, allowing staff to be reassigned to other in-store tasks



**Increase beverage output and consistency**—Ella can prepare up to 200 cups of high-quality coffee an hour

## Kit Components

- Intel® Core™ i5 Processors
- Intel® Core™ i9 Processors
- Intel® Core™ i7 Processors
- Intel® Xeon® Processors

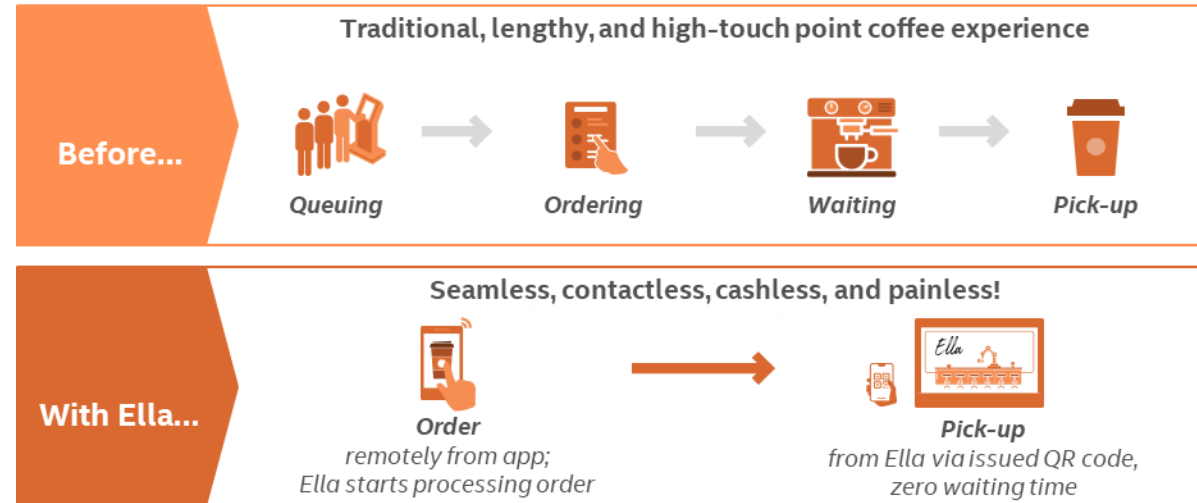

Target Vertical:  
[Retail](#)

Target Use Case:  
[Machine Condition Monitoring](#)

Geo Availability  
Global

Learn More  
▪ [Crown Digital Website](#)



# CVTE MAXHUB



## Solution Overview

The CVTE MAXHUB is a video conference solution designed to improve remote communication and collaboration productivity. It facilitates multiparty meetings for up to 100 participants and includes wireless screen sharing, file sharing, reverse control of laptops, and an all-in-one interactive panel acting as a remote terminal to offer MAXHUB capabilities, including access control, cloud storage, intelligent illustration, and speech-to-text.

## Value Props

- Optimize collaboration with an interactive panel offering real-time annotations, visual and audio hardware, and remote capabilities designed to drive productivity
- Use with ease by integrating with third-party software and quickly displaying content via wireless screen and file sharing
- Reduce costs with front screen installation and easily accessible disassembly to simplify hardware repair and updates

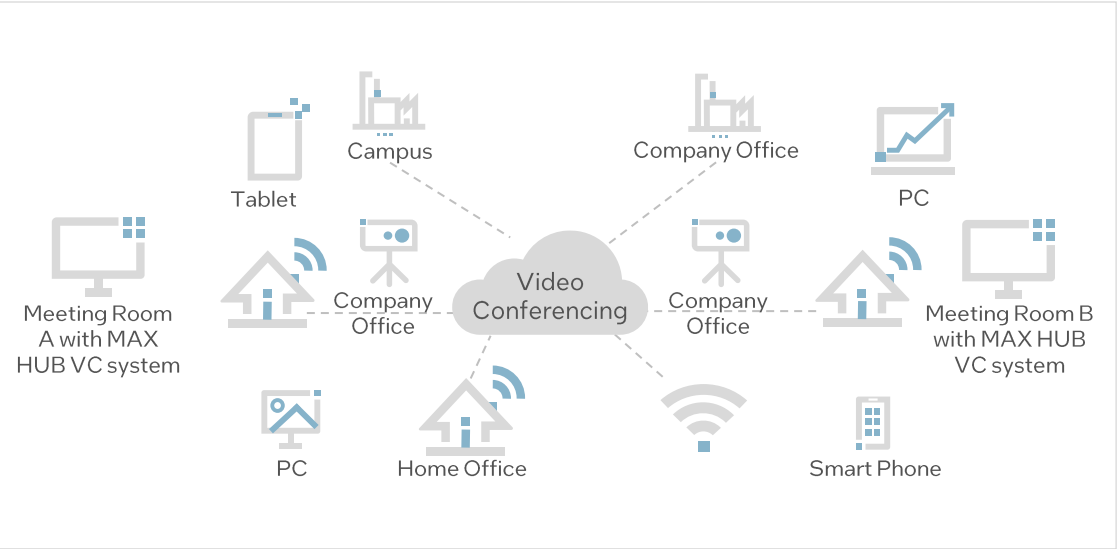

**Target Vertical:** [Education](#)  
**Secondary Verticals:** [Banking/Financial Services](#), [Government](#), [Hospitality](#)

**Target Use Case:** [Interactive Media](#)  
**Secondary Use Cases:** [Situational Monitoring](#)

**Geo Availability**  
Globally

**Learn More**  
[MAXHUB Website](#)

## Intel Components

- Intel® Core™ i5 processors
- Intel® Core™ i7 processors

# Deep Insights

## Solution Overview

Deep Insights is an end-to-end AIoT solution. Increase the intelligence and safety of your community through AI, IoT, and connectivity. With this solution, community operators can gain real-time insights to help create smart and safe environments.

## Value Props



**Provides an end-to-end solution** with everything you need, from cameras, IoT sensors, and edge/cloud/MEC compute to daily dashboards and reports



**Enables AI + IoT connectivity** by combining 4G/5G connectivity with IoT sensors and cutting-edge AI to predict, notify, and constantly learn



**Simplifies budgeting** with predictable costs and recurring monthly plans

## Kit Components

- Intel® Core™ i5 Processors
- Intel® Xeon® Processors
- Intel® Core™ i7 Processors
- Intel® Distribution of OpenVINO™ Toolkit
- Intel® Core™ i9 Processors

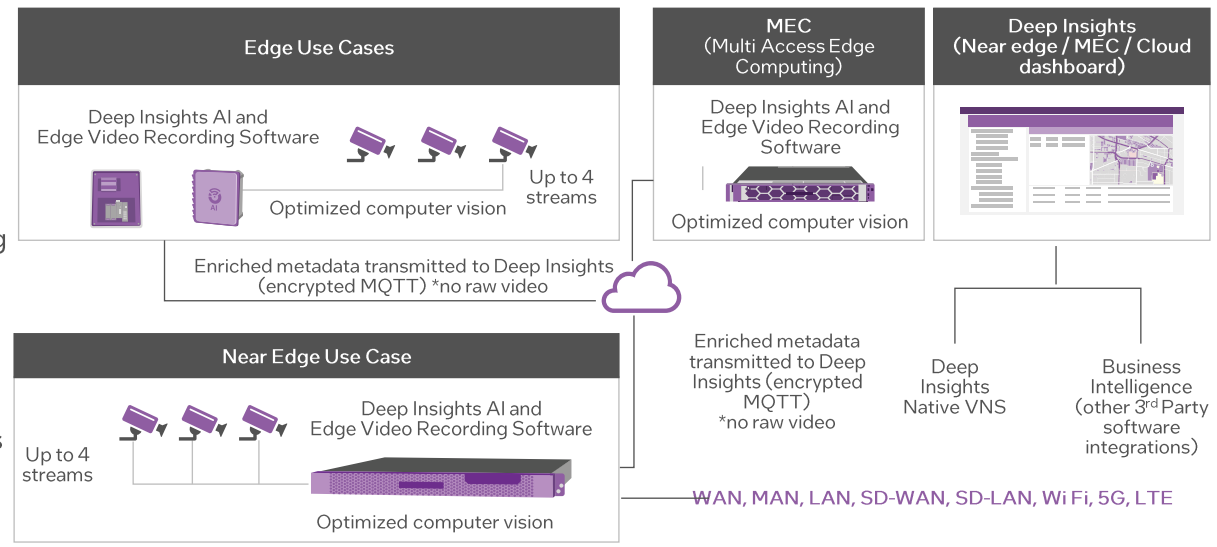

## Target Vertical:

Government

## Secondary Vertical:

Agriculture, Banking/Financial Services, Education, Energy, Gaming & Entertainment, Health & Life Sciences, Hospitality, Manufacturing, Retail, and Transportation

## Target Use Case:

Situational Monitoring

## Secondary Use Cases:

Asset & Operations Optimization, Product Inspection

## Geo Availability

Globally

## Learn More

[EPIC IO Homepage](#)



# Dell Grid Management Platform for Schneider Electric EcoStruxure™ ADMS Applications

## Solution Overview

Electric grid management has become increasingly complex and costly, with limited visibility into planning and optimizing operations. The Dell Grid Management Platform leverages Schneider Electric EcoStruxure™ Advanced Distribution Management System (ADMS) Applications to provide a standard and validated solution for customers to operate their electric grid to optimize overall performance and deliver key electric grid management capabilities for Transmission and Distribution (T&D) management, forecasting, outage management, and more.

## Value Props



**Improve grid resiliency** through a modern virtualization infrastructure platform which is optimized specifically to ensure high visibility, performance, and reliability



**Reduce total cost of operations** with the virtualization of utility grid management systems, allowing for the decoupling of application and hardware refresh cycles, and automated operations



**Improve life-cycle management capabilities** with automated administrative and maintenance activities, lowering costs while enhancing data security, compliance, and data protection services

## Intel Components

- Intel® Xeon® Processors
- Intel® Network Adaptors
- Intel® Optane™ Memory

A virtualized appliance from Dell Technologies that is validated, and performance optimized to run Schneider Electric's EcoStruxure™ ADMS Grid Software



ADMS

DMS

OMS

EMS

VMware Virtualization

Dell vSAN Ready Infrastructure

PowerEdge Platform Nodes, intel® Powered

### Validated Architecture Principles

- All-Flash Appliance with Multiple Disk Groups for High IOPS
- Storage groups with Fault Tolerance for High Availability and Performance
- Software defined storage replaces the need for a separate SAN
- Dell vSAN ready cluster using Intel Ice Lake CPUs
- 8-way memory interleaving for higher performance
- Provide high core count Intel x86 CPU with dense memory configuration

### Platform Solution Benefits

- Reliability: Designed for high performance and continuous availability of the ADMS
- Security: Designed to the NIST security framework an industry standard baseline
- Compliance: configuration settings required meet NERC CIP regulatory compliance
- Time to Production: Automated deployment and operations reduces the time to deploy new applications over legacy non virtualized application stacks.
- Lower TCO: reduction in cost of operations over traditional bare metal infrastructure deployments

### Target Vertical:

[Energy](#), Electric Utilities

### Target Use Case:

[Asset & Operations Optimization](#), Grid Modernization

### Secondary Use Case:

[Energy Monitoring & Management, Control Optimization & Autonomy](#), Mobile Grid Operations, Adaptive Protection

### Geo Availability

Global

### Learn More

- [Dell Technologies website](#)
- [Dell Technologies Grid Management Platform Common Design Architecture](#)



Back to Health & Life Sciences Solutions

Back to Human Wellness Monitoring Use Cases



# diagnext.com Diagserver Medical Communication System

## Solution Overview

diagnext.com's Diagserver Medical Communication System is a highly customizable solution compatible with most medical systems that enables the transmission of medical images and examinations to healthcare providers for faster diagnosis and treatment timelines.

## Value Props

- Enhance workflow performance with reliable transmission of data even when connections are unstable and interrupted
- Streamline delivery of services with an agile medical communication system that automates reporting
- Reduce costs of data storage with compressed DICOM available locally and in central cloud servers

## Intel Components

- Intel® Core™ i5 Processors
- Intel® Xeon® Processors
- Intel® Celeron® Processors

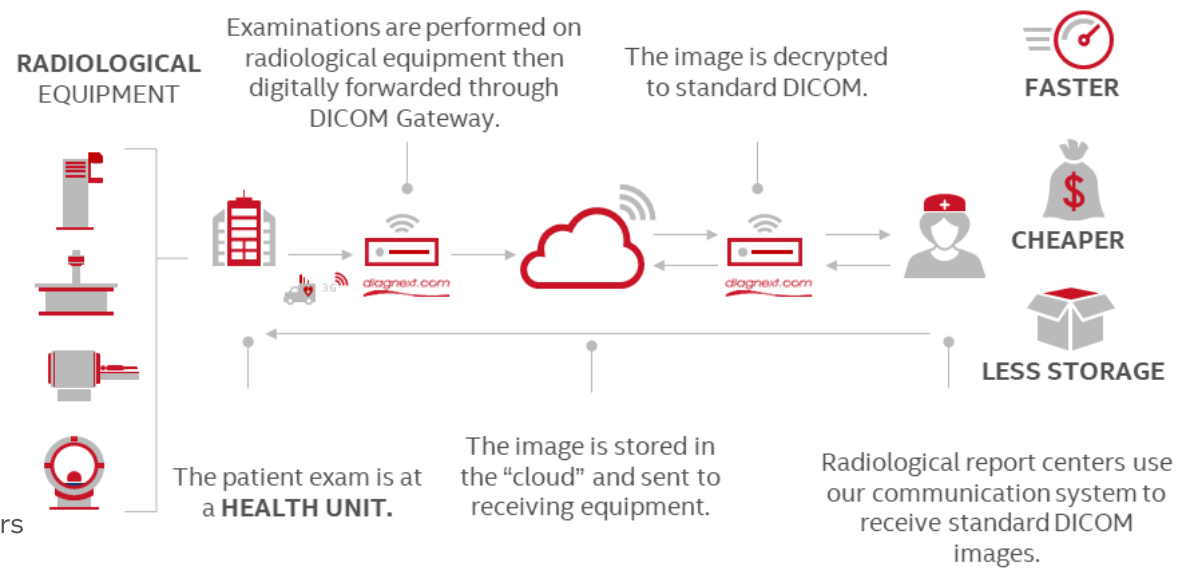

Target Vertical: Health & Life Sciences

Target Use Case: Human Wellness Monitoring

Secondary Use Case: Asset & Operations Optimization

Geo Availability: Brazil

### Learn More

- [diagnext.com webpage](http://diagnext.com/webpage)
- [diagnext.com solutions marketplace listing](http://diagnext.com/solutions/marketplace/listing)

# Diebold Nixdorf DN Series™ BEETLE A1150

## Solution Overview

The Diebold Nixdorf DN Series BEETLE A1150 provides a 15.6" all-in-one touchscreen point of sale terminal and kiosk system designed to be implemented at in-store checkout locations. The BEETLE A1150 features a common hardware platform consisting of interchangeable central processing units, display panels, and integrated peripherals that can be easily mixed and matched to enhance the retail customer experience. The solution utilizes powerful 8th Generation Intel® Core™ processors alongside solid-state disk storage media and interfaces to reduce overall power consumption, while encouraging speedy transactions at cashier checkpoints or kiosks. Additionally, the solution offers remote asset management and monitoring on the desktop management agent, BEETLEINFO, enabling more flexibility and control over assets.

## Value Props

**Meet changing business needs** with a flexible modular platform that can adapt into any store environment and be easily upgraded to accommodate future retail scenarios

**Lower total cost of ownership** with powerful, yet energy-saving technologies that reduce overall power consumption

**Increase store efficiency** by reducing interventions with a fan-less design, sealed housing, and easily managed, monitored, and serviced POS system

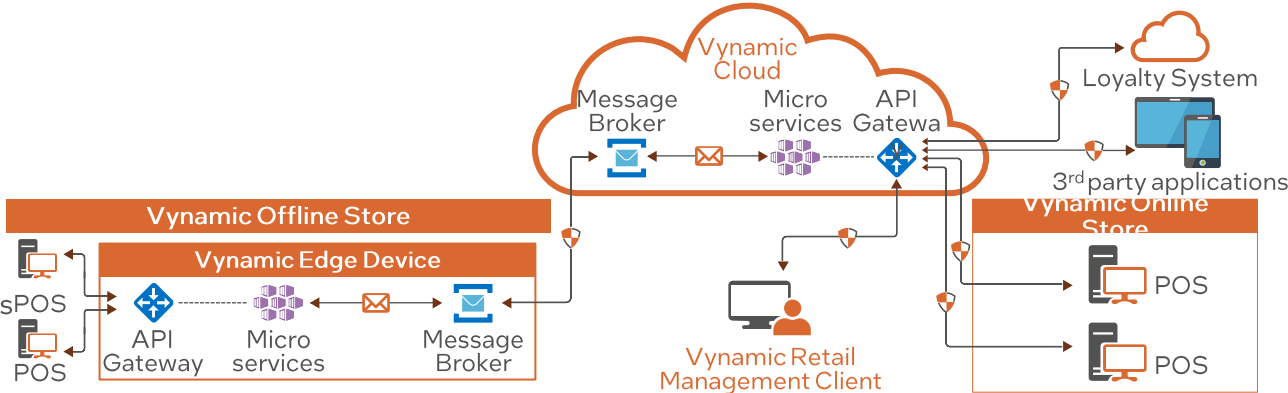

## Intel Components

- Intel® Core™ i5 Processors
- Intel® Core™ i3 Processors
- Intel® Celeron® Processors

**Target Vertical:**  
Retail

**Target Use Case:**  
Asset and Operations Optimization

**Geo Availability**  
APAC, Americas, and EMEA

- Learn More**
- BEETLE A1150 Product Card
  - Diebold Nixdorf - DN Series™ BEETLE Homepage



# DN AllConnect<sup>SM</sup> Data Engine for Data-Driven Intelligence

## Powering Actionable Insights

### Solution Overview

DN AllConnect Data Engine for customer-facing endpoints powers DN Maintenance Services to drive higher ATM availability and enable FIs to deliver against the expectations of their clients. The system identifies and tracks patterns that occur throughout the devices' lifecycles and builds a precise personality profile for each device. Each profile is continually refined based on further data collection and analysis to provide tailored, actionable insights that ensure resolution of incidents on the first attempt and sometimes even prevent potential future incidents. The platform combines Diebold Nixdorf's decades of unmatched engineering experience, a continuously augmented knowledge base, and the latest developments in IoT, cloud computing and storage, ML, and AI to deliver a solution that helps resolve incidents faster, enables predictive maintenance that prevents failures, and achieves industry-leading first-time fix rates.

### Value Props

- Boost customer satisfaction and loyalty** by supporting higher ATM availability for a better user experience.
- Increase revenue:** a high-performing network attracts more consumers, drives more transactions, and grants branch staff more time to strengthen consumer relationships that drive improved business outcomes.
- Decrease total cost of ownership:** Fewer incidents mean reduced involvement (and related costs) of branch staff and third-party service providers. Better maintenance also helps prolong the lifespan of devices.

### Intel Components

- Intel® Core™ i5 processors
- Intel® Celeron® processors
- Intel® Core™ i3 processors

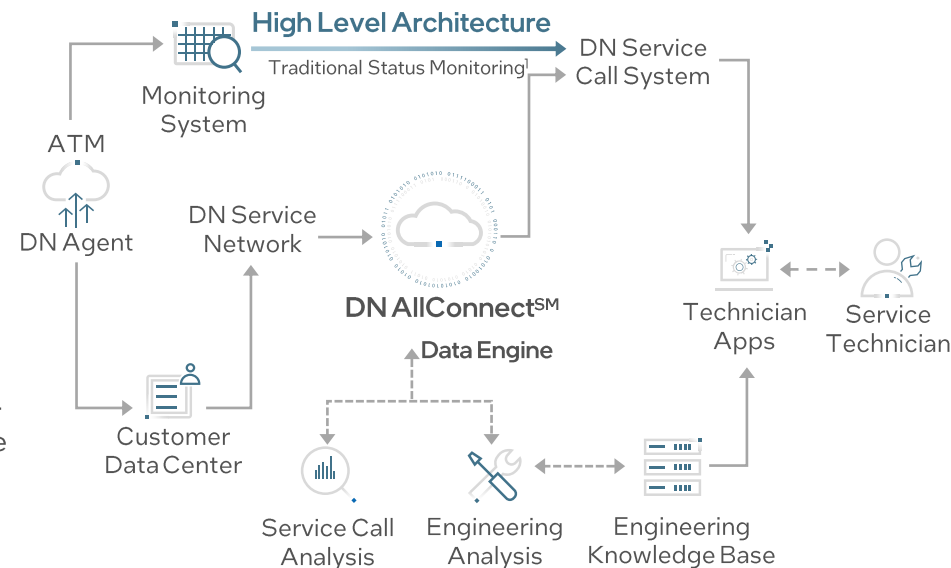

<sup>1</sup>Status Monitoring may be DN, Customer or Third-Party

**Target Vertical:**  
Banking/FSI

**Target Use Case:**  
Asset & Operations Optimization

**Secondary Use Cases:**  
Logistics & Tracking, Machine Condition Monitoring

**Geo Availability**  
Asia, Pacific, Americas, Europe, Middle East, and Africa

### Learn More

- Diebold Nixdorf Software Portfolio
- Diebold Nixdorf Solutions Portfolio
- Solution Video (YouTube)
- Solution Webpage

# Digifort IP Security System Digifort Cloud

## Solution Overview

Designed to meet the growing demand for private, residential, and commercial camera security without taxing local infrastructure, the Digifort IP Security System Digifort Cloud solution creates a centralized data center that allows users to better protect locations and assets.

## Value Props



**Decrease the total cost of security** with an inexpensive security solution that can be integrated with existing cameras, and does not depend on constant maintenance

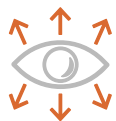

**Increase reliability** with an enterprise security solution that delivers insightful analytics and operates on a proven cloud architecture



**Deploy quickly and effectively** with an intuitive all-in-one solution that is easy to configure and operate

## Kit Components

- Intel® Xeon® Processors
- Intel® Core™ i5 Processors
- Intel® Core™ i7 Processors
- Intel® Core™ i3 Processors
- Intel® NUC
- 10gbe Intel® ethernet network adapters

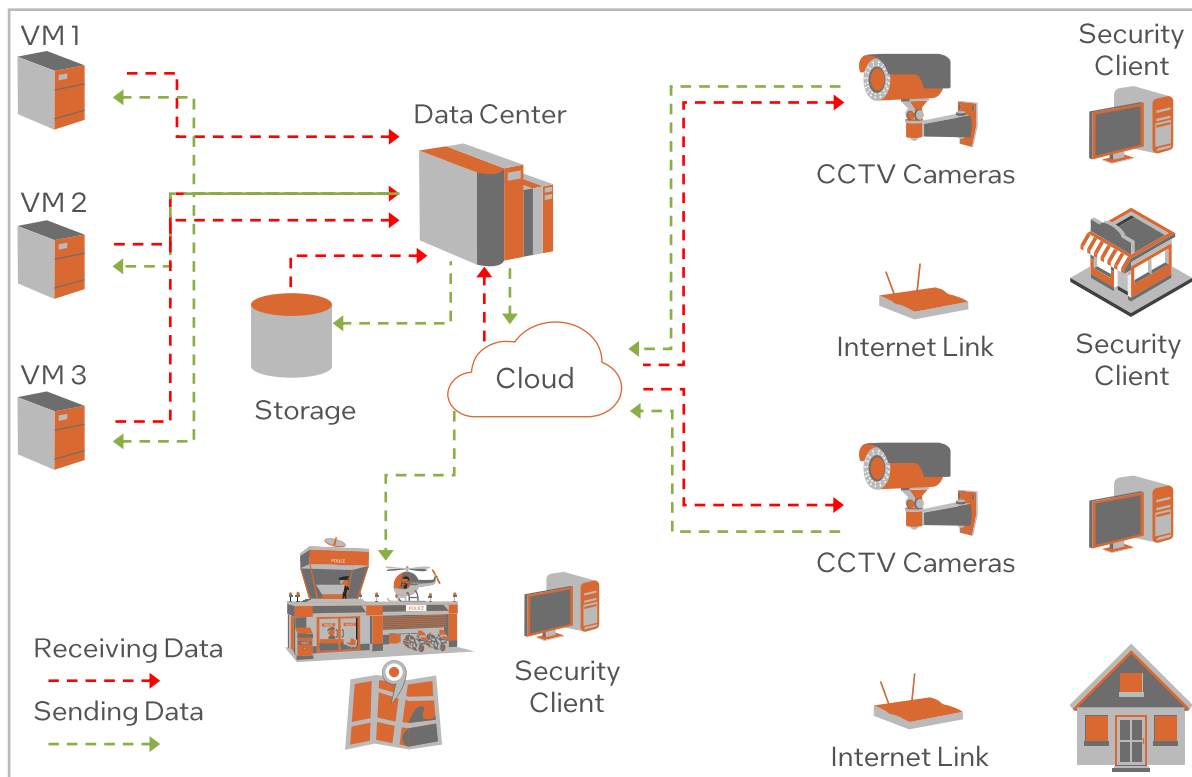

**Target Vertical:**

Retail

**Secondary Vertical:**

Banking/Financial Services, Hospitality, Transportation, Cooperative Neighborhood

**Target Use Case:**

Situational Monitoring

**Geo Availability**

Global

**Learn More**

- [Digifort website](#)
- [Digifort Cloud webpage \(Portuguese\)](#)





# Digital Barriers Heat Detection Camera

## Solution Overview

Powered by Intel® architecture, the Heat Detection Camera Solution utilizes leading-edge thermal imaging technology to help screen individuals for Elevated Body Temperature (EBT), a potential early symptom of a range of contagious illnesses.

## Value Props

-  Reassure employees and customers by taking the appropriate health precautions
-  Provide a highly effective and discrete means of quickly identifying those who show signs of infection
-  Set up quickly and easily in under two hours without needing IT integration

## Intel Components

- Intel® NUC Kit NUC6CAYH
- Intel® Core™ i5-1035G1 Processor
- Intel® Pentium® Processor N4200

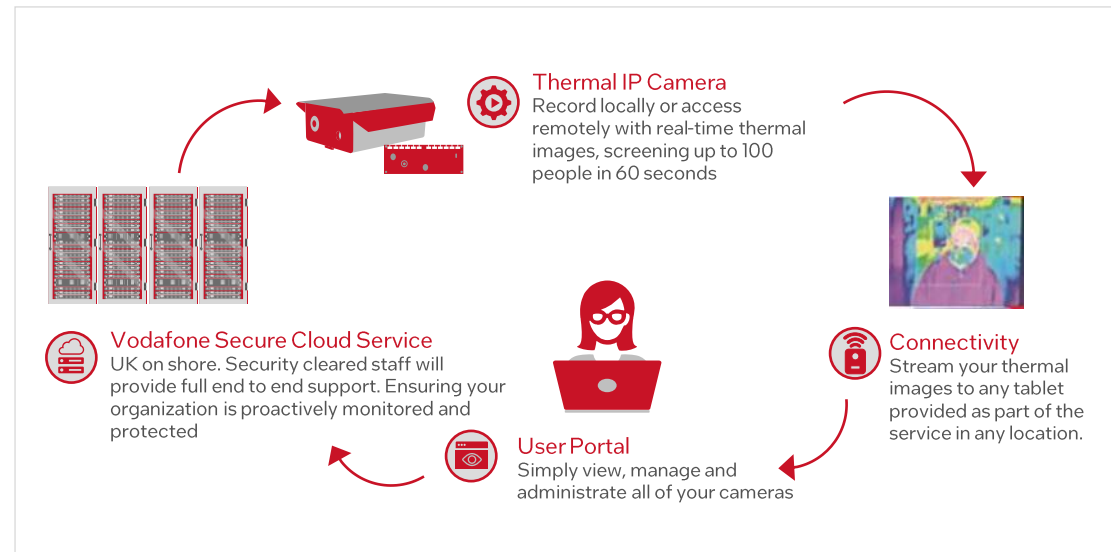

Target Vertical: Health & Life Sciences

Target Use Case: Human Wellness Monitoring

Secondary Use Cases: Situational Monitoring, Interactive Media, Logistics and Tracking

Geo Availability: EMEA

### Learn More

- [Vodafone website](#)
- [Case Study](#)



# Digital China – Warehousing Business Automation and Visualization of Management Process Solution

## Solution Overview

An equipment set designed to meet the needs and pain points of high warehouse labor costs, insufficient infrastructure, and low intelligence. The solution helps businesses manage their warehouses to create higher efficiencies and reduce human error

## Value Props



Enhance warehouse management efficiency with data visualization tools that help supervisors track performance



Improve customer experience by tracking that packages are delivered on time to the correct destination



Decrease costs by driving labor efficiencies and reducing overhead requirements with warehouse automation tools

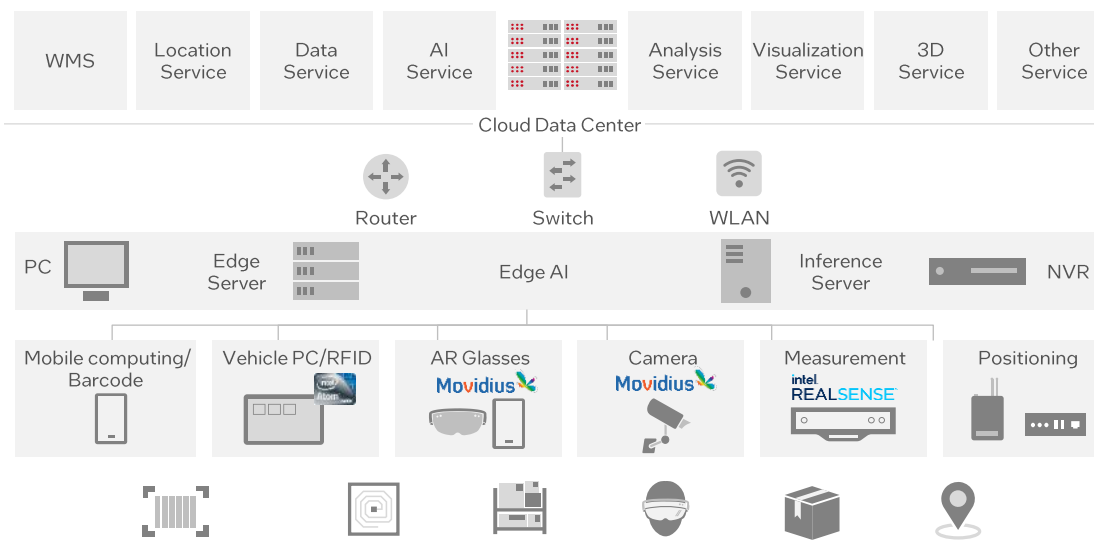

## Intel Components

- Intel® Movidius™ VPUs
- Intel® Atom® Processors
- Intel® Xeon® Processors
- Intel® Core™ i7 Processors
- Intel® OpenVINO™ toolkit
- Intel® Solid State Drives (SSD)
- Intel® Celeron® Processors

Target Vertical:  
Manufacturing

Target Use Case: Logistics and Tracking

Secondary Use Case:  
Product Inspection

Geo Availability  
PRC

Learn More

- Digit China Website

# Digital China iSESOL Intelligent Manufacturing Solution

## Solution Overview

A solution which makes it easier for factories to achieve smart management through the collection of data. By equipping CNC systems with this solution, organizations can increase productivity through intelligent machine diagnosis and clear maintenance decisions.

## Value Props



Simplify manufacturing by optimizing the production schedule and maintenance timeline



Increase accuracy by collecting and uploading manufacturing data



Maintain CNC Systems with proprietary software

## Intel Components

- Intel® Core™ i7 (i7-3555LE)
- Intel Atom® (E3825)
- Intel® SSD (S4500 240G)

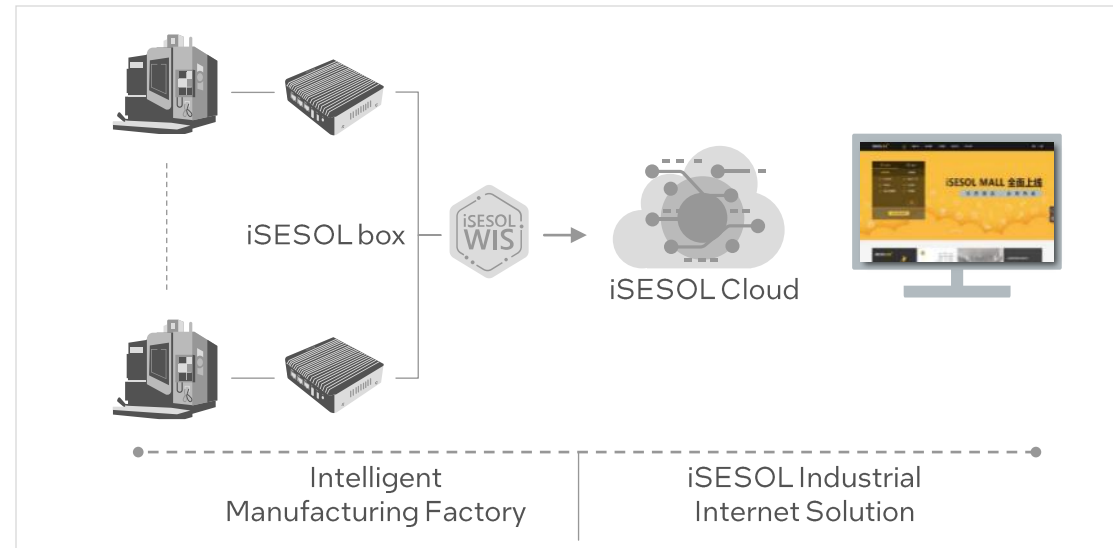

Target Vertical:  
Manufacturing

Target Use Case: Machine  
Condition Monitoring

Geo Availability  
Available in PRC

Learn More

- Digit China Website

# Disrupt-X Cognitive Neurons

## Solution Overview

Disrupt-X's Cognitive Neurons solution with Smart ANPR uses 6 MP cameras along with customized edge servers to report to Disrupt-X IoT Platform where the vehicle number plate is processed to verify if this vehicle is authorized or not. The solution also utilizes Intel® Distribution of OpenVINO™ toolkit for the AI/ML processing. The solution addresses the challenges faced by residential and commercial parking spaces and eliminates the need of physical access cards. The IoT platform provides property owners beneficial analysis on parking utilization and logs on all entries into their properties, revenue analysis on commercial properties along with ability to view reports and customized dashboards. Disrupt-X also provides mobile application for the residents/tenants in residential properties to view their parking logs and register their vehicles conveniently. This cloud-based IoT solution can significantly improve customer experience, provide beneficial analytics to property owners and reduce operational costs.

**Target Vertical:**  
Transportation

**Secondary Vertical:**  
Government, Hospitality, and Retail

**Target Use Case:**  
Asset & Operations Optimization

**Geo Availability**  
Asia, Pacific, and Japan, Americas, Europe, Middle East, and Africa, People's Republic of China

### Learn More

- [disrupt-X Home Page](#)
- [Smart ANPR IoT](#)

## Value Props



**Simplify parking management** by automatically recognizing, analyzing and storing license plate data, minimizing the need for human management



**Provides a better experience for tenants** by shortening lines and wait times, expediting payment, and making available spaces easier to find



**Improves cost efficiency** with 24/7 remote management for asset owners by removing dependency on access cards and security personnel for managing accesses into properties



## Intel Components

- Intel® Core™ i3 processors
- Intel® Core™ i5 processors
- Intel® Core™ i7 processors
- Intel® Distribution of OpenVINO™ toolkit



# Disrupt-X Ignite Shield

Back to Government Solutions

Back to Environmental Monitoring Solutions



## Solution Overview

The Disrupt-X Ignite Shield is a full-stack IoT solution for monitoring air, gas, and water quality through a cloud platform and mobile application. The platform helps protect the integrity of customer assets by monitoring specific quality control specifications and escalating alarms when assets enter vulnerable operational states. To keep data protected from sensor to cloud, decryption keys are installed, while also using the latest security features from providers like Cloudflare and AWS.

## Value Props



**Simplify asset management** by utilizing the solution's integrated alarm escalations system to inform users when assets are at risk of entering hazardous operational situations



**Extend asset lifetime** using an integrated cloud platform and mobile application to enable predictive maintenance and streamline corrective actions



**Reduce facility management costs** with 24/7 remote management to respond to asset issues in real-time, thereby reducing the manual labor requirements associated with routine manual monitoring, metering, and measuring

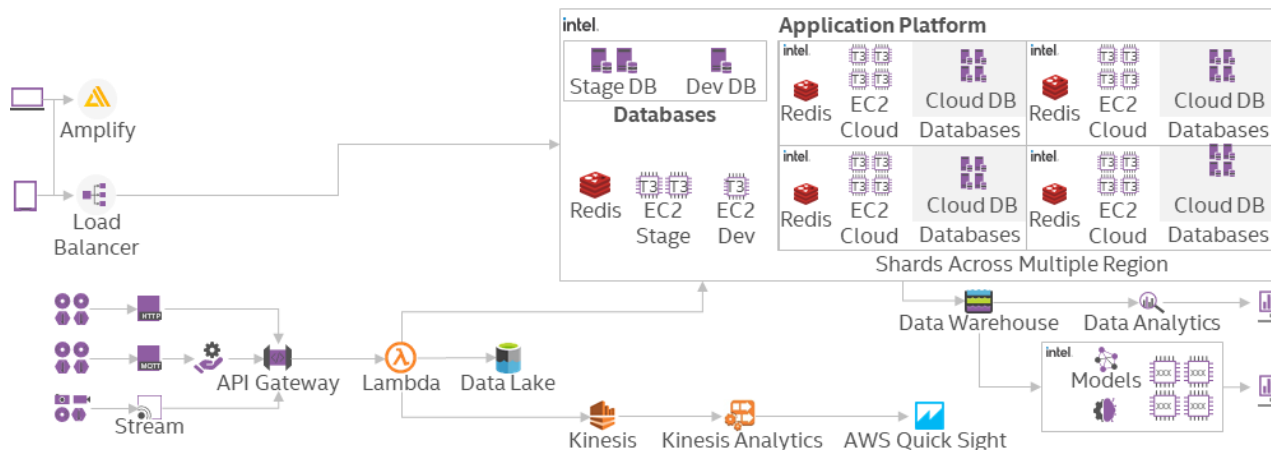

## Intel Components

- Intel® Xeon® Scalable Processors

**Target Vertical:**  
Government

**Secondary Vertical:**  
Agriculture, Education, Energy, Health and Life Sciences, Hospitality, Retail, Manufacturing, Transportation, Warehousing

**Target Use Case:**  
Environmental Monitoring

**Geo Availability:**  
Global

## Learn More

- Disrupt-X IoT Platform Webpage
- Ignite Shield Features Webpage



# DOTS Smart Energy Services

## Solution Overview

This solution helps organizations reduce their electricity consumption by upgrading systems and optimizing building operations. SES works by tracking a building's energy consumption in real-time and conveniently providing users with this information to eliminate energy waste, optimize resources, and improve overall efficiency.

## Value Props



**Reduce energy consumption costs** by tracking where energy usage can be reduced without impacting efficiency.



**Drive actionable energy usage insights** through detailed energy analysis based on real-time monitoring



**Improve and enhance corporate reputation** by mitigating climate change for greener corporate practices.

## Intel Components

- Intel® Atom® Processors
- Intel® Solid State Drives (SSD)
- Intel® Core™ i7 Processors
- Intel® Xeon® Processors

Target Vertical: Energy

Target Use Case: Other, Government

Secondary Use Cases: Education, Smart Cities

Geo Availability: Globally

Learn More  
[DOTS Energy Industry page](#)

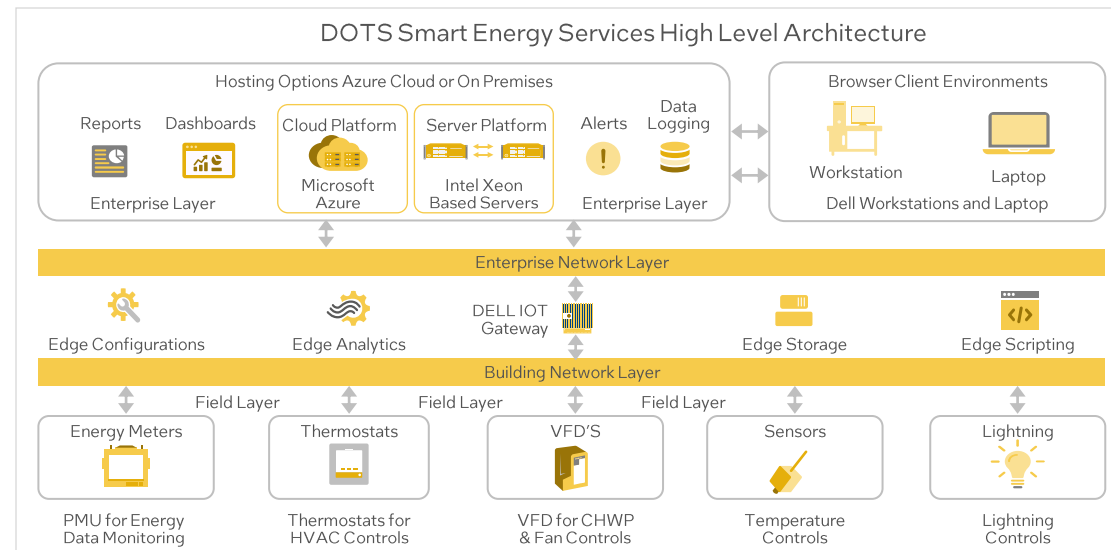

# Dot Zero Connect ZPS

## Solution Overview

Dot Zero's Connect TPS is a leading smart factory solution that addresses customer needs through the application of IoT technology and data analytics. The solution connects traditional and computer numerical control (CNC) equipment across factory environments to collect operational data in real-time. Relevant stakeholders gain insights related to equipment and personnel efficiency, overall equipment effectiveness (OEE), and have the capability to monitor and manage factory operations remotely.

## Value Props

Improve the transparency of enterprise management and greatly reduce factory management costs by integrating production information with ERP (Enterprise Resource Planning), WMS (Warehouse Management System), quality and financial analysis software

Maintain stable product yields by providing product history traceability, analyze abnormal equipment issues and trends

## Intel Components

- Intel® Core™ i5 processors
- Intel® Celeron® processors
- Intel® Distribution of OpenVINO™ toolkit
- Intel® TEP

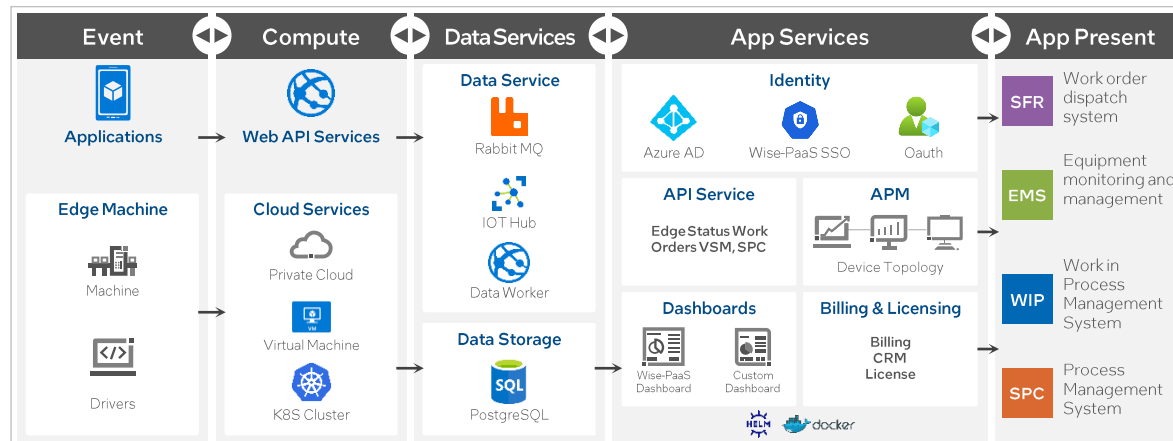

Target Vertical:  
Manufacturing

Secondary Vertical:  
Transportation

Target Use Case:  
Asset & Operations Optimization

Secondary Vertical:  
Machine Condition Monitoring, Product Inspection, Situational Monitoring

Geo Availability  
APJ and Americas

## Learn More

- [Dot Zero – Home page](#)
- [Microsoft Azure Marketplace](#)

# Ectron Corporation SmartEYE™ Intelligent Edge Node

## Solution Overview

SmartEYE™ helps its customers track each step of the production line with a 360-degree view of operations including machines, personnel, processes and energy usage. With over 1,800 industrial-grade sensor options, the solution can be tailored for countless applications. Moreover, there are ready-made kits for quick deployment for injection molding machines, computer numerical control (CNC) machines, industrial ovens, dry boxes, large agri-drying beds and packing stations. In fact, the solutions ruggedization and flexibility makes it useful in a variety of verticals including manufacturing, food processing, pharmaceuticals, oil & gas and smart cities. SmartEYE™ delivers its customers comprehensive analytics reports to ensure product quality, consistency, and efficiency.

## Value Props



**Improve product quality** by monitoring and optimizing traffic flow, equipment performance, personnel, processes 24/7 and in real-time



**Increase production output** by assessing precise manufacturing conditions, the exact cost of creating each widget, and the optimal adjustments necessary to improve the yield during the manufacturing process



**Mitigate extra expenses** utilizing data insights to improve the efficiency of job scheduling and warehouse energy utilization

## Intel Components

- Intel® Core™ i3 processors
- Intel® Xeon® processors

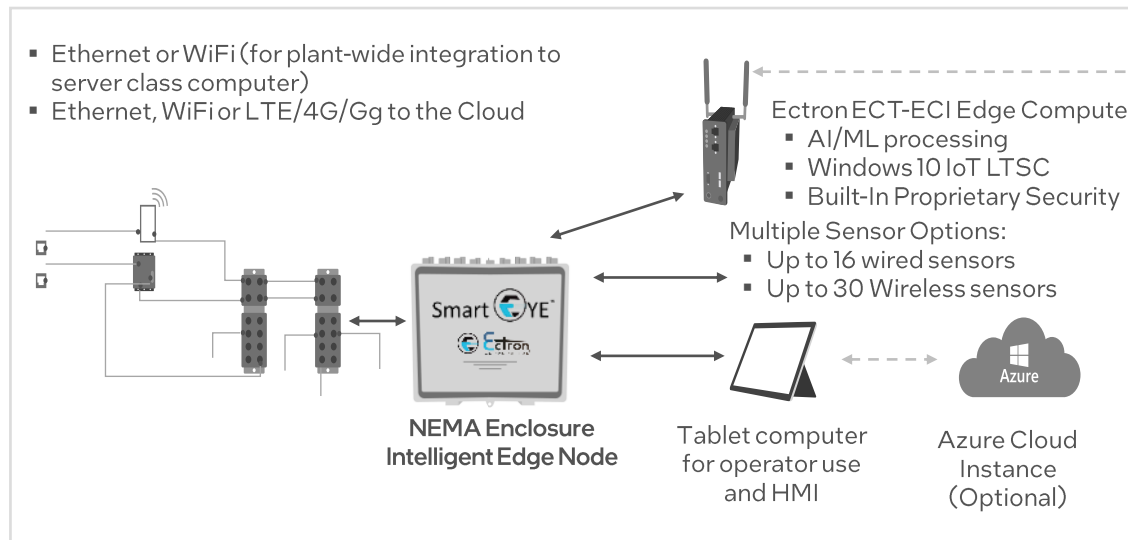

**Target Vertical:**  
Manufacturing

**Secondary Verticals:**  
[Agriculture](#), [Energy](#), [Government](#), [Transportation](#) and [Warehousing](#)

**Target Use Case:**  
[Asset & Operations Optimization](#)

**Secondary Use Cases:**  
[Energy Monitoring & Management](#), [Machine Condition Monitoring](#), [Product Inspection](#), [Situational Monitoring](#)

**Geo Availability**  
APJ, EMEA, Americas

### Learn More

- [SMARTEYE Solution Home Page](#)
- [Product Video Overview](#)
- [Injection Molding Use Case](#)



## Solution Overview

Industrial manufacturing is a complicated process that involves heavy operational workloads in dynamic environments, and companies struggle to maintain efficiency and optimize operations on the factory floor. Eigen Machine Vision is a suite of services and tools developed to help discrete and continuous manufacturers unlock the value of image data to better manage product and process variability across their machines, lines, and factories. As a complete solution, it gives manufacturers, integrators and automation solution providers a scalable product and process intelligence platform and if deployed separately, the tools and services can upgrade existing machine vision systems. The solution can be used to help mitigate the risk of defects, reduce waste and equipment downtime, and realize hundreds of thousands of dollars in savings per line annually.

## Value Props

-  **Optimize manufacturing operations** with quality and process insights that reduce unplanned downtime, improves quality assurance, and increases OEE
-  **Improve visibility** across factory processes with digital records and real-time analytics communicated through dashboards that provide operational insights
-  **Reduce operational costs** by mitigating equipment downtime, massively reducing facility waste, and minimizing the potential for line defects

## Kit Components

- Intel® Core™ Processors
- Intel® Distribution of OpenVINO™ toolkit

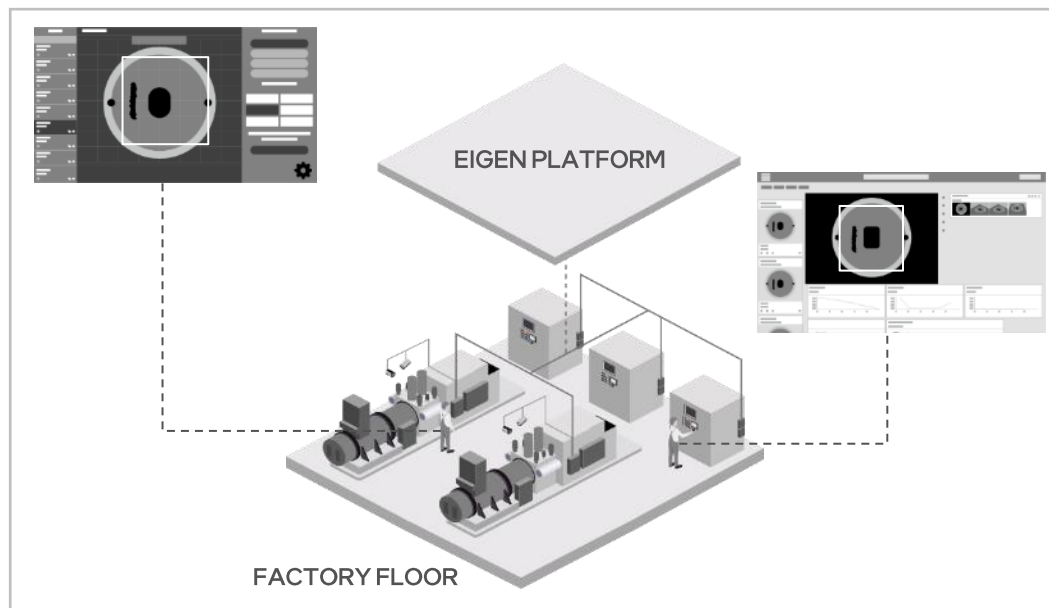

**Target Vertical:**  
[Manufacturing](#)

**Secondary Vertical:**  
[Health & Life Sciences](#)

-----  
**Target Use Case:**  
[Asset & Operations Optimization](#)

**Secondary Use Cases:**  
[Control Optimization & Autonomy, Quality & Process Monitoring](#)

-----  
**Geo Availability**  
APJ, Americas, Europe, Middle East, and Africa

## Learn More

- [Eigen Innovations Website](#)



# Elenium HealthGate Touchless Control and Vital Sign Detection

## Solution Overview

Elenium HealthGate is a touchless control and vital sign detection solution designed to bring wellness technology to high-traffic areas. By removing potential vectors for viral or bacterial transmission, facilities can manage access while helping to create safer customer engagements.

## Value Props

- Promote peace of mind for users through touchless vital sign screening and contactless functionality
- Increase processing efficiency through intuitive user-friendly controls, freeing operational staff to focus on other areas
- Integrate seamlessly into existing facilities and processes, using optimized Elenium technology powered by Intel processors

## Intel Components

- Intel® NUC
- Intel® RealSense™ Technologies

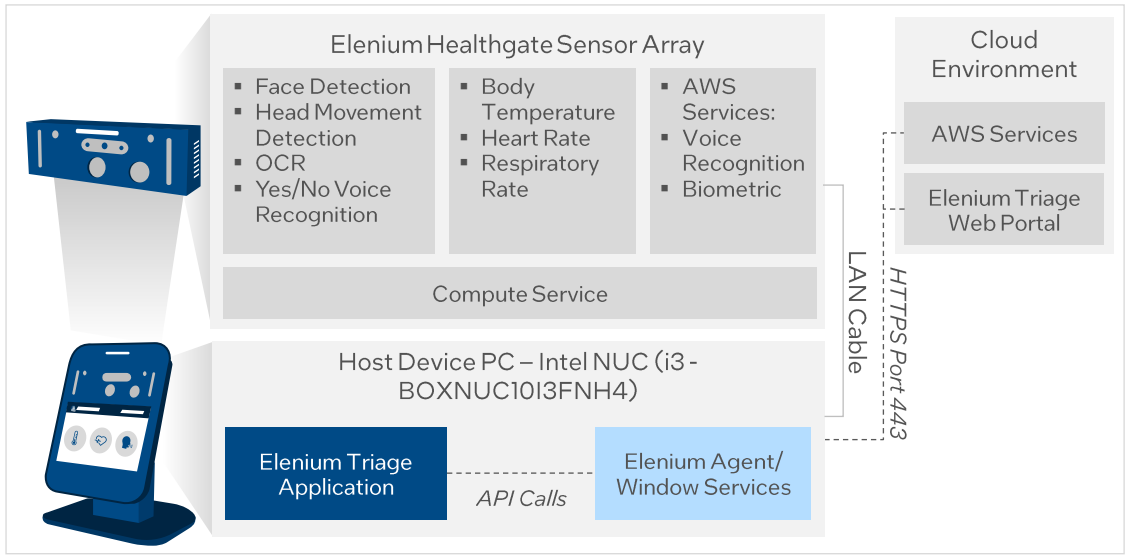

**Target Vertical:** Hospitality  
**Secondary Vertical:** Health & Life Sciences, Airlines, Transportation Hubs

**Target Use Case:** Human Wellness Monitoring  
**Secondary Use Case:** Other

## Learn More

- [Elenium website and solution information](#)
- [Additional case studies and solution demo videos](#)

# Exosite ExoSense Condition Monitoring Solution

## Solution Overview

The ExoSense Condition Monitoring System is a ready-to-deploy application that provides transformative visibility into industrial assets, systems, and equipment. By tracking crucial data such as equipment runtime, usage, and energy consumption, ExoSense allows customers to optimize their factory environments and monitor equipment with ease to maximize the value of their machine data and improve efficiency.

## Value Props

- Increase onsite efficiency** by collecting historic and real-time machine data to deliver actionable insights that can minimize downtime, enhance product quality, and optimize factory throughput.
- Reduce maintenance and operational costs** with a solution that monitors equipment in real-time while tracking historical data trends to identify when maintenance is required and provide insights into usage
- Improve management** with a solution that tracks equipment and floor on-goings across multiple locations and presents data in a centralized platform to improve day-to-day and long-term decision making.

## Intel Components

- Intel® Xeon® SP Gold processors
- Intel® Xeon® SP Platinum processors

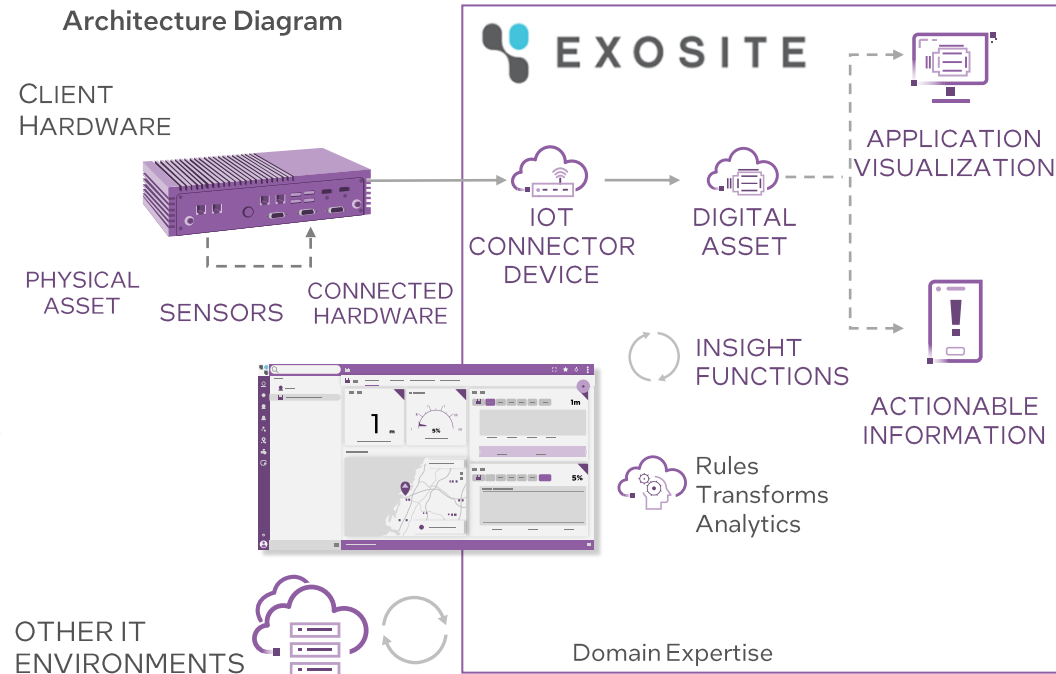

**Target Vertical:**  
Transportation & Warehousing

**Secondary Vertical:**  
Agriculture, Energy, Manufacturing

**Target Use Case:**  
Asset & Operations Optimization

**Secondary Use Cases:**  
Control Optimizations & Autonomy, Environment Monitoring, Machine Condition Monitoring, Situational Monitoring

**Geo Availability**  
Asia, Pacific, and Japan, Americas, Europe, Middle East, and Africa, People's Republic of China

**Learn More**

- [Exosite Website](#)
- [Exosite ExoSense Webpage](#)



[Back to Retail Solutions](#)

[Back to Situational Monitoring Use Cases](#)



# Expertos En Sistemas Braingine Machine Vision

## Solution Overview

Braingine leverages Intel® NUC high-powered edge compute technology for automated inspection of planogram compliance, customer traffic flow, and infinite number of business performance queries for analytics based on AI reporting and recommendations.

## Value Props



Gain incremental sales by in-depth monitoring of display and shelving



Optimize operational performance with AI edge compute



Execute real-time AI-generated strategies via high performance machine vision

## Intel Components

- Intel® NUC
- Intel® Xeon® Processors
- Intel® Solid State Drives (SSD)
- Intel® Neural Compute Stick 2
- Intel® Movidius™ Myriad™ X VPU

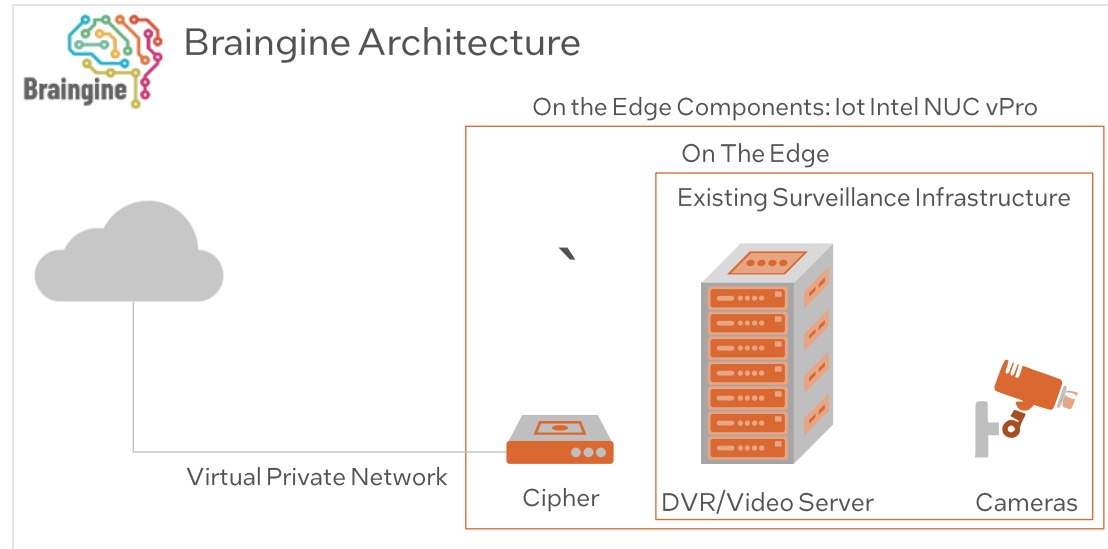

**Target Vertical:** Retail

Secondary Verticals: Banking/Financial Services, Hospitality, Manufacturing, Government, Transportation

**Target Use Case:** Situational Monitoring

Secondary Use Case: Logistics & Tracking, Environmental Monitoring

**Geo Availability**  
Americas

## Learn More

- Learn more about Innodap solutions on the [Expertos website](#)
- Learn more about the Braingine solution [here](#)
- Contact [Expertos here](#) for access to their CMS



# Exterity Digital Signage and IP Video Solution

## Solution Overview

The Exterity Digital Signage and IP Video Solution enables organizations to communicate more effectively with their customers and staff through the integration of video, audio, and graphics. The end-to-end solution distributes media from a variety of feeds to multiple devices over IP networks.

## Value Props



**Engage customers quickly** with eye-catching digital signage that combines dynamic graphics, text, and video elements to inform, promote, or entertain



**Scale brand assets** with an enterprise-ready solution that helps manage and configure digital signage with ease



**Drive ROI growth** with digital signage powered by IPTV technology that helps inform and promote products and services

## Intel Components

- Intel® Atom® Processors
- Intel® Xeon® Processors
- Intel® Core™ i3 Processors
- Intel® Media SDK

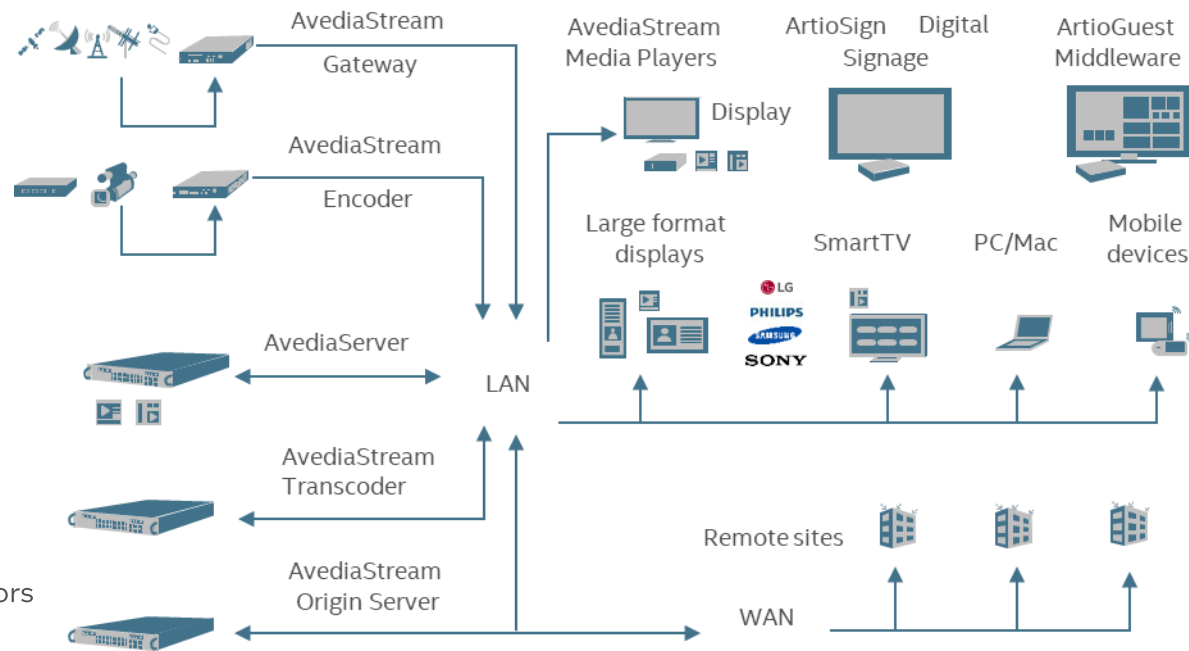

**Target Vertical:**  
Banking/FSI

**Secondary Vertical:**  
Hospitality, Health & Life Sciences, Manufacturing, Transportation, Energy, Education, Venues

**Target Use Case:**  
Interactive Media

**Secondary Use Case:**  
Organisation-wide TV/Video Distribution, Digital Signage

**Geo Availability**  
United States, Europe, Middle East, Africa, and APAC

### Learn More

- [Exterity website](#)
- [Exterity – IPTV & Digital Signage Solutions with executive interviews](#)
- [Bayer UK Case Study](#)



# Calmo IOT Terminal for Manufacturing and POS

## Solution Overview

With Calmo IOT Terminal, users can input manufacturing data, see manufacturing data from multiple sources, and engage employees on the job with training, time tracking, and instructions. Traditionally, PC functionality had been a challenge at production sites—welding sparks flying, liquids spraying, and the necessity of protective gloves for employees meant that touch screens were out of the question and traditional computer set ups needed to be out of site. With Calm IOT Terminal, PC display and data entry is possible in almost any factory setting.

## Value Props

**Implement a durable solution** with industrial protection against dust, liquid, aggressive cleanser and temperature changes

**Improve operational efficiency and decision making** by providing comprehensive views of operations sourced inputs across the floor

**Empower employees** by facilitating on-the-job training and instruction for maximum effectiveness

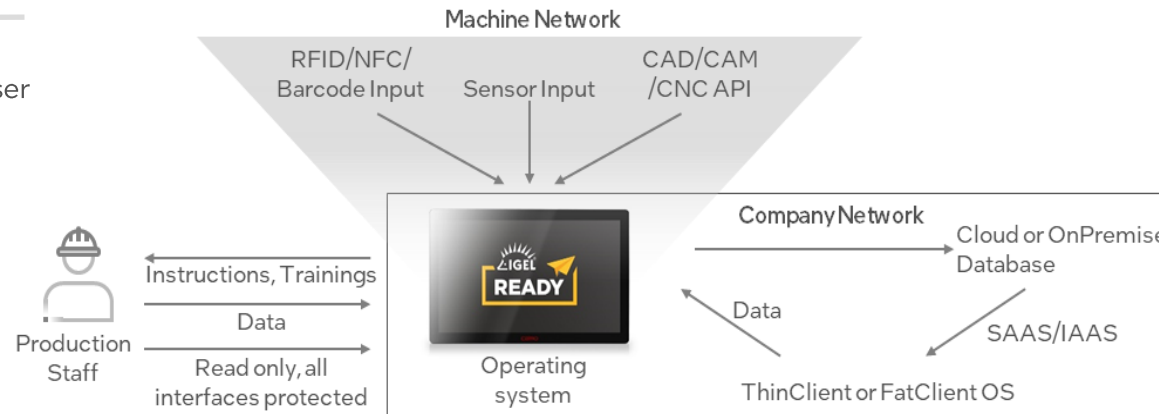

**Target Vertical:**  
Manufacturing

**Secondary Vertical:**  
Energy, Retail, Digital Signage, Transportation, Warehousing

**Target Use Case:**  
Asset & Operations Optimization

**Geo Availability**  
EMEA, Americas, APJ

## Learn More

- [Calmo IOT Terminal Home Page](#)
- [EXTRA Computer GmbH](#)

## Intel Components

- Intel® Celeron® Processors
- Intel® Core™ Processors
- Intel® Pentium® Silver J5005 Processor
- Intel® Ethernet Controller i210
- Intel® Wireless AX200

# faytech AG EASY Shopper

## Solution Overview

The faytech AG EASY Shopper solution assists customers in finding products using a cart-mounted GPS and touchscreen. It also shows discounted products and the most efficient path through the store according to the customer's shopping list. Retailers can also check customer behavior and obtain analytics to offer targeted promotions.

## Value Props

**Reduce costs** with fewer cashiers and more cashless payments

**Increase customer throughput** with innovative way finding technology to accelerate customer traffic through the store

**Improve marketing messaging** by using customer data and behavior to offer personalized promotions

## Intel Components

- Intel® Celeron® Processors
- Intel® Core™ i3 Processors

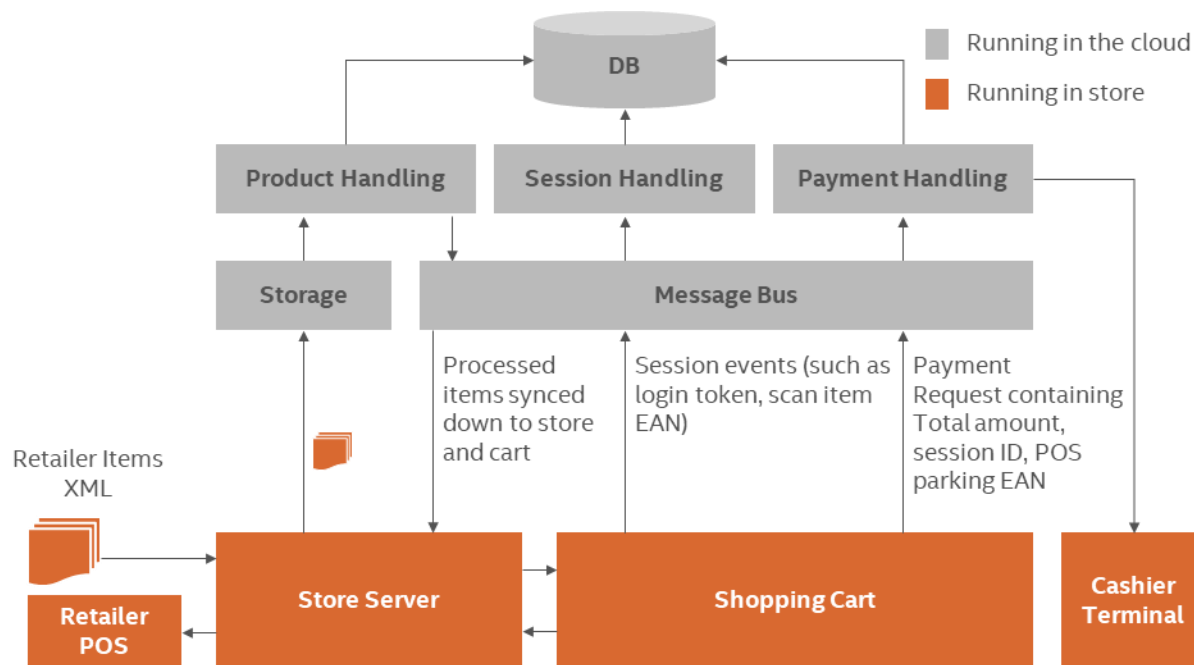

**Target Vertical:**  
Retail

**Target Use Case:**  
Logistics & Tracking

**Secondary Use Case:**  
Interactive Media, Product Inspection

**Geo Availability**  
NA, EMEA, PRC, Japan, India

### Learn More

- [faytech AG Website](#)
- [faytech AG Product Page](#)
- [EASY Shopper Website](#)
- [Intel Solutions Marketplace](#)



### Solution Overview

A solution that enables retailers to create frictionless customer journeys regardless of where a consumer decides to begin their shopping experience—whether it is online, in a store, or on a mobile app

### Value Props



Capture more sales by offering customers a seamless shopping experience



Empower employees with the tools they need to do their job



Realize upsell opportunities by engaging shoppers with personalized offers

### Intel Components

- Intel® Core™ i3
- Intel® Core™ i5
- Intel® Xeon®

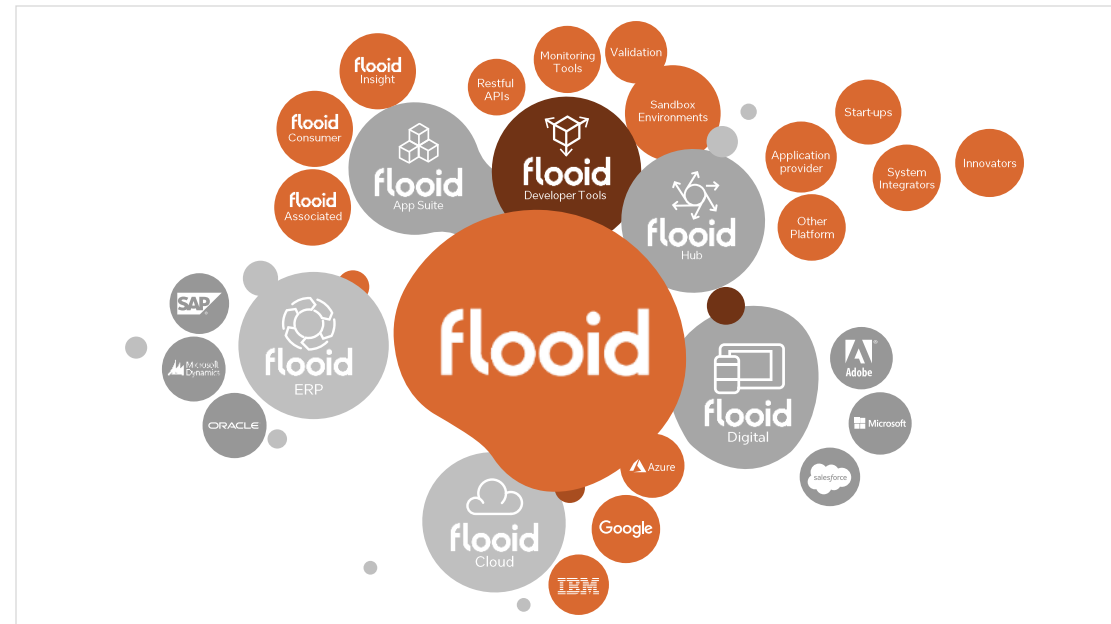

Target Vertical: Retail

Secondary Verticals: Hospitality

Target Use Case: Interactive Media

Secondary Use Case: Logistics & Tracking

Geo Availability

EMEA, North America, APJ, PRC

Learn More

- [Floodid website](#)
- [Floodid YouTube Channel](#)



# Fortinet Secure Branch

## Solution Overview

The Fortinet Secure Branch solution enables customers to converge their security, WAN, and LAN infrastructure components into a single platform solution. NGFW, SD-WAN and ZTNA features integrate with the FortiGate firewall to allow for secure onboarding of IoT devices while managing real-time security of all devices on the network. Once the devices are authenticated on the network, any vulnerabilities or security anomalies that are detected are automatically isolated to minimize burdens on staff and decrease response time.

## Value Props



Protect any edge and any app at scale† with advanced threat protection, convergence of network and security, SSL-Decryption and network automation



Simplify access layer security with direct and integrated control and configuration, and management which extends NGFW to LAN Edge



Reduce costs and complexity with a secure, business outcome driven WAN with better application performance and integrated security



Control every device on every network by automatically discovering devices and applying policy at scale

**WAN Edge**  
NGFW  
SD-WAN  
Routing

**LAN Edge**  
ZTNA  
NAC

**Device Edge**  
FortiClient  
EDR

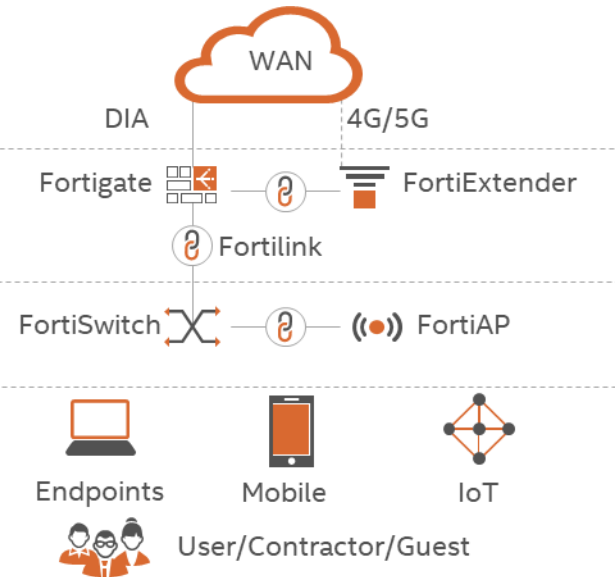

## Intel Components

- Intel® Core™ i5 Processors
- Intel® Xeon® E Processors
- Intel® QAT
- Intel® Core™ i7 Processors
- Intel® Xeon® E5 Processors
- Intel® SDO
- Intel® Xeon® D Processors
- Intel® Atom® Processors

**Target Vertical:**

[Retail](#)

**Secondary Verticals:**

[Hospitality](#)

**Target Use Case:**

[Asset & Operations Optimization](#)

**Secondary Use Cases:**

[Situational Monitoring](#), [Digital Transformation](#), [Network & Security Convergence](#)

**Geo Availability**

Globally Available

**Learn More**

- Fortinet website
- Fortinet retail
- Fortinet Fabric



# ForwardX Robotics Visual Autonomous Mobile Robots

## Solution Overview

ForwardX provides robotics and software solutions that enable logistics & manufacturing operations to automate material handling processes and manage the fleet of AMRs from a central system. ForwardX robots leverage computer vision and lidar to understand changing environments and allow leaders to maximize performance.

## Value Props



**Improve productivity and efficiency** with AMRs that transport materials to help minimize walking time and improve throughput



**Optimize operations** by managing of up to 200 AMRs through ForwardX's Matrix fleet management software



**Scale rapidly** with a straightforward implementation, and no new infrastructure or layout adjustments

## Intel Components

- Intel® Core™ i5 Processors



**Target Vertical:**  
[Manufacturing](#)

**Secondary Vertical:**  
[Hospitality](#), [Retail](#)

**Target Use Case:**  
[Control Optimization & Autonomy](#)

**Secondary Use Case:**  
[Asset & Operations Optimization](#), [Logistics & Tracking](#)

**Geo Availability**  
Asia-Pacific, North America, South America, Europe

**Learn More**  
[ForwardX Website](#)

# GDDi Algorithms Defined Edge AIBox Based on Intel® Series Chips

## Solution Overview

The GDDi Algorithms Defined Edge AIBox harnesses the power of the Intel® AI Box to deliver an automated AI training platform that allows users to obtain and deploy customized AI models with ease. The GDDi Algorithms Defined Edge AIBox simplifies algorithm training with a no-code approach and provides customers with deeper insights into their data to help improve the accuracy of AI algorithms.

## Value Props



**Maximize value** of captured data with a solution that offers easily deployable no-code machine learning algorithms that automatically analyze data to deliver actionable insights



**Increase efficiency** of algorithm production with a solution that enables faster production and allows independent algorithm production for any customer who needs it



**Reduce costs** through automated algorithm capacity that helps enterprises achieve higher returns with lower investment to decrease the cost and cycle of AI applications while increasing input and output

## Intel Components

- Intel® Distribution of OpenVINO™ toolkit
- Intel® Celeron® processors
- Intel® Core® processors
- Intel® AI Box

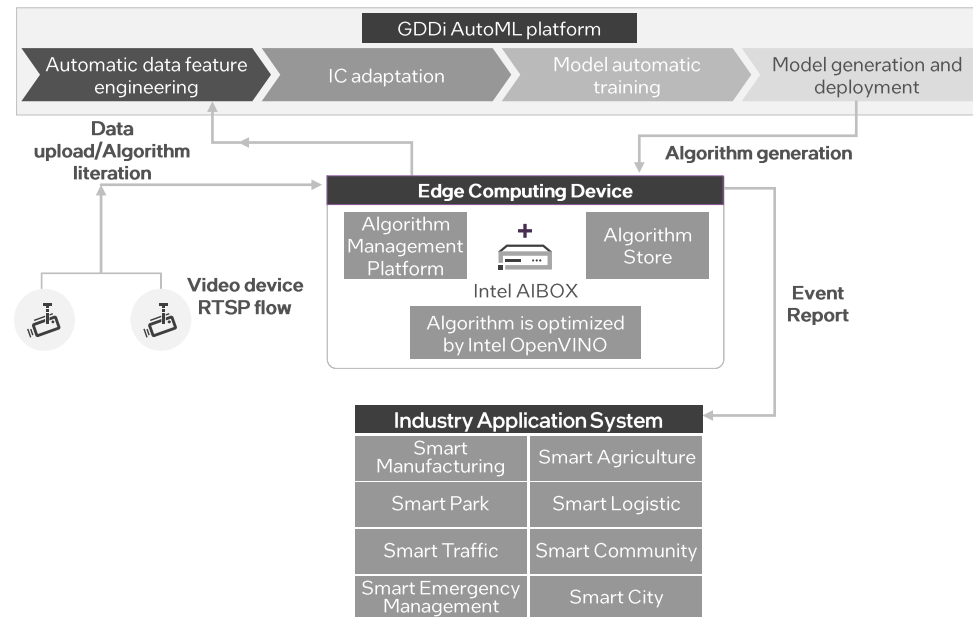

## Target Vertical:

Other

## Secondary Verticals:

Government, Energy, Agriculture, Banking/Financial Services, Energy, Hospitality and Restaurants, Manufacturing, Retail, Transportation

## Target Use Cases:

Asset & Operations Optimization, Control Optimization & Autonomy, Energy Monitoring & Management, Logistics & Tracking

**Secondary Use Cases:** Safety Production Supervision, Agricultural Production, Scientific Education, Environmental Protection

## Geo Availability:

People's Republic of China

## Learn More

- GDDi Website



# Geek+ AI AMR Edge Cloud Smart Logistics Solution

## Solution Overview

The Geek+ AI AMR Edge Cloud Smart Logistics Solution is a multi-form factor robotics system that enables manufacturers and logisticians with a fully automated inventory management system. This AMR (Autonomous Mobile Robot) solutions is capable of independently transporting a wide range of industrial products, including pallets, and coordinating with live personnel. The Smart Logistics Solution provides diverse capabilities applicable to a wide range of complex product management needs.

## Value Props

- Optimize internal logistics** through solution providing precise inventory analysis and interfaces with staff
- Enable efficient procurement management** through an AMR solution that automates transportation for material requisition and avoids collisions
- Increase staff productivity** by automating routine processes, eliminating potential human error, and allowing staff to focus on higher-level tasks

Geek+ WMS system service module

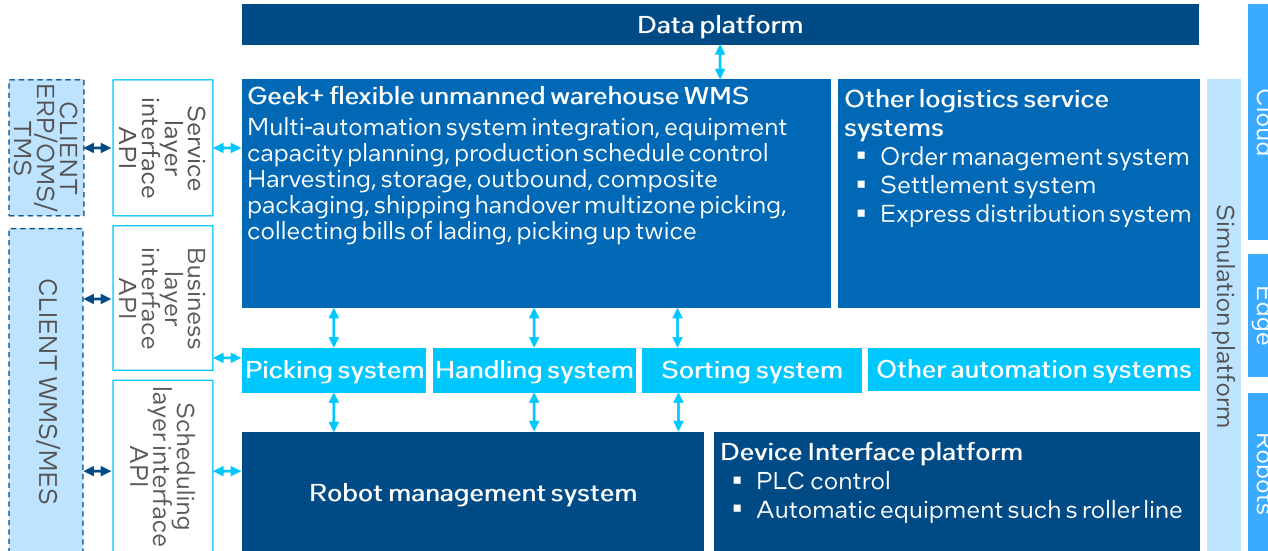

## Intel Components

- Intel Components
  - Intel® Core™ i3 Processors
  - Intel® Xeon® Processors
  - Intel® RealSense™ Technologies

**Target Vertical:**  
Manufacturing

**Secondary Verticals:**  
Health & Life Sciences, Hospitality, Retail, Transportation

**Target Use Case:**  
Control Optimization & Autonomy

**Geo Availability**  
Peoples Republic of China

**Learn More**

- [Solution architecture](#)
- [Solution documentation](#)
- [Geek+ URL](#)

# GE Healthcare Edison

## Solution Overview

GE Healthcare Edison empowers healthcare providers with a vast quantity of information generated in each patient visit and converts it into actionable insights using the latest analytics, deep learning, and AI technologies. With Edison, Healthcare providers get applications embedded in smart devices or edge hardware, a digital framework, and a connected ecosystem where AI can drive better healthcare outcomes.

## Value Props

- Achieve greater efficiency** by prioritizing workflows and reducing redundancies
- Improve patient outcomes** through more personalized care made possible by greater intelligence
- Increase access to care** by improving throughput and decreasing wait times

## Intel Components

- Intel® Xeon® Processors
- Intel® Solid State Drives (SSD)
- Intel® Distribution of OpenVINO™ toolkit
- 10gbe Intel® ethernet network adapters

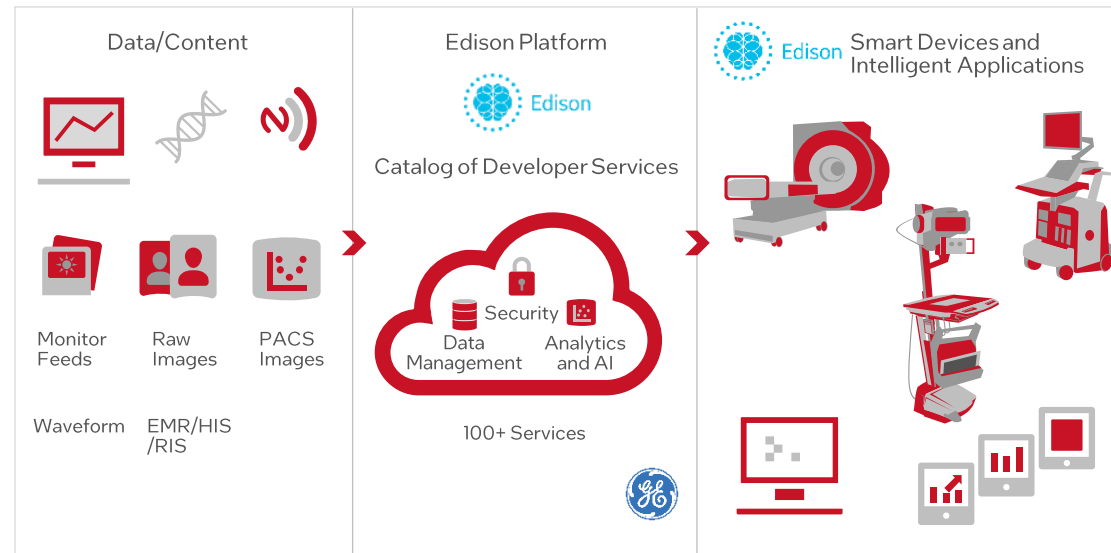

**Target Vertical:** Health and Life Sciences

**Target Use Case:** Human Wellness Monitoring

**Secondary Use Case:** Asset & Operations Optimization

**Geo Availability**  
Globally

### Learn More

- [Infographic](#)
- [Product Page](#)
- [Applications](#)



# GeoVision Smart End-to-End Video

## Solution Overview

A versatile and effective IP-based DSS system that brings video surveillance to the IoT ecosystem by connecting different IoT platforms and existing hardware to create an all-in-one physical security solution

## Value Props



Increase operational efficiency with centralized video management and A.I.-infused video analytics



Reduce deployment costs with a scalable solution that can be quickly implemented



Protect people and assets with 24/7 video surveillance and controlled access

## Intel Components

### GV-VMS

- Intel® Core® i5 processor /i7
- Intel® SSD
- Intel® Media SDK
- Intel® HD Graphics
- Intel® System Studio
- Intel® Computer Vision SDK

### GV-Recording Server

- Intel® Core® i5/i7
- Intel® SSD
- Intel® Media SDK
- Intel® HD Graphics

### Datacenter/cloud server

- Intel® Core® i5/i7
- Intel® SSD
- Intel® Media SDK
- Intel® HD Graphics
- Intel® System Studio
- Intel® Computer Vision SDK

### GV-Control Center

- Intel® Core® i5/i7
- Intel® SSD
- Intel® Media SDK
- Intel® HD Graphics

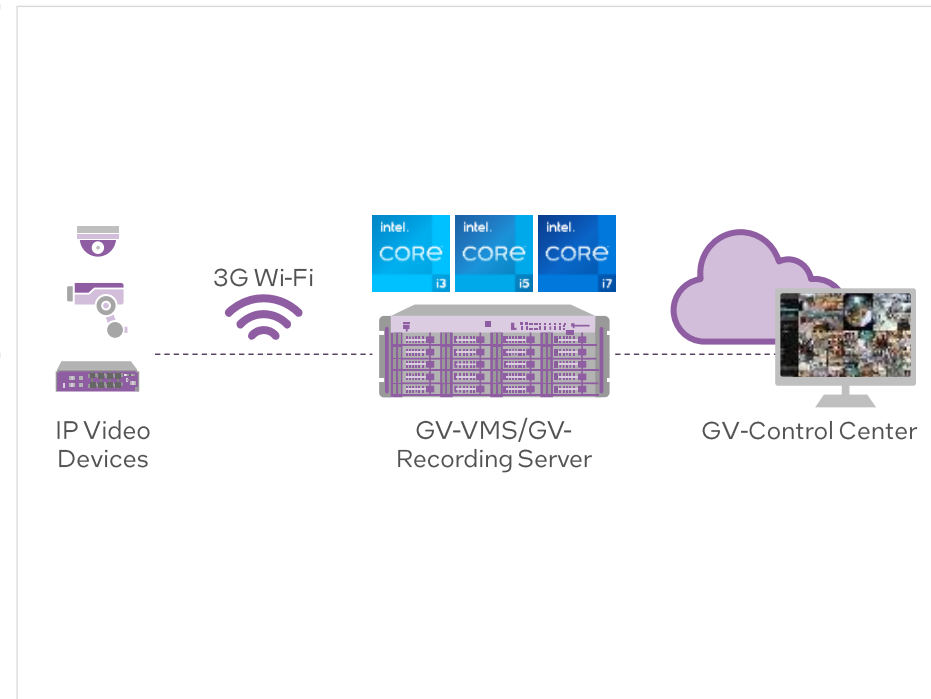

Target Vertical:  
Government

Secondary Verticals:  
Retail, Banking/Financial Services, Hospitality, Education, Health & Life Sciences

Target Use Case:  
Situational Monitoring

Geo Availability  
AMER, EMEA, Asia, Japan, and China

## Learn More

- [GeoVisionWebsite](#)
- [GV-VMS webpage](#)

# Getac Video Solutions

## Solution Overview

In-car and body-worn video surveillance devices for the Public Safety sector that enable outstanding video quality, user-friendly management, and robust data analytics

## Value Props

- Improve officer safety with complete situational awareness and real-time decision-making
- Increase productivity and efficiency by streamlining evidence management
- Protect evidence with fault-tolerant devices and secure storage from the DVR to the cloud

## Intel Components

Intel® Core™ i3-4005U processor

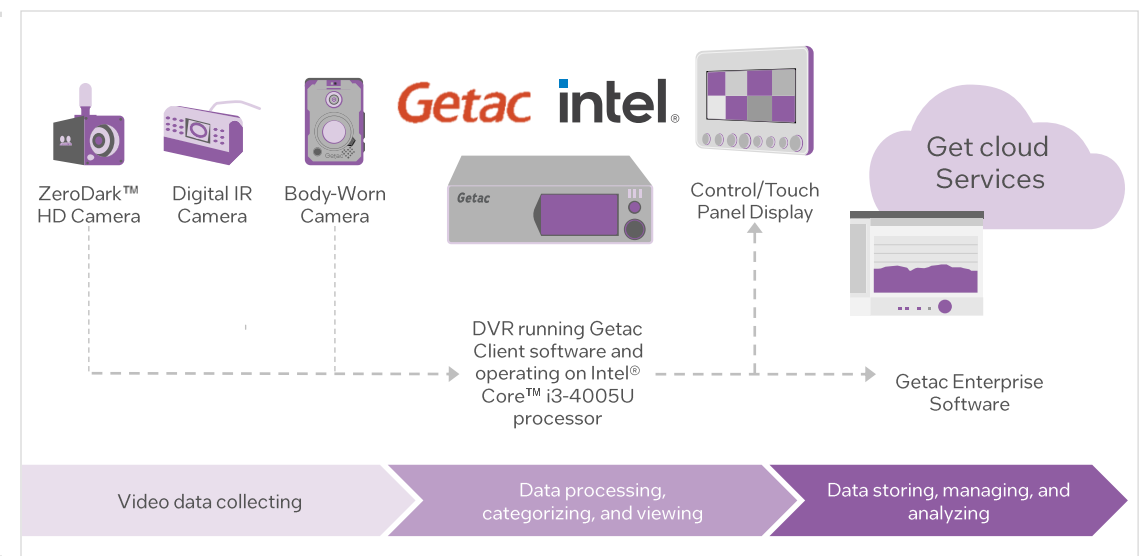

**Target Vertical:**  
Government

**Secondary Verticals:**  
Transportation

**Target Use Case:**  
Situational Monitoring

**Secondary Use Case:**  
Environmental Monitoring, Human Wellness Monitoring

**Geo Availability**  
U.S. and Canada

**Learn More**  
[Getac Video Solutions website](#)

# Giada Digital Signage Management

## Solution Overview

A system of business and industrial-grade media players that are part of a new generation of intelligent digital signage, these displays provide information directly to patrons in a physical space for various industries and scenarios

## Value Props

Simplify hardware architecture with a flexible application to meet the needs of the system

Streamline operations through processes to control technology and maintenance

Save time through a customized service

## Intel Components

- Intel Atom® Processors
- Intel® Core™ i5 Processors
- Intel® Celeron® Processors
- Intel® Distribution of OpenVINO™ Toolkit
- Intel® Core™ i3 Processors

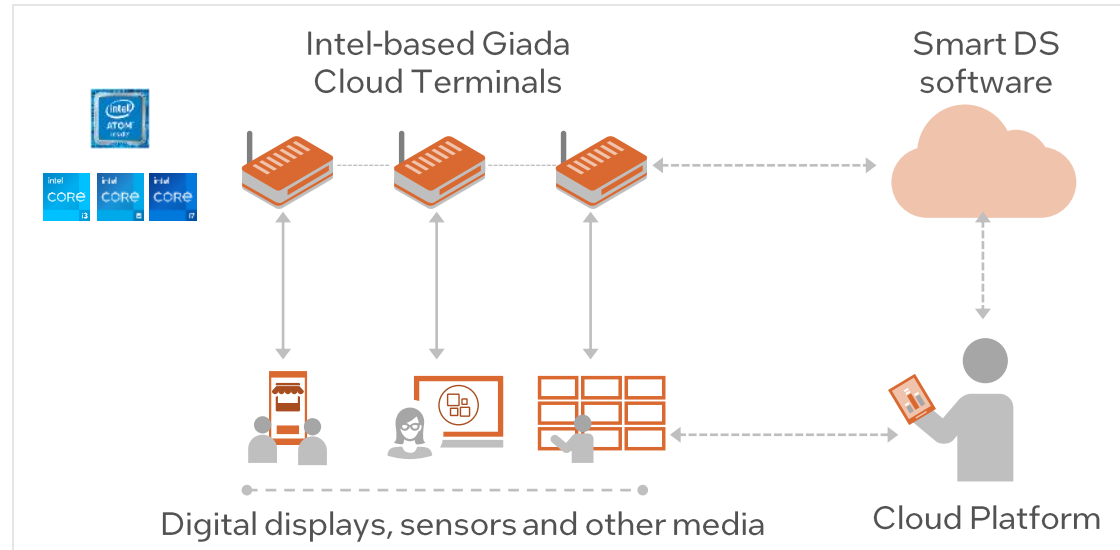

**Target Vertical:** Retail  
**Secondary Verticals:** Hospitality, Health & Life Sciences, Transportation

**Target Use Case:** Interactive Media

**Geo Availability**  
 APAC and Greater China

### Learn More

- The Giada Website [here](#)
- To order the Giada Digital Signage Management solution, please contact Tony Liu, the Giada Marketing Director, at [Tony@giadatech.com](mailto:Tony@giadatech.com)





# Graymatics AI Driven Advanced Video Analytics

## Solution Overview

Graymatics AI Driven Advanced Video Analytics transforms CCTV technology by creating software that derives contextual metadata from video footage using an advanced AI-driven analytics platform. Going beyond simply capturing camera footage, this solution can track events and help customers identify patterns.

## Value Props



**Increase operational efficiency** through automated analysis and annotation of captured video footage, eliminating the need for human examination



**Understand consumer behavior** through technology that identifies consumer purchase decisions in real-time



**Protect people** through automatic recognition and identification of key descriptors

## Intel Components

- Intel® Core™ i7 Processors
- Intel® Movidius™ Myriad X® VPU

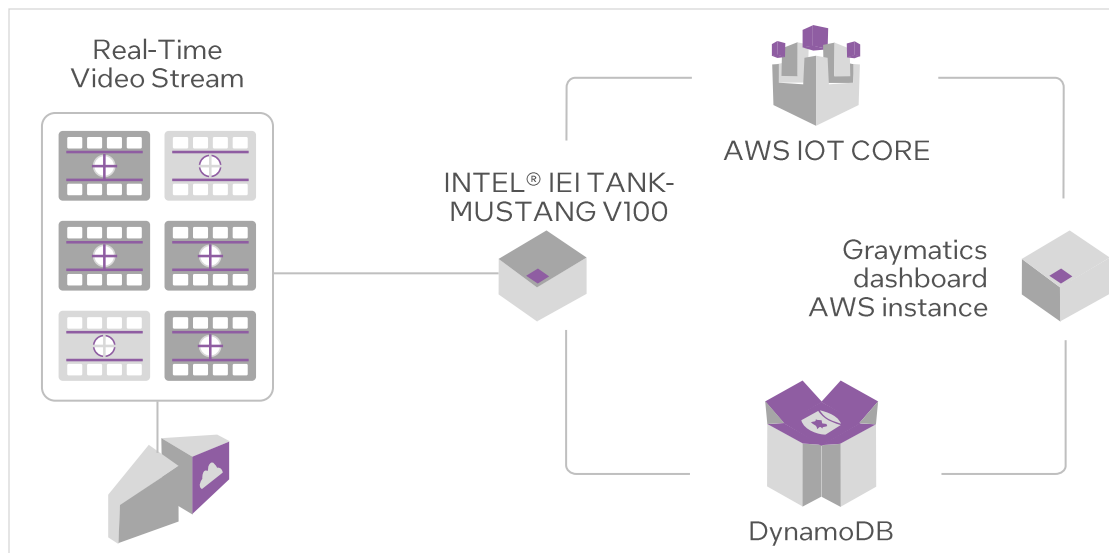

**Target Vertical:**  
Government

**Target Use Case:** Asset & Operations Optimization

**Secondary Use Cases:** Banking/FSI, Hospitality, Education, Health & Life Services, Transportation, Manufacturing, Smart City, Building Management

**Geo Availability**  
Asia, Japan, Middle East, Australia

## Learn More

- [Graymatics website](#)

# Grupo MSA – Electronic Ballot System (EBS) by vot.ar

## Solution Overview

The Grupo MSA – Electronic Ballot System (EBS) by vot.ar is a solution that provides self-service electronic voting machines with dynamic displays and integrable technology. This solution allows governments to streamline voting and to provide a safer alternative to traditional and DRE systems

## Value Props



Provide an easy-to-use system by increasing ballot availability and accessibility



Protect against voter fraud and reduce errors with strict security procedures and checks that prevent double counting votes



Increase voter confidence with manual and electronical auditability options

## Intel Components

- Intel® Atom® Processors
- Intel® Celeron® Processors

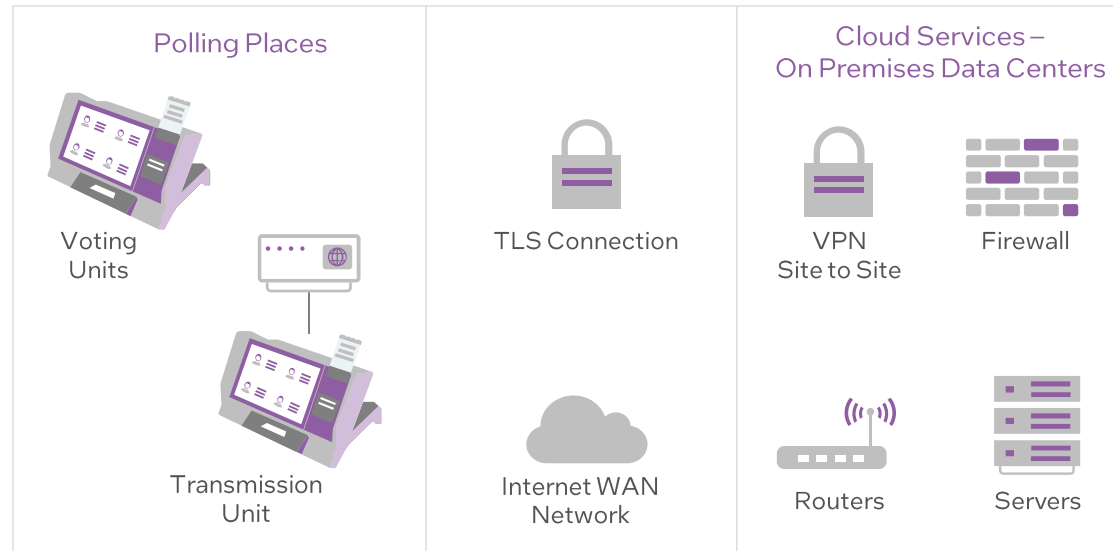

Target Vertical:  
Government

Target Use Case:  
Interactive Media

Geo Availability  
LAR

### Learn More

- Grupo MSA [Grupo MSA Website](#)
- Intel Solutions [Marketplace](#)

# Hangzhou Century Co. Fashion Industry IoT Solution

## Solution Overview

An EAS and RFID technology-based solution, built on Intel® IoT technology, that enables retail transformation for more efficient inventory and supply chain management

## Value Props



Enhance the customer experience through smart fitting, simplified checkout, and magical-mirror guide



Streamline sales and operational processes with item-level tagging for easy inventory counting, smart checkout, and product authentication



Improve inventory control with enhanced sales prediction, theft and loss prevention, and out-of-stock management

## Intel Components

- Intel® RFID Sensor Platform (Intel® RSP)
- Intel®-based gateway
- Intel® Core™ i5 processor-based workstation

The Architecture of Century Apparel RFID Platform

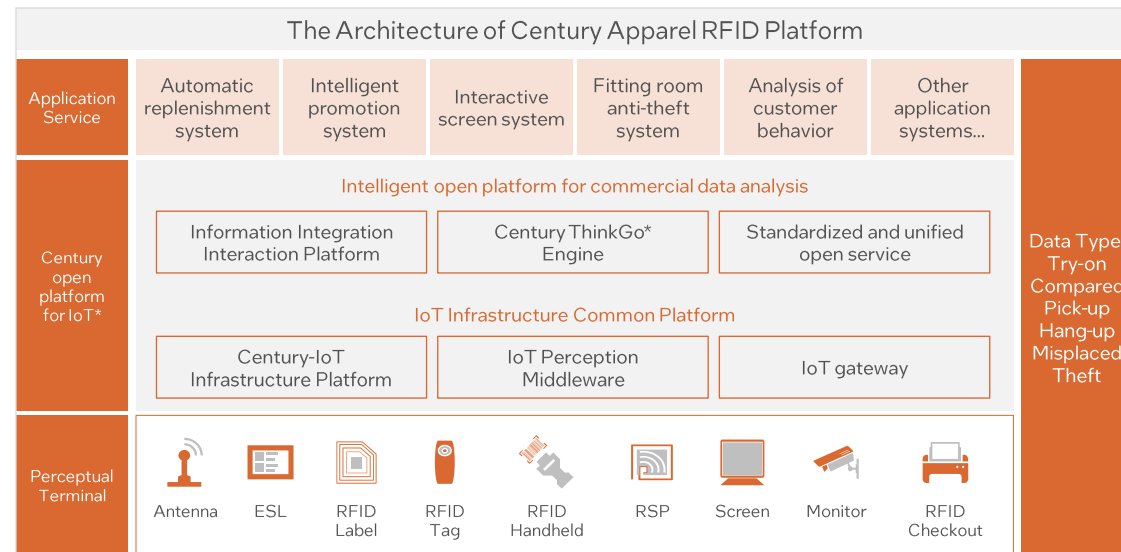

Target Vertical: Retail

Secondary Vertical: Manufacturing

Target Use Case: Logistics & Tracking

Secondary Use Cases: Interactive Media, Situational Monitoring, Product Inspection

Geo Availability Available in China

### Learn More

- [RFID Smart Store Video](#)
- [Century RFID supply chain management solution video](#)



## Hikrobot: iWarehouse Intelligent Management Warehouse

### Solution Overview

A warehouse management system that uses a mobile robot and control system to improve storage efficiency.

### Value Props



**Optimize warehouse storage** through demand analysis of available storage and automatic shelf adjustments



**Streamline warehouse management** by supporting inventory business processes



**Gain total control** with flexible management strategies, user-based permission configuration, and warehouse visualization

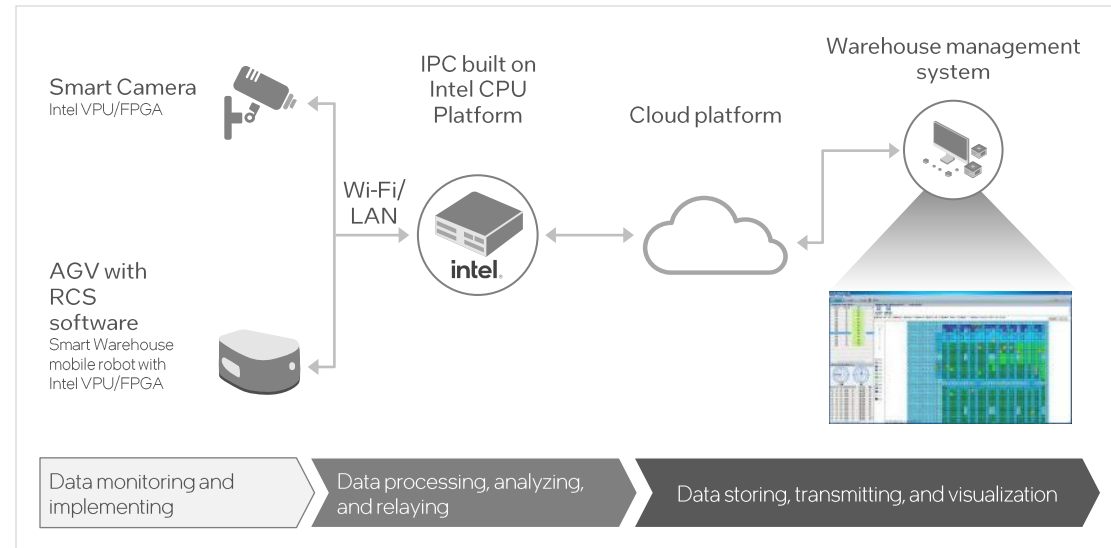

### Intel Components

- Intel® Movidius™ Myriad™ VPU
- Intel® Xeon®
- Intel® FPGA
- Intel® Core™ based CPU Platform

**Target Vertical:**

Manufacturing

**Secondary Vertical:** Retail

**Target Use Case:**

Situational Monitoring

**Secondary Use Case:**  
Logistics & Tracking

**Geo Availability**

Available in North America, APJ, PRC, APAC, and EMEA

**Learn More**

- [Hikrobot iWMS solution webpage](#)
- [AGV robot demo video 1](#) and [video 2](#)



# HiteVision Interactive Classroom Broadcasting Solution

## Solution Overview

The HiteVision Interactive Classroom Broadcasting solution is an interactive solution enabling remote teaching and lesson management in dual-teacher class environments. Through a “cloud + terminal” model, the solution allows educators to manage detailed teaching plans in collaboration with support staff, without requiring professional audio-visual equipment. HiteVision fits a variety of classroom styles, including participatory lectures and listening-only classrooms. It allows all students within a class, facility, or district to benefit from high-quality educational tools and connectivity.

## Value Props



**Provide a consistent and equitable educational experience** by allowing a core group of educators to effectively support students, regardless of location, with consistent, engaging, and high-quality educational resources



**Streamline lesson planning and material distribution** using the integrated teaching plan and management software to seamlessly plan courses and manage students’ accounts and devices



**Implement data driven insights** by leveraging automated student performance monitoring that tracks student’s test scores, work performance, and engagement so educators can make informed alterations to their lesson plans to optimally address the needs of their students

Target Vertical:  
Education

Target Use Case:  
Interactive Media

Geo Availability  
People’s Republic of China

Learn More  
▪ [Solution website](#)  
▪ [About HiteVision](#)

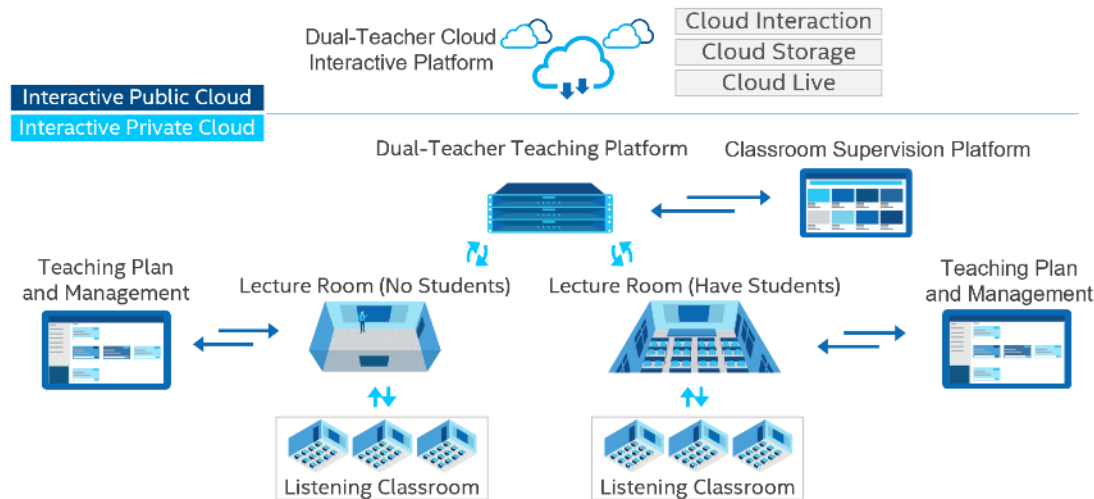

## Intel Components

- Intel® Core™ i3, i5, and i7 Processors
- Intel® Media SDK



## Honeywell Airport Solutions

### Solution Overview

The Honeywell EBI enables the Airport Platform with an easy-to-use, intelligent solution that facilitates building management, safety, security, and communications systems, ground and air traffic control, utility management, situational monitoring, airfield operations, and other airport use cases. This solution coordinates activity by integrating systems, teams, workflows, and devices across facilities and airport special systems. The solution enables airport developers and operators to command and control their united edge with ease and execute efficiently.

### Value Props



Streamline labor and operational efficiency with access to real-time data and communications



Enhance situational awareness with a platform that unites a vast range of security edge devices



Help maximize ROI and reduce costs with a platform that can reduce flight delays and streamline cargo and luggage management



Optimize energy consumption with AI that helps track consumption and deliver insights to help optimize energy usage

### Intel Components

- Intel® Xeon® E3 Processors
- Intel® Core™ i3, i5, and i7 Processors
- Intel® NUC
- Intel® Media SDK
- Intel® Atom® Processors
- Intel® Ethernet Products up to 10GbE

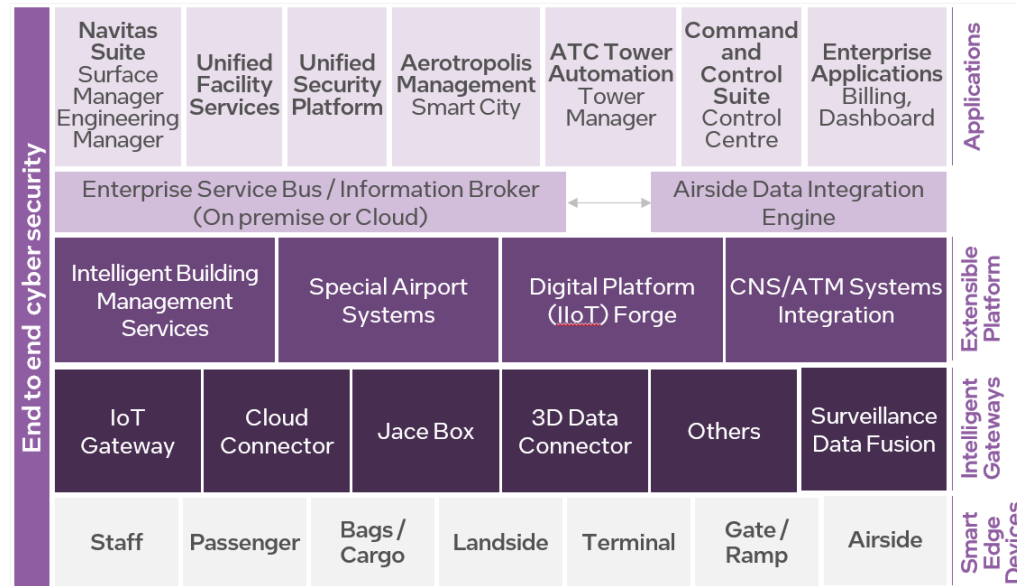

### Target Vertical:

Government

### Secondary Vertical:

Energy, Transportation & Warehousing

### Target Use Case:

Asset & Operations Optimization

### Secondary Use Case:

Control Optimization & Autonomy, Energy Monitoring & Management, Environmental Monitoring, Situational Monitoring

### Geo Availability

APJ, Americas, EMEA, PRC

### Sales Contact:

Deepak Kashyap –  
deepak.kashyap2@honeywell.com

### Learn More

[Airports | Honeywell Building Technologies](#)



## Honeywell City Suite Safe Cities

### Solution Overview

As cities and urban environments continue to grow in population and infrastructure, city officials and community leaders are facing the increasingly complex challenge of managing, monitoring, and operating systems such as traffic control, CCTV cameras, and more. To help cities address this challenge, Honeywell leveraged the Honeywell City Suite to develop its Safe Cities program, a comprehensive platform that gives community stakeholders the required insights and visibility to coordinate every aspect of complex city management. From day-to-day public property monitoring to coordination during an emergency situation, Honeywell City Suite integrates data collected from various systems such as security cameras, traffic management, parking management, waste management, lighting, energy and more to deliver real-time insights to inform decisions and facilitate rapid incident response to help create safer cities.

### Value Props



**Reduce incident response time** by deploying a platform that uses real-time video analytics to enable automatic anomaly detection, geo locating, and city resource availability & assignment to identify the most efficient response route for emergency responders



**Improve operational efficiency and compliance** with a solution that facilitates the use of a structured Standard Operating Procedure with closed loop incident handling that can be audited in addition to an integrated Computer Aided Dispatch (CAD) system to reduce time for emergency call dispatching

### Intel Components

- Intel® Xeon® SP Silver
- Intel® Core™ i5 Processors

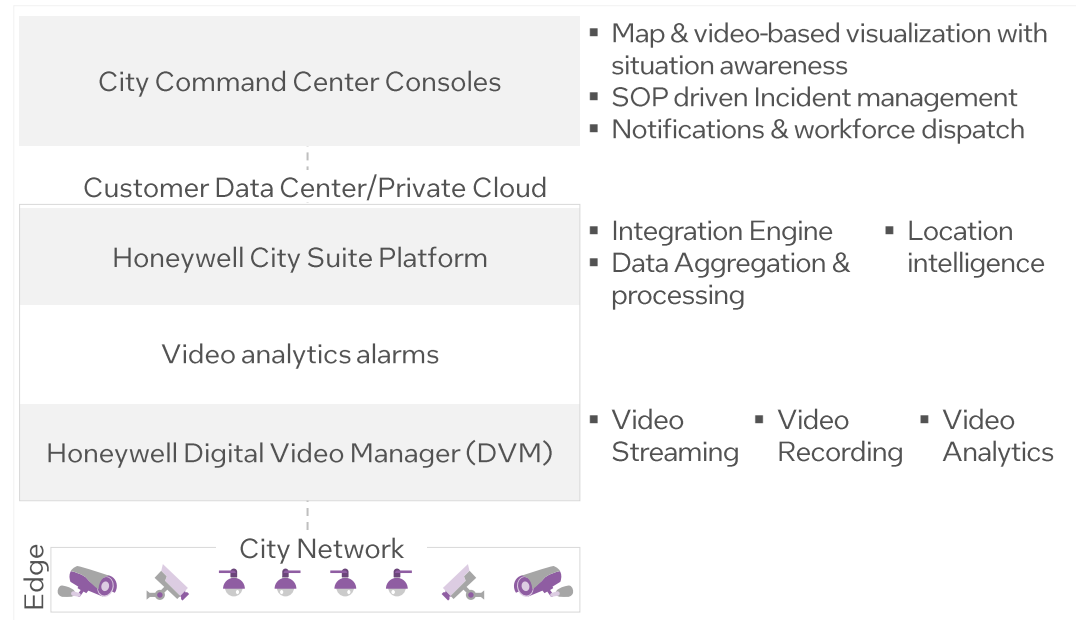

### Target Vertical:

Government

### Target Use Case:

Situational Monitoring

### Geo Availability:

Asia, Americas, Europe, Middle East, Africa

### Sales Contact:

Vivek Varma – [vivek.varma@honeywell.com](mailto:vivek.varma@honeywell.com)

### Solution Webpage:

[Honeywell Building Technologies Website](#)

### Learn More:

[Honeywell Website](#)



# HuaDian Intelligent Energy Management

## Solution Overview

A lightweight smart energy solution purpose-built to meet the demands of modern grids and systems to help businesses and governments realize comprehensive energy monitoring and management

## Value Props

- Save on energy costs** by managing energy across sites remotely from a centralized platform
- Increase operational efficiency** by predicting failures and intelligently optimizing energy workloads
- Improve worker safety** by reducing on-site maintenance calls and identifying hazardous conditions remotely

## Intel Components

- HuaDian SEG-550 Smart Energy Gateways based on Intel Atom® processors
- HuaDian SEK-6460 Terminal Equipment based on Intel® Core™ vPro™ processors
- HuaDian Smart Energy Cloud Service Platform on 3<sup>rd</sup> party platform (Alibaba AliCloud) or Intel® Xeon® processor-based CSP

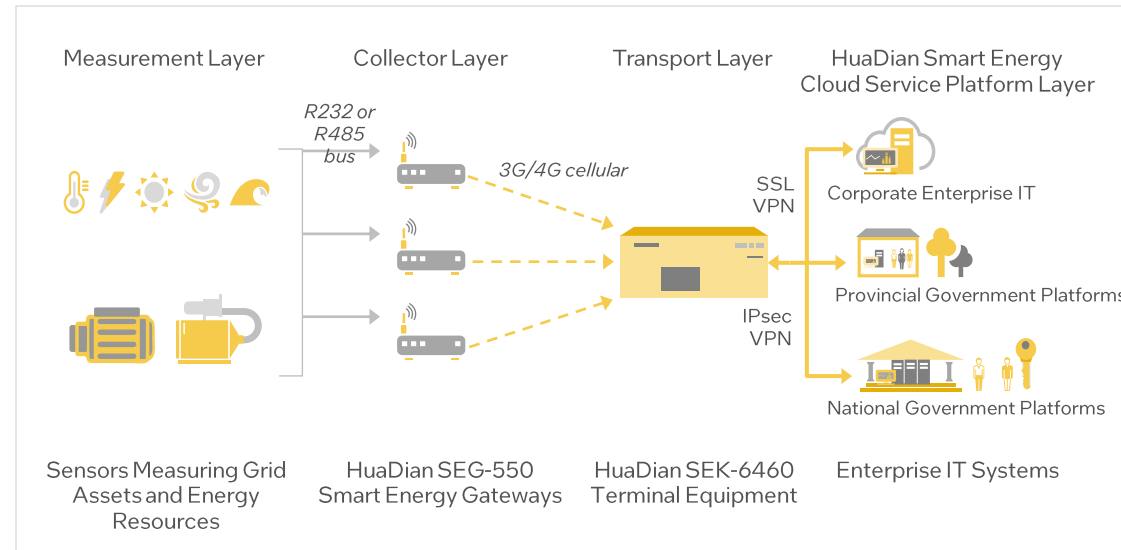

**Target Vertical:** Energy

**Secondary Verticals:** Government

**Target Use Case:** Energy Monitoring & Management

**Secondary Use Cases:** Machine Condition Monitoring

**Geo Availability:** China, US, Europe, Asia

## Learn More

- [Lanner Inc. Power and Energy Solutions](#)



# Hubz Smart Stores

## Solution Overview

Smart Stores by Hubz is a smart vending solution automates the vending process for distinctly smooth self-service. Vending operators can offer fresher, healthier products and securely operate micro-markets, while retailers can provide customers with 24/7 availability of select products. Smart Stores helps businesses increase efficiencies and implement valuable insights based on inventory and customer behavior.

## Value Props



Enhance customer experiences through frictionless digital-physical self-service



Drive efficiencies by enabling flexible planogram of multiple SKU's on one plate



Gain valuable insights into consumer behavior and inventory levels with real-time visibility

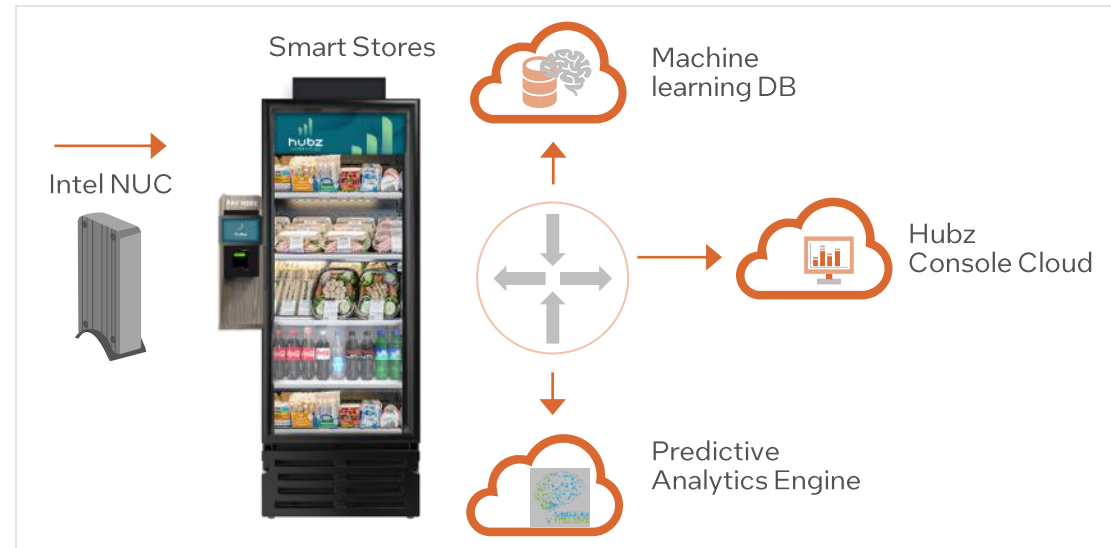

## Intel Components

Intel® NUC

Target Vertical: Retail

Target Use Case: Logistics & Tracking

Secondary Use Case: Interactive Media

Geo Availability  
US, EMEA

Learn More  
[Hubz Smart Stores webpage](#)



# HY Medical AI-Assisted Diagnosis of Medical Imaging on IA Solution

## Solution Overview

Hitachi Vantara's Smart Spaces and Lumada Video Insights provides the Intelligent Behavior Monitoring for Healthcare and Life Sciences solution that has the potential to deliver an immediate value for healthcare organizations through real-time monitoring of patient activity, worker health, and facility operations.

## Value Props

- Increase diagnostic accuracy** for a variety of conditions and diseases with advanced AI software for medical imaging
- Improve work efficiency** with powerful computing that can rapidly detect a lesion area, analyze it, and segment it automatically for facilitated viewing
- Mitigate personnel shortages** with advanced AI systems that leverage hospital image data to produce results and help close medical experience gaps

## Intel Components

- Intel® Core™ i5 Processors
- Intel® Xeon® Processors
- Intel® Distribution of OpenVINO™ Toolkit

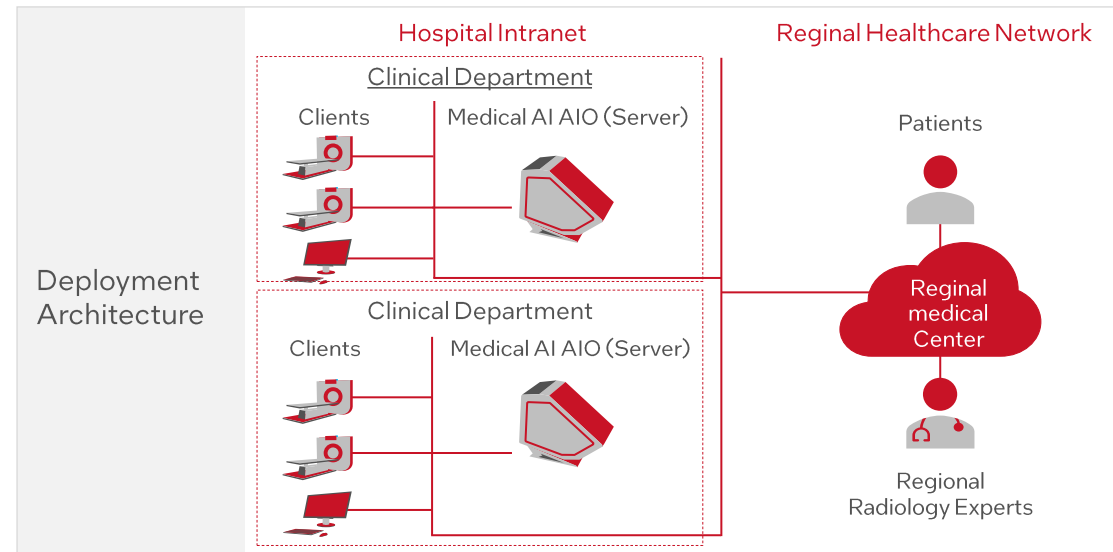

Target Vertical: Health & Life Sciences

Target Use Case: Product Inspection

Geo Availability  
Asia/Pacific/Japan; PRC; EMEA; Americas.

### Learn More

- [HY Medical Intel Website](#)
- [Solution Demo Platform](#)
- [Solution Video](#)
- [Solution Documentation](#)

# The Hark Platform

## Solution Overview

The Hark Platform consists of the Hark Connect, Hark Analytics, and Hark Energy Tools software suite. This cloud-based sensor platform helps businesses monitor, manage, regulate, and optimize electrical and mechanical operations across a diverse range of asset classes and devices by processing and analyzing millions of sensor readings in real-time. Captured data is ported via a wide range of protocols to produce rich user-friendly dashboards and visualizations. Data can also be leveraged to create nuanced event triggers and alerts, as well as complex automation processes.

## Value Props



Save money and carbon by reducing excess consumption through a solution that monitors high volumes of data to fine tune automated processes and mitigate risks



Enhance the performance of industrial systems through real-time alerts, benchmarks, reports, triggers, events, and other automated protocols without costly hardware replacements



Achieve seamless interconnectivity by uniting a wide range of devices through a dynamic data network to streamline and optimize complex operations

### Solution Components

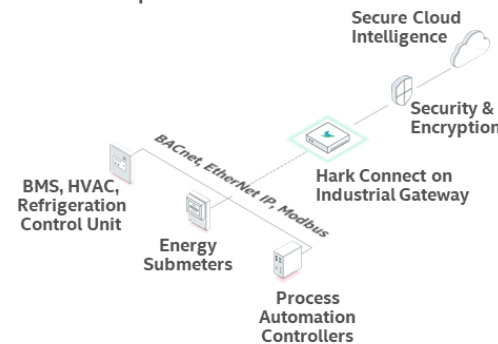

### Gateway Platform

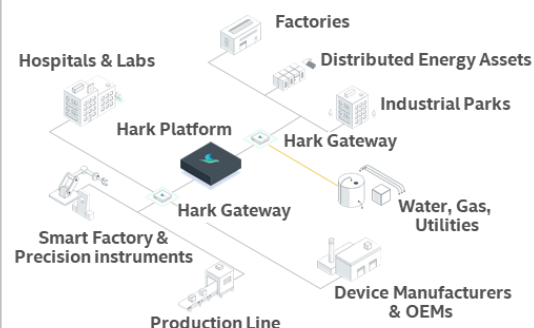

## Intel Components

Intel® Atom® Processors

**Target Vertical:**  
[Manufacturing](#)

**Secondary Verticals:**  
[Agriculture](#); [Energy](#); [Health & Life Sciences](#); [Hospitality](#); [Retail](#)

**Target Use Case:**  
[Energy Monitoring & Management](#)

**Secondary Use Cases:**  
[Asset & Operations Optimization](#); [Environment Monitoring & Management](#); [Logistics & Tracking](#); [Machine Condition Monitoring](#)

**Geo Availability**  
Canada; United States; Germany; United Kingdom

### Learn More

- [Hark Homepage](#)
- [Solution documentation](#)
- [Solution architecture](#)

# HOOBOX Robotics Neonpass

## Solution Overview

The HOOBOX Robotics Neonpass is a patient pre-check-in and document eligibility verification kiosk solution that automates patient admission on the administrative side, and also allows staff to track patients inside the hospital to ensure security and avoid fraudulent actions. Additionally, the kiosk helps streamline the patient experience as patients who have pre-checked-in can be admitted inside the hospital through the touchless kiosk by face recognition identification. This helps avoid delays and reduces patient admission costs for the hospital.

## Value Props



Increase patient satisfaction with a seamless experience that streamlines the check-in process and reduces wait times



Reduce costs by 35% to 85% on manual patient administration processes with pre-check in, with staff freed up to perform other valuable tasks



Improve patient data collection, retention, and privacy with a digital application that brings questionnaires to the patient's personal devices for easy accessibility and participation, increasing the number of completed forms by up to 23%

### INVITATION.

### ONLINE CHECK IN.

### ACCESS.

#### Simple 3 Steps

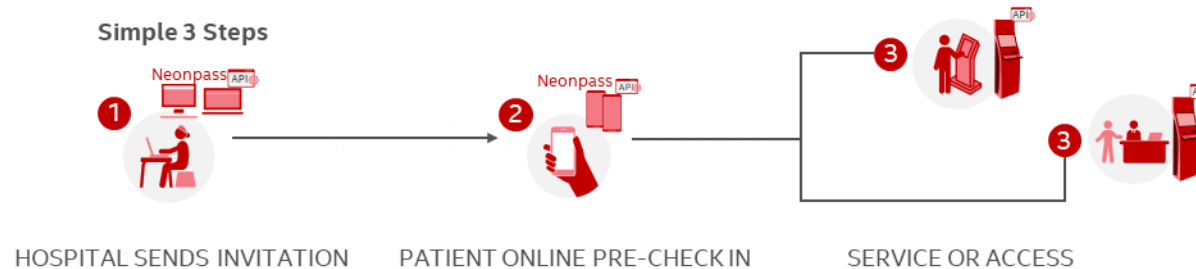

## Kit Components

- Intel® NUC
- Intel® Distribution of OpenVINO™ Toolkit
- Intel® RealSense™ Technology

### Target Vertical:

Health & Life Sciences

### Secondary Vertical:

Education

### Target Use Case:

Asset & Operations Optimization

Secondary Use Case: Human Wellness Monitoring

### Geo Availability

Brazil, Canada, Mexico, United States, Other Americas, Middle East, North Africa and Turkey

### Learn More

- [HOOBOX website](#)
- [HOOBOX Neonpass landing page](#)



# i3-Technologies Hybrid Teaching

## Solution Overview

The i3-Technologies Hybrid Teaching Solution provides a comprehensive portfolio of cloud-based technologies for education institutions. Information is displayed at the edge and distributed via the cloud to the i3LEARNHUB platform. IT managers can use i3RDM to monitor their interactive screens, view usage data, remotely roll out updates, and ensure compliance and enhance device security.

**Target Vertical:** [Education](#)  
**Secondary Verticals:** [Public Sector/Government](#)

## Value Props

-  Provide interactive learning opportunities to students, turning physical and digital classrooms into collaborative workspaces
-  Monitor data infrastructure security with the latest privacy and infrastructure security requirements
-  Improve efficiencies of network devices, install apps, and view usage data

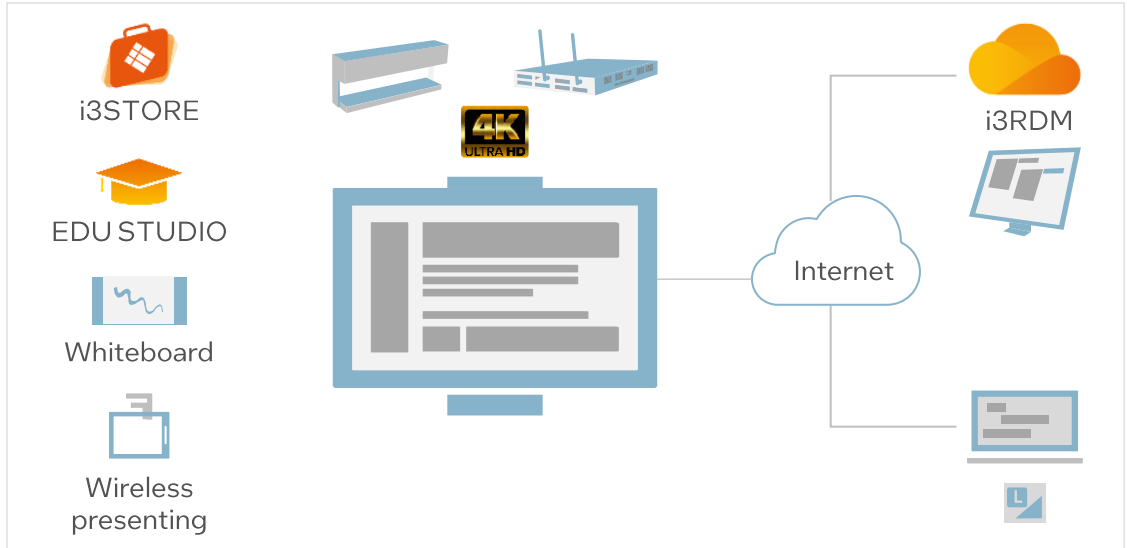

**Target Use Case:** [Interactive Media](#)  
**Secondary Use Cases:** [Human Wellness Monitoring](#)

**Geo Availability**  
 Globally

**Learn More**  
[i3 Website](#)

## Intel Components

Intel® Core™ i3, i5, or i7 processors



# Imedtac iVMS Intelligent Vital Signs Station

## Solution Overview

The iVMS Intelligent Vital Signs Station is a smart all-in-one wellness diagnostic kiosk that measures vital sign tests like height, weight, blood pressure, heartbeat, and temperature. Collected data can be upload to the cloud or even connect the hospital data systems directly to the cloud for data access.

## Value Props

- Measure vital signs quickly and accurately
- Streamline operations by allowing visitors to check their vital signs themselves, freeing up staff
- Manage patient data easily by automatically uploading data to the cloud and access data through a Hospital Information System

## Intel Components

- Intel® Core™ i3 Processors
- Intel® Core™ i5 Processors
- Intel® Atom® Processors

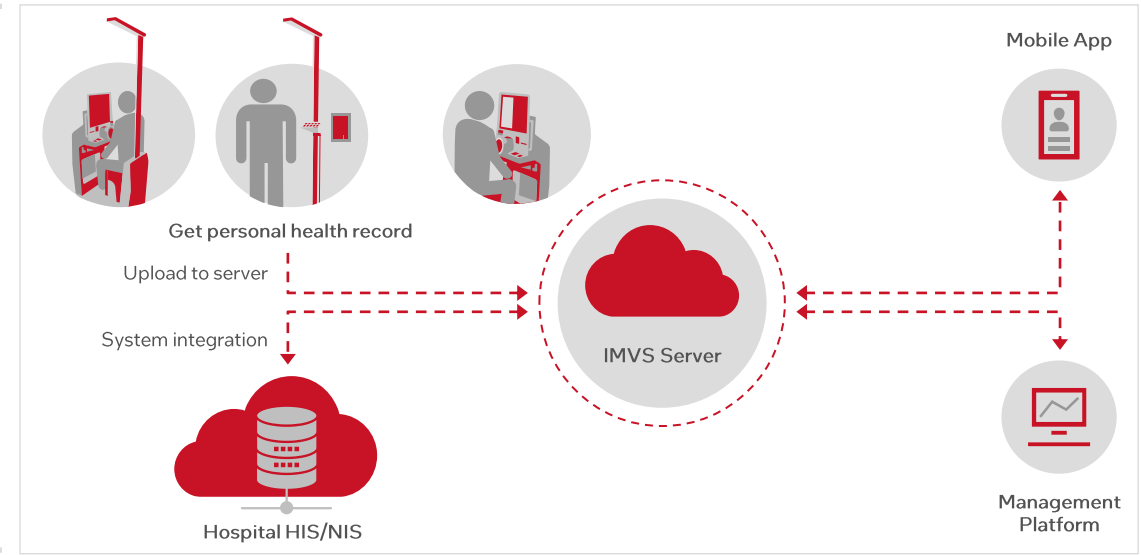

**Target Vertical:** Health & Life Sciences  
**Secondary Verticals:** Banking/Financial Services; Education; Government; Manufacturing; Retail; Transportation

**Target Use Case:** Human Wellness Monitoring  
**Secondary Use Case:** Interactive Media

**Geo Availability**  
 Brazil, Canada, Mexico, United States, Other Americas, Australia/New Zealand, India, Japan, South Korea, People's Republic of China, Taiwan, Germany, Israel, Middle East, North Africa, Turkey, Russia, Sub-Saharan Africa, United Kingdom

**Learn More**  
[Imedtac website](#)

## Solution Overview

inefi Spotlight, is the first smart Unified Endpoints Management (UEM) service which can monitor and manage both computing devices and the very endpoints which serve as the peripherals. The system combines edge hardware compute, a management platform, and support services to deliver custom solutions that suit any retail environment, as well as a range of other verticals that rely on edge peripherals and technology. inefi Spotlight leverages consistent, automated edge device monitoring and management, enabling deep infrastructure awareness and control for seamless operations throughout the network.

## Value Props



**Maximize system uptime** with automated remote monitoring, maintenance, and issue resolution throughout an entire peripheral ecosystem



**Increase system-wide efficiency** by visualizing all operational processes and surfacing accurate insights for data-driven operational decisions



**Simplify system management** with intuitive controls for remote device management, configuration, and user access profiles

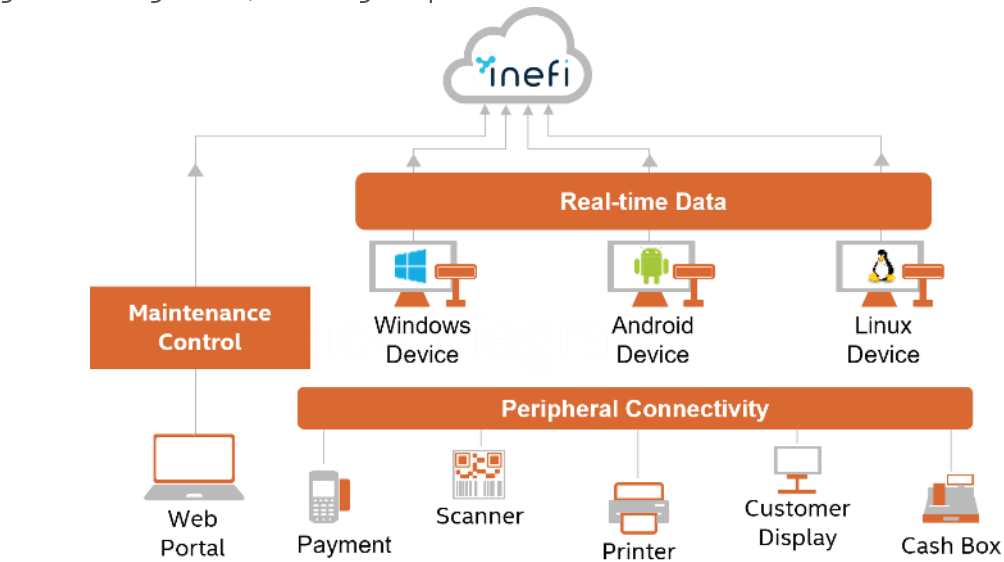

## Intel Components

- Intel® Celeron® Processors
- Intel® Core™ i3, i5 Processors
- Intel® NUC
- Intel® Solid State Drives
- 10gb Intel® Ethernet network adapters
- Intel® RealSense™ Technologies

**Target Vertical:**  
Retail, Hospitality

**Secondary Verticals:**  
Banking/Financial Services, Education, Gaming & Entertainment, Government, Health & Life Sciences, Manufacturing, Transportation

**Target Use Case:**  
Asset & Operations Optimization

**Geo Availability**  
United States, Canada, United Kingdom, Europe, Japan, and Taiwan

## Learn More

- [inefi Spotlight website](#)
- [inefi Spotlight product brochure](#)
- [Solution user guide](#)
- [Solution White Paper](#)

# IDIS Solution Suite and IDIS Center

## Solution Overview

IDIS Center is a license-free video management software (VSM) for integrated management on IDIS products with the ability to live monitor up to 1,024 IDIS devices and provide video playback. IDIS Solution Suite is a VMS, requiring a one-time license fee, that integrates with third-party systems to manage an unlimited number of IDIS devices and compatible third-party systems and offers advanced functions such as backup, failover, streaming, and federation. The data gathered is then aggregated to provide real-time security notifications when threats arise.

## Value Props



**Help manage safety and security with ease** with an end-to-end solution providing sourcing equipment, management software, and accessories



**Decrease operational costs** with FEN solution that's quick to install and integrates with existing systems



**Increase system performance** with multi-channel video recording through failover, backup, and redundancy functionalities

## Intel Components

- Intel® Core™ i7 Processors
- Intel® Atom® Processors

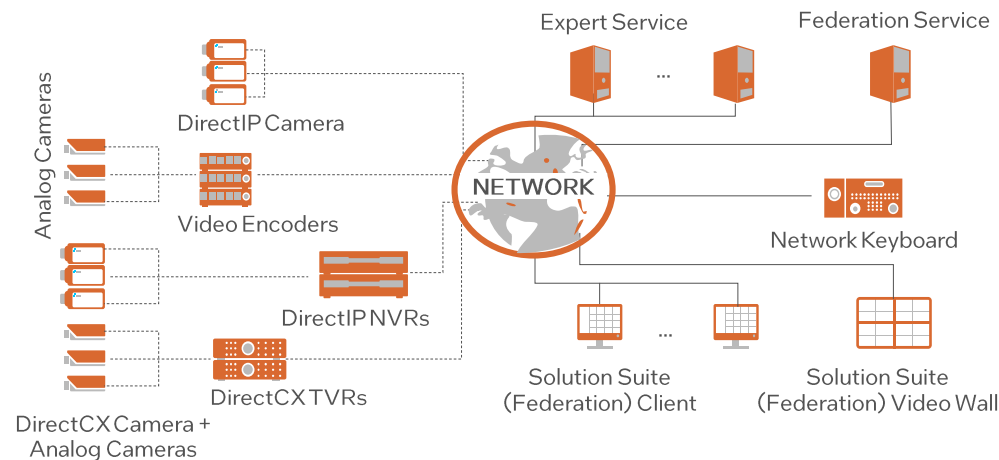

**Target Vertical:**  
Retail

**Secondary Vertical:**  
Banking/Financial Services

**Target Use Case:**  
Loss Prevention, Situational Monitoring and Awareness

**Secondary Use Cases:**  
Asset Protection, Tracking, Analysis and Action

**Geo Availability**  
Globally

- Learn More**
- [IDIS Website](#)
  - [IDIS Solution Suite Website](#)
  - [IDIS and NDAA Compliance](#)



# Indra Sistemas Onesait Sustainability Waste Citizen

## Solution Overview

The Sustainability Waste Citizen is a reverse vending machine that distributes rewards and discounts in exchange for recyclable materials. Individuals recycle waste in the RVM which then sorts the materials. Data is collected on the materials in exchange for rewards. Additional metrics are collected to generate key insights to manage everything from outreach campaigns, to collection routes, reports, and more.

## Value Props

- Deploy solutions through an easily managed system capable of swiftly defining critical functionalities, on-boarding partners, and integrating with new campaigns
- Stabilize and evolve program participation by implementing a system that facilitates new initiatives through Onesait and the Circular Economy program, along with public-private collaboration models
- Accelerate scaling and adoption with a solution capable of identifying and developing synergies between program stakeholders, markets, legal frameworks, and public interests

## Intel Components

Intel® Celeron® Processors

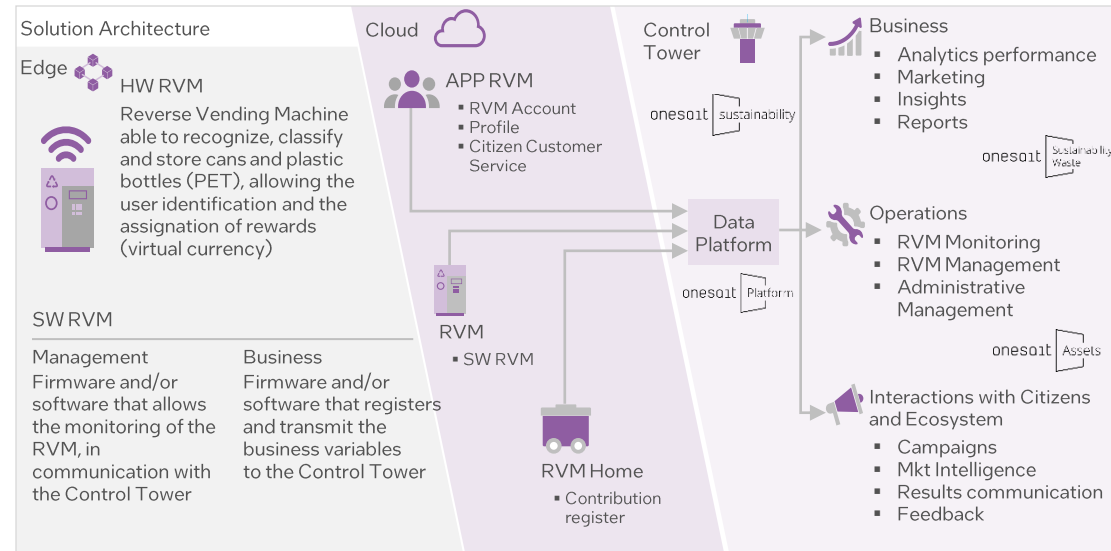

**Target Vertical:**  
Government

**Secondary Verticals:**  
Hospitality, Retail

**Target Use Case:** Asset & Operations Optimization

**Secondary Use Cases:**  
Interactive Media

**Geo Availability**  
Mexico; Other Americas;  
Germany; Middle East,  
North Africa and Turkey;  
United Kingdom

## Learn More

[Onesait Sustainability | Build a Circular Economy optimizing waste Management](#)



# Industrial Network Security with Monitor for secunet edge

## Solution Overview

Secunet edge – Secunet’s secure edge solution – Addresses cyber threats by enhancing the security and quality of connected IT and OT devices within industrial networks. Also using the secunet monitor, secunet has developed a comprehensive and cost-effective approach to edge computing while mitigating risks.

## Value Props



Increase operational convenience and efficiency with user-friendly, flexible, and scalable edge appliances



Enhance security with secure appliances and fitting security apps, such as comprehensive network security monitoring



Reduce TCO with a comprehensive platform solution that supports multiple use cases and requires less maintenance

## Intel Components

- Intel® Core™ i5
- Intel® Atom® Processors
- Intel® Ethernet Controller

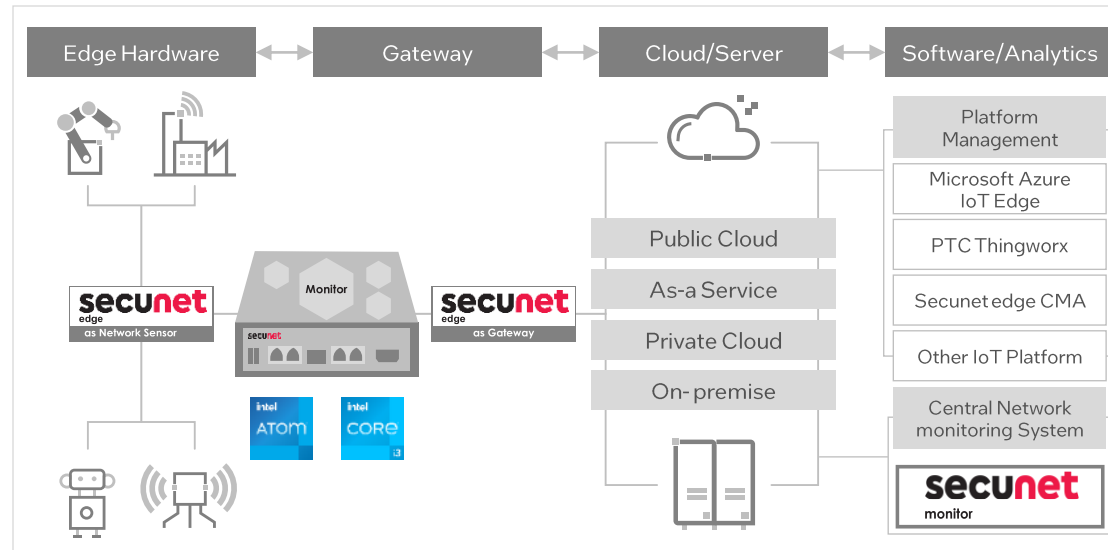

Target Vertical: [Manufacturing](#)  
 Secondary Verticals: [Agriculture](#), [Banking/Financial Services](#), [Energy](#), [Government](#), [Health & Life Sciences](#), [Transportation](#)

Target Use Case: [Situational Monitoring](#)  
 Secondary Use Cases: [Asset & Operations Optimization](#), [Control Optimization & Autonomy](#), [Environmental Monitoring](#), [Logistics & Tracking](#), [Machine Condition Monitoring](#), [Product Inspection](#)

Geo Availability  
 Available in Australia/New Zealand, Germany, Middle East, North Africa and Turkey, Sub-Saharan Africa, United Kingdom

Learn More  
 ▪ [Secunet website](#)

# IntraEdge and Pyramid Janus

## Solution Overview

Janus is an enterprise-level contactless, self-check temperature kiosk that puts privacy first. Powered by an Intel® i5 processor, Janus can quickly scan and provide accurate temperature results within seconds. With privacy as a priority, Janus is also powered by Truyo's Privacy Rights Platform to ensure the privacy of all user data and offers users the ability to access their data with transparency.

## Value Props



Leverage a turn-key market ready solution that supports the health and privacy of personnel



Integrate seamlessly with HR systems using an intuitive UI for rapid check-in and speedy entry for employees and customers



Customize installation for any location with ease while meeting ADA requirements

## Intel Components

- Intel® Core™ i5 6500TE processors
- Intel® HD-Graphics530



**Target Vertical:** Retail  
**Secondary Verticals:** Banking/Financial Services; Education; Energy; Gaming & Entertainment; Health & Life Sciences; Hospitality; Manufacturing; Government; Transportation

**Target Use Case:** Human Wellness Monitoring  
**Secondary Use Case:** Interactive Media

**Geo Availability**  
 North America

**Learn More**  
 ▪ [IntraEdge Website](#)



# IntraEdge Truyo

## Solution Overview

A custom built, scalable enterprise solution created to meet and simplify management of the Subject Access Request requirements for GDPR compliance

## Value Props

- Drive transparency quickly with secure data collection and customizable portals for data access and management
- Streamline data management by connecting disparate systems to simplify access and using flexible automation to reduce overhead
- Enhance enterprise value with actionable insights using comprehensive data pulled from newly centralized systems

## Intel Components

- Intel®-based intelligent gateways, sensors, and software
- Intel® SGX

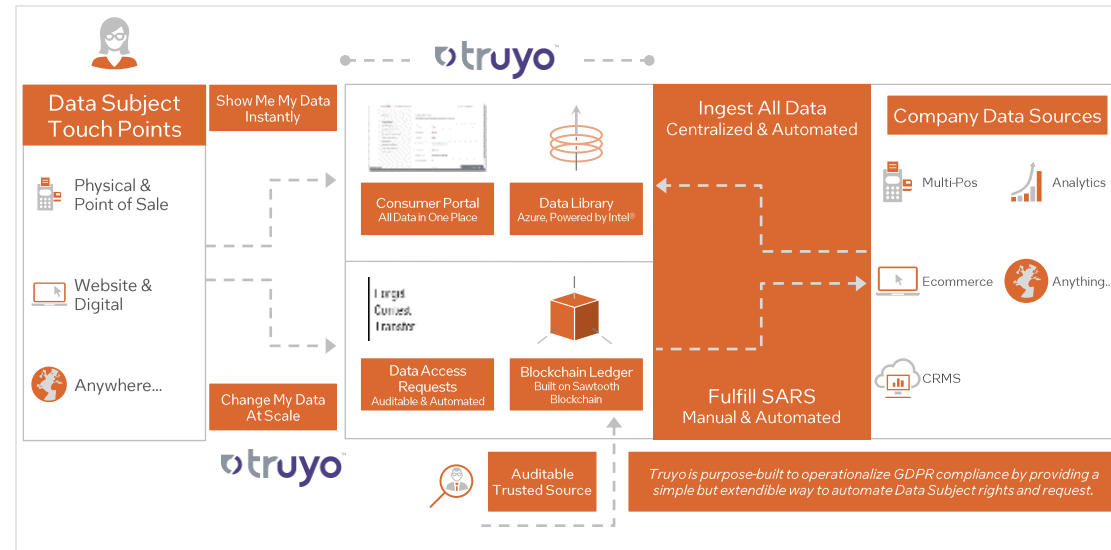

**Target Vertical:** Retail

**Secondary Verticals:** Hospitality, Health & Wellness Monitoring

**Target Use Case:** Asset & Operations Optimization

**Geo Availability**

Currently available in EMEA and the US. Opportunities in additional regions will be considered

**Learn More**

- [Truyo Website](#)
- [Intel Solutions Marketplace](#)



# Innodep VURIX

## Solution Overview

Innodep's VURIX Video Surveillance Solution is a highly scalable, all-in-one surveillance solution that monitors, records, and manages data in a single system, helping build smarter cities and improve public safety.

## Value Props



Increase public safety with multi-channel, real-time monitoring



Scale quickly and reliably with an open platform



Reduce costs and utilize your existing assets with a solution compatible with IoT devices and 3<sup>rd</sup> party applications

## Intel Components

- Intel® Xeon®
- Intel® Core™ i5 and i7
- Network Video Recorder Device
- VMS Software
- IP Matrix device
- SSD

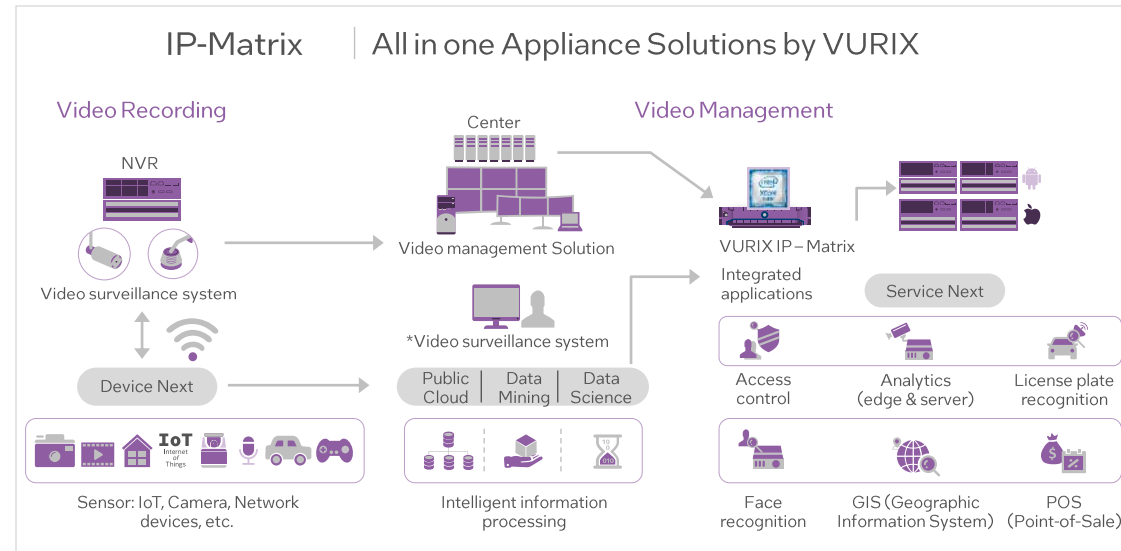

**Target Vertical:**  
Government

**Secondary Verticals:**  
Retail, Banking/Financial Services, Hospitality, Education, Health & Life Sciences,

**Target Use Case:**  
Situational Monitoring

**Geo Availability**  
APJ, Korea, Africa, Europe

## Learn More



- Learn more about Innodep solutions on the [Innodep website](#).
- Learn more about Innodep's VURIX solution [here](#).
- An in-person training course is available. For more details, click [here](#).

# Invenda Interactive Vending and Advertising Platform for Retail and Hospitality

## Solution Overview

Invenda transforms traditional vending machines into smart devices, taking full advantage of IoT technologies and Intel processing power. Invenda combines eye-popping digital signage and interactive product displays with smart sensors for remote management while integrating AI for new insights.

## Value Props

-  **Increase sales and engagement** with eye-catching vending solutions that draws customers with custom tailored offerings
-  **Reduce management and inventory costs** through Smart IoT devices with up to 150 sensors ensuring optimum performance
-  **Extend vending technology** into a variety of new verticals and open cross-channel opportunities with online, on-demand mobile technology

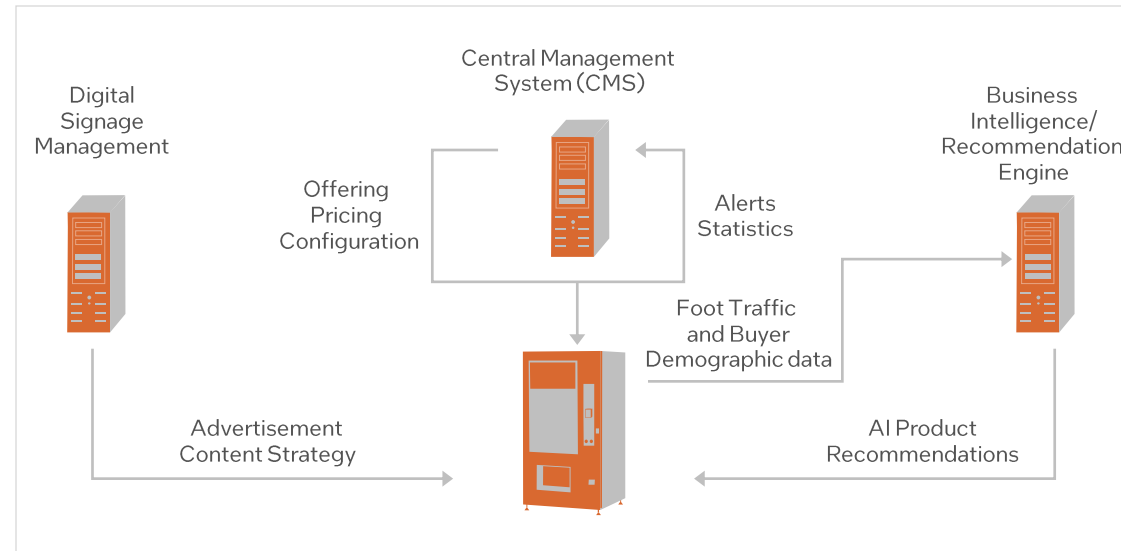

**Target Vertical:** Retail  
**Secondary Verticals:** Education, Government, Health & Life Sciences, Hospitality, Transportation

**Target Use Case:** Control Optimization & Autonomy  
**Secondary Use Cases:** Asset & Operations Optimization, Energy Monitoring & Management, Environment Monitoring, Interactive Media, Logistics & Tracking, Machine Condition Monitoring, Product Inspection, Situational Monitoring

**Geo Availability**  
 Available in Germany, UK, Europe

**Learn More**  
[Invenda Website](#)

## Intel Components

Intel® Celeron



# iOmniscient Pty Ltd IQ Roads

## Solution Overview

This solution is a comprehensive AI-based intelligent traffic management system. The solution works through virtually any camera to capture and analyze live video feeds for fast responses to emergency situations. Data analysis at the Edge supports traffic personnel action that may increase the likelihood of positive outcomes.

## Value Props



**Increase road safety** with traffic monitoring and incident detection



**Streamline monitoring processes** by viewing events remotely and centrally and accessing archived reporting and historic event data



**Increase insight into road conditions** with advanced camera diagnostics and data analysis in multiple dimensions

## Intel Components

- Intel® Distribution of OpenVINO toolkit™
- Intel® Xeon® Processors
- Intel® Core™ i5 and i7 Processors

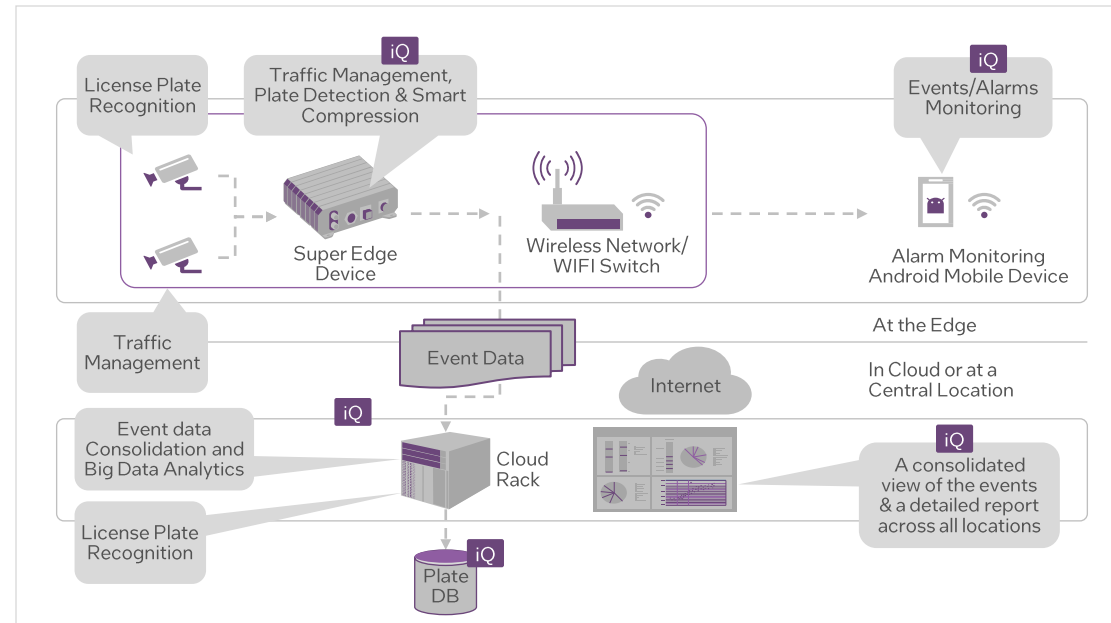

**Target Vertical:**  
Transportation

**Secondary Vertical:**  
Government

**Target Use Case:**  
Situational Monitoring

**Secondary Use Case:**  
Asset & Control Optimization

**Geo Availability**  
Worldwide

## Learn More

- [IQ Roads Features](#)
- [IQ Roads Speeding Demo](#)
- [IQ Roads Red Light Violation and LPR Demo](#)
- [iOmniscient Website](#)

# Intelligent Security Systems – SecurOS FACEx

## Solution Overview

An intelligent image analytics module for the SecurOS video management platform, which provides capture and recognition of faces from a video stream. A class leading solution with active recognition, where the solution can be configured so subjects know their image is being captured or not

## Value Props

Automatically detect and recognize faces with a powerful recognition engine

Collect information on detected faces with a databased that stores recognition data

Easily manage video data with a graphical user interface

## Intel Components

- Intel® NUC
- Intel® Xeon® Processors
- Intel® Solid State Drivers (SSD)
- Intel® Ethernet Server Adapter 1350
- Intel® Distribution of the OpenVINO™ Toolkit

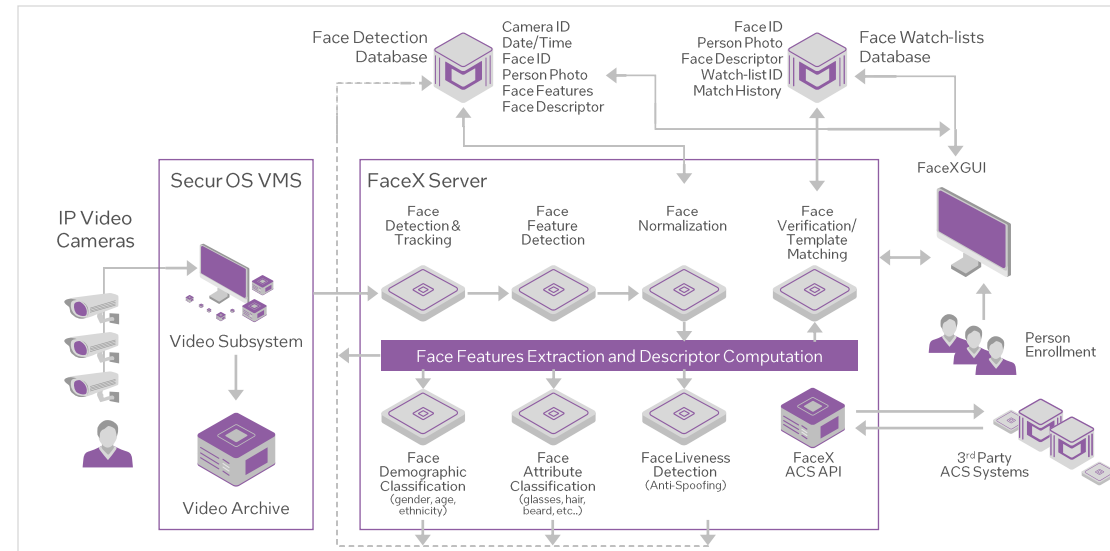

Target Vertical:

Government

Secondary Verticals:

Transportation

Target Use Case:

Situational Monitoring

Secondary Use Case:

Asset & Operations

Optimization. Product

Inspection

Geo Availability

NAR, LAR, APAC, EMEA, and ROW (Not available in China or India)

Learn More

- [ISS Homepage](#)



# Power Efficiency & Electrical Safety Management Solution

## Solution Overview

The InSynerger Power Efficiency & Electrical Safety Management solution is an energy management platform that provides data analysis and 24/7 equipment and energy monitoring to help reduce costs, improve efficiency, increase utilization productivity, provide abnormal utilization alerts, and implement safer energy consumption practices.

## Value Props



Provide easy energy management by remotely tracking and managing the power usage, quality, and stability



Enable high scalability by easily expanding to multiple applications in one platform (e.g. water management, light management, AC management, etc.)



Offer effective power savings by uncovering key factors that contribute to energy waste, helping save up to 10% on annual electricity charges

## Intel Components

- Intel® Core™ i7 Processors
- Intel® Celeron® Processors
- Intel® Xeon® Processors

### Implementation 1: Energy power monitoring

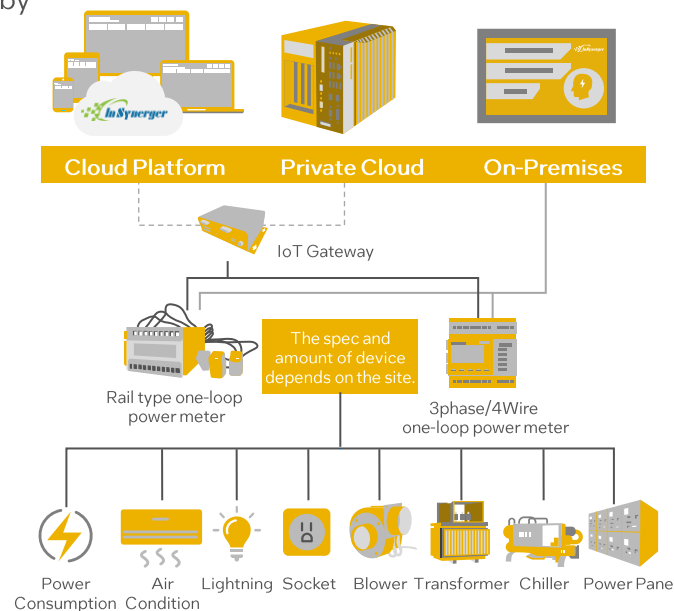

### Implementation 2: Electricity power safety

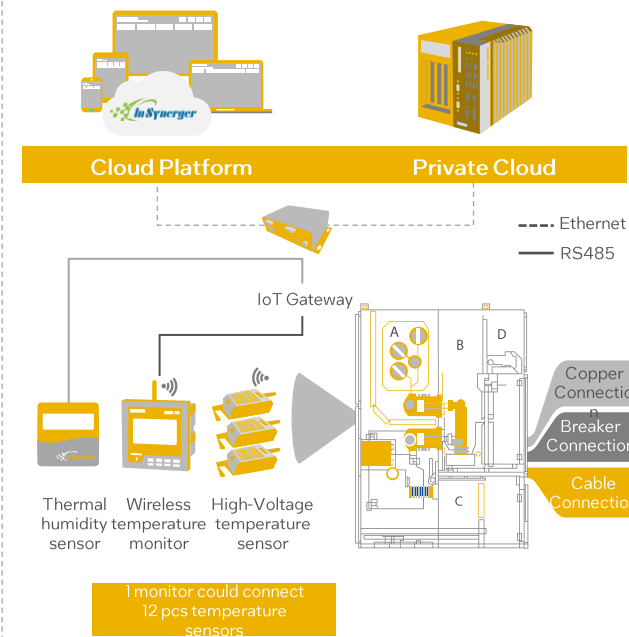

Target Vertical:  
Energy

Secondary Verticals:  
Education

Target Use Case:  
Energy Monitoring & Management

Geo Availability  
Taiwan, Vietnam, and Thailand

### Learn More

- [InSynerger Website](#)
- [Contact InSynerger](#)
- [PowerManagement](#)
- [WPI IoT Solution Aggregator](#)

# iProd MOP Manufacturing Optimisation Platform

## Solution Overview

The iProd MOP solution allows companies to boost the productivity and quality of their business with a disruptive pay-as-you-go business model and free cloud version. As a cutting-edge industrial cloud platform, data from the edge is stored and managed to help manufacturers optimize operations.

## Value Props



**Enhance operational efficiency** with actionable insights from edge devices to support manufacturing decisions extended to the entire supply-chain



**Drive ROI** with IoT monitoring and management from the cloud to increase efficiency along the investment life-cycle



**Deploy systems easily** with plug and play IoT and cloud capabilities to enable remote production and device control

## Intel Components

- Intel® Atom® Processors

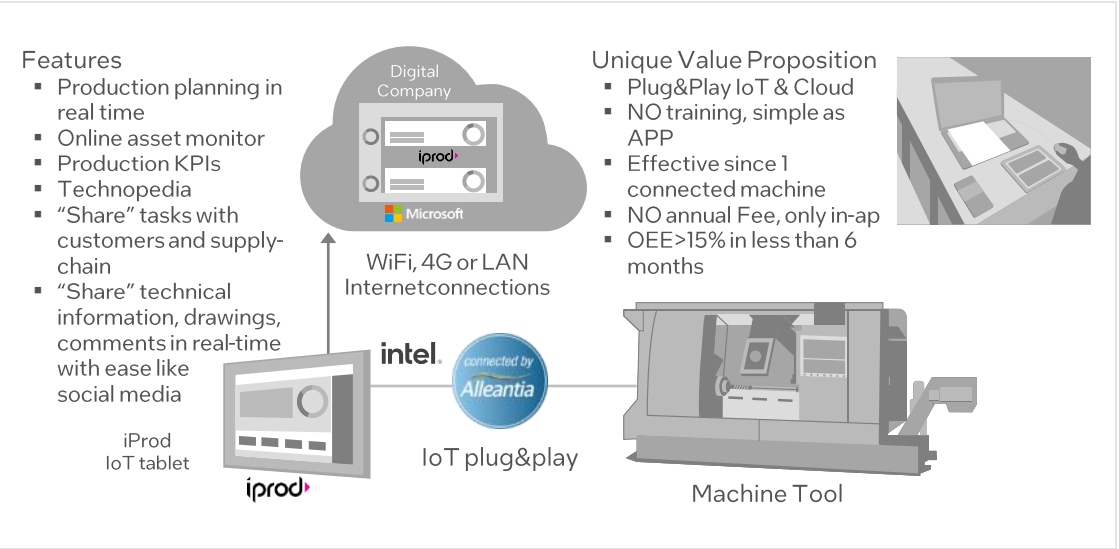

**Target Vertical:**  
Manufacturing

**Secondary Verticals:**  
Banking/Financial Services (flexible leasing rate according to the effective asset utilization)

**Target Use Case:** Asset & Operations Optimization

**Secondary Use Cases:**  
Asset Condition Monitoring, Machine Customer

**Third Use Case:** HR Tracking

## Geo Availability

Available in Italy, Canada, United States, Germany, France, Switzerland, Austria, United Kingdom

**Learn More**

[iProd website](#)



# ISSD Electronics SPECTO™ Incident Detection System

## Solution Overview

The ISSD Electronics SPECTO™ Incident Detection System is a vision based, automatic incident detection system that reduces emergency response times by informing operators of potential dangers in tunnels and on highways. Footage captured via CCTV is translated through ISSD technology to improve traffic security and public safety.

## Value Props



Accelerate emergency response with visual processing units for quick and dependable detection of incidents



Deploy a cost-effective and sustainable solution with flexibility and scalability



Leverage reliable surveillance with trained SPECTO™ CNN algorithms on ISSD collected datasets to track environments of interest for consistent performance

## Intel Components

- Intel® Distribution of OpenVINO™ toolkit
- Intel® Movidius™ Myriad™ VPUs
- Intel® Xeon® Processors

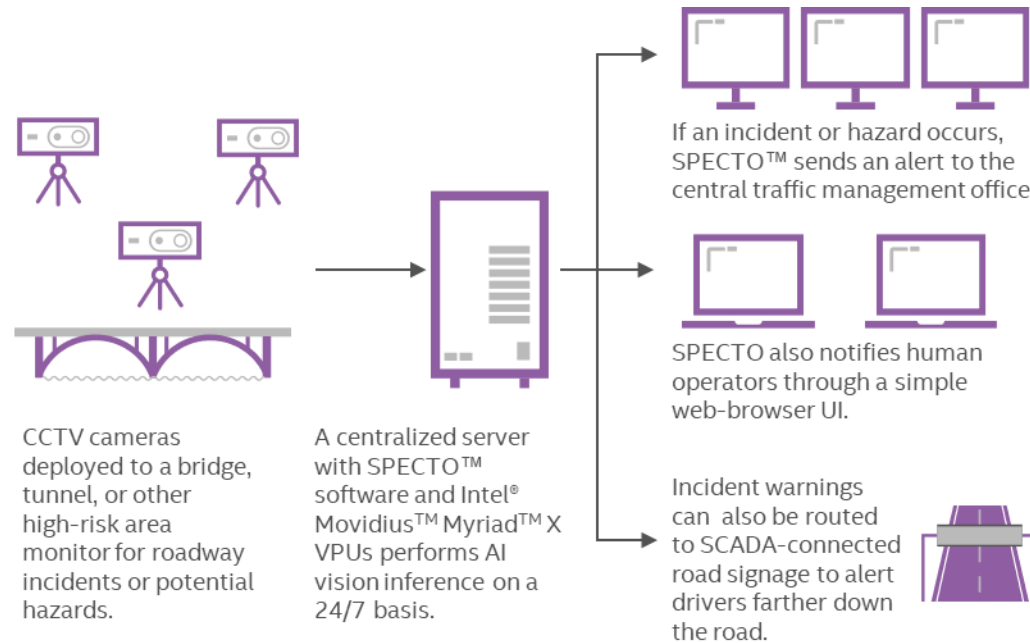

1. "SPECTO™ Automated Tunnel Incident Detection System", ISSD Website, 2020

Target Vertical:  
Government

Secondary Vertical:  
Transportation

Target Use Case:  
Control Optimization &  
Autonomy

Secondary Use Case:  
Environment Monitoring

Geo Availability  
USA, Middle East, North  
Africa, and Europe

## Learn More

- ISSD Website
- ISSD Specto Automated Tunnel Incident Detection System

# JelloX Biotech Inc. MetaLite® Digital Pathology Edge Solution

## Solution Overview

Medical imaging analysis and diagnostics is rapidly changing with the advent of new technologies. As such, practitioners and researchers are looking for solutions that provide the most accurate and reliable data. To meet this demand and ensure professionals have the best medical imaging tools at their disposal, JelloX Biotech Inc. has developed MetaLite®, a Picture Archiving and Communications System (PACS), that can be integrated with many Radiology Information Systems (RIS) or Hospital Information Systems (HIS), to provide practitioners with a scalable, user-friendly, AI-enabled imaging and digital pathology platform. Equipped with high-quality scanners and servers, along with the Intel NUC to connect to additional devices, the solution provides actionable insights, and the AI interface allows for customization through the AI-auxiliary annotation function and other programmable protocols.

## Value Props

- Deploy an affordable low TCO solution that operates without a GPU, and is easily scalable with edge hardware, eliminating many barriers to entry
- Enhance patient care and research quality with a system that provides real-time data to help analyze patient conditions, and equip practitioners with the tools necessary to develop timely and preventative insights
- Empower pathologists, practitioners, and researchers with tools that minimize guesswork, streamline results, and give experts time back to pursue other tasks such as research or patient care

## Kit Components

- Intel® Core™ i5 Processors
- Intel® Xeon® Processors
- Intel® NUC

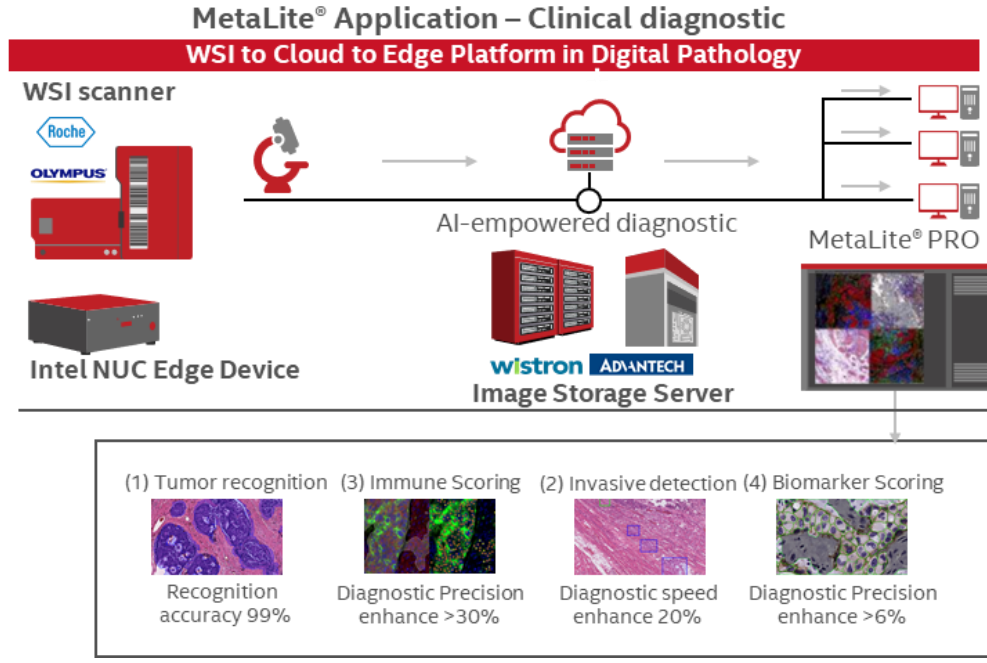

**Target Vertical:**  
[Health & Life Sciences](#)

**Secondary Vertical:**  
[Education](#)

**Target Use Case:**  
[Human Wellness Monitoring](#)

**Geo Availability**  
APJ

**Learn More**

- MataLite® brief [Introduction – YouTube](#)
- [HOME | MetaLite®](#) [Subscribe](#)

# Jovision Technology Smart Community Solution

## Solution Overview

The Jovision Smart Community solution provides efficient, accurate monitoring and management for properties and cities that help increase overall safety and enable seamless experiences via connected devices. The Smart Community solution analyzes and records behaviors, vehicles, events, and the overall environment to better organize and manage a given area.

## Value Props

 **Simplify operations** with new connected devices empowered by one platform that empower a variety of capabilities, such as temperature/environment sensors, cameras, automated access, etc.

 **Create economic opportunities** by optimizing security and overall property management systems to reduce costs and enable more energy efficiency

 **Help increase overall security** for citizens, residents, and/or visitors by providing preventative surveillance, potential incident detection, secure access points, and more

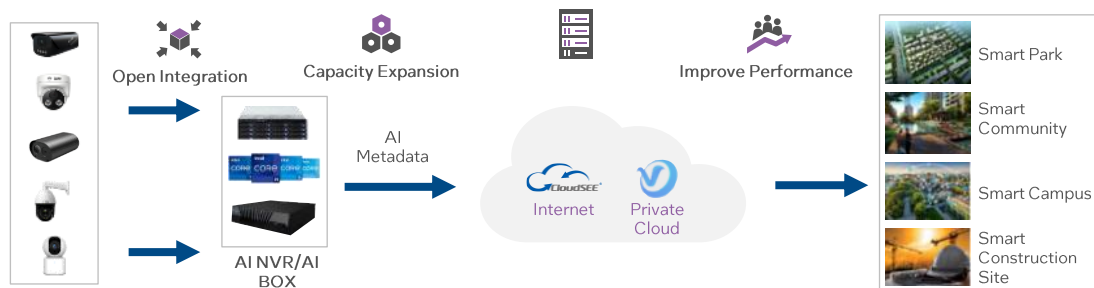

## Intel Components

- Intel® Celeron® Processors
- Intel® Core™ Processors
- Intel® Core™ i3 Processors
- Intel® Xeon® Processors
- Intel® Iris® Xe graphics
- Intel® Distribution of OpenVINO™ toolkit

**Target Vertical:**  
Government, AI/SI  
 Companies

**Secondary Vertical:**  
Retail, Smart Community  
 Technology

**Target Use Case:**  
Situational Monitoring

**Geo Availability**  
 Asia, Pacific, and Japan,  
 Americas, Europe, Middle  
 East and Africa, People's  
 Republic of China

**Learn More**  
[Jovision Website](#)



# JWIPC iLearn Remote Class Interactive

## Solution Overview

The JWIPC iLearn Interactive Remote Class Solution, powered by Intel, meets the demand for high quality, online education with an efficient, flexible, and reliable interactive video solution

Target Vertical: Education

Target Use Case: Interactive Media

Geo Availability  
China, SE Asia, EMEA, APAC, and the Americas

### Learn More

- [JWIPC Website](#)
- [JWIPC iLearn Remote Class Interactive Solution Webpage](#)

## Value Props

 Enhance classroom experiences with interactive learning environments that improve student outcomes

 Expand learning opportunities by empowering learning any time, anywhere and reach more students

 Ease administrative burden with simplified solution management that optimizes teaching time

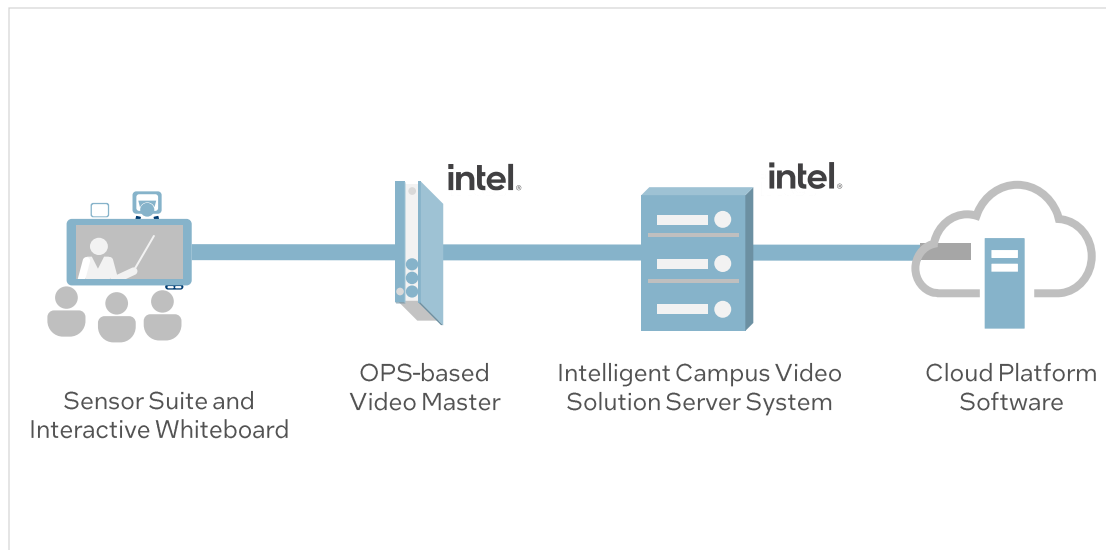

## Intel Components

- LG1151 slot Intel® Core™ processor
- Intelligent Campus Video Solution Server System
- Intel® Xeon® E3-E5-based edge server

# Jian24 Smart Retail Solution

## Solution Overview

The Jian24 Smart Retail Solution is a GDPR compliant IoT smart inventory tracking, and checkout system enabled with “Open by Face” and “Take and Go” protocols. This solution is fully automated, self-training, and comes with a range of inventory management capabilities.

## Value Props



**Improve ground operations** by using an innovative collaboration suite that improves efficiency, mitigates errors, and help create better travel experiences



**Maintain constant situational awareness** through an airport monitoring solution that helps manage cybersecurity along with traveler and employee safety



**Increases aircraft turnaround efficiency** by synchronizing databases and live data from the edge through a rapid protocol management system

## Intel Components

- Intel® Distribution of OpenVINO™ toolkit
- Intel® Core™ i7 Processors
- Intel® Iris® Graphics

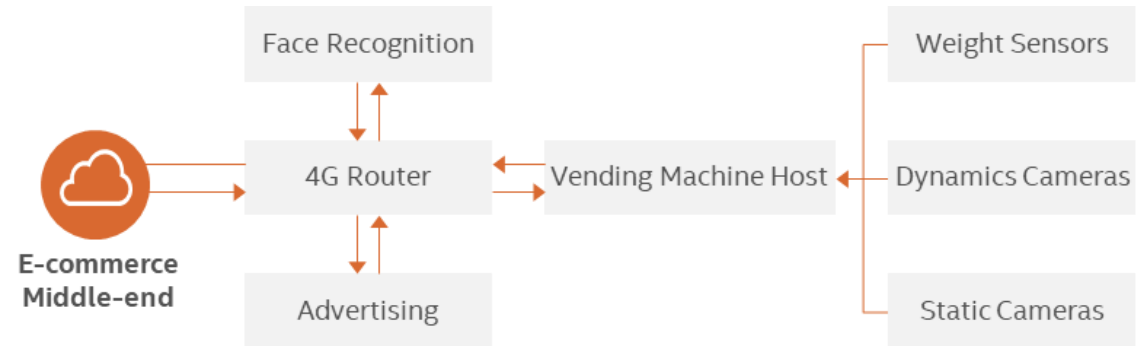

**Target Vertical:**  
Retail

**Secondary Verticals:**  
Health & Life Sciences;  
Manufacturing; Industrial

**Target Use Case:**  
Asset & Operations  
Optimization

**Secondary Use Case:**  
Logistics & Tracking; Product  
Inspection; Situational  
Monitoring

**Geo Availability**  
Peoples Republic of China,  
Japan

### Learn More

- [Jian24 Website](#)
- [Jian24 CEO Tells The Company's Story](#)
- [Jian24 Deployment in China](#)



# LACHESIS Mhealth 5G Smart Ward Solution

## Solution Overview

LACHESIS Mhealth 5G Smart Ward Total Solution, is a Clinical Management Information System (CMIS) that combines 5G, IoT, AI, smart terminals, and information management to provide hospitals with an end-to-cloud suite of mechanical and digital tools to manage a patient's journey from treatment to discharge.

## Value Props



**Enhance patient care** with a system that uses real-time data to monitor an individual's condition, predict changes, and issue early warnings



**Optimize staff efficiency** through remote and unmanned solutions that synchronize pipelines, reduce workloads, and minimize medical risks



**Strengthen medical safety protocols** with a range of hardware capable of managing pharmaceutical dispensation, medical supplies, and remote consultations

## Intel Components

- Intel® Core™ i7 Processors
- Intel® Core™ i5 Processors

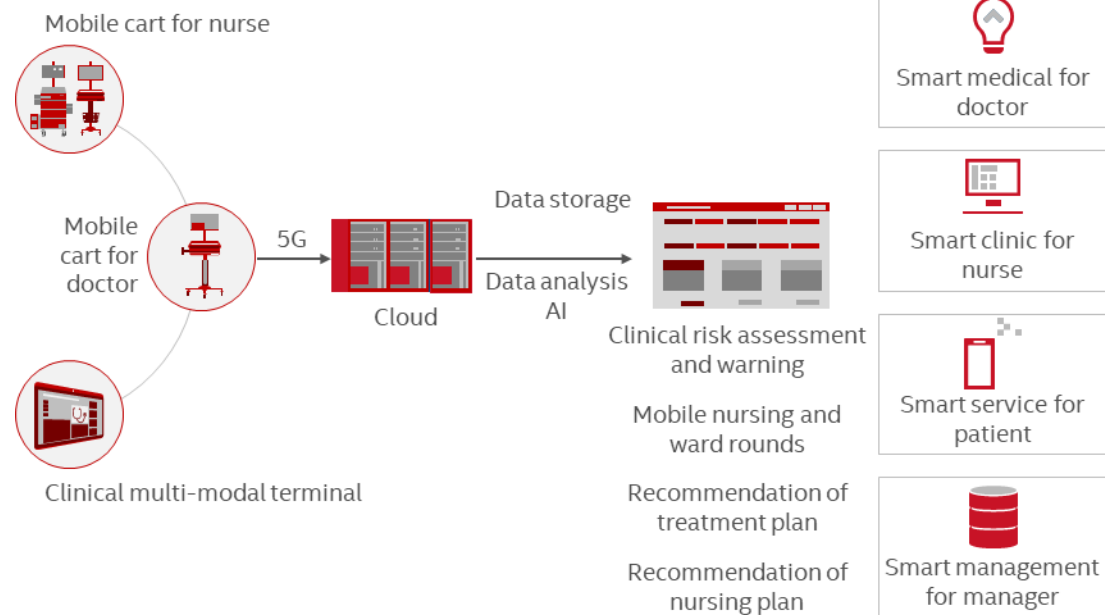

**Target Vertical:**  
Health & Life Sciences

**Target Use Case:**  
Human Wellness & Monitoring

**Geo Availability**  
People's Republic of China

**Learn More**

- [Smart Ward Solution](#)
- [Smart Ward Interaction Platforms](#)





# LG-MRI BoldVu® Kiosks

## Solution Overview

A turnkey outdoor digital signage solutions engineered to provide unparalleled visual performance and longevity in public spaces.

## Value Props

 **Deliver unsurpassed visual performance** with 3500 nits luminance, high contrast, and full color gamut on each screen

 **Reduce total cost of ownership** by efficiently deploying a turnkey solution with a 10-year life-cycle and near-zero maintenance

 **Customize solution capabilities** with a modular platform that easily integrates a myriad of hardware components

## Intel Components

- Intel® Core™ vPro™- enabled Intel® NUC Boards

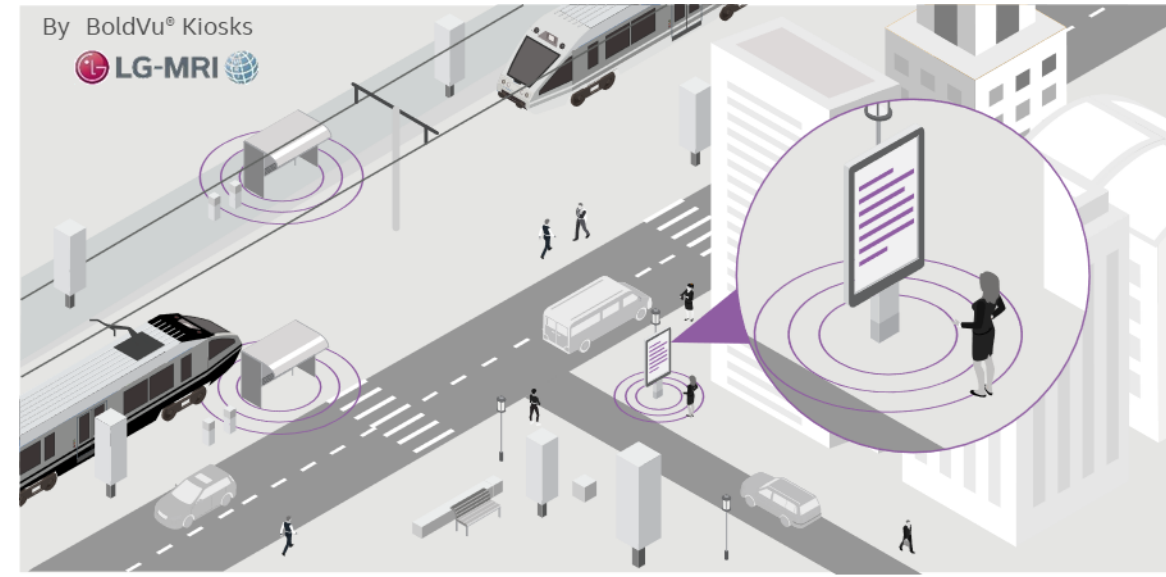

**Target Vertical:**  
Government

**Secondary Vertical:**  
Mixed Use Retail, Outdoor Media

**Target Use Case:**  
Interactive Media

**Secondary Use Case:**  
Advertising, Wayfinding

**Geo Availability**  
North America, South America, Europe, Middle East, Africa, and Asia

**Learn More**  
LG-MRI Website



Back to Retail Solutions

Back to Interactive Media Use Cases



# M3T Retail Kiosk

## Solution Overview

A retail kiosk solution designed to enhance the customer experience by providing an in-store terminal to assist in locating items, checking inventory status, purchasing, pick-up/shipping, and completing the transaction.

## Value Props

Enhance end user experience with simplified navigation screens and layout

Increase efficiency through advanced cash access processing

Drive revenue through easy-to-access credit card transactions

## Intel Components

Intel® Core™ i5

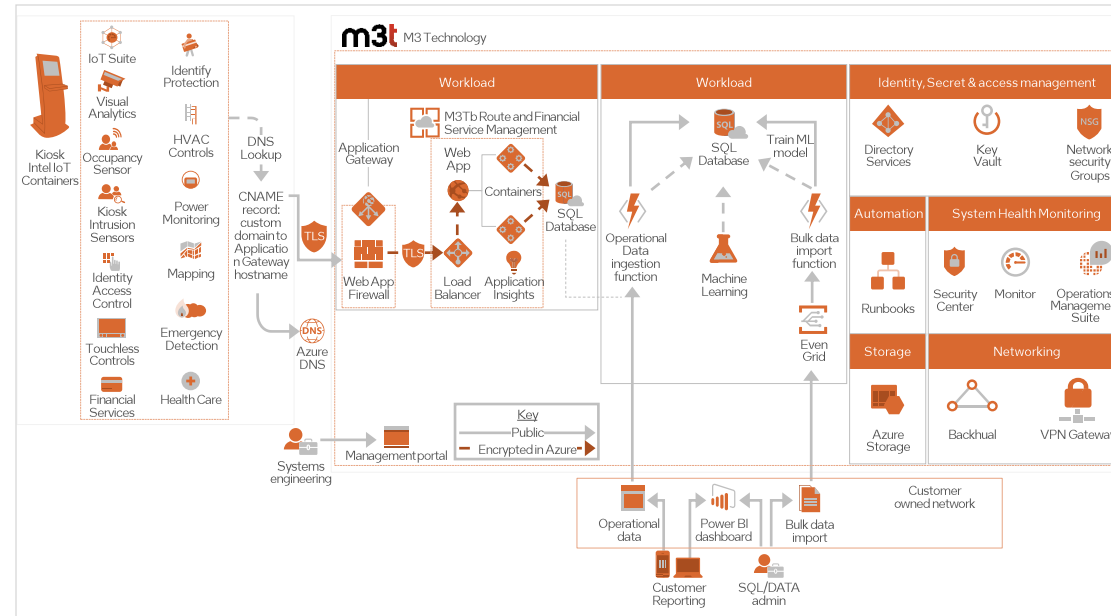

Target Vertical: Retail

Secondary Verticals: Banking/Financial Services, Hospitality

Target Use Case: Interactive Media

Secondary Use Case: Logistics & Tracking

Geo Availability

Available in USA

Learn More

- [M3t Website](#)
- [M3t Financial Services Website](#)

# Mashgin Touchless Checkout System

## Solution Overview

The Mashgin Touchless Checkout System is a self-checkout solution designed to instantly identify products and swiftly complete transactions – speeding up checkout times by as much as 400%. Equipped with a camera array, this system uses computer vision to ring up items rather than barcodes, allowing it to ring multiple items at once without any effort from customers. Shoppers simply place their items on Mashgin’s tray and can immediately pay. This dramatically increases customer thrupt, reducing queues and generating more sales for retailers while providing customers with positive and efficient checkout experiences.

## Value Props

- Maximize sales volume** with a system proven to increase sales by 20% - 300% through rapid identification technology that increases customer thrupt<sup>1</sup>
- Reprioritize labor and reduce overtime** through a tool that can save 30 – 100 hours per week and provides staff the flexibility to focus on high-priority tasks
- Create positive customer experiences** by lowering average checkout times to 10-22 seconds and dramatically decreases lines

## Kit Components

- Intel® Core™ i5 Processors



**Target Vertical:**  
Retail

**Secondary Vertical:**  
Hospitality

**Target Use Case:**  
Product Inspection, Asset Operations and Optimization, Self-Checkout, Autonomous Checkout

**Geo Availability**  
United States, United Kingdom, Canada, Sweden

- Learn More**
- [Mashgin Demo – Product Video](#)
  - [Mashgin | Simple. Easy. Checkout.](#)

<sup>1</sup>. Internal statistic, Mashgin 2021

# Matrox Imaging Manufacturing Machine Vision Solution

## Solution Overview

Allow users to intelligently inspect products as they go through the manufacturing process. Easily configure and deploy the system with compact and capable hardware like a smart camera and vision controller and leverage easy-to-use imaging software.

## Value Props



Configure manufacturing systems with a flexible system that can be quickly catered to requirements and deployed



Improve production quality and lower costs with a reliable solution that can gather information and communicate with existing equipment

## Intel Components

- Intel® Celeron® Processors
- Intel® Core™ i5
- Intel® HD graphics 630

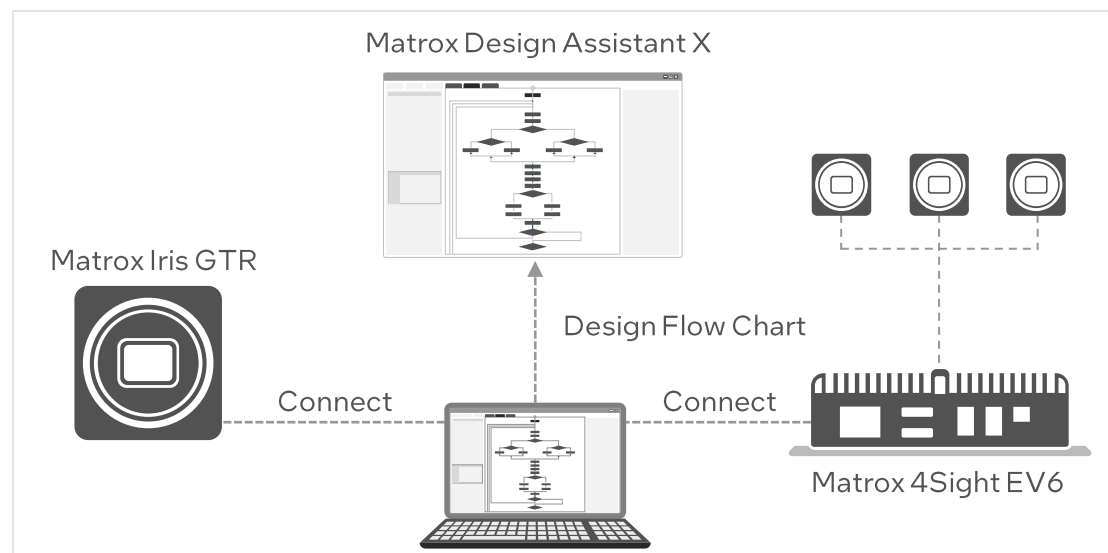

Target Vertical: [Manufacturing](#)

Secondary Vertical: [Energy](#)

Target Use Case: [Product Inspection](#)

Secondary Use Cases: [Logistics & Tracking](#), [Interactive Media](#), [Situational Monitoring](#), [Control Optimization & Autonomy](#)

Geo Availability

Available globally

Learn More

- [Matrox Imaging website](#)



# Medigate Device Security Platform Powered by Dell and VMWare

## Solution Overview

The Medigate Device Security Platform is an end-to-end healthcare-specific IoT and IoMT cybersecurity solution with VMWare and Dell technologies. Medigate’s understanding of clinical workflows and medical devices helps healthcare systems detect anomalies and protect clinical information.

## Value Props



Help protect healthcare systems with a deep understanding of workflows and medical devices to monitor potential risks



Operationalize data insights by sending commands to align workflows and enable automation for security functionality



Deploy an end-to-end solution with data collection across networks to detect device utilization and perform threat assessments

## Intel Components

- Intel® Xeon® Processors
- 10gbe Intel® ethernet network adapters
- Intel® Solid State Drives (SSD)

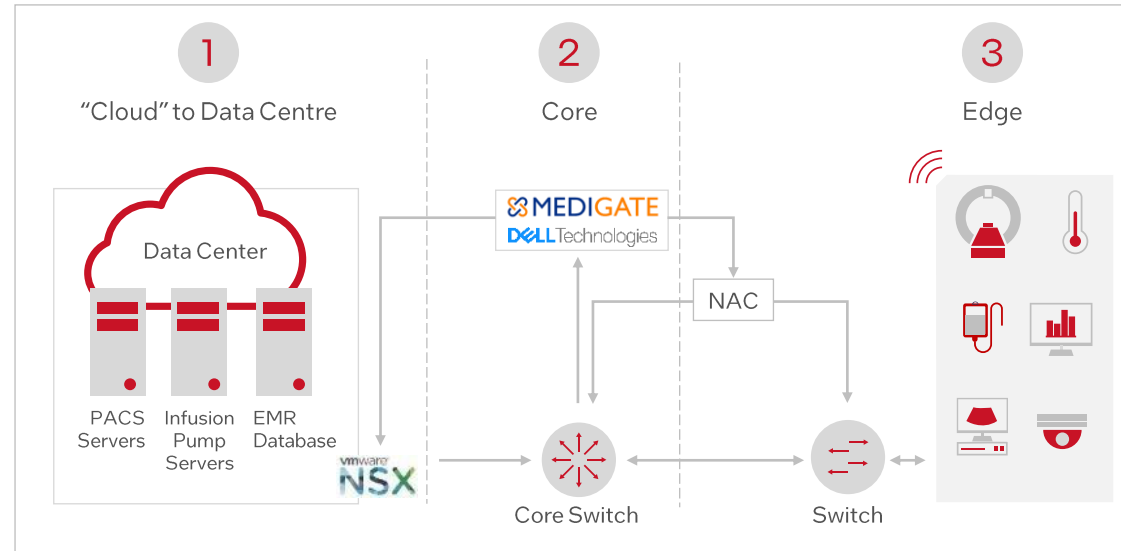

**Target Vertical:** Health & Life Sciences

**Target Use Case:** Asset & Operations Optimization

## Geo Availability

Brazil, Canada, Mexico, United States, Australia/New Zealand, India, Japan, South Korea, Germany, Israel, Middle East, North Africa and Turkey, UK, Other Americas

## Learn More

- [Medigate Website](#)
- [Medigate – A Clinical Use-Case Driven Approach to a Comprehensive Cybersecurity Program Development](#)



# MegAAOI Spring Probe AOI Machine

## Solution Overview

The MegAAOI Spring Probe AOI Machine for IC test socket utilizes artificial intelligence and deep learning to completely automate the spring probe inspection process to help manufacturers streamline operations and ensure output while keeping costs minimal. The MegAAOI solution uses AIoT-based deep learning to inspect probes based on customer's unique parameters to automate the inspection process while keeping inspection quality high.

## Value Props



Increase throughput of spring probes with a solution that uses AI for product inspection for a higher rate of throughput while maintaining accuracy.



Reduce the burden of labor by implementing a solution that eliminates manual inspection and inspector training while freeing up staff for other tasks



Increase revenue with a machine that increases spring probe output and reduces labor costs for more efficient operations.

## Kit Components

- Intel® Distribution of OpenVINO™ Toolkit
- Intel® NUC
- Intel® Xeon® Processors
- Intel® Core™ i7 Processors

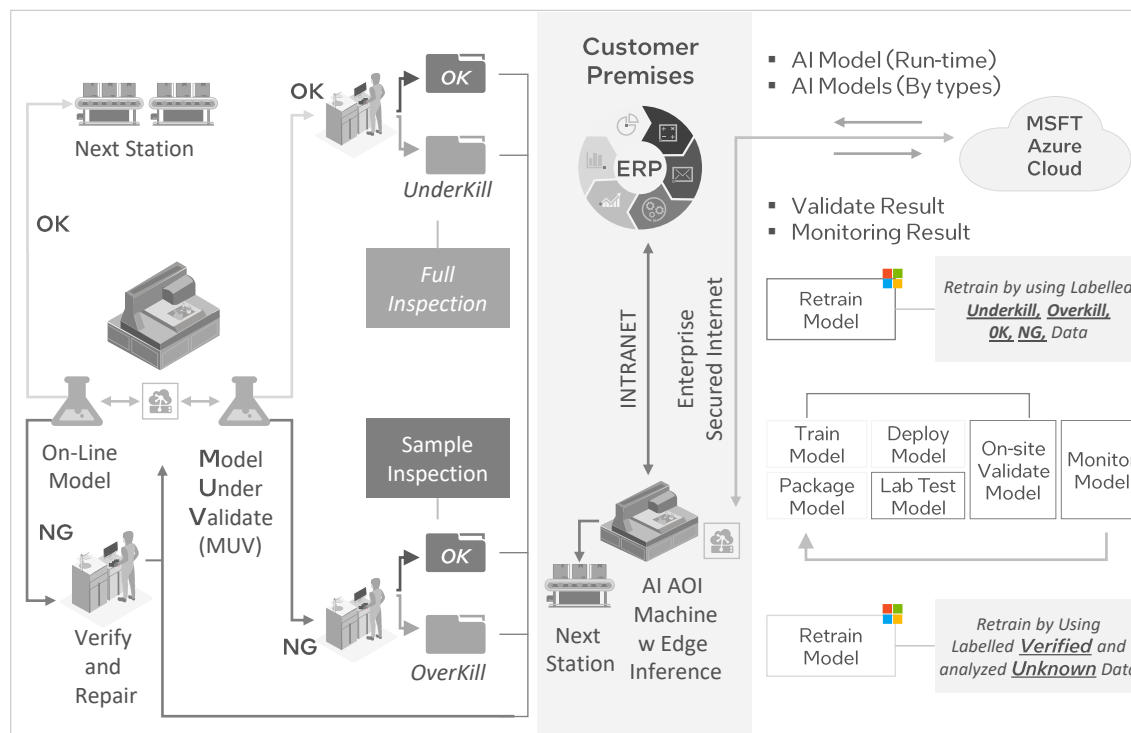

Target Vertical:  
Manufacturing

Secondary Vertical:  
Health & Life Sciences

Target Use Case:  
Product Inspection

Geo Availability  
APJ

## Learn More

- [MegAAOI Website](#)
- [MegAAOI Spring Probe AOI Machine Video](#)

# Megh Computing, Inc. VAS for Smart Buildings

## Solution Overview

Megh's VAS (Video Analytics Solution) for Smart Buildings provides situational monitoring of people and assets in any venue including office buildings, retail establishments, multi-family complexes, and industrial sites. It reduces physical risks and improves operational efficiencies delivering value to operators of the venues. The solution supports use cases such as loiter detection, intrusion detection, people occupancy, people tracking, vehicle tracking, etc. out of the box. Custom use cases can also be developed and deployed as needed on Megh's VAS platform. The platform supports CPUs, GPUs, FPGAs, or SOCs for AI+ acceleration to deliver lower TCO from the edge to cloud.

## Value Props

- Manage occupancy** optimally with existing security infrastructure that reports on people and objects count, queues, wait times, and more, with formatting and visualization tools
- Improve safety of people and assets** with situational awareness that triggers rule-based action for suspicious behaviors, security threats, and emergencies
- Drive operational efficiencies** by monitoring on-site business processes to improve overall performance and policy compliance without additional personnel

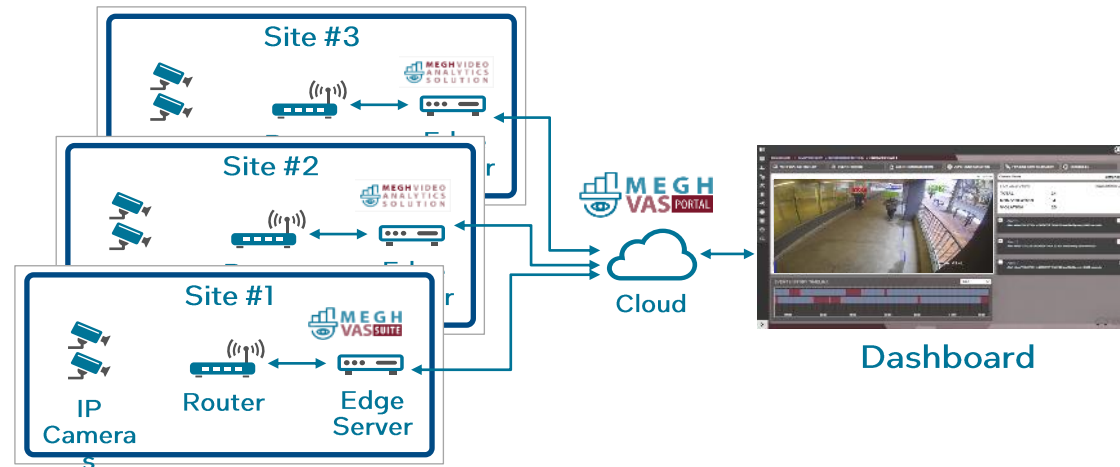

## Intel Components

- Intel® Core™ i3 Processors
- Intel® Core™ i5 Processors
- Intel® Core™ i7 Processors
- Intel® Core™ i9 Processors
- Intel® Xeon® Processors
- Intel® NUC
- Intel® Server GPU
- Intel® FPGAs
- Intel® Distribution of OpenVINO™ toolkit
- Intel Sonoma Creek AI Workflow Platform

## Target Vertical:

Retail, Commercial Real Estate

## Secondary Vertical:

Manufacturing, Transportation, Warehousing

## Target Use Case:

Situational Monitoring

## Secondary Use Cases:

Asset & Operations Optimization, Human Wellness Monitoring

## Geo Availability

Asia, APAC, Americas, Europe, Middle East, and Africa

## Learn More

- [Megh Computing Home](#)
- [Megh Computing Documentation](#)

# Microvision Machine Vision Kit for Smart Manufacturing

## Solution Overview

The Microvision Machine Vision Kit for Smart Manufacturing provides a customizable solution for end customers that automates product inspection across manufacturing use cases including visual inspection, optical measurement, visual equipment, visual localization, and visual identity.

## Value Props



Increase production efficiency with an end-to-end machine vision solution that automates product inspection



Choose a proven solution with more than 1,000 customers and more than 3,000 application scenarios



Gain scalability with a solution that has all the software and hardware components required to address end customer problems regardless of size

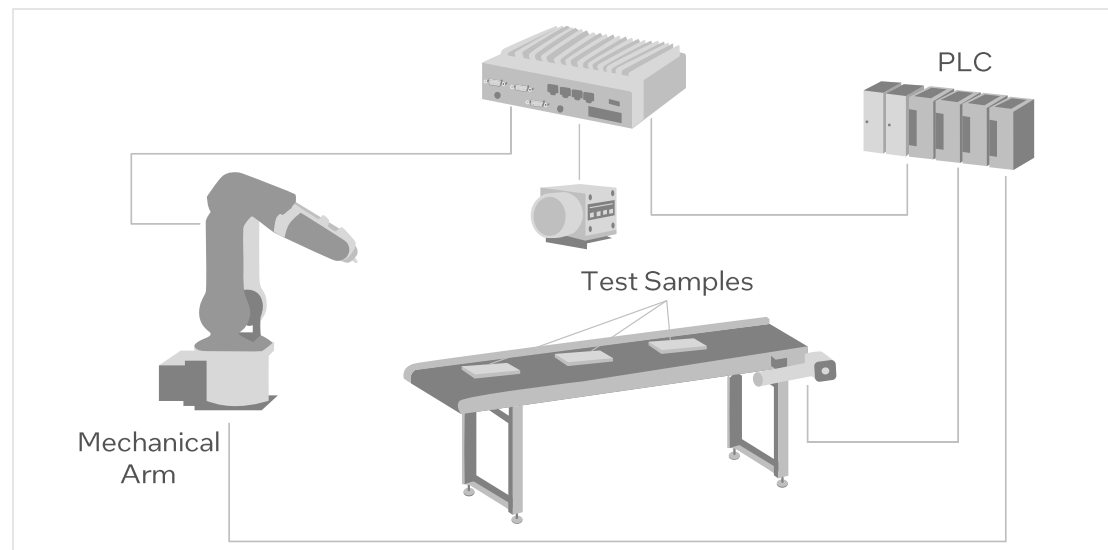

## Intel Components

- Intel® Core™ i7 Processor
- Intel® Distribution of OpenVINO™ Toolkit
- Intel® FPGA

Target Vertical: [Manufacturing](#)

Secondary Verticals: [Education](#)

Target Use Case: [Product Inspection](#)

Secondary Use Cases: [Machine Condition Monitoring](#); [Situational Monitoring](#)

Geo Availability  
Available in PRC

[Learn More](#)  
[Microvision website](#)





# MIC's Sickbay™ Platform

Back to Health & Life Sciences Solutions

Back to Human Wellness Monitoring Use Cases



## Solution Overview

Sickbay is an FDA-cleared Clinical Platform enabling data driven medicine. The platform continuously captures time-series waveform data from any medical device as well as other system data and transforms that data into web-based clinical apps to enable virtual care and the development and deployment of real-time AI so care teams can make better, faster decisions.

## Value Props

- Improve patient care** by enabling flexible, vendor neutral remote monitoring across all service lines
- Increase operational efficiency** by displaying real-time and unlimited historical, second by second, waveform data across devices in a single view
- Streamline transitions of care** through access to full resolution full disclosure data
- Get ahead of deterioration and risk** by developing and deploying real-time, patient centric AI back into clinical care

## Intel Components

- Sick bay platform and web-based apps
- PowerEdge® FX and Rack Servers
- Intel® Xeon® Processors
- Solid State Drives
- BigDL

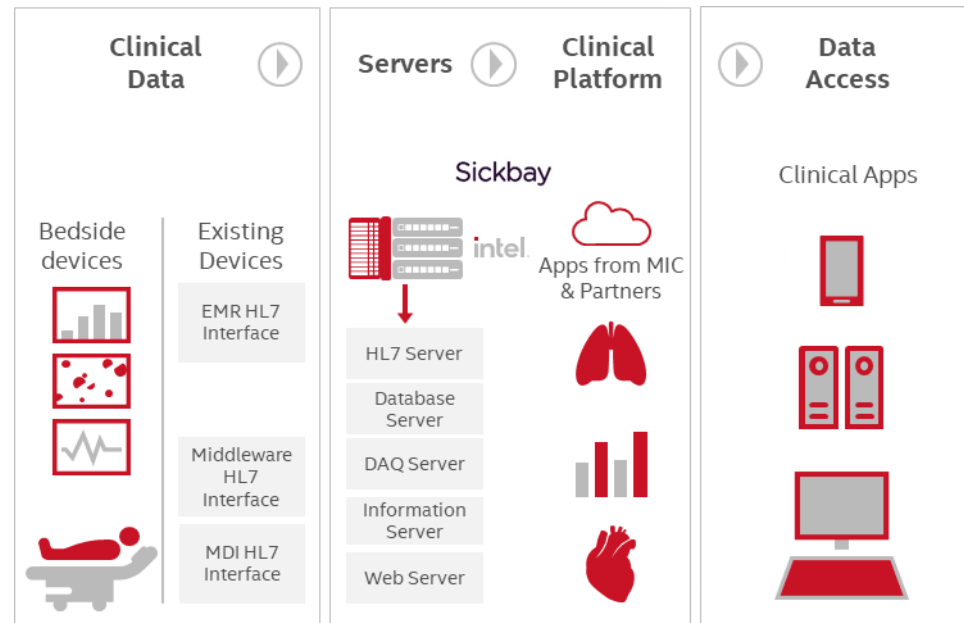

Target Vertical:  
Health & Life Sciences

Target Use Case:  
Human Wellness Monitoring

Geo Availability  
United States

### Learn More

- [Houston Methodist vICU video](#)
- [Houston Methodist CIO, Ken Letkeman, discussing expanding virtual care into other service line](#)
- [Healthcare Data Matters webinar replays and video clips](#)
- [MIC home page](#)
- [UAB Medicine Video](#)



# Mingtech Intelligent Medical Payment Platform

## Solution Overview

The Mingtech Intelligent Medical Payment Platform System is an intelligent cloud service platform for medical institutions. Through the application of facial recognition, blockchain, and other technologies, the service platform scheme can verify and supervise the identity of medical patients, to ensure the safe use of medical insurance funds, and simplify the system's medical treatment process.

## Value Props



Achieve better information sharing by facilitating communication between multiple healthcare organizations



Improve operational efficiencies by accessing patient data and billing from one location



Reduce time to receive payments with streamlined billing that lowers time to queue payment

## Intel Components

- Intel® Core™ i3 processors
- Intel® Core™ i5 processors
- Intel® Distribution of OpenVINO™ Toolkit

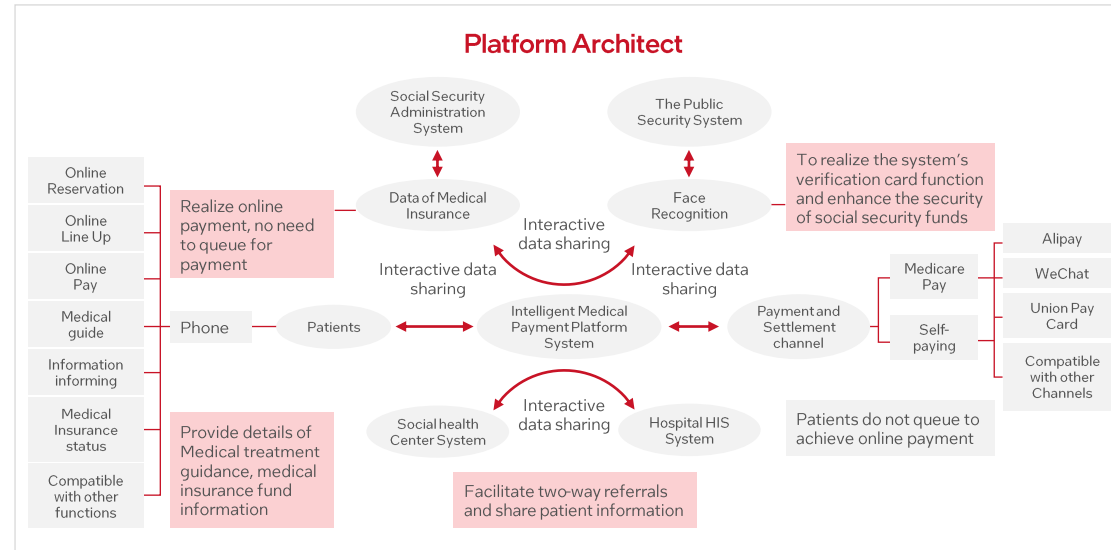

Target Vertical: Health & Life Sciences

Target Use Case: Interactive Media

Geo Availability PRC

Learn More Mingtech website

# MiTAC Machine Vision in Factory Automation

## Solution Overview

Today's manufacturing facilities are consistently adopting Industry 4.0 machines that can intelligently communicate with each other and perform complex tasks with a collective goal to help carry out safer, faster, and more reliable assembly processes. MiTAC's Machine Vision application integrates embedded computing systems and smart management systems together, utilizing existing cameras for product inspection. This consolidation of systems enable manufacturers to perform inspection processes with enhanced precision and speed. Additionally, the solution helps supervisors remain vigilant of quality control by collecting real-time visual data for analysis on a centralized user interface. The solution's AI Machine Vision software, INFINITY, offers immense flexibility and caters to a wide range of inspection use cases—such as barcode reading, color inspection, and label inspection.

## Value Props



**Reduce deployment expenses** with a drag-and-drop software visual tool to simplify the deployment for each filed case you own; Plug-and-play hardware modular I/O to ease any connectivity trouble in different filed applications.



**Increase production output** with the integration of vision software algorithms that help manufacturers inspect products for specific characteristics automatically, and with a high level of accuracy



**Help ensure a continuous flow of operations** by collecting real-time visual data of assets for management and analysis to reduce excess material waste and energy usage with precise quality control in the assembly process

## Intel Components

- Intel® Core™ i7 Processors
- Intel® Core™ i5 Processors
- Intel® Core™ i3 Processors
- Intel® Xeon® D Processor

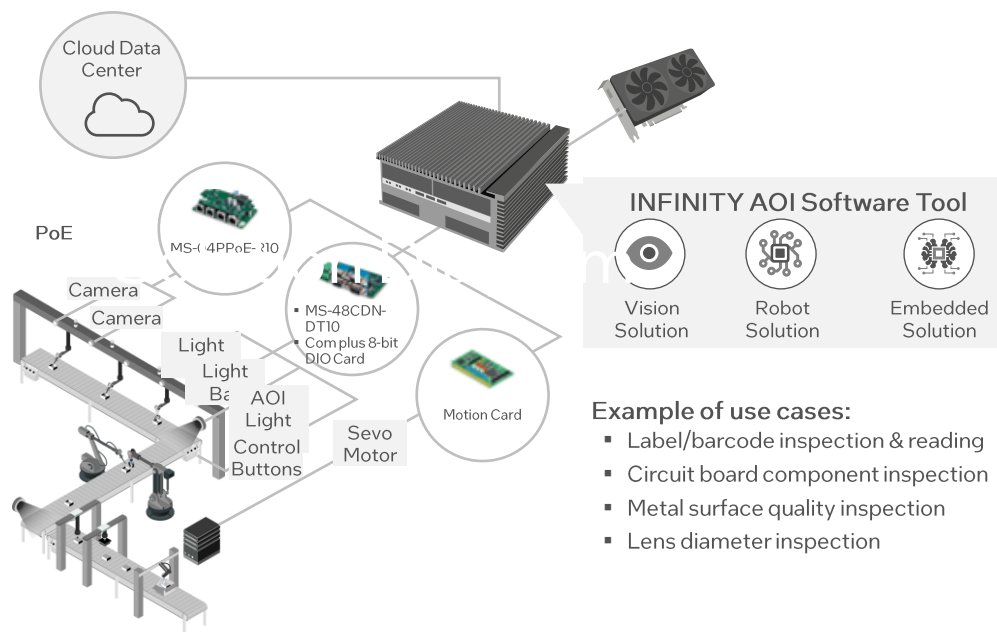

### Example of use cases:

- Label/barcode inspection & reading
- Circuit board component inspection
- Metal surface quality inspection
- Lens diameter inspection

**Target Vertical:**  
Manufacturing

**Secondary Verticals:**  
Retail, Transportation and Warehousing

**Target Use Case:**  
Product Inspection

**Additional Use Cases:**  
Control Optimization & Autonomy, Product Inspection

### Geo Availability

APJ, Americas, Europe, Middle East, and Africa

### Learn More

- [MiTAC Factory Automation Homepage](#)
- [Machine Vision White Paper](#)
- [Machine Vision - YouTube Video](#)



# MITIS Health Lossless Remote Radiology & Pathology Home Reporting

## Solution Overview

MITIS Health Lossless Remote Radiology and Pathology Home Reporting solution allows clinicians to remotely and securely access information about their patients from hospital without the need to move ANY patient data. The solution enables access of all current and previous scan and patient information from PACS/RIS servers to endpoints thousands of miles away, with zero degradation of image quality.

## Value Props



**Optimize information management** with easy to access streaming of hospital desktops and all required applications including PACS/RIS without compromising quality, speed, or security



**Improve work efficiency** by 20-25%<sup>1</sup> achieved without the need to transfer medical data, such as large high-quality DICOM datasets which are streamed across vast distances



**Improve patient experiences** and provide better quality of care at a swifter pace by decreasing time needed for accurate imaging interpretation

## Intel Components

- Intel® vPro® Platform
  - Intel® Xeon® Processors
  - Intel® Server GPU
  - Intel® X550 Dual Port 10GbE Base-T Adapter
  - Intel® NUC
1. Internal Assessment – MITIS Health

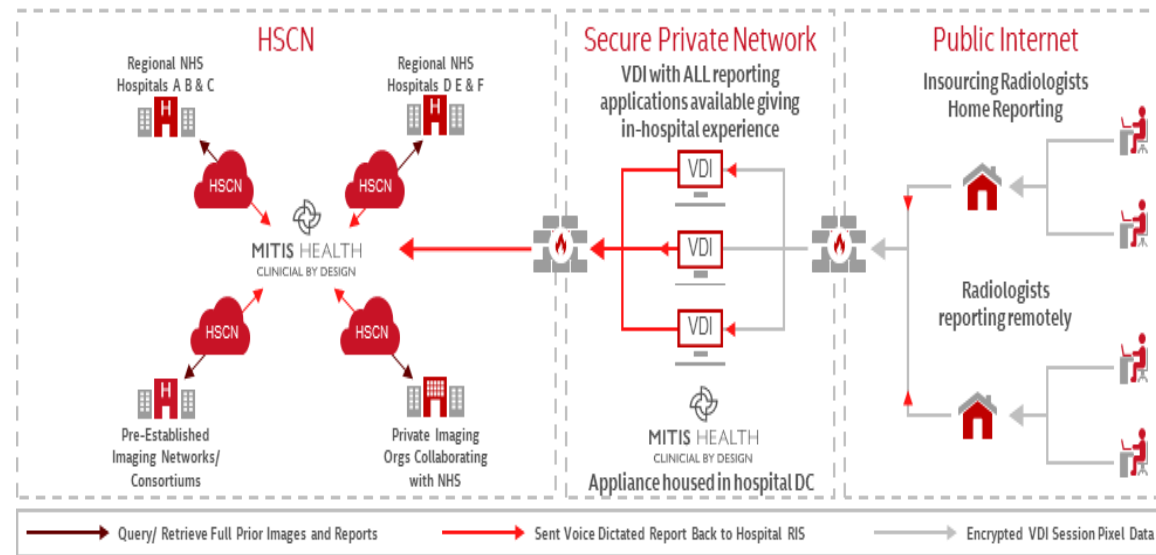

**Target Vertical:**  
Health and Life Sciences

**Secondary Vertical:**  
Energy

**Target Use Case:**  
Human Wellness Monitoring

**Geo Availability**  
Americas, Europe, Middle East, and Africa

## Learn More

- [MITIS Health Website](#)
- [What is the MITIS Health Solution?](#)
- [MITIS VDI – Clinical Virtual Desktops](#)



# Women Safety Solution

## Solution Overview

The Mirasys Women Safety Solution is an artificial intelligence-based video analytics solution that addresses crime-related incidents targeting women by enabling critical analyses of safety for women in public spaces, campuses, etc. The system uses advanced analytics of security footage that captures and classifies images based on gender to better understand how to protect women from incidents in public areas. The system can monitor women who are traveling alone or near a potential threat and/or weapon. Key features include intruder detection, people counting, panic alarms, audio monitoring, system thinking, and video analytics that serve to optimize security operations for businesses and organizations.

## Value Props

- Reduce crime-related incidents against women** with 24/7 automated alerts for weapons, women traveling alone, and other vulnerabilities and threats.
- Scale quickly and easily** with fully-integrated solution that aligns with current camera systems
- Provide Real-time Incident Reporting & Action** through gesture recognition pre-incident identification, which trigger alerts to security teams thus reducing incident action response time and SOP management

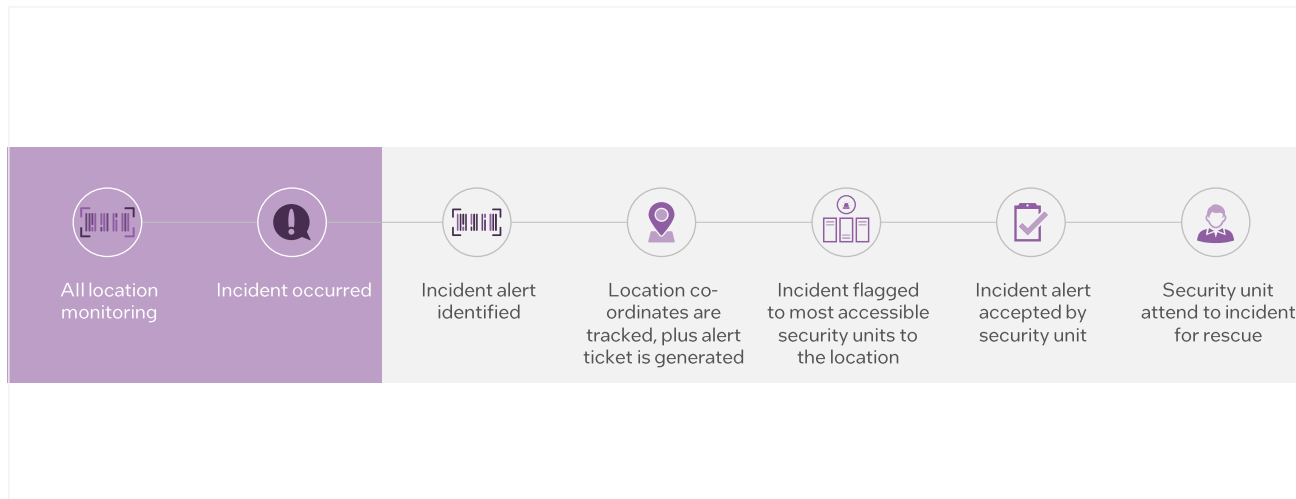

**Target Vertical:**  
[Government](#)

**Secondary Vertical:**  
[Banking/Financial Services](#);  
[Education](#); [Energy](#); [Health & Life Sciences](#); [Hospitality](#);  
[Manufacturing](#); [Retail](#);  
[Transportation](#), [Public Safety](#)

**Target Use Case:**  
[Situational Monitoring](#)

**Geo Availability**  
India; Brazil; Canada; Mexico; United States; Other Americas; Australia/New Zealand; Japan; South Korea; People's Republic of China; Taiwan; Germany; Israel; Middle East, North Africa and Turkey; Russia; Sub-Saharan Africa; United Kingdom

## Kit Components

- Intel® Distribution of OpenVINO™ Toolkit
- Intel® Xeon® Silver Processors
- Intel® Vision Accelerator Design With Intel® Movidius™ VPU
- Intel® Core™ Processors
- Intel® Xeon® Gold Processors

### Learn More

- [www.Mirasysindia.com](http://www.Mirasysindia.com)

# MVISIA Desenvolvidores Inovadores S.A

## MVISIA WEG CVU

### Solution Overview

The MVISIA WEG CVU solution provides an edge compute processing system designed for computer vision and artificial intelligence applications on industrial production lines. The solution enables real-time quality control, part measurement, counting, and other analysis options and is applicable to several manufacturing segments such as automobile, food, cosmetics, mining, etc.

### Value Props

- Increase efficiency and reliability** in the production process with robust vision hardware optimized for industrial applications and built-in security features
- Improve quality control** with a top image processing solution that enables more precision for inspection and automation tasks with special SW and digital cameras
- Support diverse deployments** with a solution that flexible configuration to meet specific usage requirements and various industry scenarios

### Intel Components

- Intel® Celeron® processors
- Intel® Atom® processors

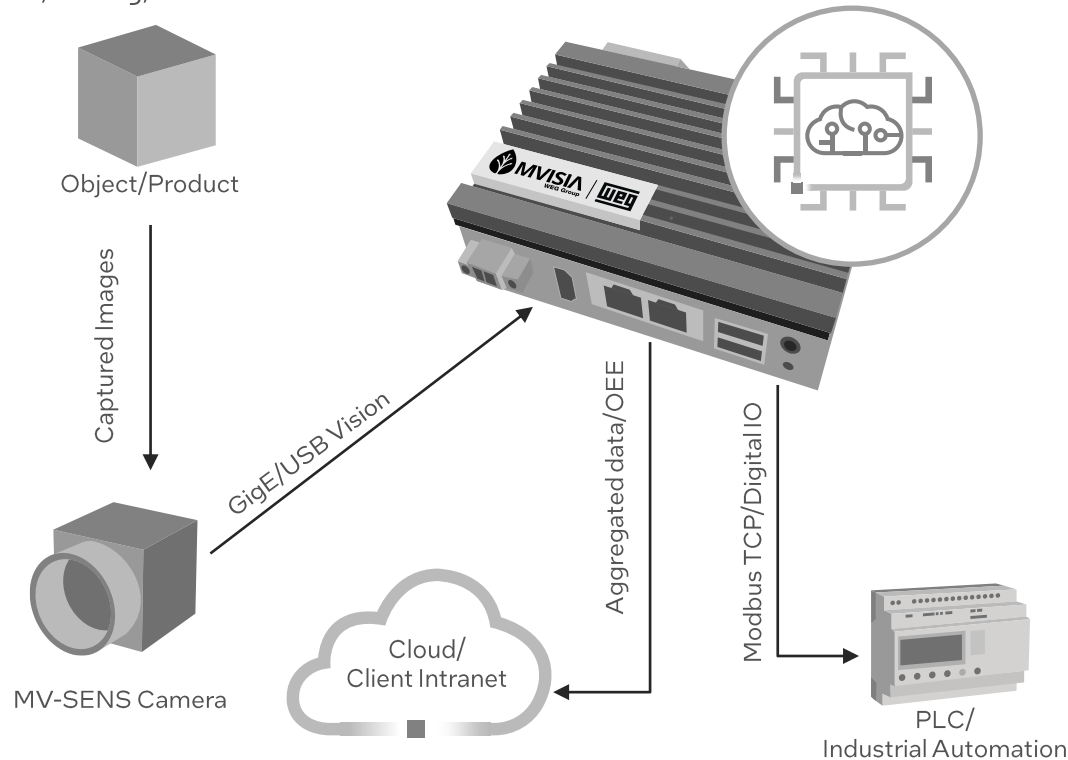

**Target Vertical:**  
Manufacturing

**Secondary Vertical:**  
Agriculture

**Target Use Case:**  
Product Inspection

**Secondary Use Case:**  
Situational Monitoring

**Geo Availability**  
Americas

### Learn More

- [Product Page](#)
- [Case Study](#)



# Nanjing Mythware Information Technology Mythware Smart Classroom

## Solution Overview

The solution makes Internet of Everything a reality by combining classroom management software and CLASSHUB, an all-in-one wireless presentation product, to support various applications in the smart classroom for connection, presentation, and collaboration purposes.

## Value Props



Enable smart classrooms by integrating intelligent hardware and software with existing classroom equipment



Streamline classroom management with a media service platform that supports local and remote operations



Enhance teaching effectiveness by generating insights from high quality local application data, remote statistics data, and more

## Intel Components

- Intel® Celeron® processors
- Intel® Core™ i3 processors

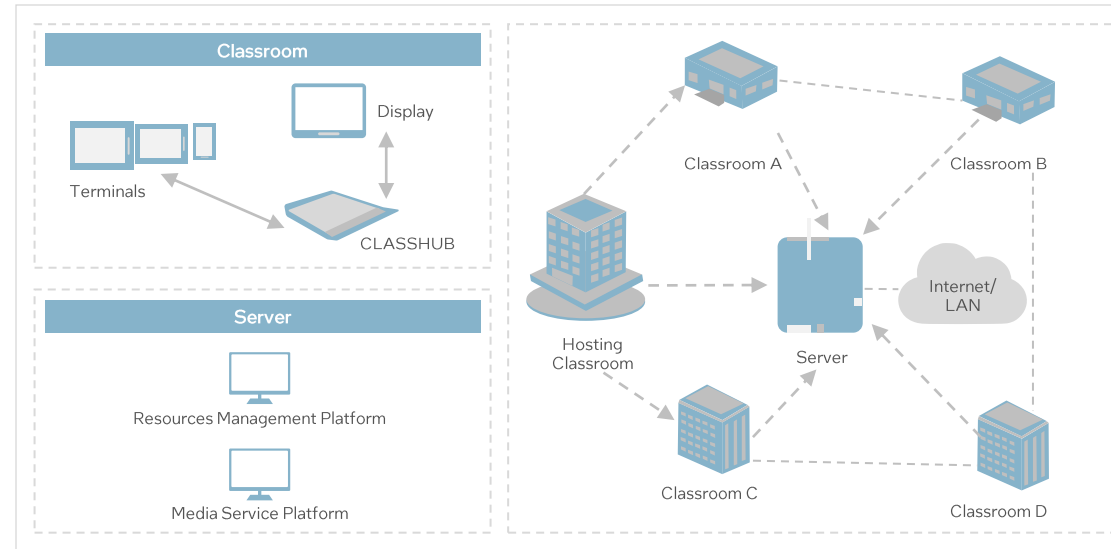

Target Vertical: [Education](#)

Secondary Verticals: [Government](#); [Health & Life Sciences](#)

Target Use Case: [Interactive Media](#)

## Geo Availability

Russia, Sub-Saharan Africa, and People's Republic of China

## Learn More

- [Solution Webpage](#)
- [Nanjing Mythware Information Technology Website](#)
- [Contact Information](#)

# NCR Emerald Retail Point of Sale Platform

## Solution Overview

The NCR solution is an all-in-one POS system that allows users to centrally configure, manage, and control all edge points in real-time for a seamless customer experience and business efficiency. It provides central reporting and analytic capabilities to enable enterprise-wide views for better and faster decision-making that gives retailers a competitive edge.

## Value Props

- Accelerate deployment with out-of-the-box integrations to enable retailers to leverage existing IT investments for fast and convenient NCR POS upgrades
- Enhance customer journeys with a cloud-enabled POS infrastructure that allows retailers to easily add new business services, like digital commerce and coupons
- Increase operational efficiency with a POS and enterprise system that includes secure payment gateways and inventory management for cost-savings

## Intel Components

Intel® Core i3 and i5 processors

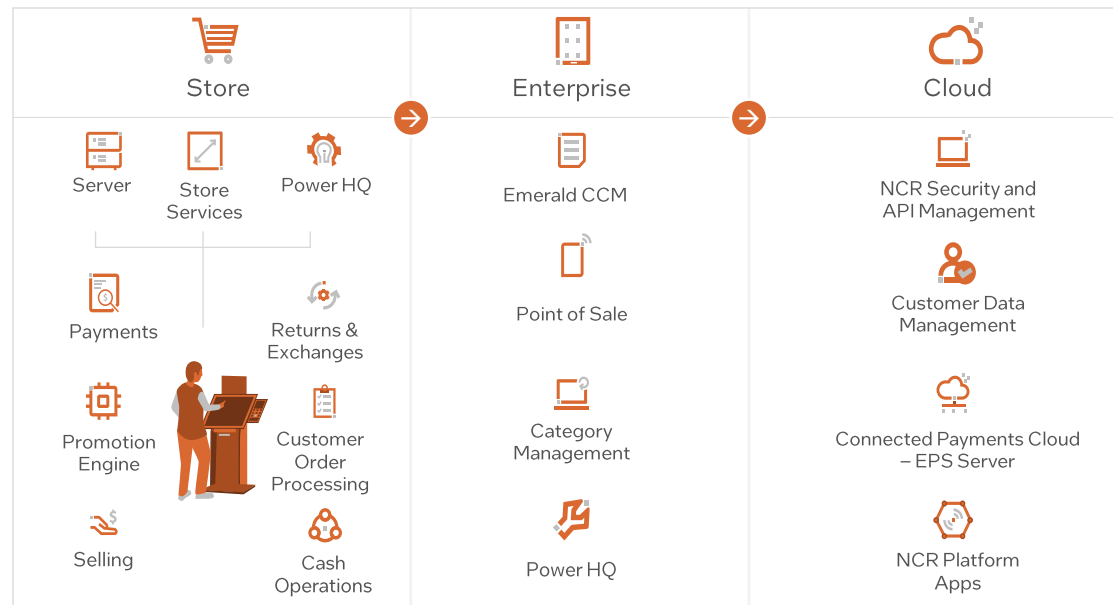

Target Vertical: Retail

Target Use Case: Asset & Operations Optimization

Secondary Use Case: Interactive Media

### Geo Availability

Available in the United States and Canada.

### Learn More

- [NCR Website](#)
- [NCR Emerald](#)



# NCR FastLane SelfServ Checkout

## Solution Overview

The NCR FastLane SelfServ Checkout solution enhances customer shopping experiences. Businesses can take advantage of new ways to scan, bag, and pay for items while helping improve front-end efficiencies. The solution helps self-checkout transactions become more accurate and simpler to navigate.

## Value Props



Enhance customer journeys with smart self-service technologies with familiar digital interfaces



Improve operational efficiency with computer vision and weight-based algorithms to accurately identify products



Increase ROI with convenient, interactive self-checkout units that reduce operational costs

## Intel Components

- Intel® Core™ i3 processors
- Intel® Core™ i5 processors
- Intel® Celeron® processors

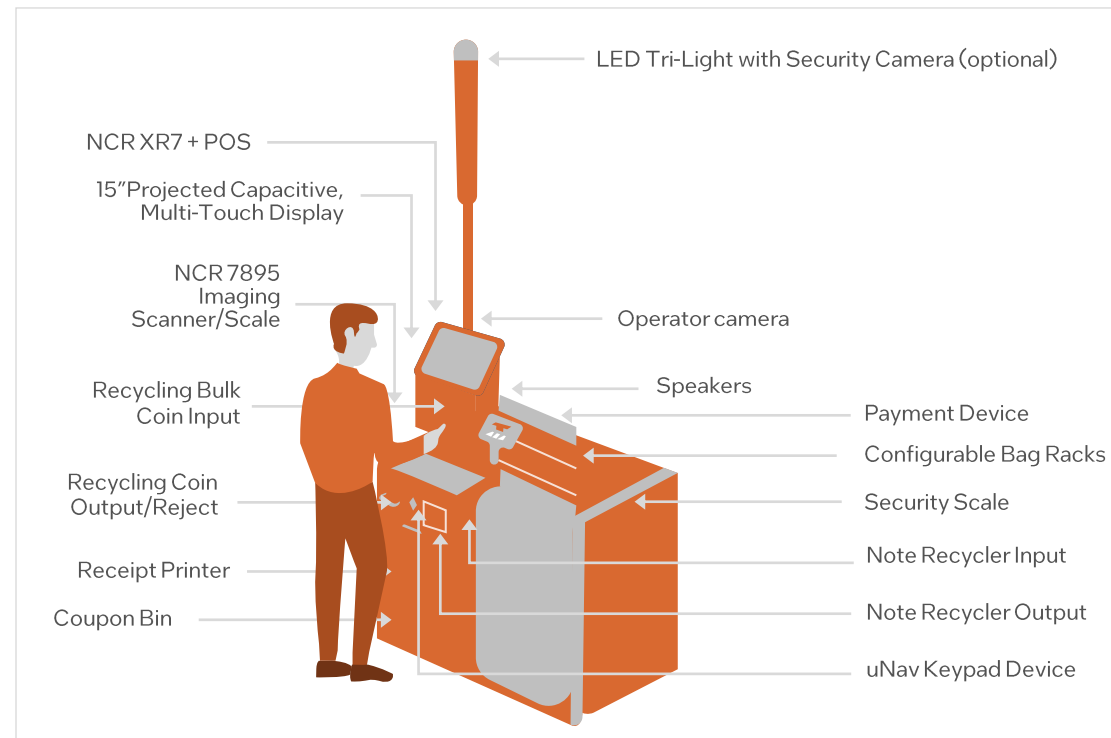

Target Vertical: Retail

Target Use Case: Other  
Secondary Use Case: Interactive Media

## Geo Availability

Available in Canada, Mexico, United States, Australia/New Zealand, Japan, South Korea, Taiwan, Germany, Israel, Middle East, North Africa and Turkey, Russia, Sub-Saharan Africa, United Kingdom, Other Americas

## Learn More

- [NCR website](#)
- [NCR FastLane SelfServ Checkout](#)
- [Greer's Market - Customer Case Study](#)



# NEC SDM Integrated ECO-System

## Solution Overview

The SHARP NEC SDM Large Slot-in PC is configured for demanding digital signage applications in sheltered transportation and retail environments. The SDM Large Slot-in PC is also optimized for office applications, such as video conferencing, interactive whiteboards and can gather and manage data through multiple sensors, ports, networks and analytics suites.

## Value Props

- Connects a wide range of display and installed assets with an integrated multiport system designed to accommodate ethernet, USB, HDMI, MiniDP++, RFID, 1/8 auxiliary and coaxial connections
- Enables seamless content delivery with a high-powered display solution ranging 4 – 32GB of RAM, 64 – 1024GB storage, and a dedicated graphics processor
- Provides a diverse range of actionable insights and controls through a system designed to process and analyze large quantities of device and usage data

## Kit Components

- Intel® Core™ i3 Processors
- Intel® Core™ i5 Processors
- Intel® Celeron® Processors
- Intel® UHD Graphics Controller

NEC Large Format Display SDM Integrated ECO-System

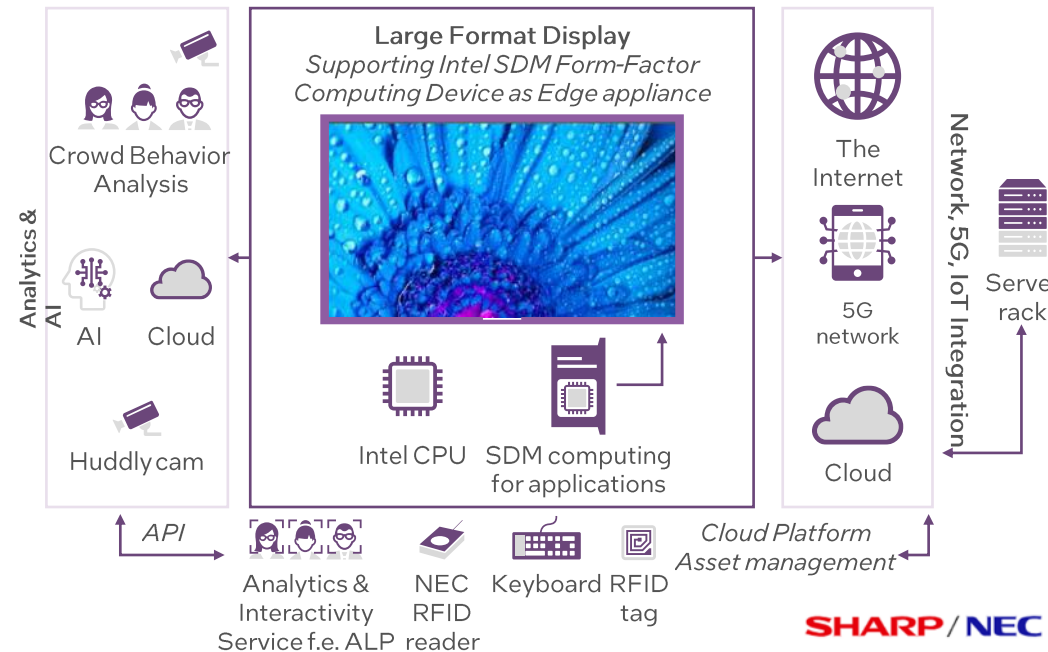

## Target Vertical:

Government, Transportation

## Secondary Vertical:

Retail, Signage, Corporate

## Target Use Case:

Control Optimization & Autonomy, Embedded Computing within Signage applications

## Secondary Use Cases:

Interactive Media, Asset & Operations Optimization

## Geo Availability

Asia, Pacific, and Japan, Americas, Europe, Middle East and Africa, PRC

## Learn More

- [Digital Signage - Sharp NEC Display Solutions](#)
- [Meetings & Conferences - Sharp NEC Display Solutions](#)



# Novarad Imaging Suite: Enterprise Imaging Management System, AR Surgical Guidance, and Image Sharing

## Solution Overview

Using Intel-based medical imaging technology with AI and AR, Novarad Imaging Suite helps hospitals and imaging centers improve accuracy of diagnoses, manage patient health, and increase efficiency for diagnostic care and treatment.

## Value Props



**Increase patient safety.** Improve accuracy of diagnoses by bringing together all images, including photos and videos, with Enterprise Imaging technology. VisAr's surgical augmented reality provides 3D renderings of radiology images overlaid onto patients' bodies, increasing the safety of, or avoiding unnecessary surgical procedures.



**Reduce operational costs.** With Enterprise Imaging, Novarad streamlines practices around patient data to reduce manual labor by removing gaps from workflow and identifying ways to aggregate all relevant patient data. Use of the NCompass single archive eliminates the need for IT to manage multiple storage platforms.



**Enhance patient experience.** Easily show patients all information relevant to their case, creating unique moments where education, care, and treatment intersect. With CryptoChart image sharing, patients are empowered in their care with easier access to their images via QR codes and a universal viewing interface.

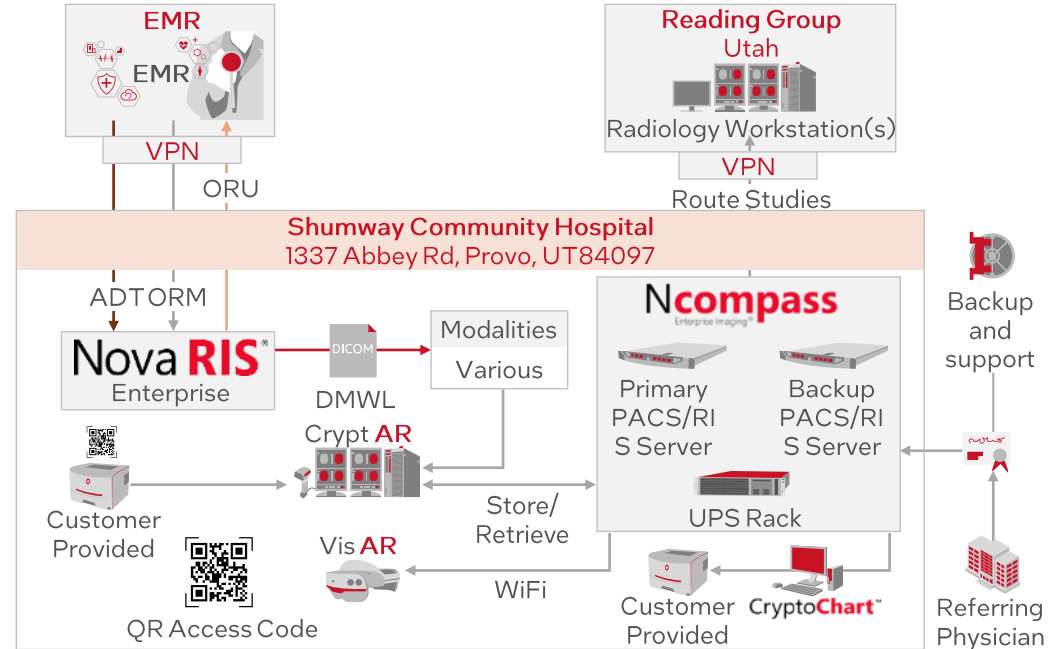

## Intel Components

- Intel® Xeon® Processors
- Intel® Solid State Drives
- Intel® Core™ i5 Processors

**Target Vertical:**  
Health & Life Sciences

**Target Use Case:**  
Product Inspection

**Geo Availability**  
Global

### Learn More

- [The Novarad Website](#)
- [Opensight Augmented Reality Surgery](#)
- [CryptoChart CD-free Image Sharing](#)





# NTT System System Blue Bolt

## Solution Overview

In the real estate market, building owners and operators need to streamline their services for tenants and guests who desire seamless and connected experiences. Building operators are also looking to increase security and efficiency while reducing their operating costs. NTT System's Blue Bolt solution enables touchless interactions with traditional building systems via mobile app, offering end users more convenience across facilities and optimizing building access services, parking management, room booking, and more. In addition, building managers can easily deploy and manage a low-touch solution that augments building security and helps reduce their carbon footprint.

## Value Props

-  Create more seamless user experiences with a single app featuring diverse applications like managing building access, booking meeting rooms, renting parking spaces, and more
-  Help strengthen building security with a cloud-based platform that manages access via mobile permissions and helps reduce risks associated with stolen access cards and unverified people on premises
-  Implement with legacy building systems easily through a highly compatible software platform that supports robust third-party integrations and has minimal physical installation requirements

## Intel Components

- Intel® Core™ Processors
- Intel® Xeon® Processors
- Intel® NUC Kits

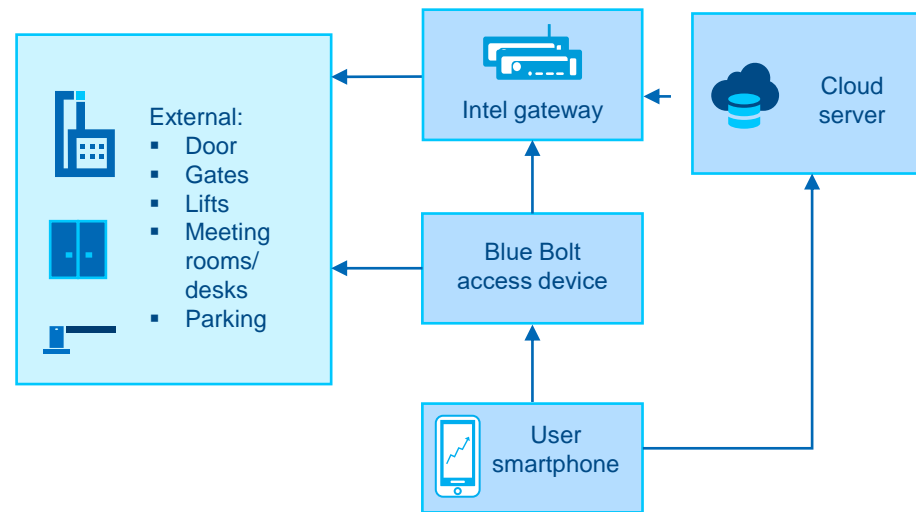

Target Vertical:  
Hospitality

Target Use Case:  
Asset & Operations  
Optimization

Geo Availability  
Europe, Middle East, Africa

Learn More  
Blue Bolt Website



# Ocuvera Fall Prediction & Monitoring

## Solution Overview

The Ocuvera Patient Fall Prediction and Monitoring solution is an Automated Video Monitoring system that monitors patient behavior from both hospital beds and chairs, replacing the need for personnel to continuously monitor patients. Ocuvera's AVM is designed as an early warning system that can reduce patient fall risk by detecting potential falls before they occur.

## Value Props

- Increase patient safety** by preventing falls by over 37% and preventing unwanted bed exits by up to 97.4%
- Reduce staffing workload and increase flexibility** with accurate monitoring using live video alerts, allowing nurses to check in on patients and reduce alarm fatigue from traditional methods
- Reduce accident-related costs** by avoiding the burden of injury-related falls

## Kit Components

- Intel® NUC
- Intel® Distribution of OpenVINO™ Toolkit

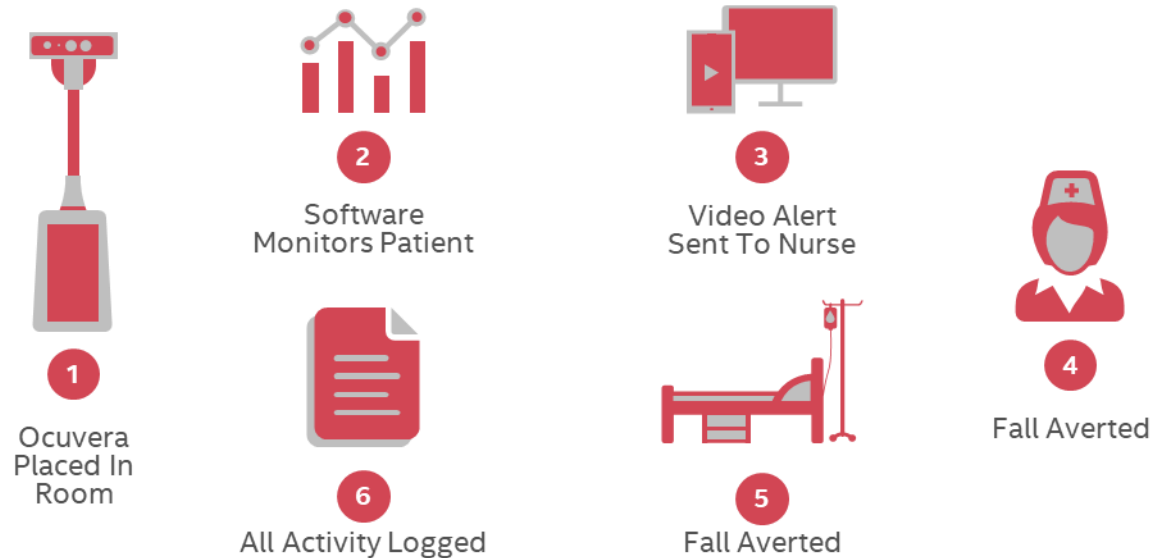

**Target Vertical:**  
Health and Life Sciences

**Target Use Case:**  
Human Wellness Monitoring

**Secondary Use Case:**  
Situational Monitoring

**Geo Availability**  
United States

**Learn More**  
Ocuvera Website



# Olea Kiosks Inc. Healthcare Check-in Kiosk

## Solution Overview

The Olea Healthcare Check-in Kiosk provides an easy-to-use digital interface that streamlines check-in processes, improves the patient experience, and alleviates pressure on healthcare staff. The self-service kiosk enables patients to complete check-in tasks electronically and automates administrative tasks so staff can devote more time to delivering exceptional patient care.

## Value Props



Increase efficiency and reduce errors by enabling patients to quickly and accurately enter their own information without waiting on staff for assistance



Lower operational costs by streamlining the collection of patient data and helping optimize arrival times and staff timing



Reduce patient wait times with self-service kiosks that automate check-in tasks so fewer patients spend time in waiting areas

## Intel Components

Intel® Core™ i5 processors

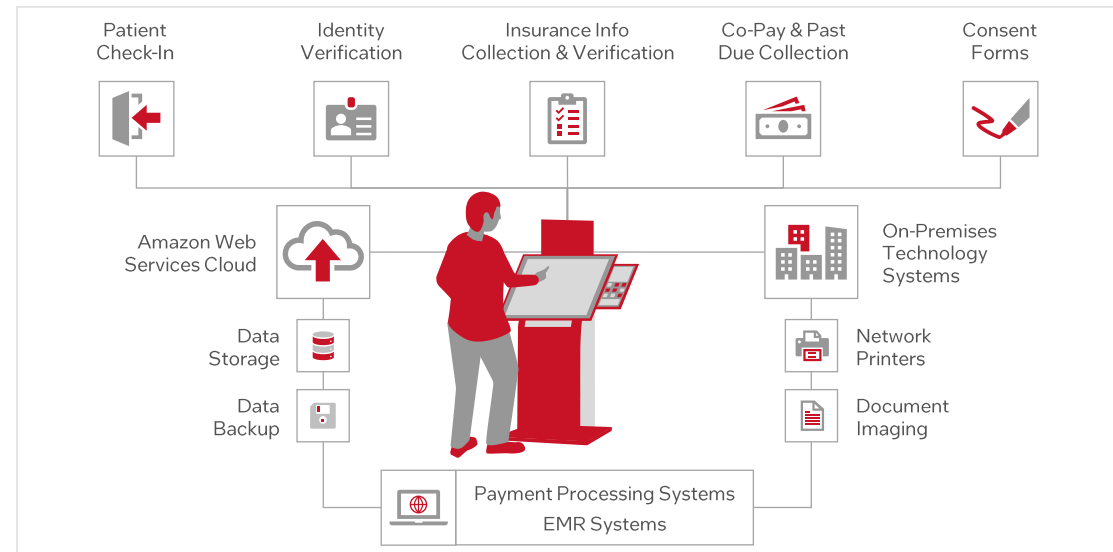

**Target Vertical:** Health & Life Sciences

**Target Use Case:** Interactive Media

### Geo Availability

US and Canada with opportunities to deploy globally for larger volume deals (dependent on shipping costs, customer needs, and software partner)

### Learn More

- [Olea Kiosks Inc. Website](#)
- [Healthcare Check-in Kiosk Brochure](#)

# Olea Kiosks Inc. Ticketing and Booking Kiosks

## Solution Overview

The Olea Kiosk is designed to help businesses increase profitability and optimize foot-traffic management using a customized system to meet a business' specific needs. By increasing transaction speed and providing engaging interactive functionalities, these kiosks can quickly generate revenue and augment customer experiences.

## Value Props



**Reduce operating costs** by deploying a solution that automates repetitive tasks like order taking and payment processing allowing staff to focus on higher valued tasks



**Improve guest experiences** by providing a contactless solution that expedites the transaction process through intuitive applications so guests spend less time waiting in lines to get service



**Generate key data insights** for decision-makers by tracking consumer behaviors such as interaction time, selection preferences, and total spend

## Kit Components

- Intel® Core™ i5 Processors

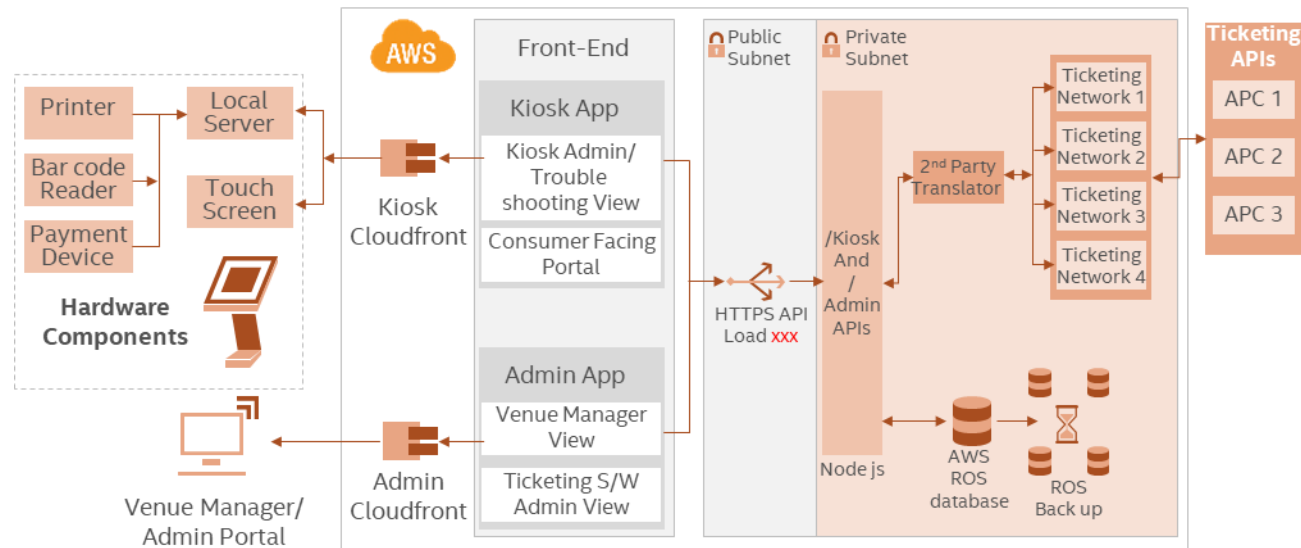

**Target Vertical:**  
Other

**Secondary Vertical:**  
Hospitality, Retail, Transportation

**Target Use Case:**  
Interactive Media

## Geo Availability

Canada; Mexico; USA; Other Americas; AUS/NZ; India; Japan; South Korea; PRC; ROC; Germany; Israel; Middle East, North Africa; Turkey; Russia; Sub-Saharan Africa; UK

## Learn More

- [Olea Kiosk Manufacturer](#)
- [Ticketing Kiosk for Movie Theaters & Theme Parks by Olea Kiosks, Inc](#)

# Ombori Apps AB Grid Compute Device

## Solution Overview

The Ombori Grid Compute Device powers digital experiences in physical spaces by bridging cognitive services, IoT, digital screens, and mobile devices. Ombori offers out-of-the-box solutions that can be deployed to devices with a single click, and enables partners and internal resources to build and manage their own interactive solutions.

## Value Props



Enhance Customer Experience with a seamless in-store experience, and by leveraging shopper behavior analytics to best anticipate and respond to consumers



Help improve safety through automated store capacity and shopper distancing controls



Increase sales through intuitive and easy-to-use entry procedures and curbside pickup processes

## Intel Components

- Intel® Core™ i3 processors
- Intel® NUC

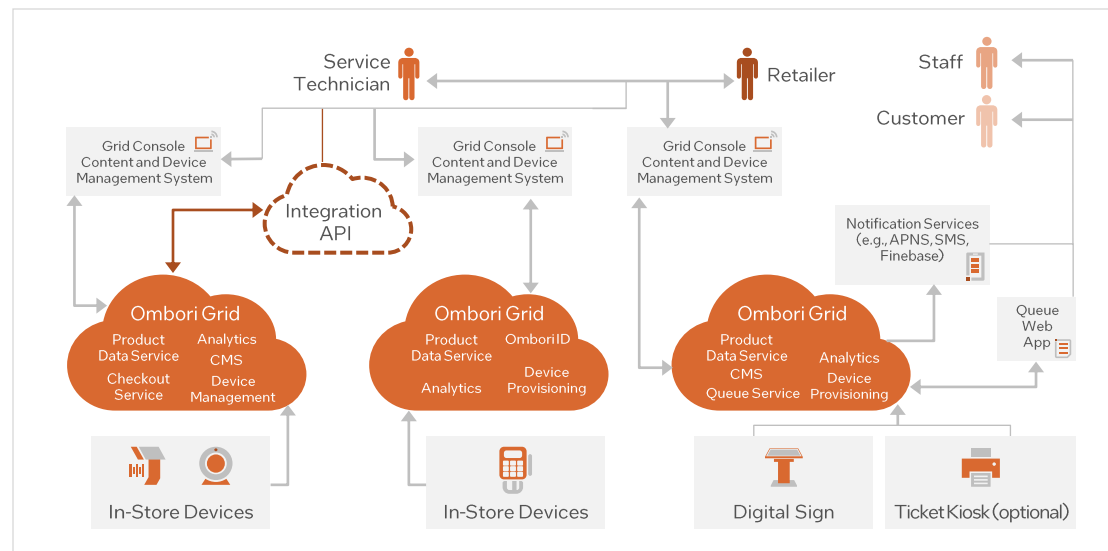

**Target Vertical:** Retail

**Secondary Verticals:** Banking/Financial Services, Health & Life Sciences, Hospitality, Government

**Target Use Case:** Interactive Media

**Secondary Use Cases:** Asset and Operations Optimization, Control Optimization and Autonomy

**Geo Availability**  
Available Globally

## Learn More

- [Ombori - Intel® Solutions Marketplace](#)
- [Ombori case studies](#)
- [Ombori case videos](#)
- [Ombori blog](#)



# Omnivex Moxie Digital Signage

## Solution Overview

The Omnivex Moxie solution empowers interactive digital communications through an intuitive content management platform. With the intelligent use of data, Omnivex can manage a large network of digital signage under one unified management system.

## Value Props

- Display real-time information on any screen
- Enhance customer experiences with interactive digital screens and wayfinding
- Increase revenue streams by selling advertising space on digital signage
- Optimize digital communications with a unified content management system

## Intel Components

- Intel® Atom® Processor X Series
- Intel® Core™ i5, i7, & i9 Processors
- Intel® NUC

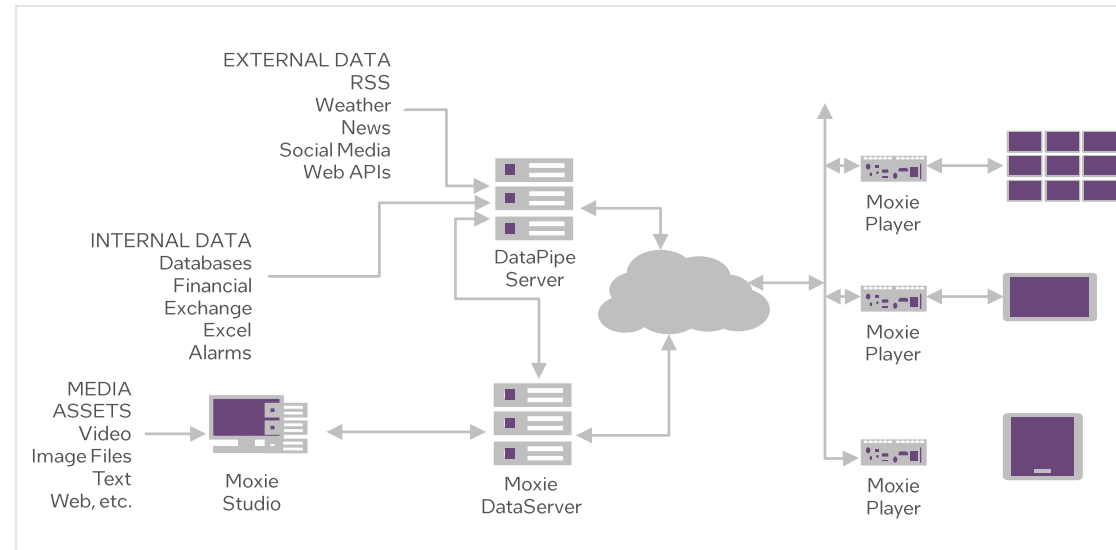

**Target Vertical:**  
Transportation, Corporate communications

**Secondary Verticals:**  
Banking/Financial Services,  
Health & Life Sciences,  
Manufacturing,

**Target Use Cases:**  
 Corporate Communications,  
Interactive Media

**Geo Availability**  
 Available worldwide

## Learn More

- [Omnivex Moxie Platform Solution](#)
- [Intel Solutions Marketplace](#)
- [Omnivex Moxie Videos](#)

# Onesait Active Grid Management Suite

## Solution Overview

A novel IoT platform that combines an open architecture with state-of-the-art analytics to effectively monitor and manage the energy grid

## Value Props



Reduce costs by optimizing asset monitoring and management across the grid



Improve grid reliability through a robust open architecture and early warning reports



Enable new use cases with grid interoperability, scalability, and analytics-driven insights

## Intel Components

- Intel Atom® E3800 and Intel® HD Graphics
- Intel® Xeon® Processor Scalable Family-based 3<sup>rd</sup> Party Cloud

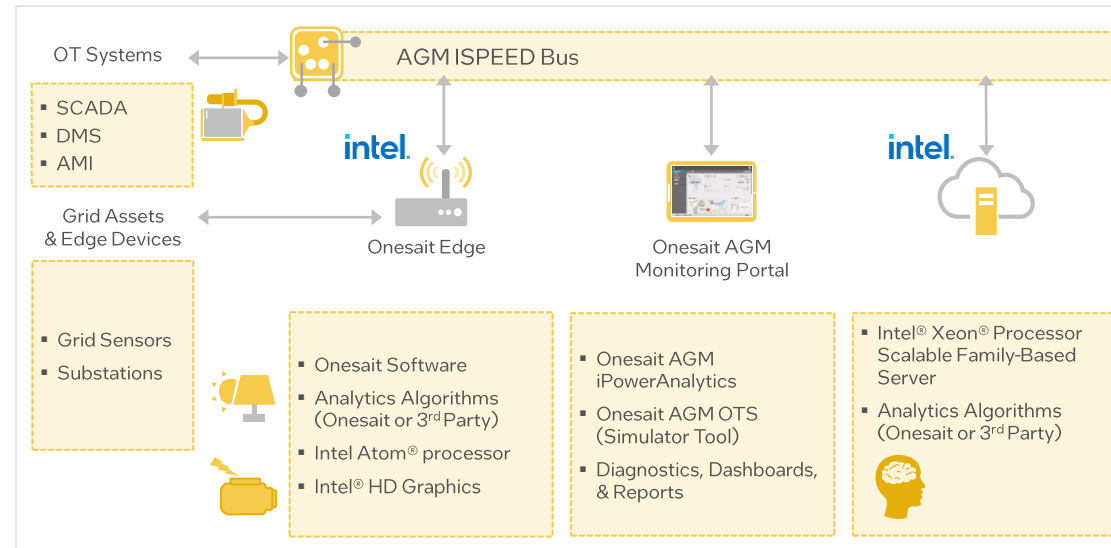

**Target Vertical:** [Energy](#)  
**Secondary Verticals:** [Retail Banking/Financial Services](#), [Hospitality](#), [Education](#)

**Target Use Case:** [Energy Monitoring & Management](#)  
**Secondary Use Cases:** [Machine Condition Monitoring](#), [Asset & Operations Optimization Environment](#)

**Geo Availability**  
 Worldwide with a focus on Latin America, Philippines, Europe (esp. Germany), USA, Australia, New Zealand, some countries in Africa

### Learn More

- [Onesait Active Grid overview](#)
- [Onesait Grid AGM overview](#)
- For more about Intel in Smart Grid Energy, see [Intel in Energy](#)

# OnLogic – Ignition SCADA Solution

## Solution Overview

A SCADA solution that helps businesses make actionable decisions through process management trend observation, and data analysis by bringing the powerful Ignition platform from Inductive Automation to the edge.

## Value Props

Integrate with existing equipment easily and a wide range of industrial I/O

Build E2E IoT architecture that reduces bandwidth and associated costs

Increase real-time control of processes for better monitoring and business decision making

## Intel Components

Intel® Celeron®, Atom®, Pentium®, and Core™ processors

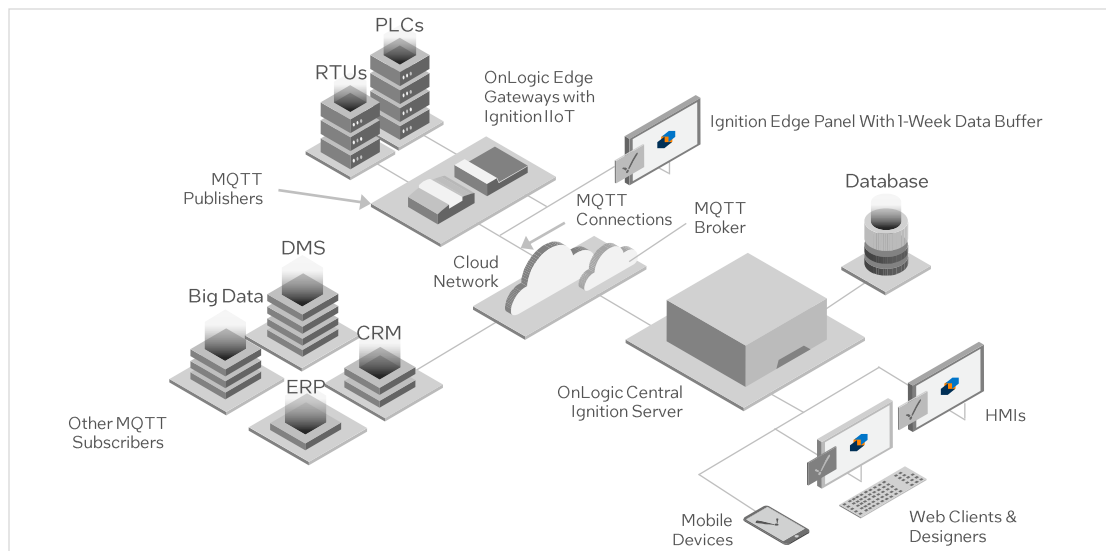

**Target Vertical:**  
Manufacturing

**Target Use Case:** Asset & Operations Optimization

## Geo Availability

Solution currently available in US and EMEA

## Learn More

- [Hardware](#)
- [User Manual](#)
- [Knowledge Base](#)
- [Forum](#)
- [Product Page](#)
- [Case Study](#)

# OnLogic Singlewire InformaCast Fusion Server

[Back to Government Solutions](#)

[Back to Logistics & Tracking Use Cases](#)



## Solution Overview

A cloud-based emergency notification system that delivers a leading software solution for fast and reliable emergency notifications. The InformaCast Fusion Server helps reach the right people, with the right information, to enhance awareness, safety, and security

## Value Props



Reach everyone by sending critical notifications to multiple communication devices



Monitor effectiveness of notifications through a variety of real-time tools



Generate emergency alerts via both personnel triggers and automatic triggers

## Intel Components

- Intel® Celeron® processors
- Intel® Pentium® processors

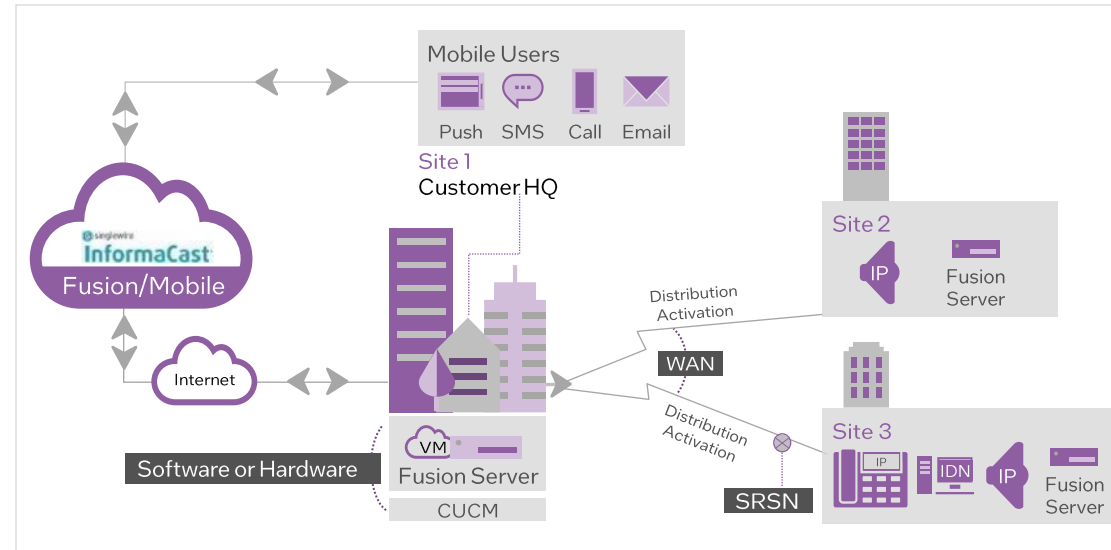

## Target Vertical:

Government

## Secondary Verticals:

Retail, Banking/Financial Services, Hospitality, Education, Health & Life Sciences, Transportation

## Target Use Case: Logistics & Tracking

Situational Monitoring, Environment Monitoring

## Geo Availability

US, EMEA, APAC, India, Australia

## Learn More

For more information visit the InformaCast website at: [www.singlewire.com/informacast](http://www.singlewire.com/informacast)

For quotes and ordering assistance visit the Singlewire contact page: [www.singlewire.com/contact-us](http://www.singlewire.com/contact-us)



Back to Education Solutions

Back to Human Wellness Monitoring Use Cases



# OnLogic ThingLogix Workwatch

## Solution Overview

Partnering with OnLogic, ThingLogix's Workwatch™ is an advanced compliance management solution using thermography, AI and sensor-based technologies for no-contact employee and visitor screening. The solution meets various institutional needs and compliance requirements to keep people safe through automated, efficient screening.

## Value Props



Maintain compliance using a workforce management solution with an intuitive interface that makes it simple to get up and running right away



Deploy easily whether hosted on Workwatch or a company account



Gain real-time monitoring capability through installation of multiple thermal camera-operated screening stations across locations

## Intel Components

10<sup>th</sup> Gen Intel® Core™ i7 and i9 processors

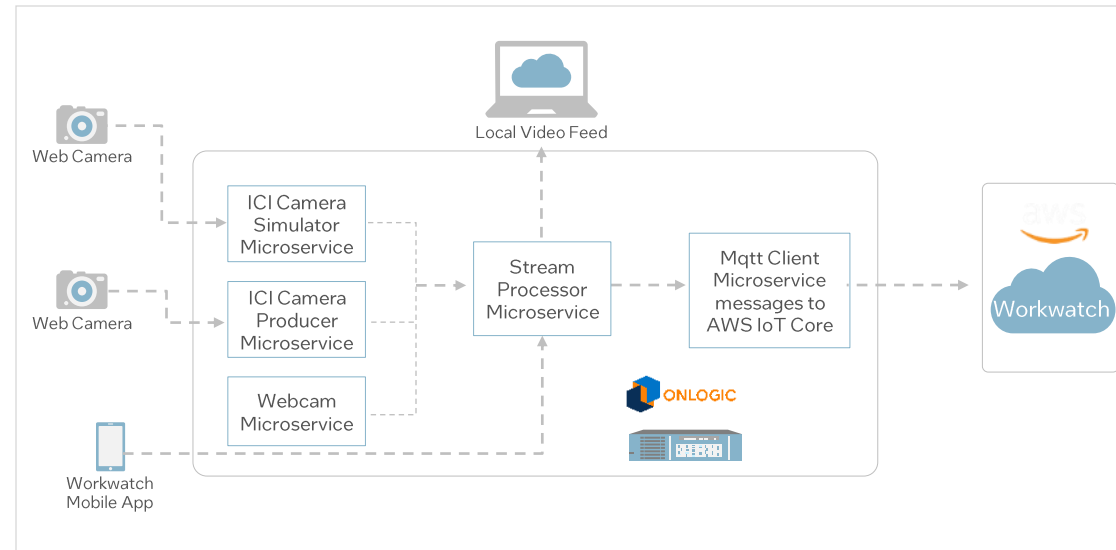

Target Vertical: Education

Secondary Verticals: Banking/Financial Services; Hospitality; Government; Retail; Transportation

Target Use Case: Human Wellness Monitoring

Secondary Use Case: Situational Monitoring

Geo Availability

North America and EMEA

Learn More

- [ThingLogix Workwatch webpage](#)
- [OnLogic.com](#)



# Onyx Intelligent Healthcare Interoperability Platform (iHIP)

## Solution Overview

The Onyx Intelligent Healthcare Interoperability Platform (Onyx iHIP) enables ability to discover and develop network computing platforms that contribute to the healthcare IoT and facilitate the adoption of AIoT. Onyx iHIP enables seamless information transfer to healthcare workers, identifies at-risk patients for timely intervention, offers continuous monitoring for improved patient recovery, and tracks biometric trends to assist with clinical decision making.

## Value Props



Reduce hospital readmission by improving patient visibility via patient monitoring and automatic risk alerts



Improve patient health outcomes through flexible communication between patients and healthcare professionals



Streamline healthcare professional workloads by integrating remote monitoring that allows a single technician to keep track of multiple patients

## Intel Components

- Intel® Core™ i5 processors
- Intel® Celeron® processors
- Intel Atom® processors
- Intel® Xeon® processors
- Intel® Movidius™ VPUs

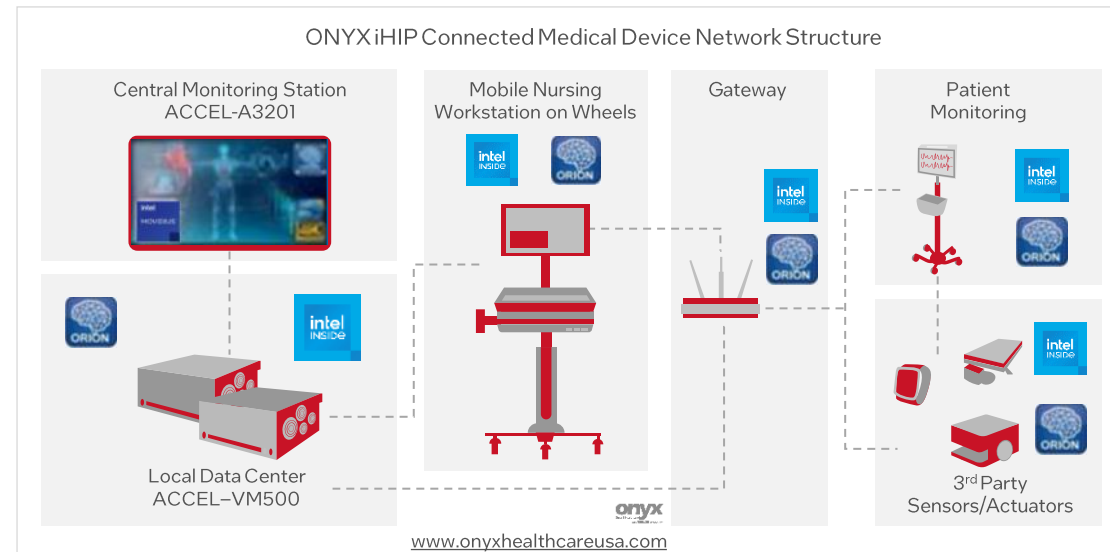

Target Vertical: Health & Life Sciences

Target Use Case: Asset & Operations Optimization

Geo Availability  
United States and Canada

Learn More  
[Onyx Website](#)



# ORISOL Production Data Collection System (PDCS)

[Back to Manufacturing Solutions](#)

[Back to Machine Condition Monitoring Use Cases](#)



## Solution Overview

ORISOL Production Data Collection System (PDCS) is a digital software management & cloud service solution designed for footwear manufacturing industry. PDCS enables the manufacturer to monitor relevant outputs and real-time parameter data from ORISOL equipment.

## Value Props



Improve productivity by utilizing real-time data from machines to make necessary adjustments for product output



Minimize machine downtime with alarm notifications that alert which machine needs maintenance or attention



Maximize flexibility with effective capacity utilization and production load balancing

## Intel Components

- Intel® Core™ i3 Processors
- Intel® Core™ i5 Processors

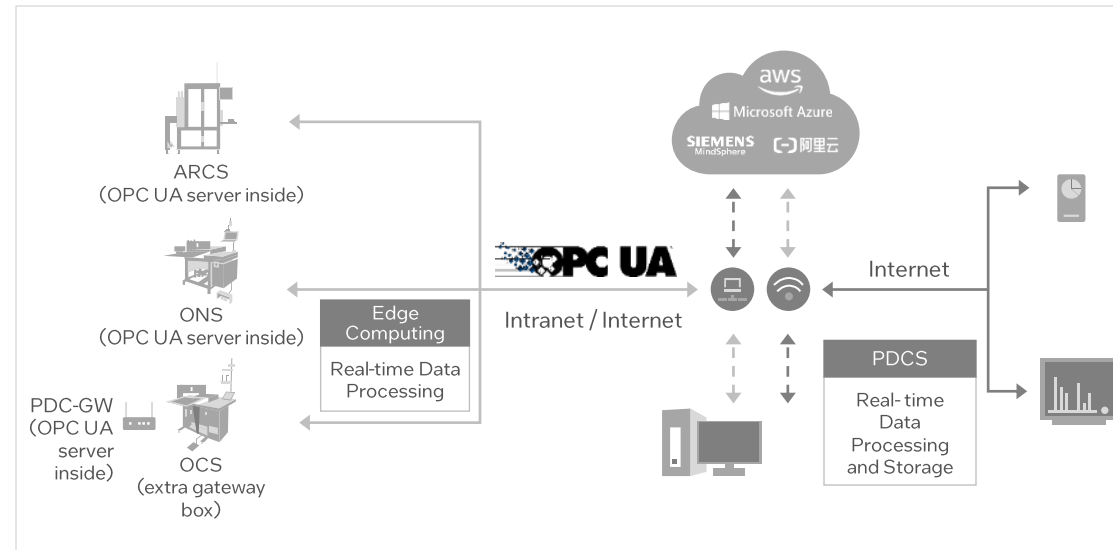

**Target Vertical:**  
Manufacturing

**Target Use Case:** Machine Condition Monitoring

**Secondary Use Cases:**  
Asset & Operations Optimization, Energy Monitoring & Management, Interactive Media, Situational Monitoring

**Geo Availability**  
Available globally

**Learn More**

- [PDCS Solution overview](#)



## Panasonic ArgosView

### Solution Overview

Panasonic ArgosView is a cutting-edge video solution that can record, distribute, manage, and process video footage from network cameras across a factory, store, or other location. Thousands of cameras and/or sensors can be monitored and managed from a single VMS platform, allowing customers to more efficiently access their data and gain actionable insights. ArgosView delivers compatibility with a wide variety of AI software offerings so customers can deploy AI monitoring within their environments while still managing from one convenient location.

### Value Props



**Streamline management** with a solution that gives customers the ability to connect cameras and sensors to one centralized location



**Improve efficiencies** with a solution that is customizable to fit customer's specific needs to enable more efficient use of video and other captured data



**Reduce costs** with a solution that can monitor energy consumption and equipment health in real-time and can control air conditioning and lighting

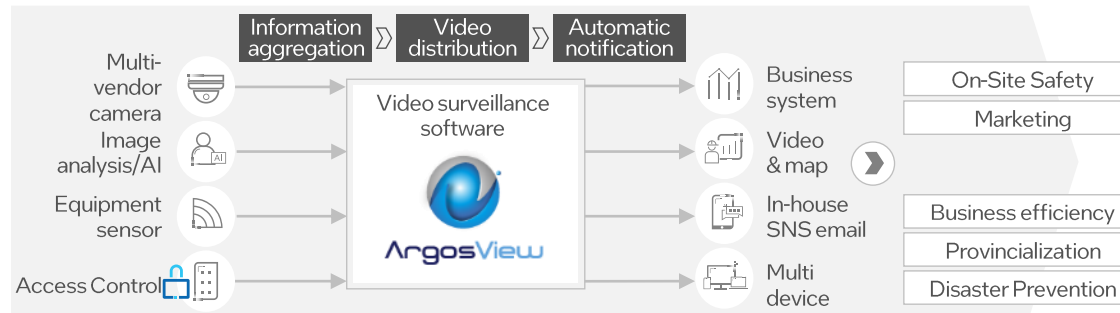

### Kit Components

- Intel® Xeon® SP Silver processors
- Intel® Core™ i7 processors
- Intel® Distribution of OpenVINO™ toolkit

**Target Vertical:**  
Manufacturing

**Secondary Vertical:**  
Banking/Financial Services,  
Education, Energy,  
Government, Hospitality  
and Restaurants, Retail,  
Transportation and  
Warehousing

**Target Use Case:**  
Environment Monitoring

**Secondary Use Cases:**  
Logistics & Tracking,  
Machine Condition  
Monitoring, Situational  
Monitoring

**Geo Availability:**  
Japan

**Learn More:**  
Panasonic ArgosView  
Website





# Partner Tech Smart Hotel Self-Service KIOSK

## Solution Overview

The Partner Tech Smart Hotel Self-Service KIOSK (AD-215-H) is a self check-in/check-out solution for hotels looking to enhance customer satisfaction, increase customer loyalty, and optimize resource allocation. The AD-215-H is designed for maximum efficiency, longevity, flexibility, and scalability and can be customized with a wide range of optional accessories to meet hotels' self-checkout needs.

## Value Props



**Increase customer satisfaction** by providing 24-hour service availability, increasing privacy and control, and reducing check-in/ check-out queues



**Optimize hotel resources** and increase productivity by allowing hotels to reallocate staff and equipment to higher-value tasks



**Help protect the public** by providing a contactless process as well as optional body temperature monitoring tools to minimize health-related concerns

## Proven Results

### Lan Kwai Fong Garden Hotel

- **The situation:** The hotel, located in Taiwan, was experiencing issues including a high staff turnover rate, a lack of well-trained staff, and customer frustrations over long queues.
- **The solution:** The Lan Kwai Fong Garden Hotel deployed the Partner Tech solution, as a counter-top self-service kiosk, to help address these issues.
- **The results:** Partner Tech customers say KIOSK accounts for 2+ staff/day, resulting in higher availability of service and about a 30% time reduction in check-in/out processes. They also report a 20% reduction in customer complaints.

## Intel Components

- Intel® Core™ i3 and i5 Processors
- Intel® Celeron® Processors



It is always difficult to find and retain a well-trained staff, especially at [a] small city. Lack of staff has always [caused] frustration to the customers, especially during peak holiday season. With... the Self-Service KIOSK, not only [has] my problem [been] resolved, but [it has] also enhanced customer satisfaction.



**Administration Manager,  
Lan Kwai Fong Garden  
Hotel**

**Target Vertical:**  
[Hospitality](#)

**Secondary Vertical:**  
[Retail](#)

**Target Use Case:**  
[Interactive Media](#)

**Secondary Use Cases:**  
[Control Optimization & Autonomy](#)

**Geo Availability**  
APJ

### Learn More

- [Product Webpage](#)
- [Product Video](#)



# Passengera Fleet Connectivity and Infotainment Solution

## Solution Overview

Passengera Fleet Connectivity and Infotainment solutions provide reliable, manageable and secure internet connectivity and infotainment platforms for transport vehicles over mobile data networks. The solutions also empower transportation organizations with fleet management and passenger data analysis capabilities.

## Value Props



**Reduce cost:** by decreasing mobile data costs for internet access through effective bandwidth management and content available onboard



**Generate a more loyal and consistent customer base:** by improving the passenger experience through services that provide high-quality entertainment and information



**Increase revenue:** by analyzing and using passenger data to effectively implement targeted services and advertisements

## Kit Components

- Intel® Core™ i5 Processors
- Intel® Atom® Processors
- Intel® Core™ i7 Processors
- Intel® Xeon® Processors

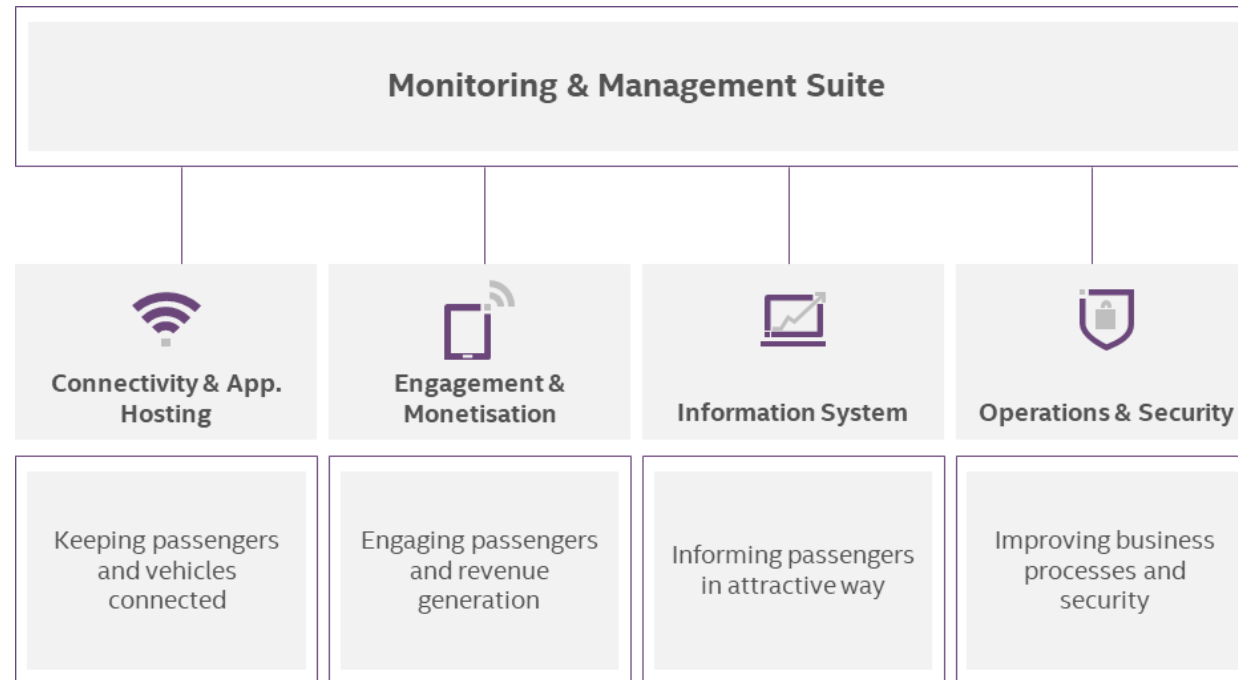

**Target Vertical:**  
Transportation

**Target Use Case:**  
Assets & Operations Optimization

**Secondary Use Case:**  
Workload Optimization

**Geo Availability**  
Globally

**Learn More**  
Passengera Website



# Pathr.ai Spatial Intelligence

Back to Retail Solutions

Back to Situational Monitoring Use Cases



## Solution Overview

As online retailers have unprecedented visibility into their shopper behavior, brick-and-mortar retailers are at a comparable disadvantage when it comes to acquiring insights surrounding their customers' in-store behavior. Pathr.ai Spatial Intelligence is a retail solution that anonymously captures customer and staff movement by leveraging existing cameras and data sources. The solution utilizes AI and edge servers to run computer vision detection and video analytics at the edge. Integrated onto a retailer's business system, Pathr.ai delivers actionable insights through customized dashboards and real-time alerts retailers can use to understand customer behavior within their stores to improve their fiscal and operational outcomes, delivering a +10x annual ROI<sup>1</sup>.

## Value Props



**Drive increased profit** with enhanced customer insights that facilitate data-driven business decisions and more efficient resource allocation to reduce costs, increase sales velocity, and unlock +10x ROI each year<sup>1</sup>



**Boost ROI** of existing infrastructure by integrating new capabilities into pre-existing camera systems and seamlessly scaling successful implementations across thousands of stores



**Help ensure privacy compliance** with a solution that is GDPR and CCPA compliant and doesn't measure personally identifiable information (PII) when capturing customer data

## Kit Components

- Intel® Xeon® SP Silver
- Intel® Xeon® SP Gold
- Intel® Movidius™ Myriad™
- Intel® Core™ i9 processors
- Intel® Distribution of OpenVINO™ toolkit

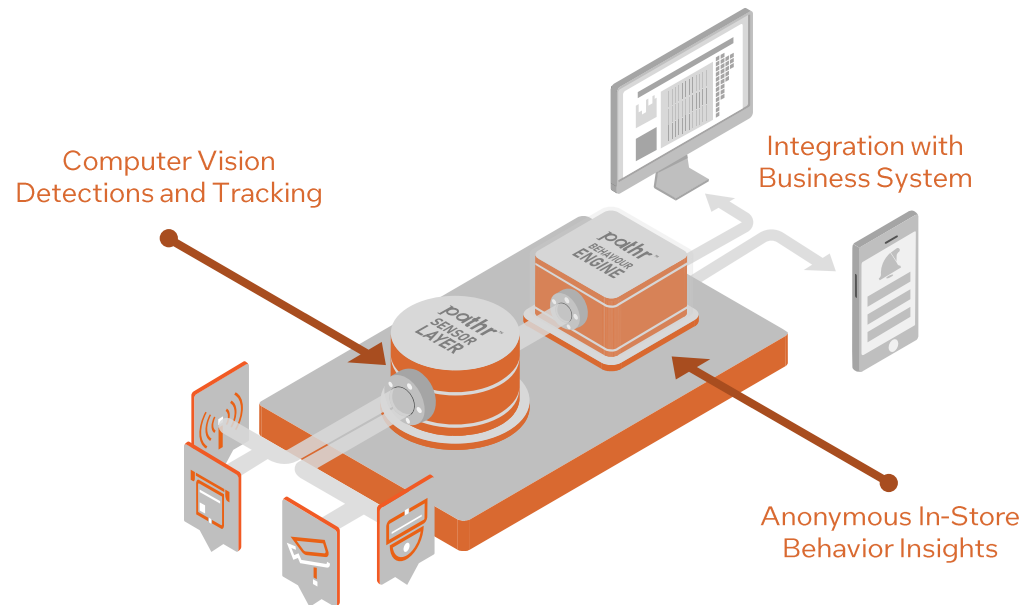

**Target Vertical:**  
Retail

**Secondary Vertical:**  
Warehousing and Distribution, Commercial Real Estate

**Target Use Case:**  
Situational Monitoring

**Secondary Use Case:**  
Asset & Operations Optimization

**Geo Availability**  
Americas, Europe, Middle East, APJ, Africa, People's Republic of China

**Learn More**  
<https://pathr.ai/Demo>  
[Intel & Pathr.ai Grocery Solution Brief](#)

1. [Pathr.ai](#), Why Pathr.ai?, 2022

# Perch Retail Displays

## Solution Overview

Perch's "lift-and-learn" retail displays include embedded IoT technology that unites digital content with physical products, delivering highly personalized product messaging upon customer interaction

## Value Props

- Detect shoppers as they approach to deliver highly personalized messaging
- Respond and Engage with interactive apps that help guide customers through their shopping experience
- Analyze and Manage in-store shopper analytics to determine messaging, pricing, packaging and merchandising effectiveness

## Intel Components

- Intel® NUC
- Intel® RealSense™ Technologies



Target Vertical: Retail

Target Use Case: Interactive Media

Secondary Use Case: Logistics and Tracking

Geo Availability: Globally

### Learn More

- [Perch Product 1-pager](#)
- [Perch Interactive Website](#)



# PerfectTron Level 4 Autonomous Shuttle

## Solution Overview

The PerfectTron Autonomous Shuttle navigates using radar, Lidar, GPS, odometry, and computer vision, maintaining eco-innovation and a high level of safety.

## Value Props



Environmentally Friendly – Limit noise and emissions with an electric, noiseless design



Safe – Deliver a safe and accessible transportation alternative with advanced perception technologies



Cost-Effective – Ease budgetary restraints thanks to reduced operating and infrastructure costs

## Intel Components

- Intel® Core™ i7 Processors
- Intel® QM77 and QM87 Chipsets

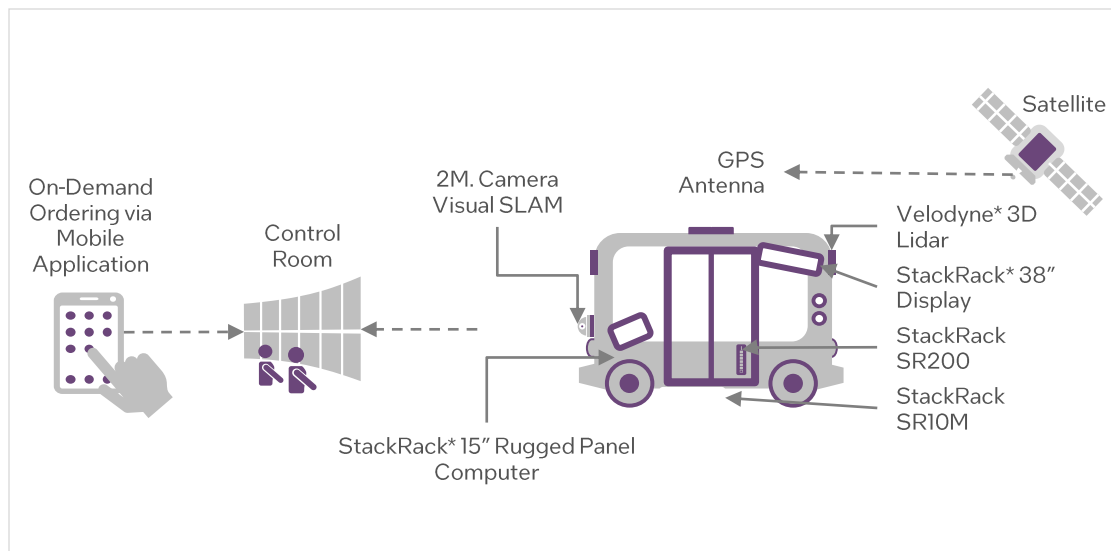

**Target Vertical:**  
Transportation

**Secondary Vertical:**  
Government

**Target Use Case:** Asset & Operations Optimization

**Secondary Use Case:**  
Control Optimization & Autonomy

### Geo Availability

Available in APAC, Japan, China, Australia, EMEA, North America

### Learn More

- PerfectTron Autonomous Shuttle [product website](#)
- EZ10 Shuttle product showcase [video](#)
- EZ10 [newsroom](#)
- EZ10 [product booklet and press kits](#)

# Petrosoft Cloud CStoreOffice®

## Solution Overview

The Petrossoft Cloud CStoreOffice® solution is a cloud-based back-office system designed to track inventory, pricing, revenues and workflow to increase operational efficiencies, improve earnings, and optimize merchandise, food, and fuel sales.

## Value Props

- Increase ROI through real-time inventory tracking and focused insights
- Streamline store operations through centralized management and point-of-sale solutions
- Improve inventory management through forecasted merchandise orders and better shrinkage management

## Intel Components

- Intel® Core™ i3 Processors
- Intel® Core™ i5 Processors
- Intel® Celeron® Processors

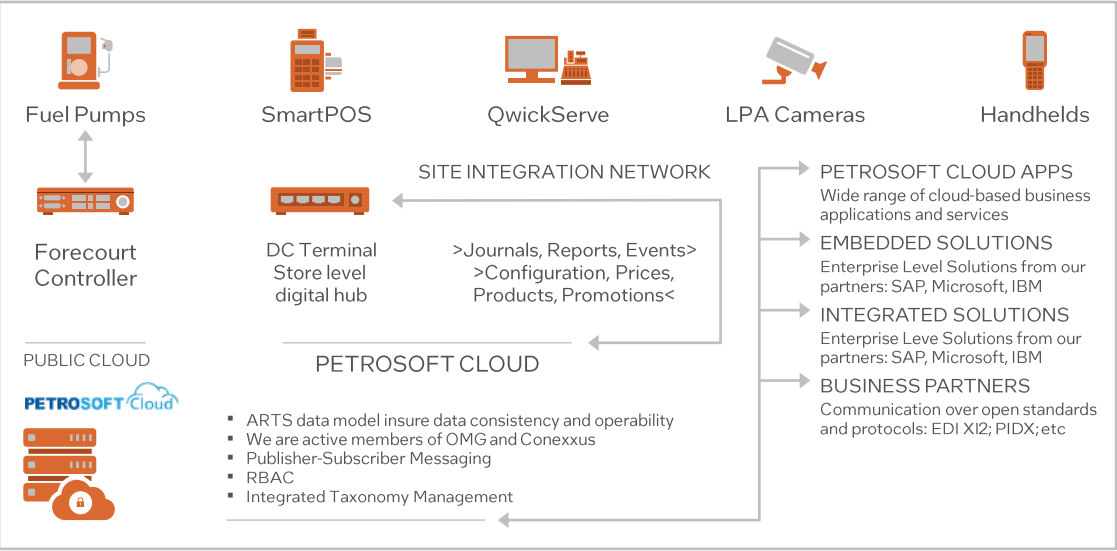

Target Vertical: Retail

Secondary Verticals: Hospitality, Convenience, Quick Service Restaurants

Target Use Case: Logistics & Tracking

Secondary Use Cases: Interactive Media, Inventory Control, Predictive Analysis

### Learn More

- [CStoreOffice® Solution Webpage](#)
- [SmartPOS Webpage](#)
- [Petrossoft Ecosystem](#)

# Phonexia Speech Platform

## Solution Overview

The Phonexia Speech Platform is a complete set of state-of-the-art speech technologies in a single software platform enabling audio analysis for defense and safety scenarios. Through big speech data analysis and voice biometric identification customers can utilize actionable insights in order to optimize investigations and public safety operations.

## Value Props

- Analyze audio data faster with accurate, AI-powered voice biometrics and speech analytics to uncover necessary context
- Integrate seamlessly into systems via a REST API with an on-premise or in the cloud, fully scalable modular solution
- Enhance investigative operations with automatic speech recognition and speaker identification to save staff time to focus on more valuable tasks

## Intel Components

- Intel® Xeon® Processors
- Intel® Core™ i7
- Intel® Core™ i5

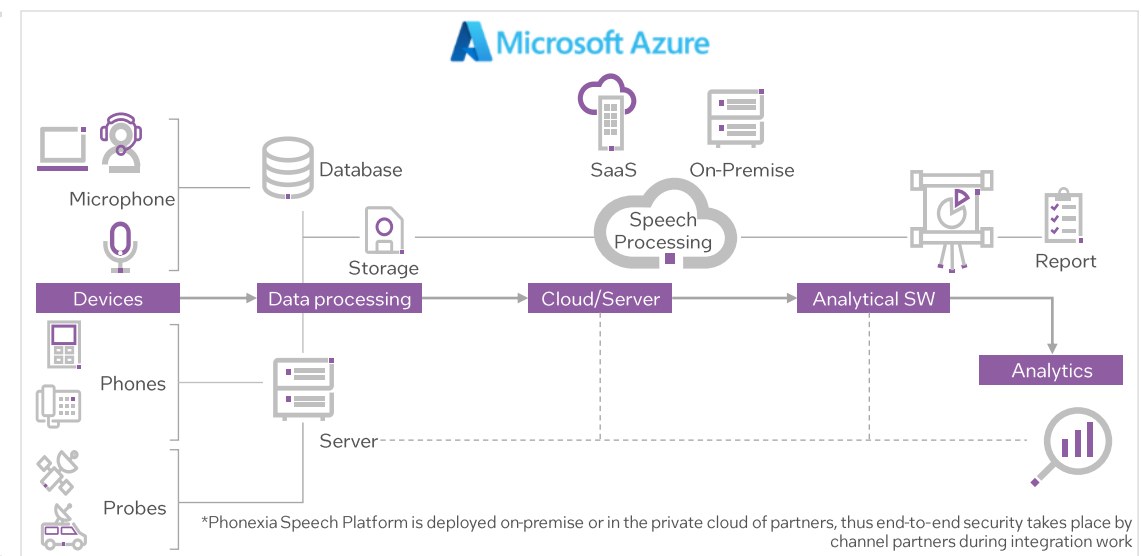

**Target Vertical:** Government  
**Secondary Verticals:** Banking/Financial Services, Manufacturing, Retail

**Target Use Case:** Other  
**Secondary Use Cases:** Control Optimization & Autonomy, Interactive Media

**Geo Availability**  
 Europe, Canada, Mexico, United States, Other Americas, Australia/New Zealand, India, Taiwan, Israel, Middle East, North Africa and Turkey, United Kingdom

- Learn More**
- [Phonexia Website](#)
  - [Phonexia Government Use Case](#)
  - [Phonexia Open-Source Acknowledgement](#)



# PMY Group Venues Facility and Transportation Optimization

## Solution Overview

The PMY Group Venues Facility and Transportation Solution enhances the gameday environment. Data is collected from sensors and cameras to optimize bus occupancy of vehicles, usage of key facilities and spaces, and utilization rates of parking spaces in different venues.

## Value Props

- Streamline Operations – Allow asset management to drive operational efficiencies through a data-driven approach
- Centralize Crowd Monitoring – Provide a centralized platform to influence crowd behavior and track crowd size and flow for additional health and safety precautions
- Leverage End-to-End Deployment – Program management, deployment, integration, and operations for all phases of project lifecycle

## Intel Components

- Intel® Distribution of OpenVINO™ toolkit
- Edge Software Provisioner
- SmartEDGE
- Intel® Xeon Processors
- Intel® Movidius™ VPUs

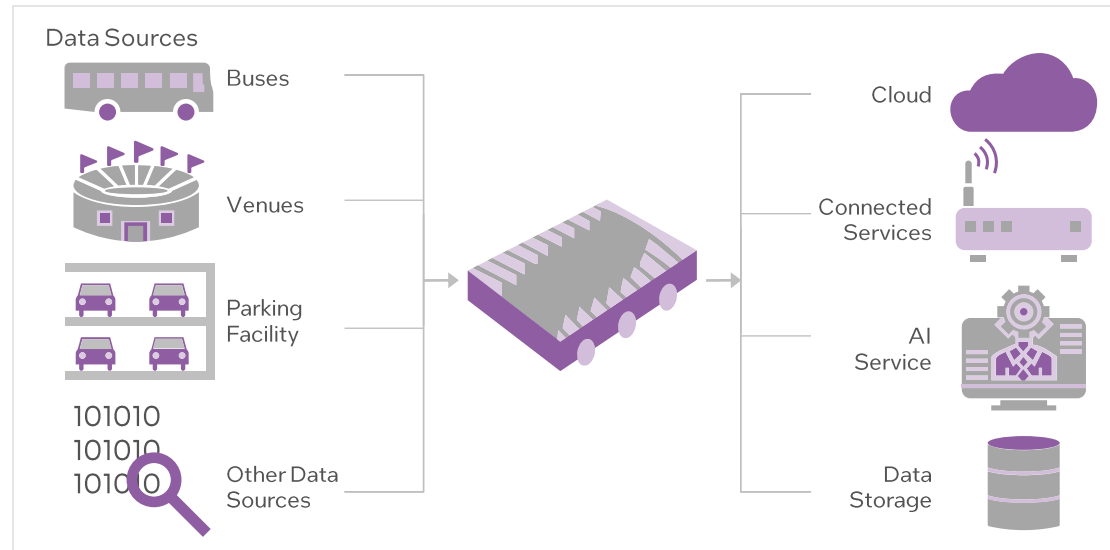

**Target Vertical:**  
Government

**Secondary Verticals:**  
Gaming and Entertainment;  
Hospitality; Retail;  
Transportation; Tourism;  
Education

**Target Use Case:** Asset and Operations Management;

**Secondary Use Cases:**  
Environment Monitoring;  
Logistics and Tracking;  
Situational Monitoring

**Geo Availability**  
Worldwide

**Learn More**  
[PMY Group Website](#)





Ponfac Count

Back to Manufacturing Solutions

Back to Product Inspection Use Cases

### Solution Overview

Ponfac Count is a full-stack IIoT solution which leverages the Ponfac Cube to photograph products and analyze them using AI. The Ponfac Cube is a smart camera device that takes product photos on factory lines using a variety of lenses and built-in edge solutions. Images are processed and optimized using computer vision with the help of Intel® Distribution of OpenVINO™ toolkit. The Ponfac Count solution then compares analysis of product photos to written invoices to ensure shipments or finished goods are accurate. Ponfac Count categorizes materials to ensure that they are delivered to the correct step of the logistical process. The solution stores data and then encrypts it before sending it to the cloud. Ponfac Count is username and password protected as well as secured by end-customer firewalls, VPNs, and other security rules.

### Value Props



Increase operational efficiencies by decreasing errors and eliminating the need for manual counting and classification, driving profitability

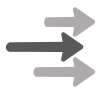

Improve performance by generating a high degree of accuracy in the inventory process using computer vision



Boost customer satisfaction by detecting errors early in the manufacturing process, ensuring finished products match end customer invoices

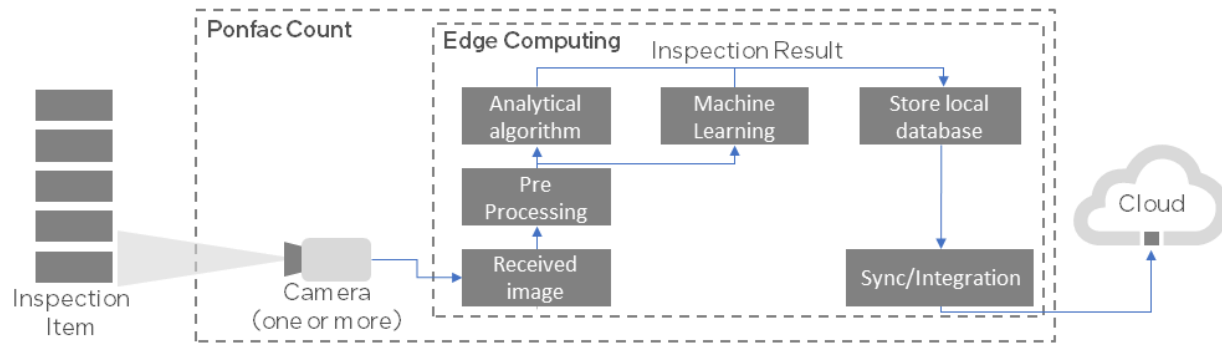

### Kit Components

- Intel® Core™ i5 Processors
- Intel® Core™ i7 Processors
- Intel® Distribution of OpenVINO™ toolkit
- Intel® NUC

Target Verticals:  
manufacturing  
Logistics and tracking,

Secondary Vertical:  
Transportation and  
Warehousing, Retail, Energy

Target Use Case:  
Product Inspection

Geo Availability  
Americas

Learn More  
▪ Ponfac Count

# Prescriptive Data NANTUM

## Solution Overview

A highly secure, scalable, and flexible IoT platform that creates smarter and more efficient buildings

## Value Props

- Reduce expenses and lower carbon footprint by improving energy efficiency
- Improve tenant retention by proactively managing buildings to increase comfort
- Optimize operational efficiency with more control and automation of building systems

## Intel Components

- Intel®-based Logic Supply ML100 Series NUC
- Intel®-powered IoT sensors and collectors
- Intel®-powered data center switching/routing
- NANTUM software designed to operate on Intel®-based gateways
- AWS Intel®-specified compute and processing

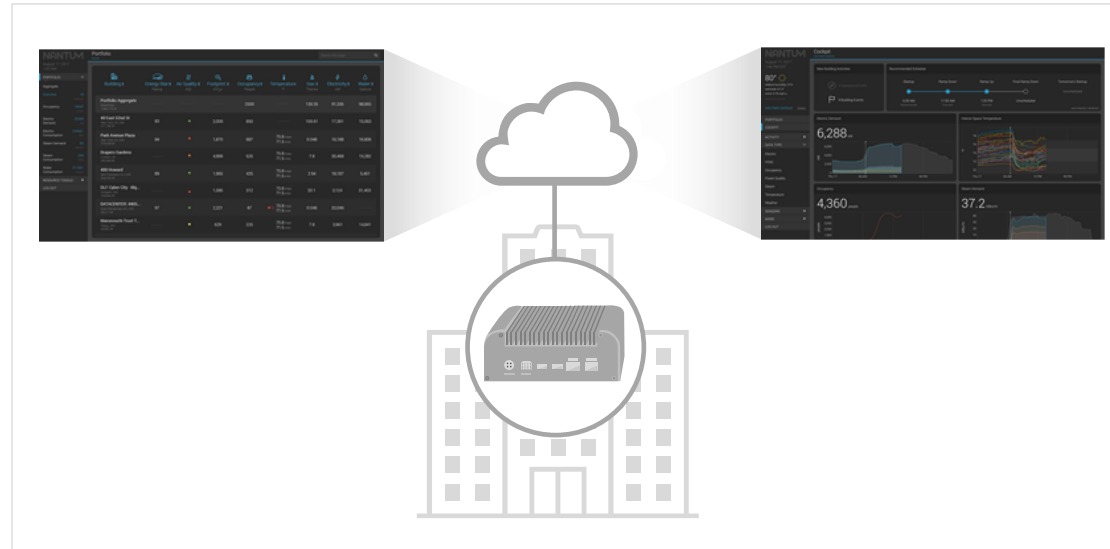

**Target Vertical:** Other  
**Secondary Verticals:** Retail, Banking/Financial Services, Hospitality, Education, Public Sector/Government

**Target Use Case:** Asset & Operations Optimization  
**Secondary Use Case:** Situational Monitoring, Environmental Monitoring

**Geo Availability**  
 North and South America

**Learn More**  
[Prescriptive Data NANTUM solution website](#)



## 5G Private Network Solution: Digital Resilience

### Solution Overview

As modern businesses and high-tech operations grow increasingly dependent on access to high-speed wireless data, so does their need for a diverse range of networking solutions. To address this demand, Pegatron developed the 5G Private Network Solution, a highly integrated and scalable edge computing platform with advanced network connectivity. Pegatron offers an end-to-end solution for 5G private networks with various 5G technologies and services to support cross-field applications.

### Value Props



**Provide reliable and complete communication** through 5G private network integration with orbital satellites that ensure uninterrupted connection services that support a diverse range of communication options



**Reduce overhead costs and improve carbon footprint** by implementing a solution that intelligently manages energy consumption by allowing 5G base stations to hibernate



**Improve operational efficiency** with a solution that utilizes digital resilience applications to manage assets within an enterprise infrastructure to maintain the ability to operate during business disruptions

### Kit Components

- Intel® Xeon® Processors
- Intel® Arria® Processors
- Intel® Ethernet Network Adaptors
- Intel® FlexRAN™
- Intel® DPDK
- Intel® Distribution of OpenVINO™ toolkit
- Intel® vRAN Accelerator
- Intel® QuickAssist Adapter

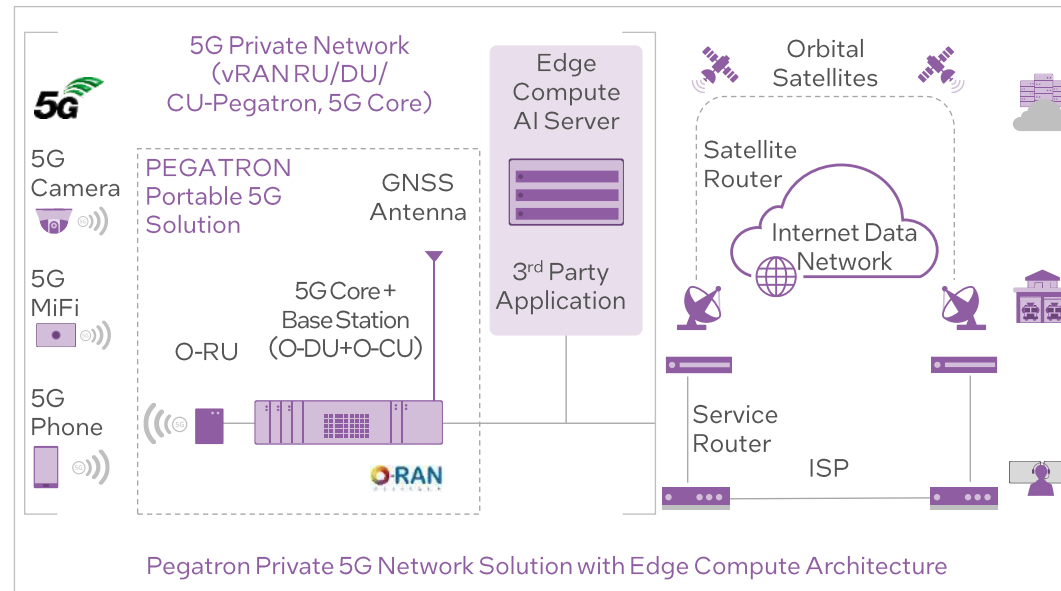

**Target Vertical:**  
Government

**Secondary Verticals:**  
Education, Health & Life Sciences, Manufacturing, Transportation & Warehousing

**Target Use Case:**  
Situational Monitoring

**Geo Availability**  
APJ, Americas, Europe, Middle East, and Africa

### Learn More

- [Pegatron – Home page](#)
- [PEGATRON 5G O-RAN E2E Private Network Solution - video](#)

# PreciTaste Prep Assistant

## Solution Overview

PreciTaste's Prep Assistant is a software automation solution designed to address the challenges faced by global foodservice operators. By leveraging AI-driven recommendations and historical data, it optimizes ingredient preparation, increases crew efficiency, reduces food costs, and enhances customer experiences. Through the power of edge and cloud connectivity, it enables real-time analysis, precise forecasts, and data-driven decision-making.

## Value Props

**Reduce labor costs and increase productivity** with automated calculations that decrease time spent on manual estimations and task management, saving both managers and crew members 1+ hour per day\* – allowing them to focus more on customer service and culinary creativity.

**Decrease food costs by up to 5%<sup>1</sup>** through a significant reduction in food waste, as the Prep Assistant significantly reduces overproduction through precise sales forecasts and ingredient prep instructions.

**Improve regulatory compliance, up to 99%<sup>2</sup>,** by providing an intuitive and user-friendly solution that helps teams follow approved processes, adhere to regulatory requirements, and manage tasks.

## Intel Components

- Intel® Core™ i5 processors
- Intel® Core™ i3 processors
- Intel® Distribution of OpenVINO™ toolkit

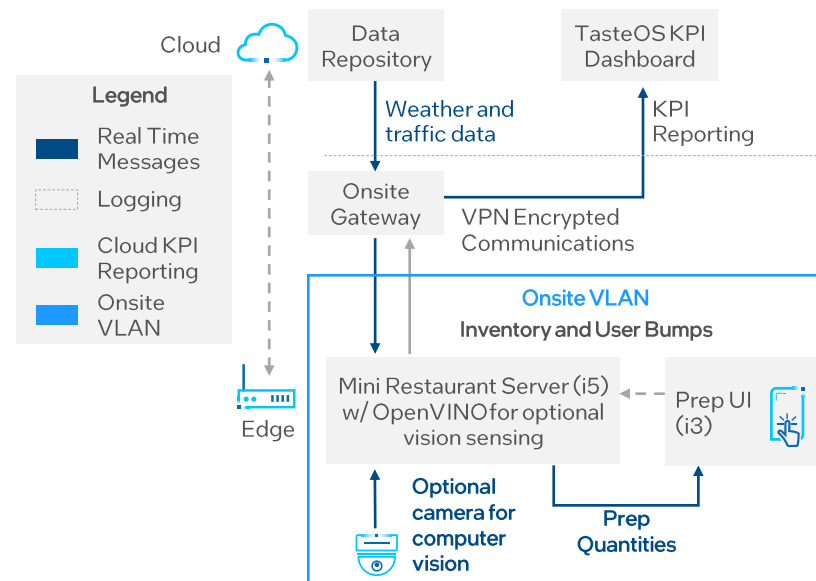

## Target Vertical:

Hospitality

## Secondary Verticals:

Retail, Partner Verticals

## Partner Designated Vertical:

Restaurant & Grocery

## Target Use Case:

Asset & Operations Optimization

## Secondary Vertical:

Logistics & Tracking

## Geo Availability

Americas, EMEA

## Sales Contact

[sales@precitaste.com](mailto:sales@precitaste.com)

## Solution Webpage

[PreciTaste Prep Assistant](#)

## Learn More

- How it works
- PreciTaste news
- Business case
- Customer story video

1. [Business Cases](#), PreciTaste, 2023. | 2. Case Study: AI-Driven Prep, PreciTaste, 2023.

# PROTO Hologram Powered by Wachter

## Solution Overview

Companies understand the importance of creating unique and powerful connections between their brands and customers. PROTO Hologram powered by Wachter delivers new, interactive ways to create those connections. Wachter deploys PROTO for retailers, entertainment, higher education, industrial, hospitals, and more to bring dynamic interaction to digital displays and transform the way customers virtually interact with companies. PROTO is an innovative display system for creating, managing, and distributing holographic content. It enables brands to beam their live and previously recorded content from a multimedia studio or mobile app. Then, the PROTO cloud beams the content to PROTO device locations up to thousands of miles away. End users can then interact with people via PROTO displays at those locations through telepresence that enables amazing and impactful guest experiences.

## Value Props

- Improve the customer experience** by transforming stores into immersive destinations that bring brands to real life with real-time, live connections that blur the lines between live and digital displays.
- Increase customer traffic, dwell time, and sales** with live and interactive digital displays that simultaneously deliver compelling content while also capturing shopper sentiment instantly at multiple locations.
- Enhance your physical and digital display strategy** with the ability to create, live stream or record, and display engaging content on PROTO devices at any time from anywhere on any mobile device.

## Kit Components

- Intel® Core™ i7 and i9 Processors
- Intel® RealSense™ Technologies

## Connection Diagram – Beaming

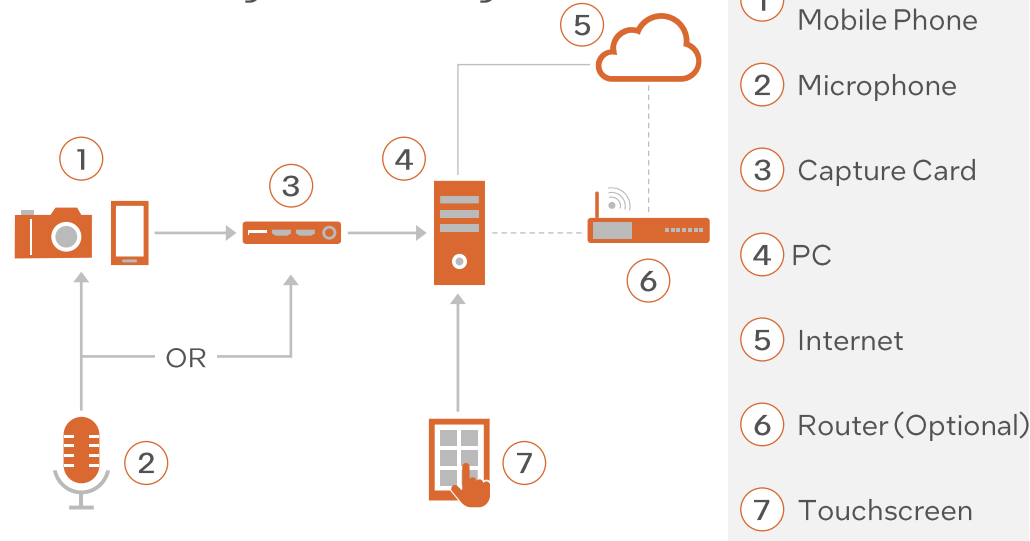

**Target Vertical:**  
Retail

**Secondary Verticals:**  
Education, Health and Life Sciences, Hospitality and Restaurants, Banking/Financial Services

**Target Use Case:**  
Interactive Media

**Secondary Use Cases:**  
Human Wellness Monitoring, Virtual Training, and Entertainment

**Geo Availability**  
North America

### Learn More

- [The Wachter PROTO Site](#)
- [The PROTO Website](#)
- [The Wachter Intel Solutions Marketplace Partner Page](#)



# Prowise Full Solution for Education

## Solution Overview

The Prowise Full Solution for Education offers a powerful interactive experience to the education industry. The 3-in-1 camera, touchscreen, and PC modules bring engagement into the classroom by providing a safe, collaborative, and active educational experience.

## Value Props

- Unlock a fun, educational, and healthy experience for students
- Bring experts into the classroom with video conferencing capabilities
- Protect personal data through components that comply with security and privacy standards

## Intel Components

- Intel® Core™ i5 processors
- Intel® RealSense™
- Intel® vPro™ and Unite™

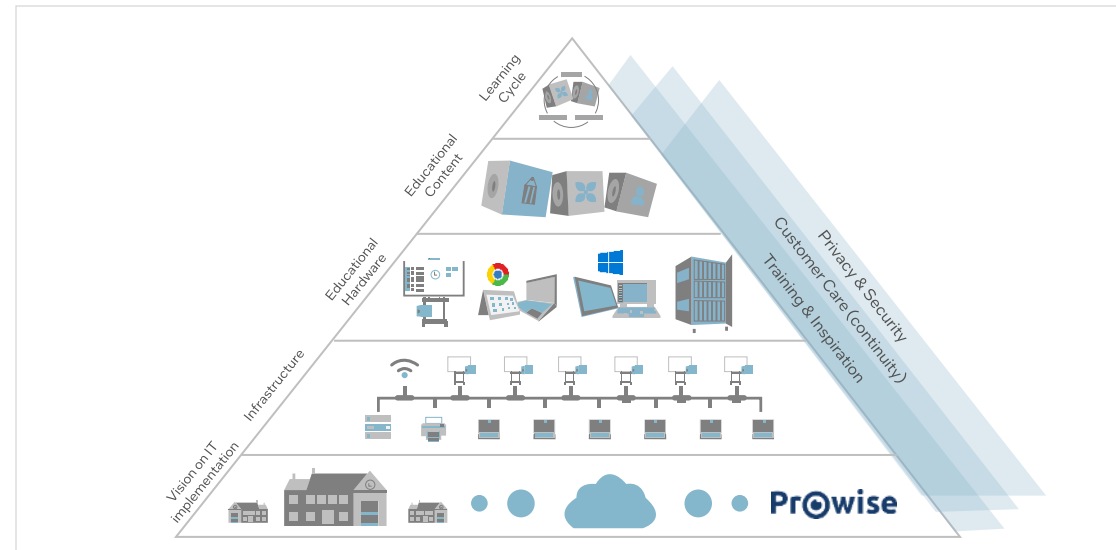

Target Vertical: Education

Target Use Case: Asset & Operations Optimization

Secondary Use Case: Interactive Media

Geo Availability  
North and South America

Learn More  
Prescriptive Data NANTUM solution website



# PT. Murni Solusindo Nusantara AI Powered Digital Public Information Display

## Solution Overview

PT. Murni Solusindo Nusantara's AI Powered Digital Public Display offers a digital signage solution that helps businesses provide visual displays that inform, engage, and entertain customers along with real-time data and analytics that provide insights into messaging efficacy, allowing administrators to optimize strategy. The solution provides built-in privacy protection for its audience detection technology by utilizing anonymous pattern detection algorithms that help ensure no images or video are recorded, and no personal information is collected.

## Value Props



Improve service quality by deploying effective messaging content based on customer engagement data insights



Streamline operations and information sharing protocols by managing content updates across multiple display locations from a centralized CMS



Increase profits through cross-sell and up-sell product offerings and services included in visual campaigns

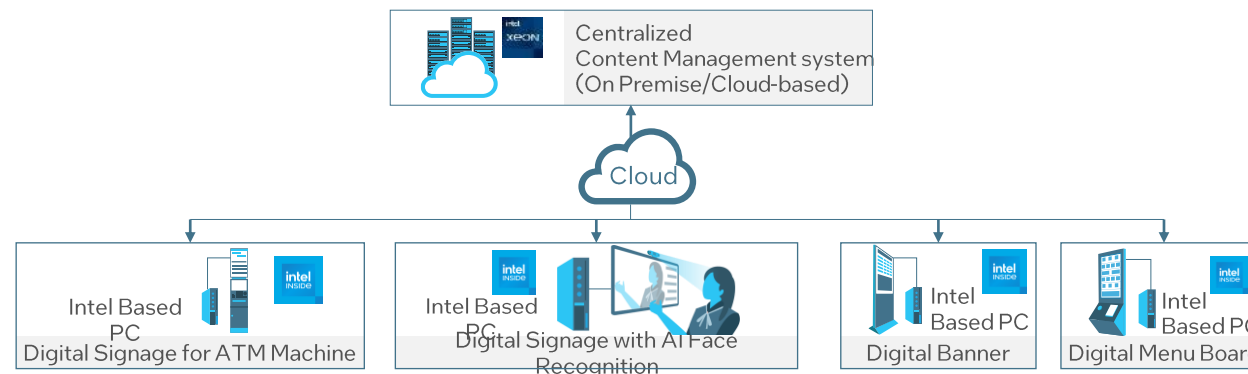

## Intel Components

- Intel® Distribution of OpenVINO™ toolkit
- Intel® NUC
- Intel® Core™ i5 Processors
- Intel® Core™ i3 Processors

**Target Vertical:**  
Banking/Financial Services

**Secondary Verticals:**  
Education, Health and Life Sciences, Hospitality and Restaurants, Retail, Transportation and Warehousing, Government

**Target Use Case:**  
Interactive Media

**Geo Availability**  
APJ



**Learn More**  
Digital Public Information Display Product Page

# Prox Systems Co., Ltd. Restaurant Smart Service Solution

## Solution Overview

In the restaurant and hospitality industry, labor shortages and an increasing customer preference for using contactless technology services have increased the demand for automated, self-service digital solutions. The Prox Restaurant Smart Service Solution helps restaurants facilitate operational efficiency with automated technology from self-ordering, touchless payments, and kitchen order management, to customer pick-up. The solution also provides powerful data insights to help restaurants gain a deeper understanding of their market and a cloud-based platform to help monitor their hardware devices remotely. Ultimately, the Prox solution provides restaurants with all the tools needed to improve service and gain a competitive advantage.

## Value Props

-  **Increase operational efficiency** by streamlining ordering, payment, and preparation processes with an automated and comprehensive technology
-  **Improve customer satisfaction** by leveraging insights to help improve your services, on top of providing a faster and safer experience
-  **Facilitate IT management** with a built-in, cloud-based platform service that enables easy remote device management and quick troubleshooting

## Kit Components

- Intel® Celeron® processors
- Intel® Core™ i3 processors
- Intel® Core™ i5 processors

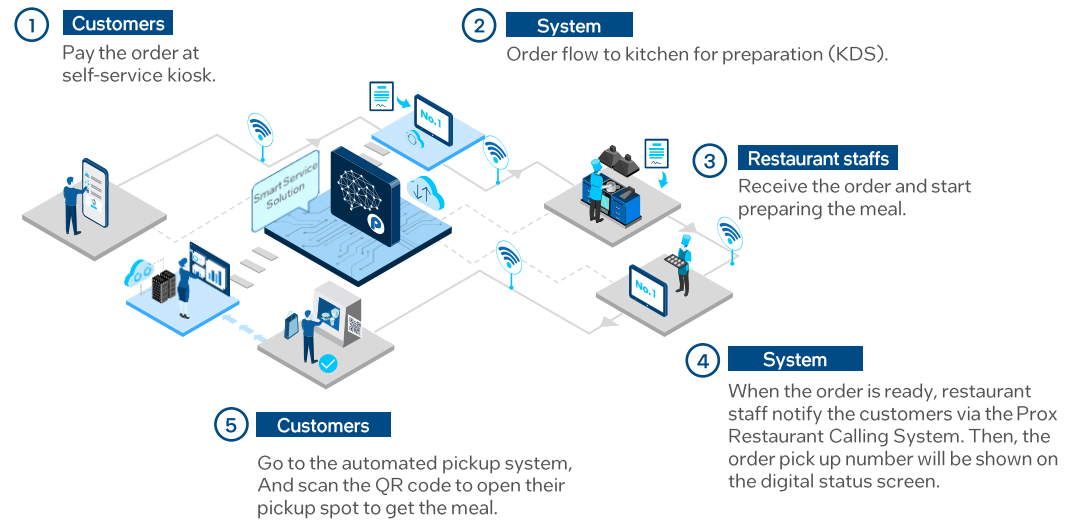

**Target Vertical:**  
Hospitality and Restaurants

**Secondary Vertical:**  
Retail

**Target Use Case:**  
Interactive Media

**Geo Availability**  
Asia Pacific, Japan, USA, Germany, Spain

- Learn More**
- [Protech Systems \(Prox\) Website](#)
  - [Solution Webpage](#)





# Pyramid Computer Essentry Visitor Verification

## Solution Overview

The Pyramid Computer Essentry Visitor Verification solution solves the dilemma of unverified access to critical facilities with an efficient and streamlined process leveraging a self-service kiosk. Providing secure and easy-to-use technology, customers are able to eliminate human-service and reduce cost in a variety of industries.

## Value Props



Reduce reception operation costs by eliminating unnecessary time and resources spent on operation costs



Improve the visitor management processing time through fully automated kiosks



Safeguard your facilities, ideas and intellectual properties by leveraging biometric identification to verify and authenticate visitors or employees

## Intel Components

- Intel® Core™ i5 processors
- Intel® RealSense™ Technologies

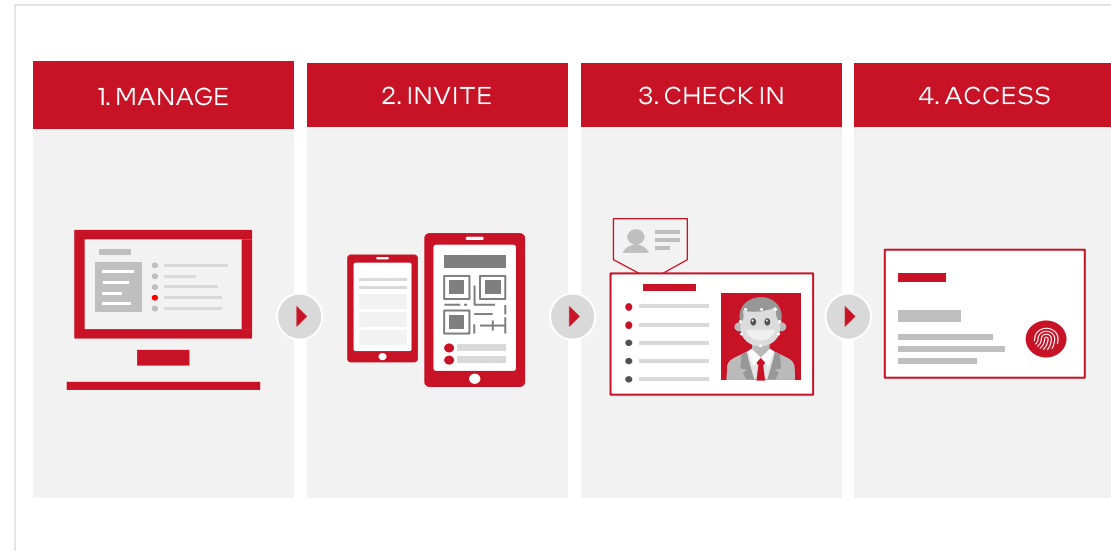

Target Vertical: Health & Life Sciences

Secondary Verticals:  
Chemicals & Pharmaceuticals,  
Datacenters, Hospitality,  
Defense, Transportation,  
Enterprise

Target Use Case: Logistics & Tracking

Secondary Use Cases:  
Visitor Management & Access Control, Situational Monitoring, Security

Geo Availability  
Europe and North America

## Learn More

- [essentry website](#)
- [Pyramid Computer website](#)





# Pyramid Computer Magic Mirror

## Solution Overview

The Pyramid Computer Magic Mirror gives retailers the chance to create a more immersive shopping experience for their customers. Offering an interactive display that functions both as a mirror for trying on items and a touchscreen for exploring products, customers are presented with a more personalized and engaging shopping experience

## Value Props

- Increase customer engagement with cutting-edge technology that cultivates an enhanced and more personalized shopping experience
- Increase sales through an interactive display that presents customers with product options and availability
- Improve operational efficiency by gaining insights into consumer purchasing habits and product ROI

## Intel Components

- Intel® Core™ i5
- Intel® Q170 Chipset

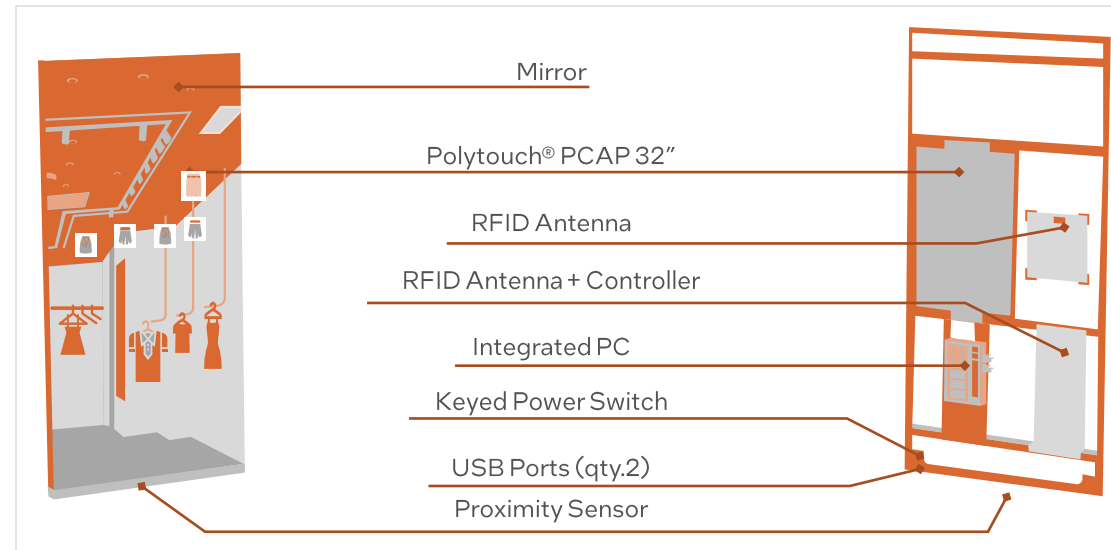

Target Vertical: [Retail](#)

Target Use Case: [Interactive Media](#)

Secondary Use Case: [Logistics & Tracking](#)

Geo Availability

North America and Europe

Learn More

[Pyramid Computer website](#)

# Pyramid Computer Restaurant Ordering Kiosk

[Back to Hospitality Solutions](#)

[Back to Interactive Media Use Cases](#)



## Solution Overview

The Pyramid Computer Restaurant Ordering Kiosk is a modular kiosk solution for ordering and self-checkout. Complimented by the Menu Omnichannel Ecosystem, these kiosks offer a comprehensive ordering system to improve contactless purchases for safer restaurant practices

## Value Props



Streamline and enhance restaurant operations with contactless ordering for safer and more efficient practices



Improve sales and ROI with a kiosk that reduces workflow costs while enhancing customer experience and offering a platform for more sales opportunities



Enhance public image by improving social distancing practices and ensuring customer safety

## Intel Components

- Intel® Core™ i5 Processors
- Intel® RealSense™ Technologies

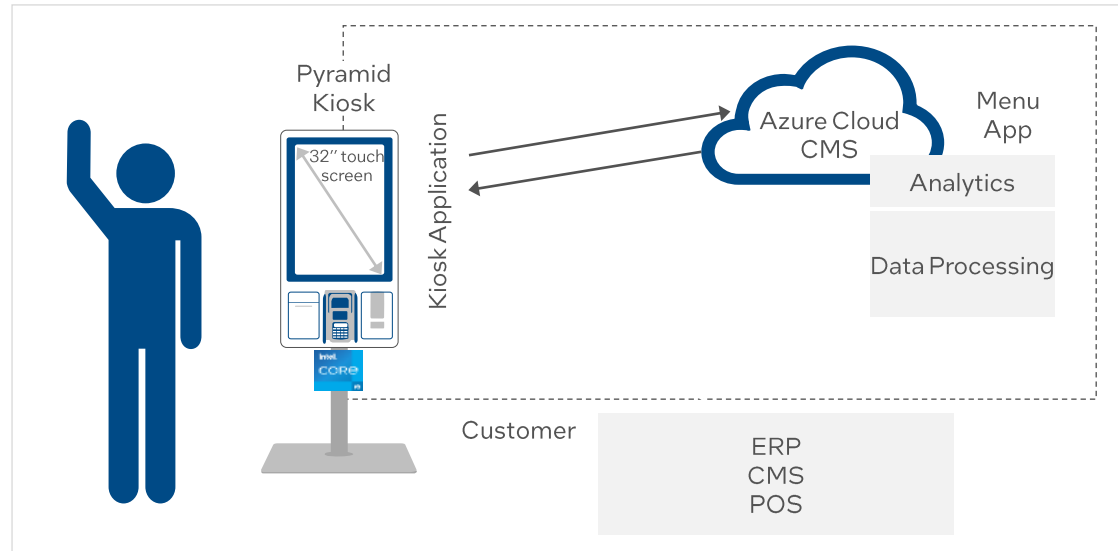

Target Vertical: Hospitality

Target Use Case: Interactive Media

Geo Availability  
Globally

### Learn More

- [Pyramid Computer website](#)
- [Menu Website](#)
- [Menu Ecosystem Video](#)



Back to Health & Life Sciences Solutions

Back to Situational Monitoring Use Cases





# Qisda ER Dashboard AIoT Information Platform

## Solution Overview

Acute care ER and ICU healthcare teams experience ongoing challenges with getting access to timely, easily consumable information from patient monitoring systems, while patients struggle with long, indefinite wait times. The Qisda ER Dashboard AIoT Information Platform solves these problems by gathering essential patient information from across hospital information systems (HIS) and medical devices, intelligently displaying relevant data for convenient medical staff monitoring, and actively alerting staff about critical indicators. The solution makes tracking patient queue and consultation status more efficient, supports optimal medical decision-making for timely care, and helps to ensure patients do not suffer unnecessarily long wait times.

## Value Props

-  **Streamline access to real-time patient information** with a platform that aggregates important data from hospital systems and devices and actively sends alerts on test progress, blood test values, in bed/ empty bed status, examination classification, critical illness notes, respirator use, medical orders, and more
-  **Enhance patient experiences** by reducing patient wait times and improving quality of care with a solution that enables more rapid, effective decision-making by healthcare teams via intelligent display of critical patient data
-  **Decrease pressures on medical staff** by reducing demands for manual data storage, retrieval, and communication for medical staff and patients across hospital environments and departments

## Kit Components

- Intel® Core™ Processors
- Intel® Xeon® Processors

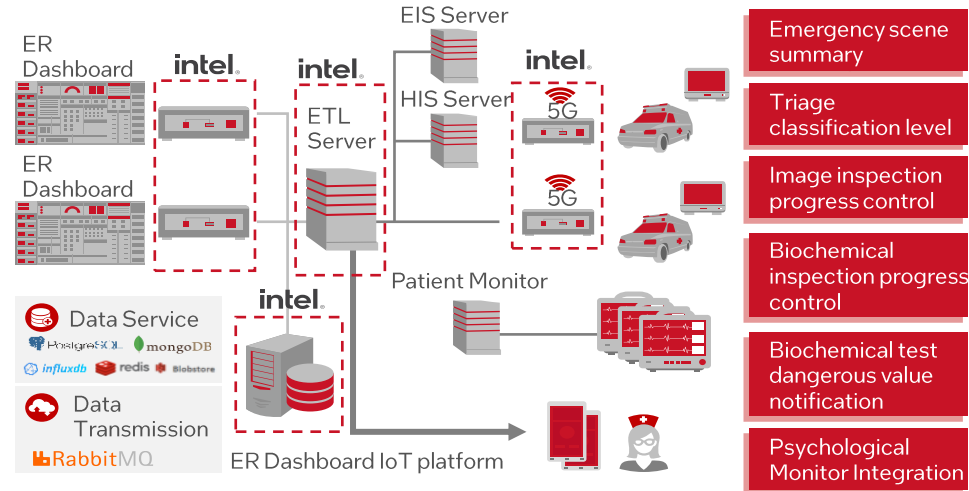

Target Vertical:  
Health & Life Sciences

Target Use Case:  
Situational Monitoring

Geo Availability  
APJ

### Learn More

- [Solution Webpage](#)
- [Intel Solutions Marketplace](#)



Q-Net Security

# Q-Net Security – Cybersecurity Hardware Solutions

Back to Energy Solutions

Back to Other Use Cases



## Solution Overview

Offering a new class of security solution, the Q-Net Security (QNS) Cybersecurity Hardware Security (HardSec) Solutions can lower the risk of cyberattack with an easy to drop-in, no-maintenance solution. The QNS secure network overlay is a powerful and cost-effective way to protect critical infrastructure from cyberattacks and prevent cyber intrusion for both legacy heterogeneous networks and greenfield networks.

## Value Props



Futureproof operations with a quantum-compute resistant silicon-based solution that provides some of the strongest drop-in security available



Integrate seamlessly with any network by plugging in a Q-Box to secure an endpoint



Simplify management by eliminating the need for maintenance with a solution that requires no endpoint agents or software updates

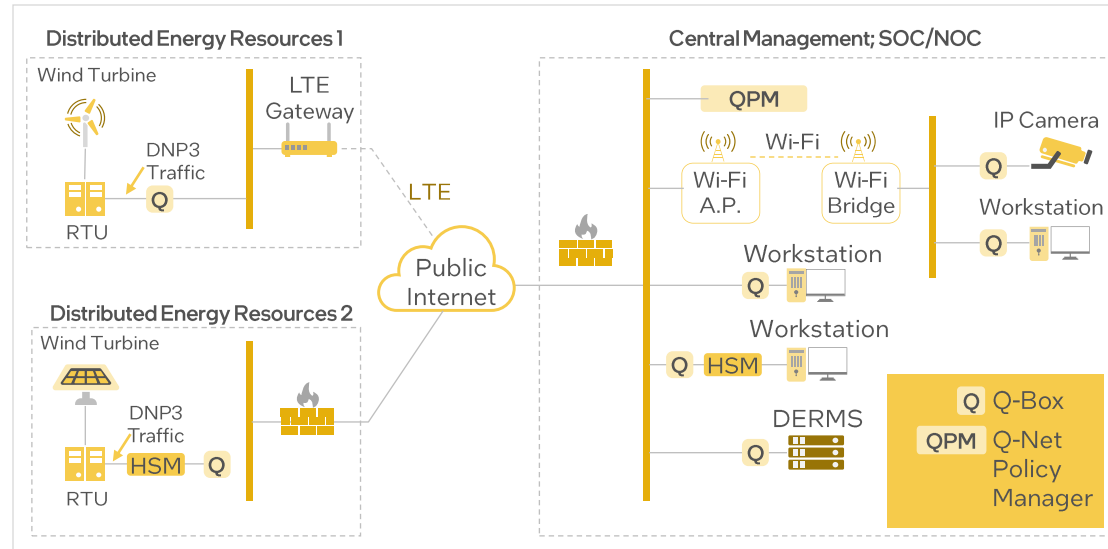

## Intel Components

- Intel® FPGA
- Intel® Celeron® Processors

**Target Vertical:** Electric Utilities; Water/Wastewater; O&G; Energy

**Secondary Verticals:** Banking/Financial Services; Gaming & Entertainment; Government; Manufacturing; Transportation

**Target Use Case:** Secure Critical Infrastructure; Other

**Geo Availability**  
North America, LATAM, EMEA and APAC

**Learn More**  
[Q-Net Security Website](#)

# Qualitas Technologies EagleEye Platform

## Solution Overview

The Qualitas EagleEye Platform (QEP) is a solution development engine backed by deep learning which enables customers to quickly develop powerful visual inspection solutions for industrial use cases. The QEP provides companies the ability to harness AI to ensure high quality production, catch defects and alert appropriate staff in real-time, and gain valuable insights.

## Value Props

- Improve inspection accuracy by improving error detection rates and reducing false positive rates with Qualitas' fine-tuning workflow and powerful accuracy verification
- Reduce costs with cost-optimized image acquisition by minimizing installation complexity and delays, through decreased solution development and model training time
- Deploy simply and effectively with a complete end-to-end platform that includes the hardware, software, and cloud applications needed to get started quickly

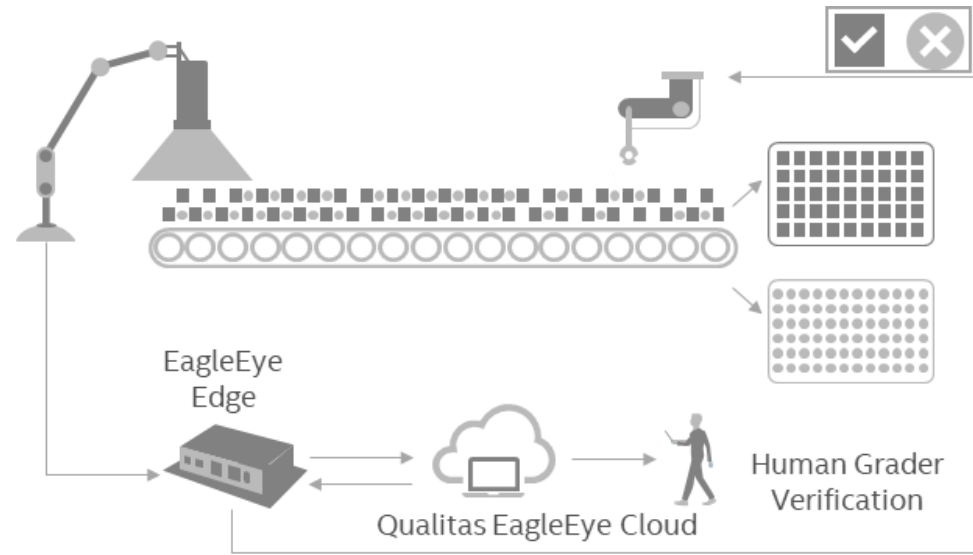

## Intel Components

- Intel® Xeon® Processors
- Intel® Neural Compute Stick
- Intel® Movidius™ VPUs
- Intel® Distribution of OpenVINO™ toolkit
- Intel® Core™ i3, i5, i7, and i9 Processors

**Target Vertical:** [Manufacturing](#)

**Secondary Verticals:** [Industrial](#)

**Target Use Case:** [Product Inspection](#)

**Secondary Use Case:** [Logistics & Tracking](#)

**Geo Availability**  
 Brazil, Canada, Mexico, United States, Other Americas, Australia/New Zealand, India, Japan, South Korea, PRC, Taiwan, Germany, Israel, Middle East, North Africa, and Turkey, Russia, Sub-Saharan Africa, UK

**Learn More**

- [Qualitas Technology Website](#)
- [Qualitas EagleEye Platform Solution Page](#)
- [Qualitas EagleEye Platform Case Studies](#)

# Quanergy Flow Management

## Solution Overview

Quanergy's Flow Management solution uses LiDAR technology to provide a modular, scalable, and advanced perception platform that enables real-time analysis for people counting, object detection, classification, tracking, and more. It is designed to address a wide range of applications more effectively than traditional security systems.

## Value Props



Increase operational efficiency with accurate, real-time, 3D images and high resolution, reducing false alarms and the costs of security personnel



Enhance security with a solution that enables powerful tools for security and analytics applications and uses sensors that operate in every lighting condition



Help improve performance with LiDAR sensors which provide high longevity and cost efficiency

## Intel Components

- Intel® Celeron® processors
- Intel® Xeon® processors
- Intel® Core™ i7 processors

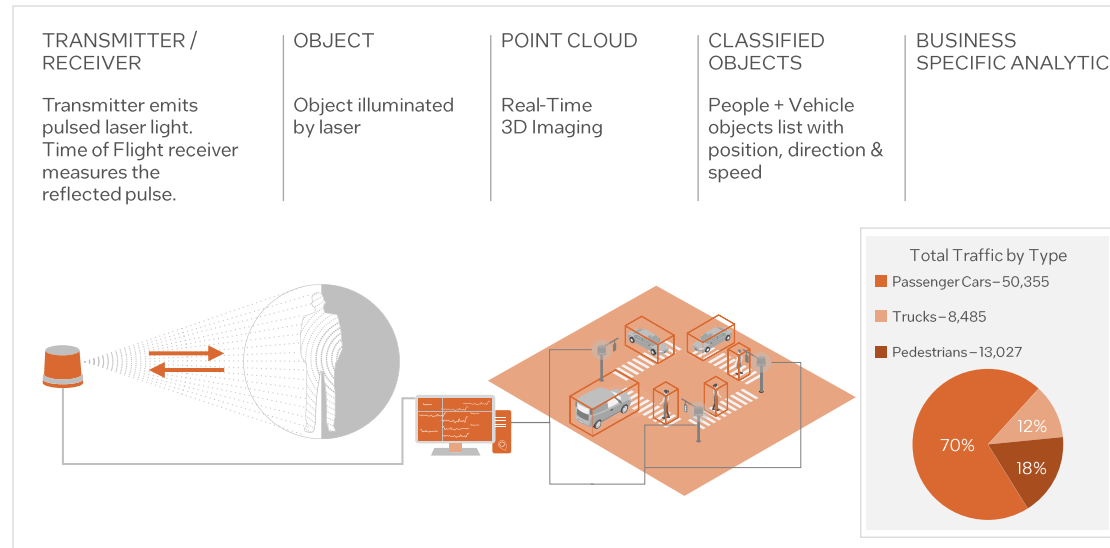

**Target Vertical:** Retail  
**Secondary Verticals:** Agriculture; Banking/ Financial Services; Education; Energy; Gaming & Entertainment; Government; Hospitality; Manufacturing; Transportation

**Target Use Case:** Asset and Operations Optimization  
**Secondary Use Cases:** Control Optimization & Autonomy; Environment Monitoring; Logistics & Tracking; Situational Monitoring

**Geo Availability**  
 Globally

### Learn More

- [Quanergy | LiDAR Sensors and Smart Sensing Solutions](#)
- [Blog - Quanergy](#)
- [Contact Quanergy](#)



# Relimetrics AI-Based QA Automation System for Electronics Assembly

## Solution Overview

A closed-loop optical quality control system using AI-based video analytics in real-time at the edge that automates and digitizes visual inspections in-line, creating full traceability of quality in all stages of production

## Value Props



Maximize operational efficiency with a solution that fully digitizes quality audits



Improve QA accuracy and detect product defects instantaneously



Deploy easily as the solution can be rapidly integrated with existing infrastructure

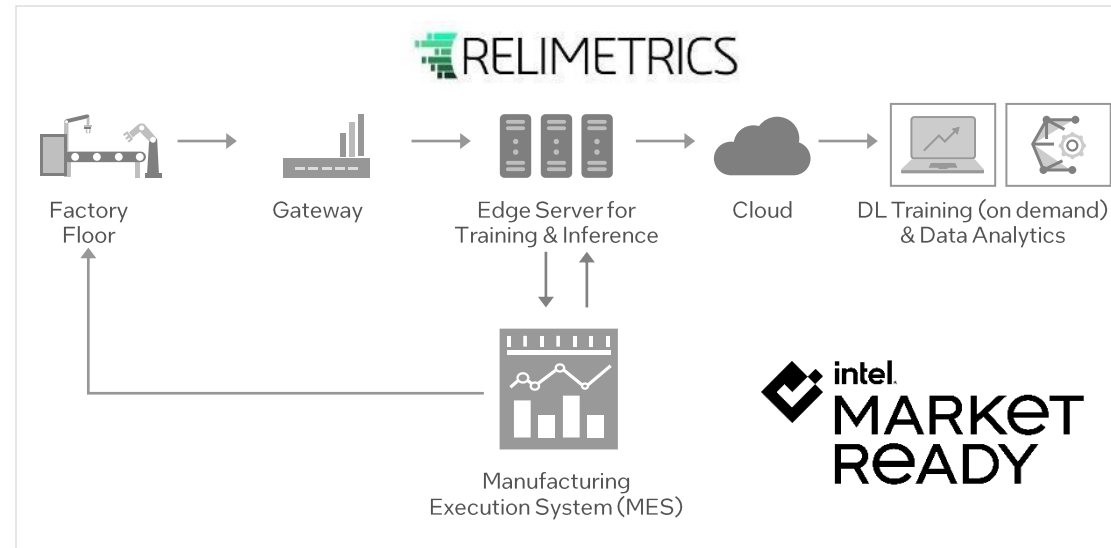

Target Vertical:  
Manufacturing

Target Use Case: Product Inspection

## Geo Availability

Available in USA, EMEA, and APJ

## Learn More

- [The Relimetrics official website](#)
- [The Relimetrics server quality audit system video](#)

## Intel Components

- Intel® Xeon® Processors
- Intel® Core™ i7 Processors
- Intel® Distribution of OpenVINO™ Toolkit
- Intel® Movidius™ VPUs



# RF Controls Overhead CS Smart Antennas for Battery-Free RFID Based Real-Time Location

## Solution Overview

The RF Controls solution is an innovative and easy-to-install all-in-one RFID reader and bi-directional steerable phased array antenna. It delivers 2D or 3D pinpoint locational accuracy via a continuous stream of data to identify, locate, and track existing low-cost battery-free RFID tags. The solution enables a digital twin to bridge the supply chain IoT gap while reducing human error, delays, and inefficiency.

## Value Props



Increase asset productivity by gaining insights into the operations of your warehouse inventory, equipment, people, and processes



Improve inventory management and loss prevention by monitoring in real-time products, visualizing aging stock dwell time, and more



Achieve higher ROIs by increasing accuracy of tasks and product movements and quickly identifying errors, exceptions, compliance and employee training

## Intel Components

Intel® NUC

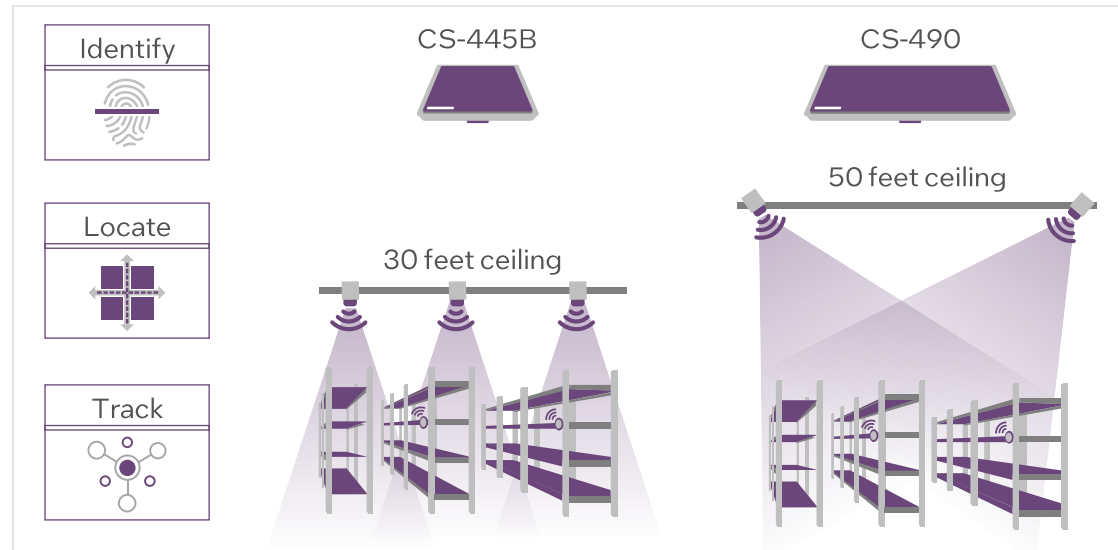

**Target Vertical:**  
Transportation

**Secondary Verticals:**  
Logistics & Smart Warehouse; Smart Factory, Freight, Retail Store & Distribution (POS + EAS), Returnable Transport Items, Cross-Docking

**Target Use Case:** Asset & Operations Optimization

**Secondary Use Cases:** Control Optimization & Autonomy; Environment Monitoring; Interactive Media; Logistics & Tracking; Situational Monitoring

### Geo Availability

Available in the United States, United Kingdom, Canada, Mexico, Europe, India, and Australia

### Learn More

- [RF Controls Website](#)
- [RF Controls Product Demo](#)



# RonPos - OnPrem Manageability System for Fuel Convenience Stores

## Solution Overview

The RonPos OnPrem Manageability System for Fuel Convenience Stores solution is a cloud-based Point of Sale solution fuel convenience store retailers to provide better customer service and experiences and stay competitive in an evolving market impacted by a worldwide lockdown and the rising popularity of electric vehicles. The solution allows gas station and c-store operators to gain better business insights and manage inventories, sales reports, cash flow, customer purchase trends, and more in one open hardware platform with minimal support costs.

## Value Props



**Enhance user experience** and help improve customer retention with an easy-to-use, highly-intuitive POS system that integrates seamlessly to systems for payment, loyalty rewards, and other features.



**Low relative total cost of ownership** with a hardware-agnostic platform that does not require software licenses or large upfront CAPEX

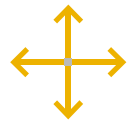

**Scale without disruption** by adding more POS and sales terminals easily via the compact RONPOS HUB as needed to support different use cases at the fuel station

## Intel Components

- Intel® NUC
- Intel® Core™ i5 processors

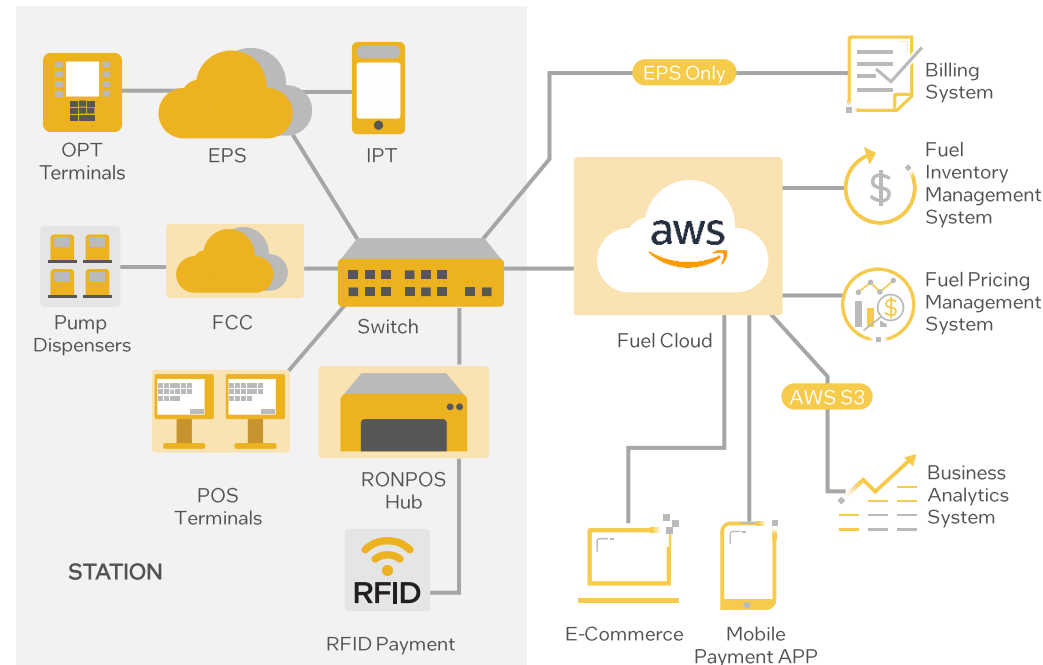

**Target Vertical:**  
Energy

**Secondary Vertical:**  
Retail

**Target Use Case:**  
Asset & Operations Optimization

**Secondary Use Cases:**  
Control Optimization & Autonomy, Logistics & Tracking

**Geo Availability:**  
APJ, Americas, EMEA

**Learn More:**

- [RONPOS Solution Website](#)



# Runkong Smart Hospital Kiosk

[Back to Health & Life Sciences Solutions](#)

[Back to Interactive Media Use Cases](#)



## Solution Overview

This solution is a highly efficient anti-epidemic medical self-service terminal that improves the way hospitals deliver distributed care. The smart hospital kiosk was deployed within the world's largest hospital with more than 10,000 beds, winning an Asian Management Gold Award.

## Value Props



Minimize the spread of diseases through body temperature detection and ultraviolet disinfection



Improve worker safety and productivity with a self-service kiosk for visitors that allows healthcare staff to avoid contact and prioritize core responsibilities



Enhance patient care by using management systems to support optimal care delivery

## Intel Components

Intel® Core™ i5-6500

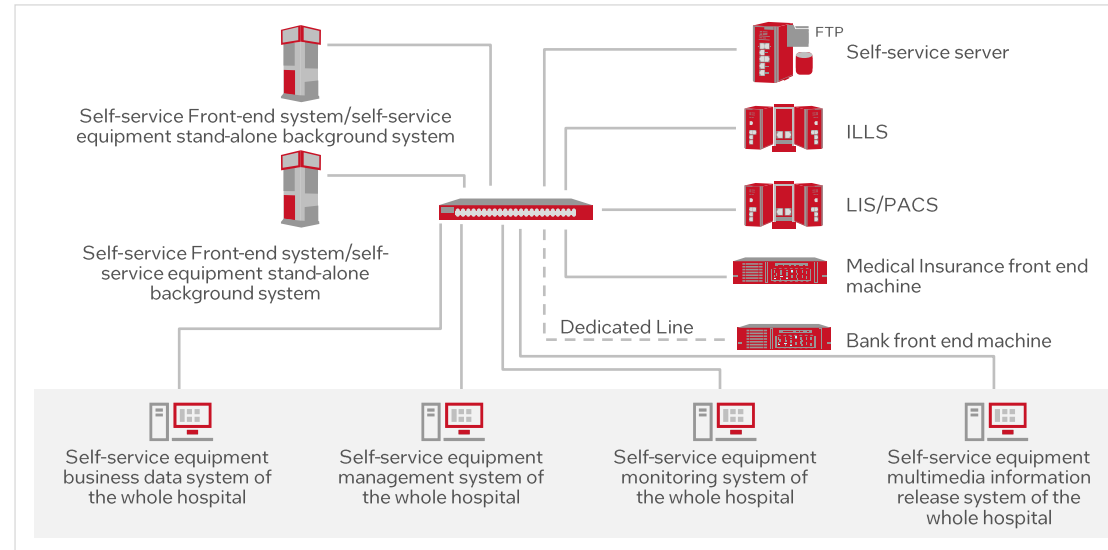

**Target Vertical:** [Health & Life Sciences](#)

**Secondary Verticals:** [Retail](#), [Hospitality](#), [Government](#)

**Target Use Case:** [Interactive Media](#)

**Secondary Use Case:** [Situational Monitoring](#)

**Geo Availability**  
Globally

### Learn More

- [Runkong Intel Solutions Marketplace](#)



# Schoolnet India Limited K-Class Powered by K-Yan

## Solution Overview

Schoolnet K-Class Powered by K-Yan is an end-to-end, portable, and Plug-n-Play digital smart classroom solution. Utilizing a blended learning approach with traditional classroom and multimedia technology, the Schoolnet K-Yan converts any surface to an interactive board using IR technology pre-loaded with digital curriculum content for many different subjects for a more engaging and interactive educational environment.

## Value Props



Enhance learning experiences with a solution that utilizes cutting edge technology to create a more engaging learning environment for students



Modernize educational environments through a solution that enables more connectivity and scalability as technology-based education continues to progress and develop



Reduce costs with a budgeted single unit, mobile device that can serve multiple locations and be used as a community computer

## Intel Components

Intel® Core™ i3, i5 and i7 Processors

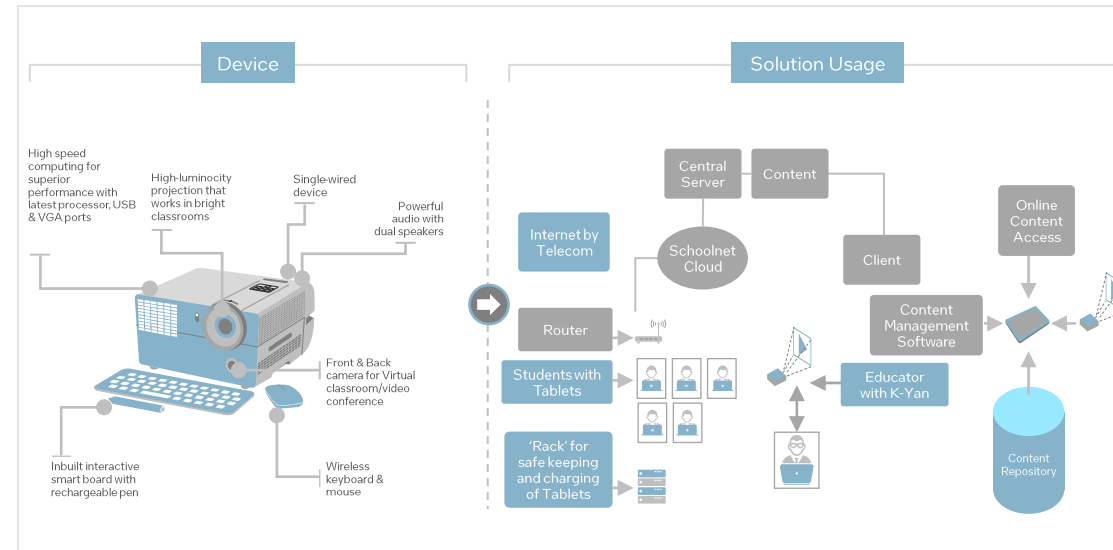

Target Vertical: Education  
 Secondary Verticals: Banking/Financial Services,  
Gaming & Entertainment,  
Government, Retail

Target Use Case:  
Interactive Media

Geo Availability  
 India, Middle East, North  
 Africa and Turkey, Sub-  
 Saharan Africa

## Learn More

- [Schoolnet Website](#)
- [Schoolnet K-Yan Webpage](#)

# ScreenVend Digital Retailing Solution

## Solution Overview

ScreenVend is an innovative, limitless aisle digital software solution for the pharmacy and retail industry based on ClicksiNBricks® technology. ScreenVend opens a new world in retail dynamics, bringing benefits of online shopping to the physical store by providing ease of use, relevance, and greater choice, in combination with instant fulfillment through digital shelves and robotics.

## Value Props

- Eliminate shrink** with a robotic system to reduce theft and stock loss, ensuring a more secure inventory
- Increase operational efficiency** by removing the need for manual tasks like restocking, and allowing more time for value-adding customer service
- Optimize for convenience** with instant product fulfillment through a combination of online technologies and robotics

## Kit Components

- Intel® Core™ i5 Processors
- Intel® NUC

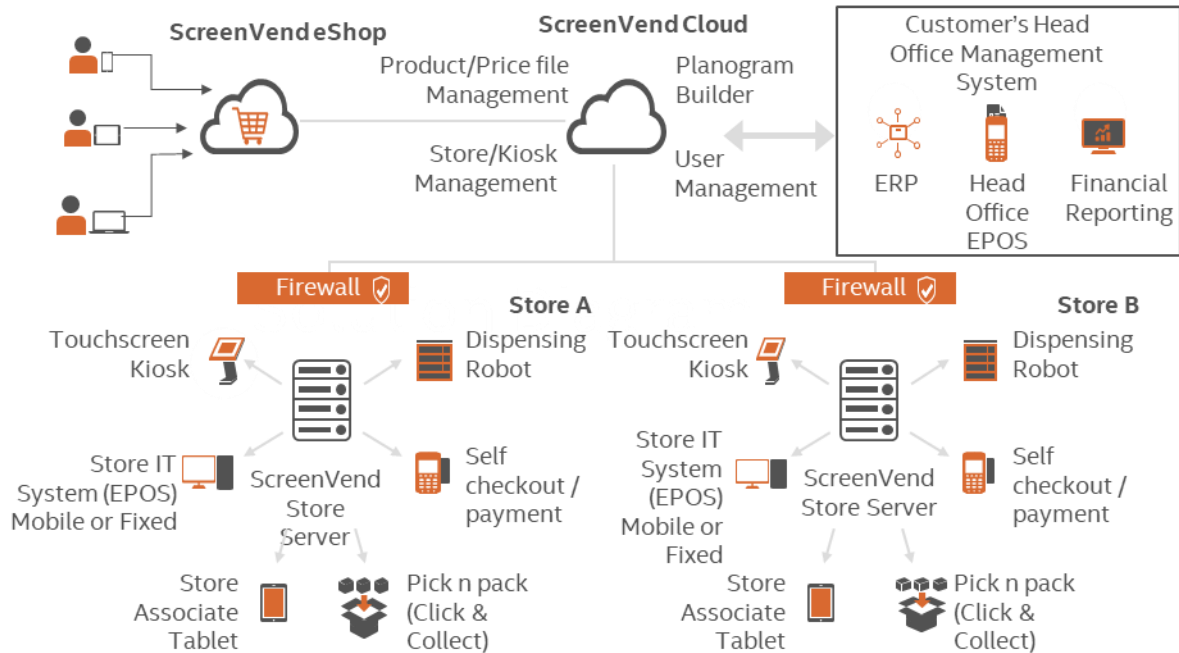

**Target Vertical:**  
Retail

**Secondary Vertical:**  
Transportation

**Target Use Case:**  
Interactive Media

**Secondary Use Cases:**  
Asset & Operations Optimization; Logistics & Tracking

**Geo Availability**  
Global

**Learn More**  
Screenvend.io website



# Seavo Kiosk Peripheral Management and USB Auto-Recovery

## Solution Overview

The Seavo Kiosk Peripheral Management and USB Auto-Recovery solution helps users detect and remotely fix peripheral failures in a timely manner, thereby significantly reducing device failure probability and maintenance costs. The solution is a motherboard and software package that can be directly integrated into kiosk system designs.

## Value Props

- Decrease failure rates and downtime, and provide users with more stable self-service support
- Reduce maintenance costs, and lower the frequency of on-site repair and maintenance with remote management capabilities
- Enhance kiosk versatility and offer a range of performance options for kiosk customers including quality visual applications

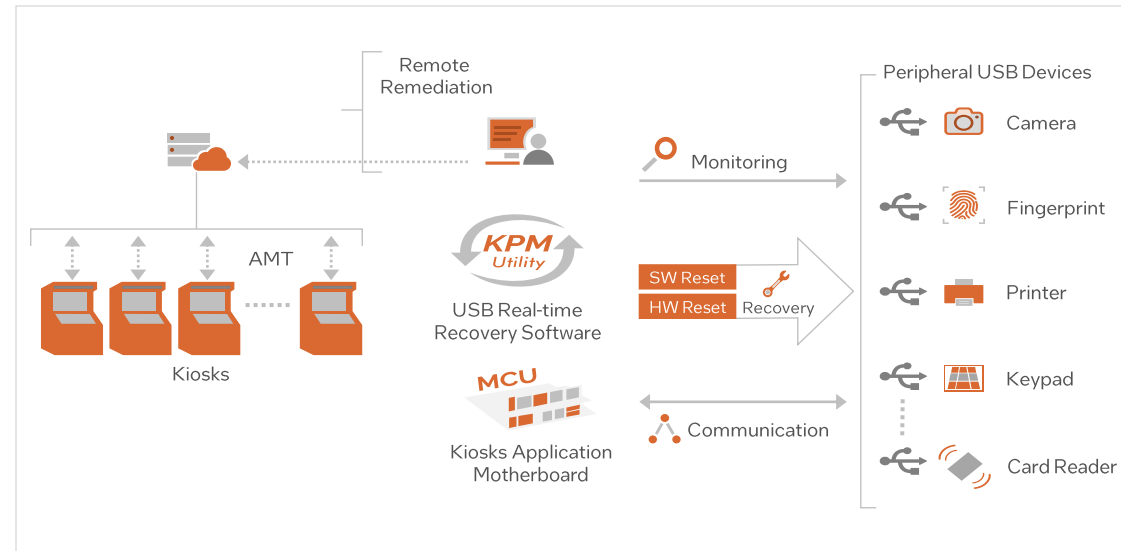

## Intel Components

- Intel® KPM Utility
- Intel® Core™ i5 processors
- Intel® Celeron® processors
- Intel® Core™ i3 processors
- Intel® Core™ i7 processors

Target Vertical: Retail

Secondary Verticals: Banking/Financial Services; Government; Health & Life Sciences; Hospitality

Target Use Case: Machine Condition Monitoring

Secondary Use Cases: Asset & Operations Optimization; Control Optimization & Autonomy

Geo Availability

South Korea, Taiwan and the People's Republic of China

Learn More

- Seavo - Intel® Solutions Marketplace
- Seavo Technology Website



# Sertek All-in-One AI NVR

## Solution Overview

All-in-One AI NVR is a video analytics solution that helps businesses better understand their customers by analyzing shopper behaviors in physical stores. This solution collects data from video cameras installed in stores and analyzes it using AI algorithms. The analyzed data provides the management team with insights into customer behaviors, such as how long customers stay in the store, which products they are interested in, and how they interface with products and the space. This information helps business owners optimize their store layout, develop display strategies, and create marketing initiatives that improve customer experience and drive sales.

## Value Props



Improve store layout with automatically generated insights on where customers move and loiter within the store



Enable targeted marketing with enhanced understanding of what type of products different demographic segments prefer



Enhance customer experience by recognizing regular customers and automatically generating online shopper profiles for customers

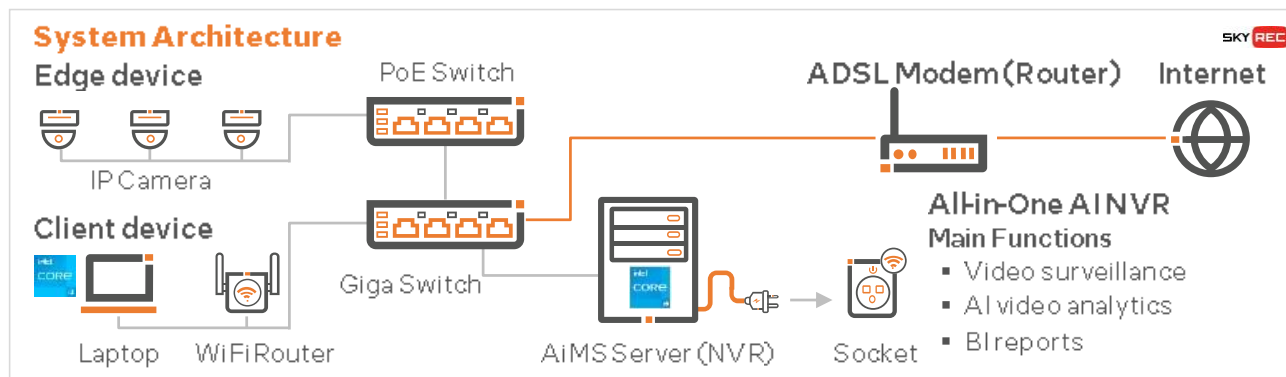

## Intel Components

- Intel® Core™ i3 processors
- Intel® Core™ i5 processors
- Intel® Core™ i7 processors

Target Vertical: Retail

Secondary Vertical: Education, Government, Hospitality and Restaurants, Manufacturing, Transportation and Warehousing

Target Use Case: Situational Monitoring

Geo Availability: APJ, Americas, EMEA, People's Republic of China

## Learn More

- [All-in-One AI NVR Solution Product Page](#)





# Sertek EZcon Smart Building System

## Solution Overview

Companies are continuously searching for ways to simplify their building management by automating environment control systems across all their disparate equipment. Sertek's EZcon Smart Building system helps businesses achieve this goal by integrating control applications onto one operational window and automating core functions. Integrated hardware and software enables end users to monitor and control their environments with a tap of a touchscreen. The system can regulate door locks, lights, indoor temperature, and more both from its mobile interface or via automatic decision making. For example, the system automatically closes blinds if sunlight exceeds 20,000 lux and turns off lights if no one is present in a room. The Smart Building System recognizes users and permits entry to approved people, saves energy by eliminating unnecessary usage, and monitors environments to ensure they are safe and protected from gas leaks or other hazards.

## Value Props

**Increases security** through the implementation of facial recognition to permit entry and remote control of locks and cameras

**Enhances safety and environmental monitoring** of air quality temperature, moisture, gas leaks and electrical failures, with the ability to immediately turn off gas lines or electrical circuits remotely

**Simplifies daily operations** by providing control of a house or offices appliances and switches via mobile app or mounted touch screen

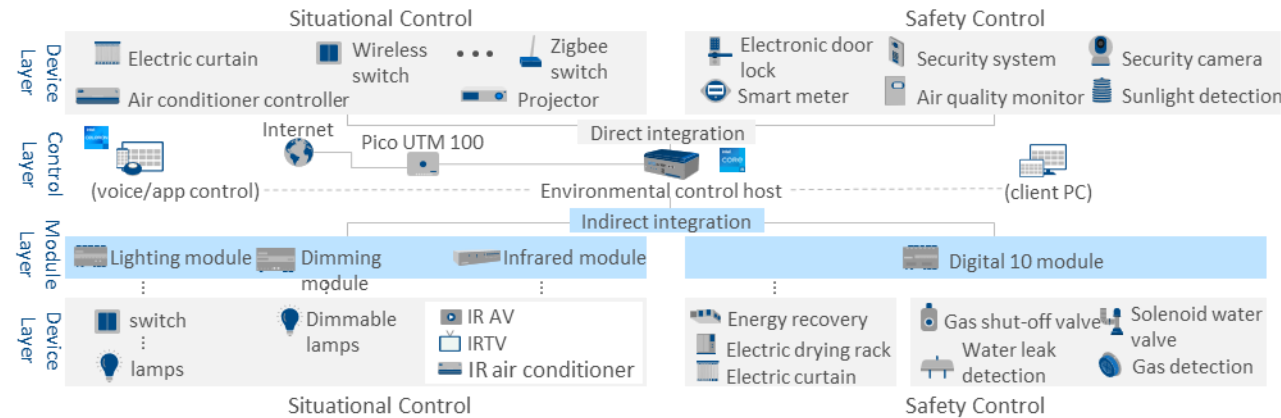

## Intel Components

- Intel® Core™ i5 Processors
- Intel® Celeron® Processors

**Target Vertical:**  
Hospitality

**Secondary Vertical:**  
Education, Retail

**Target Use Case:**  
Asset and Operations Optimization

**Geo Availability**  
Asia, Pacific and Japan

## Learn More

- [Solution: WPG IoT](#)
- [Solution Website \(wpgholdings.com\)](#)



# Seavo Real-Time Face Recognition Gate Access Control

## Solution Overview

The solution consists of a Face Recognition Host on an edge device connected to an IP Camera that gathers facial images. The Face Recognition Host enables real-time facial detection and identification at the network edge and supports gate access control and preemptive threat warnings.

## Value Props



Decrease overhead by reducing labor costs and eliminating redundancies



Streamline security with smart, connected technologies automating safety procedures



Enhance performance by integrating the solution into current systems at scale

## Intel Components

- Intel® Xeon®
- Intel® HD graphics
- Intel® Core™ i5 and i7
- IP Telephoto HD Camera
- Real-Time Face Recognition program
- Unified Management web system

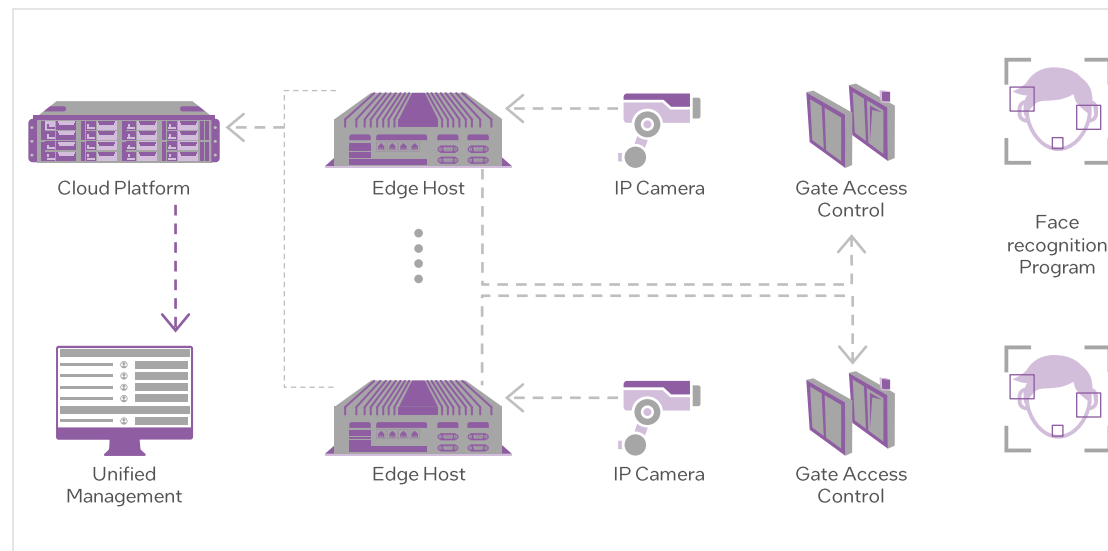

## Target Vertical:

Government

Secondary Verticals: Retail, Banking/Financial Services, Hospitality, Education, Health & Life Sciences

## Target Use Case:

Situational Monitoring

Secondary Use Cases: Product Inspection

## Geo Availability

China

## Learn More

- [Seavo Real-Time Face Recognition Gate Access Control solution brief](#)
- [Seavo Real-Time Face Recognition Gate Access Control product webpage](#)





# Sewio Real-Time Location System

## Solution Overview

On a factory floor, there are numerous moving parts – from work-in-progress material and personnel to machinery and vehicles. Having poor visibility into high-traffic zones lead to bottlenecks, delays, system downtimes, and even workplace accidents. Implementing Sewio’s Real Time Location System (RTLS), a precise indoor tracking system that uses Ultra-wideband (UWB) technology to help manufacturers track the movements of material and other assets on the factory floor with up to 30 cm accuracy<sup>1</sup>. By leveraging this accuracy, Sewio RTLS can help generate key actionable insights, automate mission-critical safety workflows, optimize factory floor movement, and improve factory floor operational efficiency, leading to an increased production output.

## Value Props

-  **Increase factory floor transparency** by gaining visibility into all on-site processes and generating actionable insights from real-time and historical data
-  **Optimize asset utilization** to improve Overall Equipment Effectiveness (OEE), while improving operational efficiency and production output
-  **Improve workplace safety** with tags on all personnel, machinery, and vehicles to identify potential hazards and prevent accidents

## Intel Components

- Intel® Xeon® processors

1. [Sewio RTLS Webpage](#)

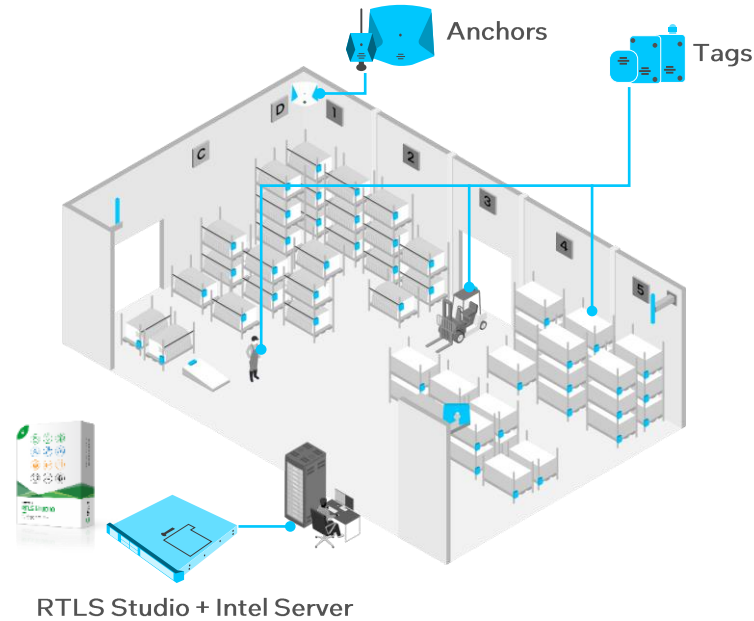

**Target Vertical:**  
Manufacturing

**Secondary Verticals:**  
Retail, Transportation and Warehousing

**Target Use Case:**  
Asset and Operations Optimization

**Secondary Use Cases:**  
Control Optimization & Autonomy, Logistics & Tracking, Machine Condition Monitoring, Situational Monitoring

**Geo Availability**  
Europe, Asia, Pacific, Americas, Middle East

**Learn More**  
▪ [Sewio RTLS](#)



# Shandong Extreme Vision Open Kitchen Solution

## Solution Overview

The Shandong Extreme Vision Open Kitchen Solution leverages artificial intelligence to automatically analyze images from cameras located in food production sites and generates real-time alerts when an issue or protocol breach is detected. Incidents/breaches can include employees not wearing proper protective equipment, employees smoking, vermin detected, or any number of additional customized events. The solution also keeps all recordings so managers can implement data-driven insights to improve food production processes and help clarify employee responsibilities.

## Value Props



**Improve operational efficiency** by leveraging AI to automate video analysis tasks and the sending of notification alerts to kitchen supervisors to increase monitoring efficacy, decrease human error, and improve food production efficiency.



**Increase consumer trust** by helping ensure kitchen staff are properly adhering to food safety regulations, enabling customers to track the sources of their food, and ultimately improving the consistency of products.



**Reduce labor costs** by decreasing the number of supervisors needed to perform 24/7 monitoring of images collected from food production sites and providing data-driven insights so managers can implement more cost-effective practices.

## Intel Components

- Intel® Celeron® Processors
- Intel® Core™ i7 Processors
- Intel® Distribution of OpenVINO™ Toolkit

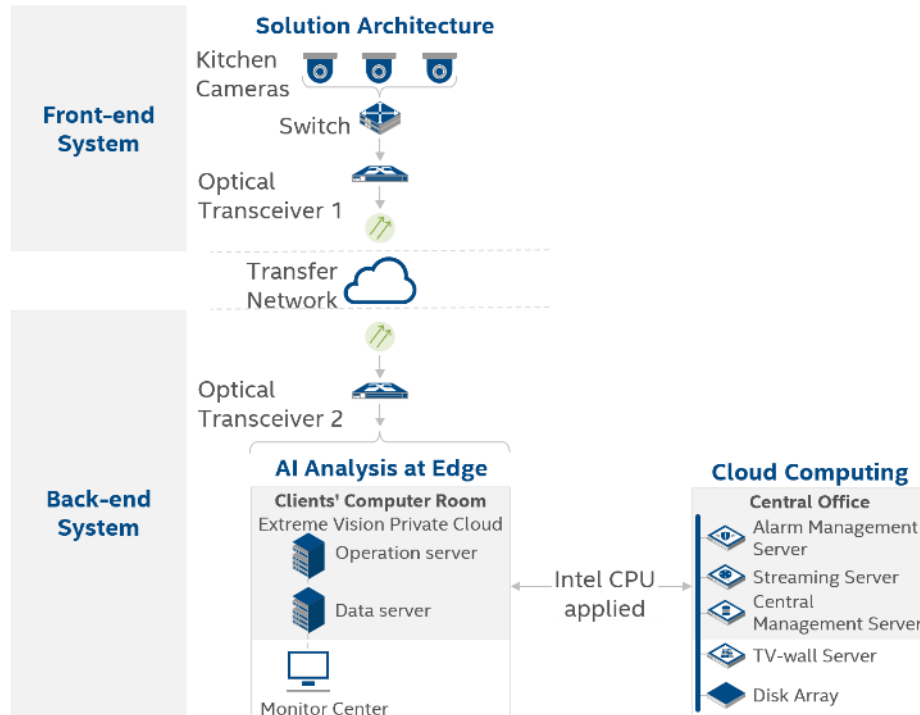

Target Vertical:  
Hospitality

Secondary Vertical:  
Retail

Target Use Case:  
Asset & Operations Management

Secondary Use Cases:  
Environmental Monitoring and Control Optimization & Autonomy

Geo Availability  
People's Republic of China

Learn More  
Shandong Extreme Vision Website

# Shandong Extreme Vision Co., Ltd. Smart Community AI Solution

## Solution Overview

The Smart Community AI Solution is a customizable, intelligent video management solution for smart community scenarios in different industries, such as manufacturing and government. Unlike traditional systems which rely on manual data management, the solution uses AI-based data governance and analysis to provide business process insights, empowering communities and businesses seeking to embrace smart operations.

## Value Props



**Optimize operational efficiency** by leveraging customizable AI algorithms to provide data-driven insights in a unified view for faster action



**Reduces labor burden** with an automated system that eliminates the need for manual data retrieval and management



**Help improve** with intelligent video analytics capabilities and real-time automatic alerts of incidents or improper or unsafe conduct

## Kit Components

- Intel® Core™ i5 Processors
- Intel® Core™ i7 Processors
- Intel® Distribution of OpenVINO™ toolkit

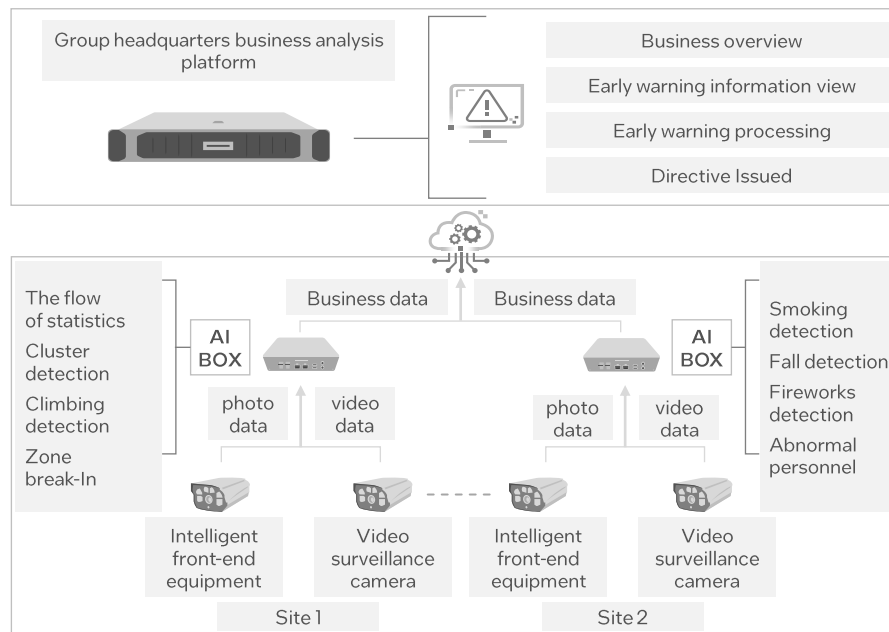

**Target Vertical:**  
Manufacturing

**Secondary Verticals:**  
Government, Hospitality and Restaurants, Retail

**Target Use Case:**  
Control Optimization & Autonomy

**Secondary Use Case:**  
Asset & Operations Optimization

**Geo Availability**  
PRC, APAJ

**Learn More**

- [Solution Webpage](#)

# Shandong Extreme Vision Co., Ltd. Smart Factory AI Solution

## Solution Overview

The Extreme Vision Smart Factory AI Solution is a multi-source monitoring system that provides real-time operational and safety monitoring. The solution uses AI computer vision technologies and algorithms, to achieve all-around and non-dead-angle monitoring and control of a factory's production floor.

## Value Props



**Improve workplace and worker safety** with a solution that helps track unsafe working behaviors and conditions



**Increase operational efficiency** with real-time actionable notifications from the production floor



**Reduce operational costs** by delegating hired personnel to other non-security and safety tasks

## Kit Components

- Intel® Core™ i3 Processors
- Intel® Core™ i7 Processors
- Intel® Xeon® Scalable Processors
- Intel® Distribution of OpenVINO™ toolkit
- Intel® Video AI Box
- Intel® Extension for Tensor Flow
- Intel® DevCloud

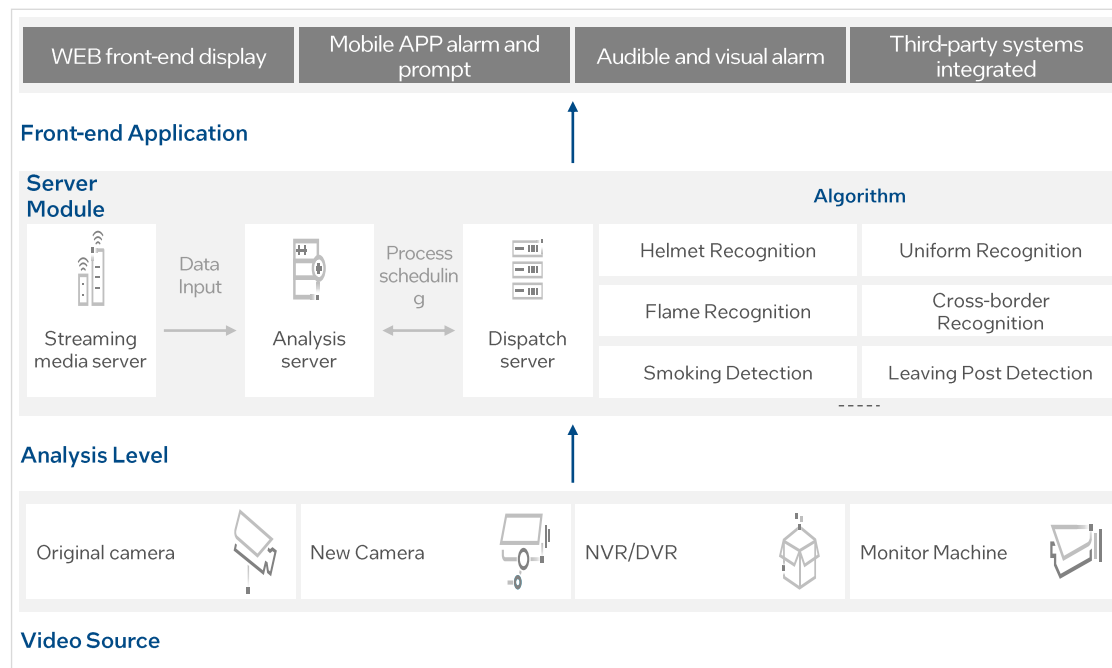

**Target Vertical:**  
Manufacturing

**Secondary Vertical:**  
Energy

**Target Use Case:**  
Control Optimization & Autonomy

**Secondary Use Case:**  
Energy Monitoring & Management

**Geo Availability**  
APAJ, PRC

## Learn More

- [Extreme Vision Website](#)
- [Extreme Vision - Algorithm Store](#)

# Shandong Extreme Vision Co., Ltd. Smart Retail AI Solution

## Solution Overview

The Shandong Extreme Vision Tech Smart Retail AI Solution, powered by Intel processors and optimized on The Intel® Distribution of OpenVINO™ Toolkit, is a computer vision AI solution that leverages retail stores camera systems to analyze visual data such as customer demographics, clothes preference, store hot spots, and more to deliver actionable insights that help store managers with strategic decision making.

## Value Props

 **Increase revenue** by driving sales with personalized shopping experiences utilizing customer data insights, such as product preferences

 **Improve in-store shopping experience** by leveraging insights to optimize store layouts and inventory to meet customer demand

 **Optimize store management** by fine-tuning processes and maximizing employee productivity with store and staff management data

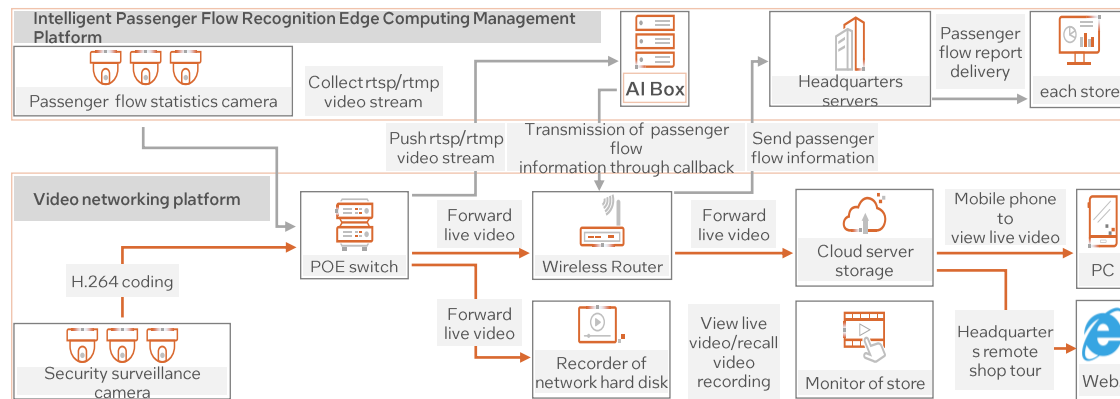

**Target Vertical:**  
Retail

**Secondary Vertical:**  
Transportation and Warehousing

**Target Use Case:**  
Control Optimization & Autonomy

**Secondary Use Case:**  
Logistics & Tracking

**Geo Availability**  
PRC, APAJ

## Learn More

- [Extreme Vision Website](#)
- [Extreme Vision - Algorithm Store](#)

## Kit Components

- Intel® Core Processors
- Intel® Xeon® Scalable Processors
- Intel® Distribution of OpenVINO™ toolkit
- Intel® Extension for Tensor Flow
- Intel® DevCloud



# Shandong Extreme Vision Smart Traffic Violation Review Solution

## Solution Overview

The Extreme Vision Smart Traffic Violation Review System utilizes Artificial Intelligence to analyze, process, and categorize up to 50,000 traffic images per day. It automatically recognizes violations and incidents and sends related information to an easy-to-use management system. With a flexible design and system that reduces opportunities for human error, the solution helps ensure consistent protocols in a diverse set of use cases.

## Value Props



**Improve detection accuracy** by harnessing AI to intelligently analyze traffic images and implement customized solutions with standardized protocols to reduce judgment inaccuracies and decrease human errors



**Save time** by leveraging the AI-powered computer image algorithm to efficiently analyze, classify, and remove invalid images



**Reduce labor costs** by decreasing the amount of hired personnel needed to perform 24/7 monitoring and analysis of traffic images and effectively execute the appropriate responses

## Intel Components

- Intel® Xeon® Processors
- Intel® Distribution of OpenVINO™ Toolkit

**Target Vertical:**  
Transportation

**Secondary Verticals:**  
Government,  
Manufacturing

**Target Use Case:**  
Situational Monitoring

**Geo Availability**  
People's Republic of China

**Learn More**  
[Shandong Extreme Vision Website](#)

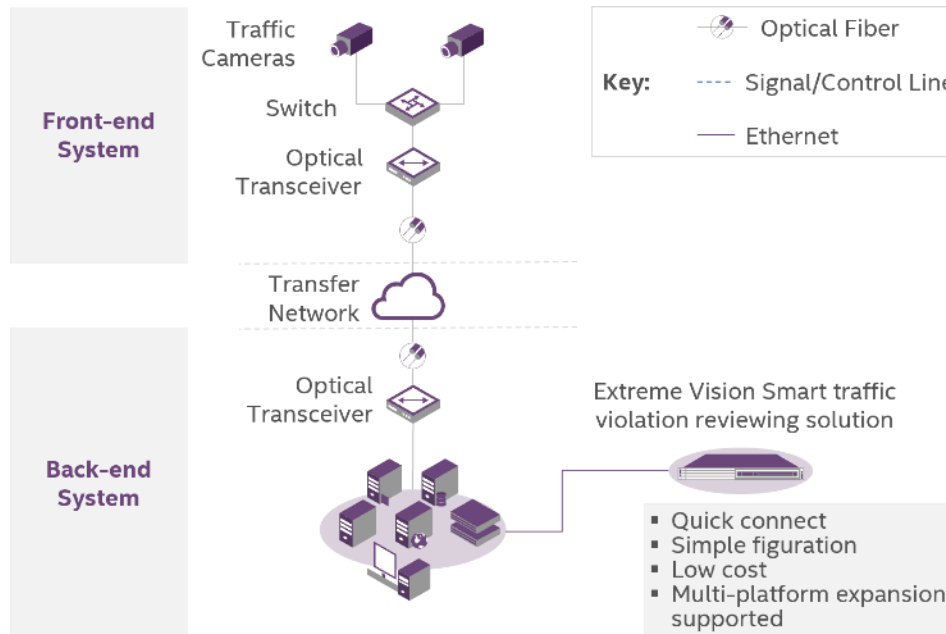





# ShareTech Information OT Security Solution

Back to Manufacturing Solutions

Back to Asset & Operations Optimization Use Cases



## Solution Overview

The ShareTech OT Security Solution protects the network security of the OT environment. To prevent and intercept a network vulnerability from being exploited, the OT security solution uses virtual patches and implements code reviews regularly. Additionally, this solution includes advanced settings to avoid invasion.

## Value Props



Help secure the OT environment with multiple layers of defense including OPC intrusion prevention, industrial protocol support, and big data analytics



Deploy and manage with ease using quick installation settings, instant alarm notifications, and USB instant recovery



Enhance visibility by leveraging big data analysis, big data learning, and virtual patch to surface vulnerabilities

## Intel Components

- Intel® Celeron® Processors
- Intel® i211 Ethernet Controller
- Intel® HD Graphics 500

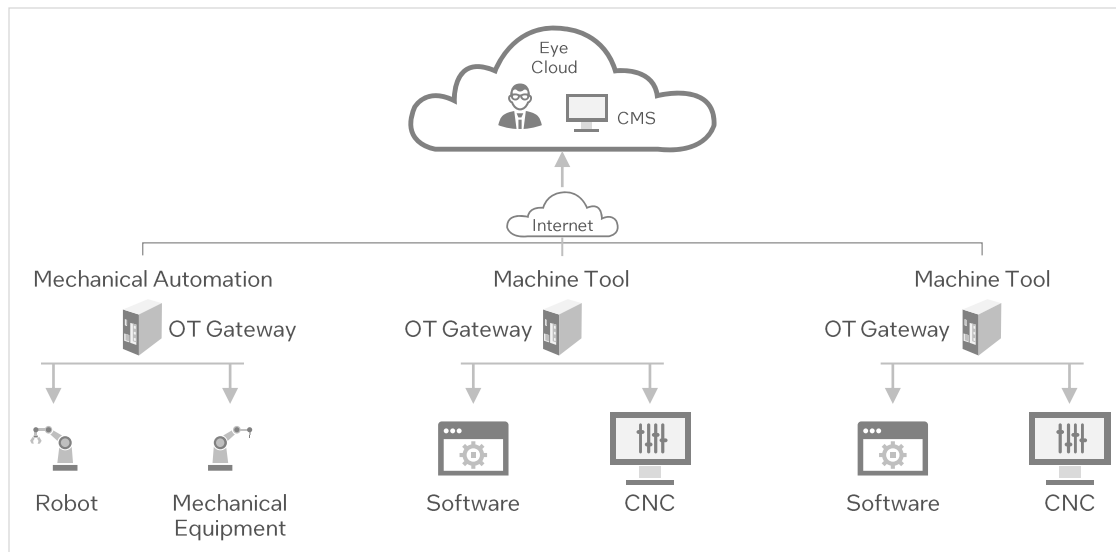

Target Vertical: Manufacturing

Secondary Vertical: Health & Life Sciences

Target Use Case: Asset & Operations Optimization

Geo Availability  
Available in Taiwan

## Learn More

- ShareTech home page
- OT Series ([sharetech.com.tw](http://sharetech.com.tw))



# Shenzhen Extreme Vision Intelligent Security Check

## Solution Overview

The Extreme Vision Intelligent Security Check Solution improves the safety of airports, transit centers, government buildings and other public spaces that require security inspection by identifying potentially dangerous contraband.

**Target Vertical:**  
Transportation

## Value Props



Improve accuracy of security inspections



Deploy quickly and effectively with a solution that can be deployed within just one hour



Reduce security line wait-times with a fast analysis speed

## Intel Components

- Intel® Distribution of OpenVINO™ Toolkit
- Intel® Solid State Drives
- Intel® Core™ i3 processor

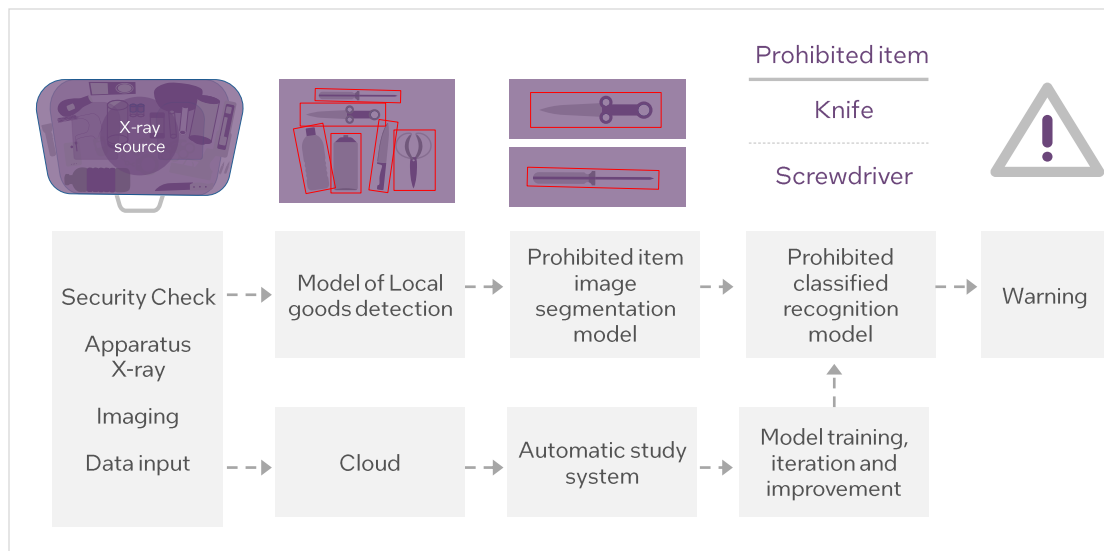

**Target Use Case:**  
Situational Monitoring  
**Secondary Use Case:**  
Product Inspection

**Geo Availability**  
Available worldwide

## Learn More

- The [Extreme Vision Website](#)



# Shenzhen Genew Intelligent Technology Multifunctional Smart LightPoles

## Solution Overview

The future of the light pole is not only in lighting, but also in providing a communication and computing hub for smart cities. With the development of smart poles, Genew Intelligent aims to build a perception layer at the city level and enhance data gathering on traffic, climate, pollution, public facilities status and more. Through data filtering, data analysis, and data fusion, smart poles will assist governments in city-level decision-making provide commercial services to enterprise and public services to citizens. Smart poles can also function as distributed computing edge nodes, allowing many low latency applications to be widely deployable through network connections, on kiosks or through multi-media displays.

## Value Props



**Enables decision making and information visualizations** with advanced analytics on climate, traffic, pollution, public infrastructure monitoring and more



**Enhances network and edge capabilities** for entire cities with proliferation of 5G cells, Wi-Fi hotspots, and edge computing nodes



**Automates and optimizes smart city operations** with integrated modules and algorithms for smart lighting, traffic signal regulation, LED advertising, and facilities status monitoring

## Solution Diagram

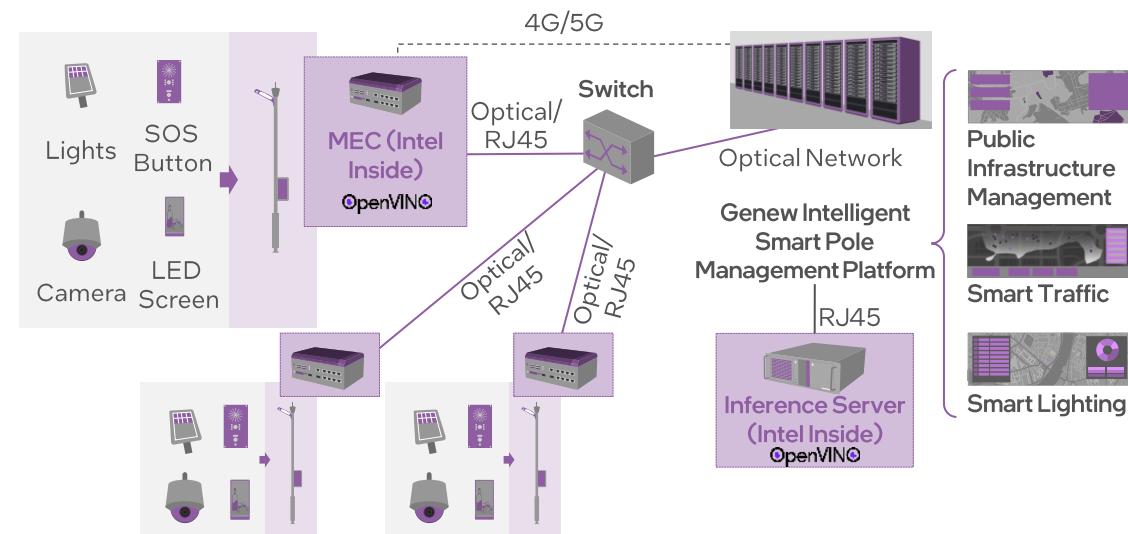

## Intel Components

- Intel® Core™ i3 processors
- Intel® Core™ i5 processors
- Intel® Core™ i7 processors
- Intel® Distribution of OpenVINO™ Toolkit

**Target Vertical:**  
Government

**Secondary Vertical:**  
Energy

**Target Use Case:**  
Environmental Monitoring

**Geo Availability**  
Europe, Middle East, Africa,  
People's Republic of China

**Learn More**

- [首页 | Genew Intelligent \(gnaiot.com\)](#)

## Shenzhen JHCTECH Road Pricing Inspection System

[Back to Transportation Solutions](#)

[Back to Logistics & Tracking Use Cases](#)



### Solution Overview

The JHCTECH Road Pricing Inspection System assesses and manages tolls for passing vehicles and detects vehicle violations. Detectable violations can include illegal modification, missing or obstructed vehicle registration, and oversized or overweight vehicles. The system then automatically flags offending vehicles and charges any corresponding fees or penalties.

### Value Props



Maintain traffic flow and efficiency by eliminating stops for manual inspection



Quickly and accurately assess and distribute fees, minimizing processing time and expense



Create safer roads with immediate response to offending vehicles and driver actions

### Intel Components

- Intel® Distribution of OpenVINO™ toolkit
- Intel® Core™ Processors
- Intel Atom® Processors
- Intel® Movidius® MA2485 VPU

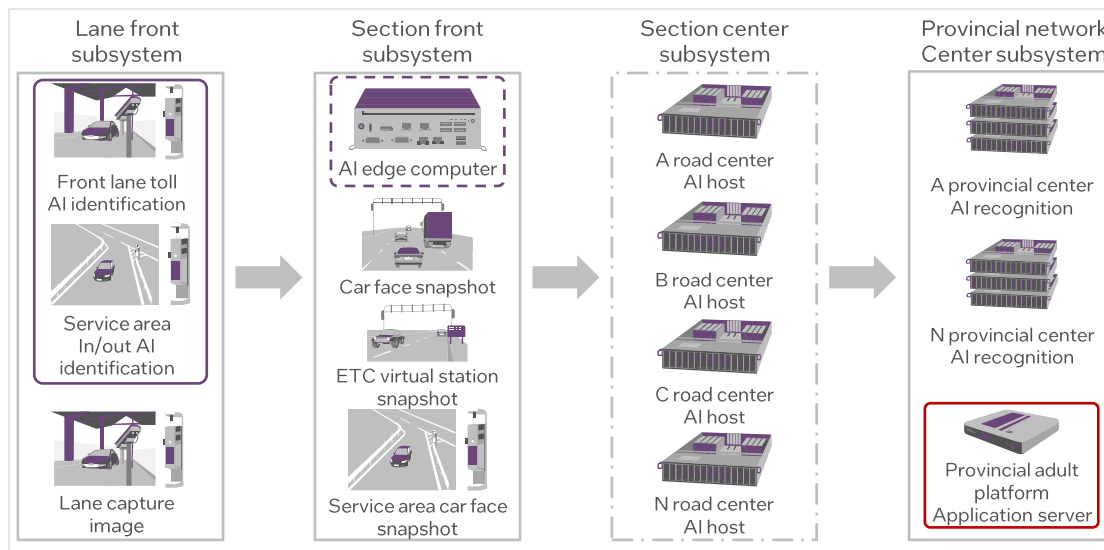

**Target Vertical:**  
Transportation

**Target Use Case:** Logistics & Tracking

### Geo Availability

- Hardware and software are available internationally
- JHCTECH-provided support is available within PRC

### Learn More

- [JHC Technology Homepage](#)

# Shenzhen SED Initta Intelligent POS Solution

## Solution Overview

Through its modular design, the Intelligent POS is deployed with 10.1 or 15.6 inch displays and customized to fit a wide range of floor plans and business needs. Depending on the integration, other hardware such as the integrated facial-recognition scanner, card reader, other frictionless payment scanners, and receipt printers may also be installed. All hardware is then linked to SED's specialized software. All data is captured at the edge during the user-interface and facial recognition data is provided a safe means of transmission for user protection. This data is then ported to on-premise or off-premise cloud storage where it is further secured and analyzed by the Shenzhen SED software, and can be used to help businesses manage promotions, distribute advertising, alert associates for customer assistance, and provide a wide range of helpful analytics.

## Value Props

- Deliver excellent customer experiences** through a modular combination of hardware capable of improving customer experience by meeting a wide range of customer needs
- Streamline in-store operations** through hardware and software solutions that connect customers with assistance and helps employees prioritize time
- Minimize the costs of retail business digital transformation** by reducing expenses through a system designed for seamless integration, scalability, and durability

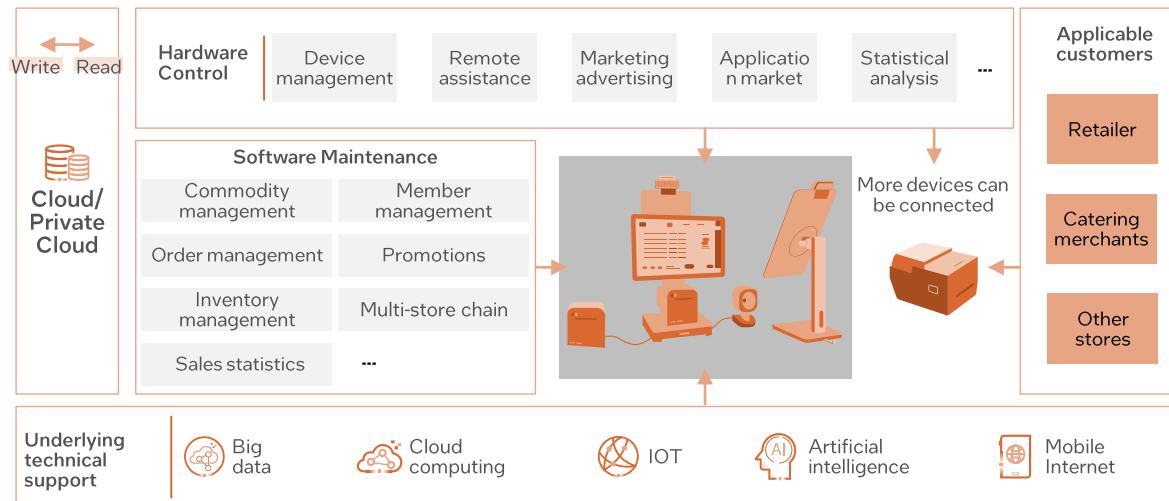

## Kit Components

- Intel® Core™ processors
- Intel® Atom™ processors
- Intel® Celeron® processors
- Intel® Distribution of OpenVINO™ toolkit

**Target Vertical:**  
Retail

**Target Use Case:**  
Interactive Media

**Geo Availability**  
APJ, Americas, Europe, Middle East, Africa, and People's Republic of China

## Learn More

- [Initta Website](#)
- [SED Initta Intelligent POS Video](#)
- [SED Initta Intelligent POS Solution Page](#)

# Shinsegae I&C Spharos Cloud POS

## Solution Overview

Retailers have long struggled with traditional POS systems that lack features and customization, require complex management, have weak data security, and often come with high development, maintenance, and repair costs. The Spharos Cloud POS from Shinsegae I&C addresses these challenges and streamlines retail operations by providing a highly customizable solution that seamlessly integrates POS systems with a wide range of devices and services like mobile order apps, kitchen display systems (KDS), direct information display (DID), kiosks, and vending machines. This innovative solution allows users to personalize their POS by selecting functions from a wide range of value-adding cloud services and empowers businesses with real-time customer data collection, sales monitoring, and CRM integration which power advanced reporting and analytics. Further, the Spharos Cloud POS leverages this data to provide actionable insights that help businesses optimize business operations, enhance service, and provide an unparalleled customer experience.

## Value Props

**Improve user experiences with a personalized POS system** that allows retailers to hand-select features they wish to use and disable features they don't to streamline POS operations and improve functionality.

**Economically operate a wide-range of equipment** by integrating POS, self-checkout, and kiosk, functions into tablets and mobile devices that support the deployment of new payment methods without additional development.

**Gain valuable insights with CRM integration** that collects data to provide information about customer behavior, preferences, and purchasing patterns to enable informed business decisions.

## Intel Components

- Intel® Core™ i3, i5, i7 processors
- Intel® Ethernet Controllers
- Intel® Distribution of OpenVINO™ toolkit
- Intel® Media SDK

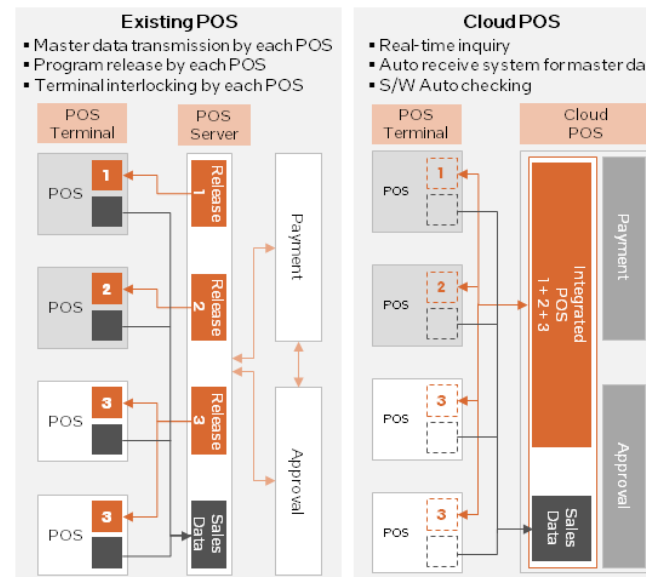

**Target Vertical:**  
Retail

**Secondary Vertical:**  
Hospitality and Restaurants

**Partner Designated Verticals:**  
Food and Beverage,  
Franchising, Unmanned  
Stores

**Target Use Case:**  
Situational Monitoring

**Geo Availability**  
Asia, Pacific, Europe, Middle  
East, and North America

- Learn More**
- Explore Cloud POS solutions
  - Contact us
  - Learn more about SHINSEGAE I&C
  - Visit the Spharos homepage



# Sindrax Intelligent Gamified Kids (Pre-school) Education System

## Solution Overview

An array of digital interactive gamified education products for 2-6 year old kids. These solutions help transform traditional spaces into interactive learning opportunities.

## Value Props

- Promote interactive learning by introducing children to immersive educational tools
- Track behavioral data to enable adaptive learning
- Create technological familiarity with digital activities and games that catered towards young minds

## Intel Components

- Intel® Core™ i3 processors
- Intel® Pentium® processors

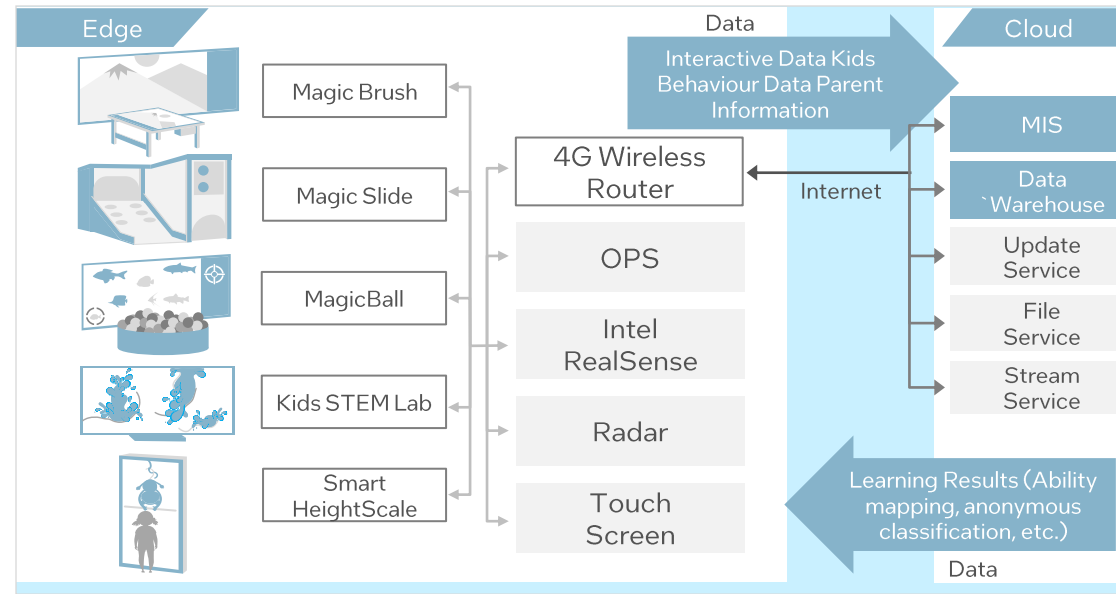

Target Vertical: Education

Secondary Verticals: Retail, Hospitality, Government

Target Use Case: Interactive Media

Geo Availability  
PRC, Southeast Asia, Russia, North America, and Middle East

Learn More

- [Sindrax Website](#)



# Sindrax Technology Interactive Multimedia Sports Game

## Solution Overview

The Interactive Multimedia Sports Game Solution combines cutting-edge technologies such as motion sensor technology and interactive projection systems with traditional sports games to provide interactive recreation and community fun at play areas like trampoline parks and gyms.

## Value Props



Enhance multimedia performance with cutting-edge visual and kinetic technologies through an interactive projection system



Increase player engagement through a gamified platform that digitizes traditional sports to inspire interest in physical activity



Lower operational costs with a simple, single-time hardware installment and centralized content management system to support content upgrades with ease

## Intel Components

- Intel® Distribution of OpenVINO™ toolkit
- Intel® Core™ i3 processors

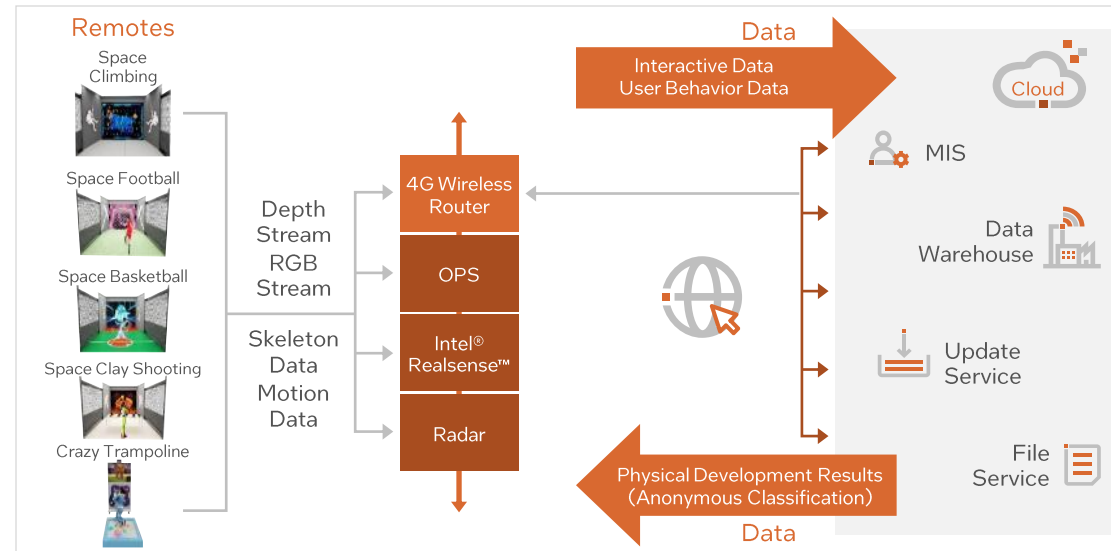

- Intel® Core™ i5 processors
- Intel® RealSense™ Vision Processor

**Target Vertical:** Retail  
**Secondary Verticals:** Education, Hospitality, Gaming & Entertainment

**Target Use Case:** Interactive Media  
**Secondary Use Cases:** Situational Monitoring

**Geo Availability**  
Globally

## Learn More

- [Sindrax Technology Solution Webpage](#)
- [Intel MRS Solution Documentation](#)
- [Solution Exhibition Information](#)



# Skratch & ANQ Phygital Video Wall

## Solution Overview

A customizable, immersive, and interactive advertising solution that creates engaging retail experiences that are able to collect data while enhancing the experience with dynamic display solutions to customize the experiences, blending the physical and digital worlds.

Target Vertical: Retail

## Value Props

- Tailor customer experiences with real-time actionable insights
- Reduce Operational overhead by creating an "endless aisle"
- Create captivating displays by blending physical and digital capabilities to entice and engage all customers

Target Use Case: Interactive Media

## Intel Components

- Intel® Core™ i5 NUC
- Intel® Core™ i7 770k

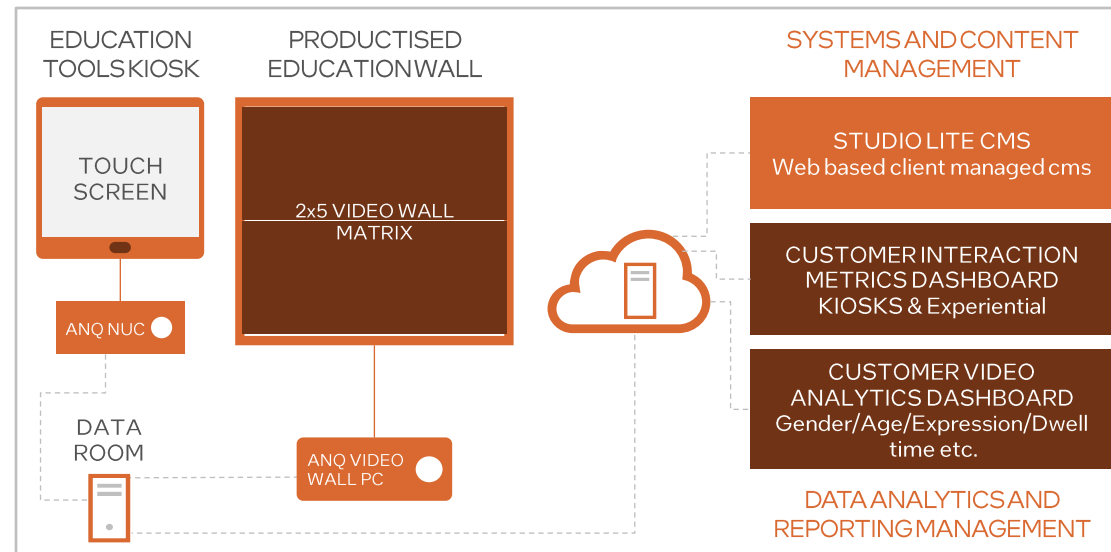

## Geo Availability

Available in Americas, APAC, Australia/New Zealand & EMEA

## Learn More

- [Skratch AV Homepage](#)

# Smart Board Interactive Display with Smart Ops PC

## Solution Overview

SMART Board Interactive Displays with SMART OPS PC provide a comprehensive and simple solution for remote collaboration and distance learning. SMART Board Interactive displays, remote device management, and SMART accessories help people stay connected, businesses maintain productivity, and schools enhance learning.

## Value Props

- Transform your business by creating flexible, dynamic workplaces that empower people to collaborate
- Support remote operations for seamless user experiences
- Reduce implementation time with an intuitive interface that encourages quick adoption

## Intel Components

- Intel® Core™ i3 Processors
- Intel® Core™ i5 Processors

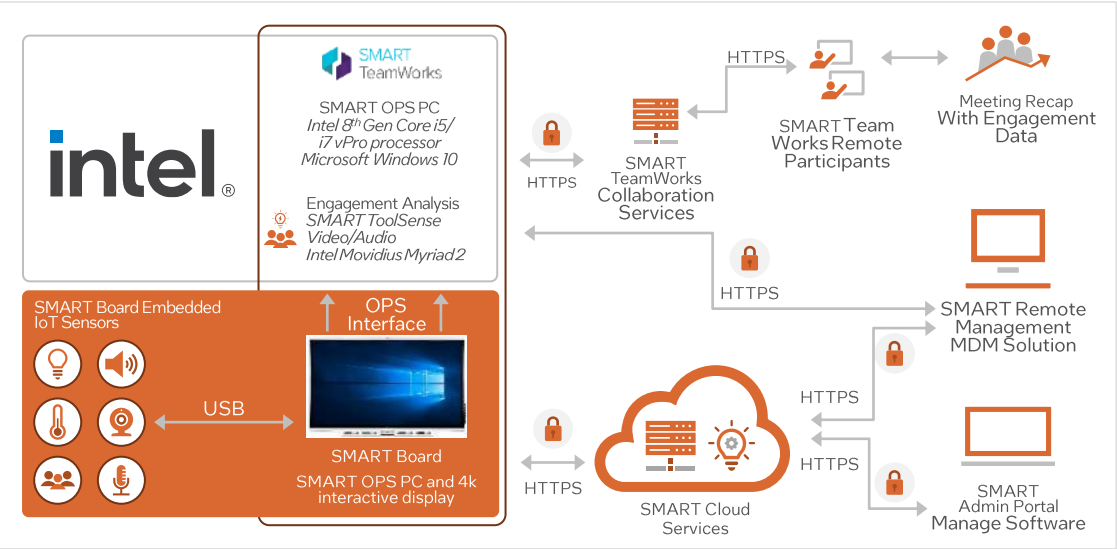

**Target Vertical:** Retail  
**Secondary Verticals:** Education; Government

**Target Use Case:** Interactive Media

**Geo Availability**  
 North America, LATAM, EMEA, APAC

- Learn More**
- [New 7000R SMART Board Video](#)
  - [SMART Teamworks Video](#)
  - [New in SLSO Video](#)



# SMRT1 POD

[Back to Retail Solutions](#)

[Back to Control Optimization & Autonomy Use Cases](#)



## Solution Overview

SMRT1 POD is an interactive, cloud-connected, smart dispensing solution that provides an engaging, frictionless, convenient, customer experience. Businesses are empowered with tailored real-time dashboard analytics to help make informed data-driven decisions.

## Value Props



Grow profits with display screen prompts promoting customers to increase their average order size



Gain actionable insights with customer interaction analytics



Adapt to different scenarios with flexible features such as temperature controlled for food safety, smart lockers for curbside pickup, and more

## Intel Components

- Intel® Core™ i7
- Intel Reference Design for Intelligent Vending

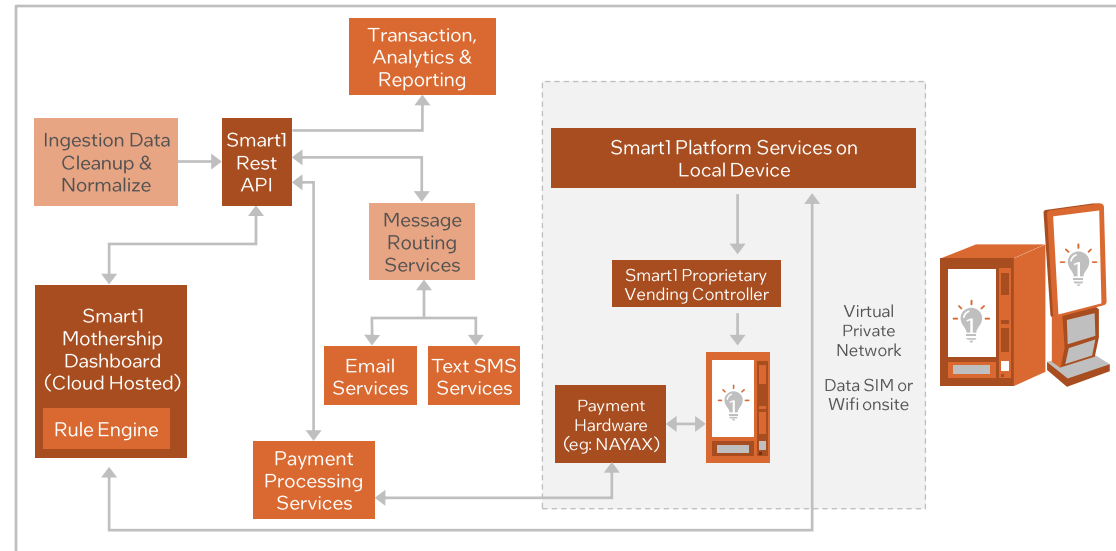

**Target Vertical:** Retail

**Secondary Verticals:** Health & Life Sciences

**Target Use Case:** Control Optimization & Autonomy

**Secondary Use Cases:** Asset & Operations Optimization; Human Wellness Monitoring; Interactive Media; Situational Monitoring

## Geo Availability

Available in Brazil, Canada, Mexico, United States, Other Americas



## Learn More

- [SMRT1 Homepage](#)

## Solution Overview

JOI® Smart Classroom provides a flexible learning approach for school environments. Teachers can stay in touch with their students, control student access to the content, and assess each student through progress monitoring and behavioral analytic features.

## Value Props

-  Increase educational outcomes through holistic education with a program that promotes the higher-level thinking skills
-  Broaden the reach of education with remote teaching features
-  Tailor learning to students with behavioral analytics and other digital learning features

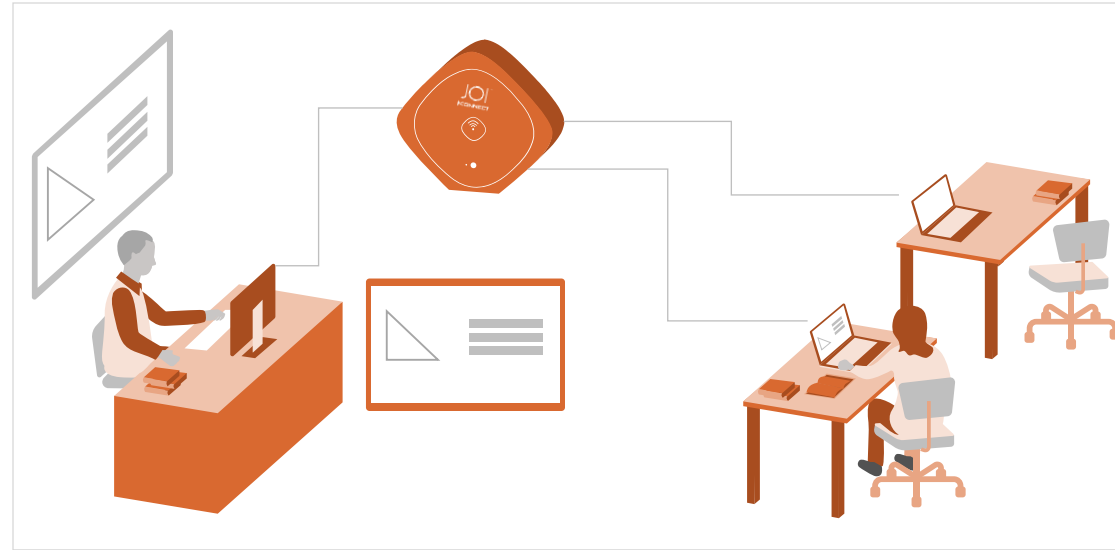

## Intel Components

- Intel® Distribution of OpenVINO™ toolkit
- Intel Atom® Processors
- Intel® Celeron® Processors
- Intel® Core™ i3, i5, and i7 Processors

**Target Vertical:** [Retail](#), [Education](#)

**Target Use Case:** [Asset & Operations Optimization](#)

**Secondary Use Cases:** [Interactive Media](#), [Human Wellness Monitoring](#)

### Geo Availability

Available in South East Asia

### Learn More

- [SNS Network SDN BHD JOI Smart Classroom website](#)
- [JOI Smart Classroom video](#)

# Sophic Automation Sdn Bhd Manufacturing Lights Off

## Solution Overview

Manufacturers are looking for ways to increase operational efficiency while simultaneously decreasing operating costs to improve employee working conditions and manufacturing throughput. Sophic Automation Sdn Bhd Manufacturing Lights Off solution analyzes machine operations data to provide predictive maintenance, remote service, connected logistics, and optimize asset performance management to enable industry 4.0 smart factories.

## Value Props

- Optimize production operations with an easy-to-use performance management system that monitors machine throughput performance
- Reduce machine down-time with predictive maintenance that reduces overall production errors
- Reduce operational costs by connecting multiple production machines to a single operator through remote access and connected logistics

## Intel Components

- Intel® Celeron® Processors
- Intel® Xeon® Silver Processor
- Intel® Core™ i5 Processors
- Intel® Xeon® Processor E5
- Intel® Core™ i7 Processors
- Intel® Distribution of OpenVINO™ toolkit

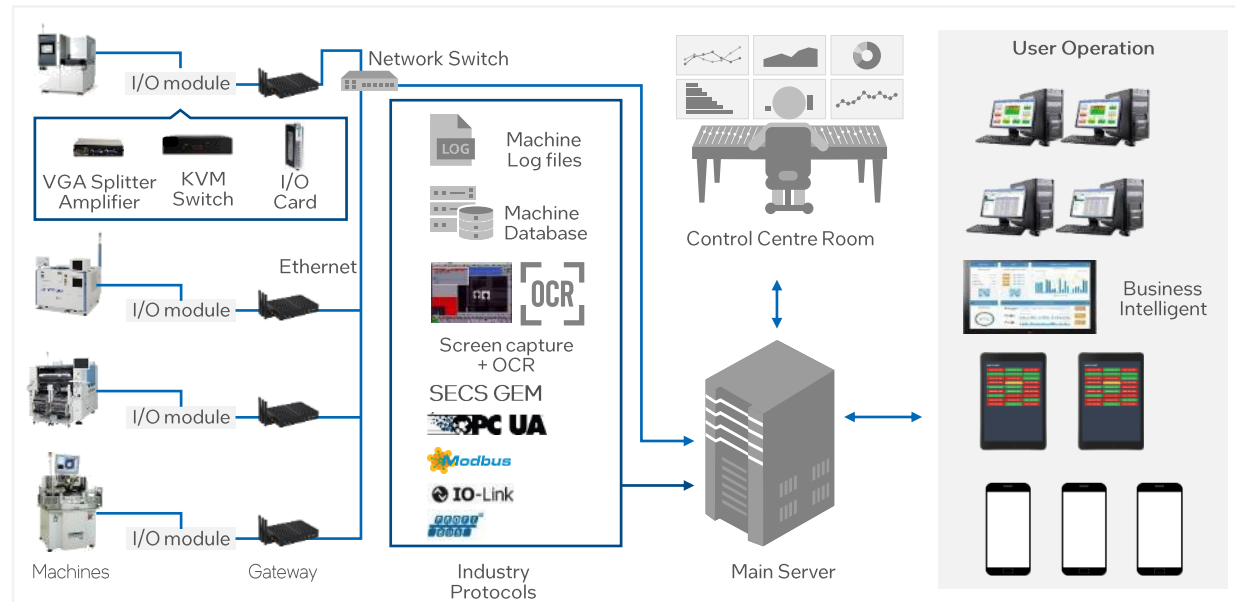

Target Vertical:  
Manufacturing

Target Use Case:  
Machine Condition Monitoring

Geo Availability  
APJ

### Learn More

- [Sophic Automation Home](#)
- [SMARTer Machine Automation](#)



# SSE Mayflower Insite Sentinel

## Solution Overview

SSE's Mayflower Insite Sentinel optical sensor (Sentinel) is an IoT connected device that anonymously counts and classifies objects (e.g. vehicles, bikes and people) to assess traffic flow, vehicle classification, velocity, and pedestrian footfall. Sentinel enables users to act on key information regarding urban activity to better inform policies and strategies.

## Value Props



**Harness near real-time data:** to accomplish instant situational risk assessment, incident management, and first responder coordination



**Leverage comprehensive data analysis:** to make informed decisions and plans to improve traffic flow, pedestrian safety, and pollution.



**Employ fully customizable dashboards:** to combine sensor and device data with third-party data sets, generate greater insights, and share data with specific teams

## Kit Components

- Intel® Atom® Processors
- Intel® Distribution of OpenVINO™ Toolkit
- Intel® Movidius™ VPUs
- Intel® Ethernet Network Adaptors

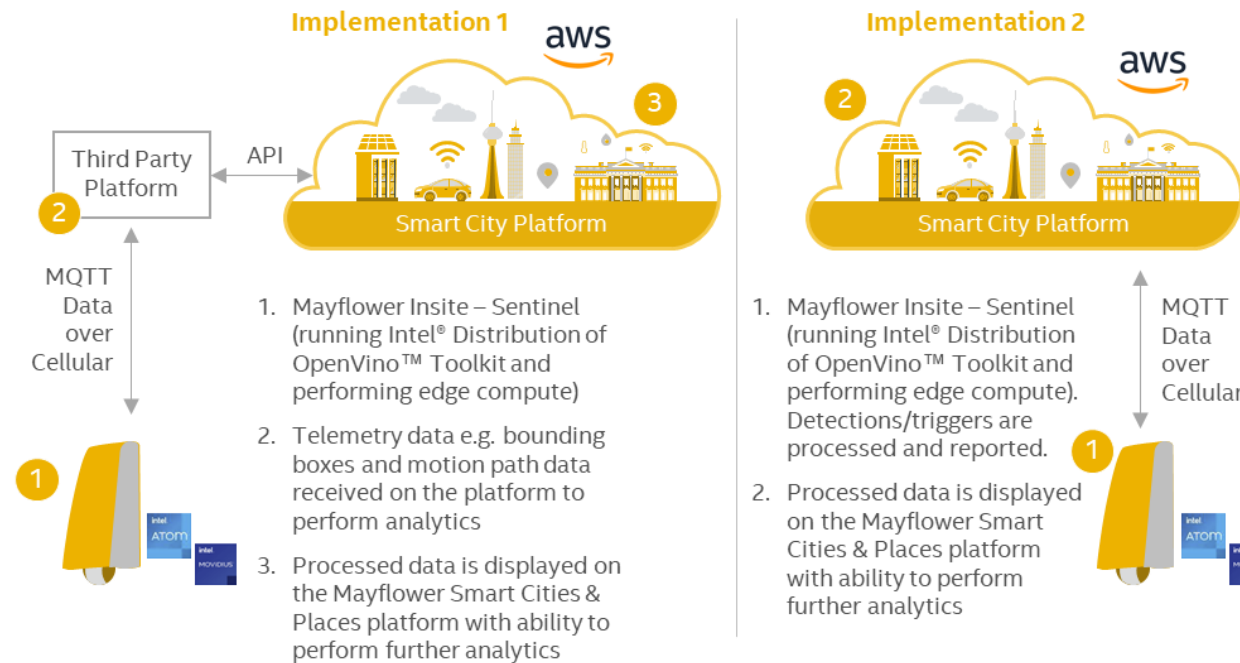

Target Vertical:  
Energy

Secondary Vertical:  
Government; Transportation

Target Use Case:  
Situational Monitoring

Secondary Use Case:  
Other

Geo Availability  
UK, Ireland, and Europe

Learn More

- [Mayflower Solution Webpage](#)



Back to Transportation Solutions

Back to Situational Monitoring Solutions



# 7 StarLake 5G C-V2X Smart Traffic

## Solution Overview

The future of intelligent transportation will focus on developing effective vehicle/pedestrian management, improving road safety, and enhancing the operational performance of transport networks. Metropolis officials want to leverage advanced technologies to connect infrastructures for greater visibility and strong management of city operations. The 7StarLake 5G C-V2X Smart Traffic solution leverages and connects 5G connectivity, AIoT technology, and vehicle sensors to quickly capture data to monitor public safety and provide citizens or public officials with real-time road safety alerts.

## Value Props



Enable AI + IoT connectivity with IoT vehicle sensors utilizing 5G and cutting-edge AI algorithms to identify, predict, and learn traffic patterns



Help increase public safety by monitoring pedestrian and vehicle incidents to expedite emergency responses



Improve road infrastructures by tracking traffic signs, collecting real-time heat map information, and obstacle detection tools to adapt roadway signals

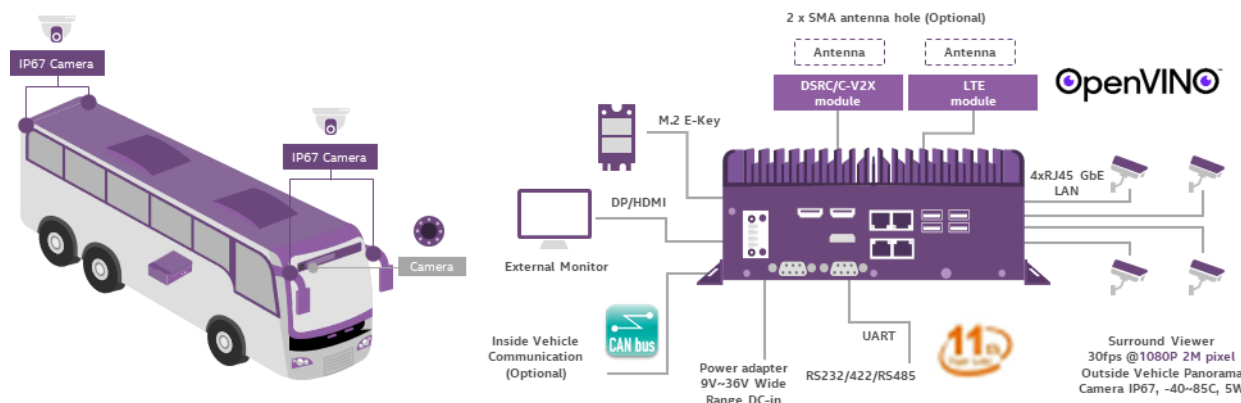

## Intel Components

- Intel® Distribution of OpenVINO™ Toolkit
- Intel® Core™ i7 Processors
- Intel® Xeon SP Silver

Target Vertical: Transportation and Warehousing

Secondary Vertical: Government

Target Use Case: Situational Monitoring

Secondary Use Case: Environment Monitoring

Geo Availability: APJ, Americas, Europe, Middle East, and Africa

## Learn More

- 7 StarLake Website
- AI Infrastructure For Autonomous Driving Video

# Staqu Technologies JARVIS For Manufacturing

## Solution Overview

JARVIS for Manufacturing by Staqu Technologies is an audio and video analytics solution that converts standard existing cameras into smart cameras with intelligent monitoring capabilities of persons, objects, perimeter, and vehicles. With JARVIS, manufacturing facilities can benefit from centralized monitoring of cameras, intelligent insights, automated real-time alerts, and quality inspection monitoring.

## Value Props



Enhance safety and security with a solution that automates detection of unusual activity, employee safety compliance, and alerts staff in near real-time



Increase profits with a quick ROI as the solution helps reduce theft and pilferage costs, and excess security manpower costs



Improve efficiency and productivity by implementing artificial intelligence to ensure staff productivity and efficiency across various business units

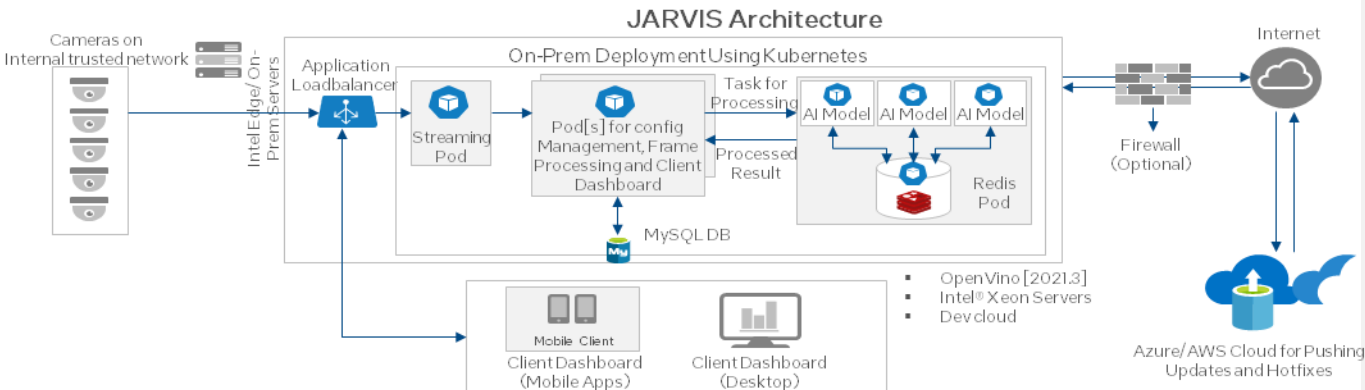

## Intel Components

- Intel® Xeon® SP Silver
- Intel® Xeon® SP Gold
- Intel® Vision Accelerator Design With Intel® Movidius™
- VPU
- Intel® Distribution of OpenVINO™ toolkit
- Intel® Core™ i7 Processors

Target Vertical:  
Manufacturing

Secondary Vertical:  
Government

Target Use Case:  
Situational Monitoring

Geo Availability  
Canada, United States, India, Middle East, North Africa, and Turkey

## Learn More

- [Staqu JARVIS Homepage](#)
- [JARVIS by Staqu Youtube and Video Testimonials](#)





# ST Engineering AGIL Smart Car Park Suite

## Solution Overview

The AGIL Smart Car Park suite unifies all car park operations on a single robust, cloud-based platform to provide convenient and seamless car parking services. The solution enables real-time visibility and valuable analytics on car park operations, such as occupancy status and fee collection, to optimize parking space utilization, improve operational efficiency, and streamline maintenance.

## Value Props



Decrease operational costs by reducing manual labor and replacing ticketing and parking meters with cashless payment



Increase revenue potential with dynamic or premium pricing models and data analytics for effective and targeted enforcement



Leverage actionable insights through data analytics that use drivers' parking behavior to optimize parking lot allocation, enhance city planning, and display targeted advertisements

## Kit Components

- Intel® Core™ i5 Processors
- Intel® Movidius™ VPUs
- Intel® Distribution of OpenVINO™ Toolkit

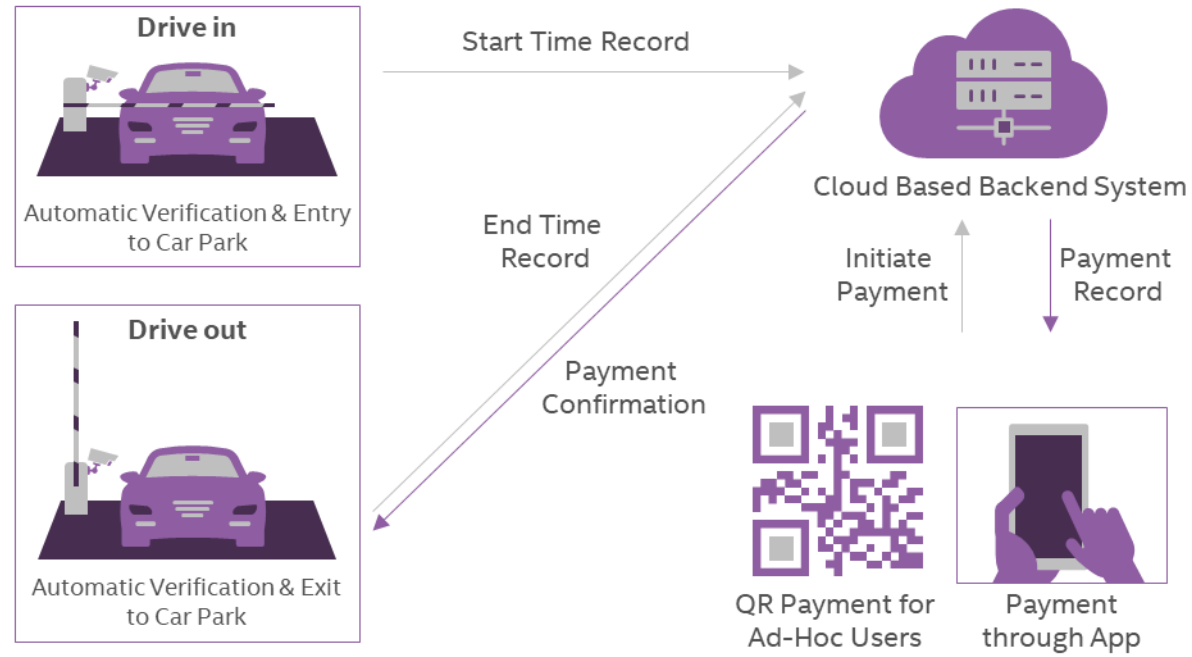

**Target Vertical:**  
[Government](#)

**Secondary Vertical:**  
[Banking/Financial Services](#),  
[Education](#), [Health & Life Sciences](#), [Hospitality](#), [Retail](#),  
[Transportation](#)

**Target Use Case:**  
[Situational Monitoring](#)

**Secondary Use Case:**  
[Asset & Operations Optimization](#),  
[Product Inspection](#)

**Geo Availability**  
Singapore, Myanmar,  
Malaysia, Vietnam,  
Philippines, Middle East

## Learn More

- [ST Engineering Website](#)
- [AGIL Smart Car Park Suite Website](#)



Back to Manufacturing Solutions

Back to Control Optimization and Autonomy Use Cases



# Supermicro Industry 4.0 Evolving

## Solution Overview

Supermicro’s Industry 4.0 Evolving solution with NodeWeaver virtualization and management platform is an end-to-end offering that provides high performance Edge Computing servers – or “thick Edge computing”, Artificial Intelligence (AI), Internet of Things (IoT), data security, and ultra low-latency computing to support digital transformation and Industry 4.0 initiatives, and responses to real-time data intelligence and critical events.

## Value Props



Streamline operations by leveraging real-time data from sensors to optimize overall production, quality and Overall Equipment Efficiency (OEE)



Reduce compute costs with faster image processing on the Edge and model re-training versus the Deep Learning (DL) training routines, which typically demand massive amounts of compute power.



Reduce errors and increase quality by updating process and tools in real-time based on insights from captured data

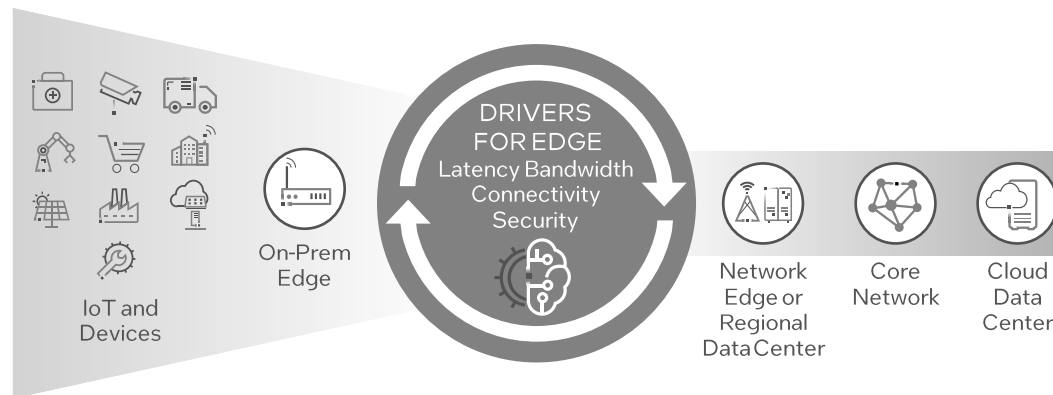

## Intel Components

- Intel® Core™ Processors
- Intel® Distribution of OpenVINO™ Toolkit
- Intel® Xeon® Scalable Processors

## Target Vertical:

Industrial, Manufacturing, Automation

## Secondary Verticals:

Transportation, Retail, Energy

## Target Use Case:

Control Optimization and Autonomy (high availability, redundancy w/ self healing)

## Secondary Use Case:

Machine Condition Monitoring

## Geo Availability

Asia, Pacific, and Japan, Americas, Europe, Middle East, and Africa/Global

## Sales Contact

Jeff Sharpe  
[JeffSharpe@Supermicro.com](mailto:JeffSharpe@Supermicro.com)

## Learn More

- [Supermicro Website](#)



Back to Manufacturing Solutions

Back to Control Optimization and Autonomy Use Cases







# Supermicro Intelligent Secure Edge

## Solution Overview

Combining the power of Supermicro intelligent security with the reliable Intel components and VSBLTY's AI/ML-based insights, the Supermicro RADAR platform equips users with key data insights and automated system management for critical event detection, automatic alarms, mechanical triggers, and more. Supermicro RADAR Secure Edge provides customers with the means to achieve greater transparency, efficiency, and safety in complex environments.

## Value Props

-  Helps manage safety and environmental quality with a system capable that can help optimize traffic flows, air quality, logistics, energy, and more
-  Empower response teams with "Smart Sensing" technology that empowers business with the ability to monitor localized events
-  Promote intelligent decision-making through VSBLTY AI-led actionable insights to help reduce inefficiencies
-  Optimize existing budgets by using intelligent Secure Edge's tools to mitigate redundancies and increase transparency by the ISE's data and insights generator

## Intel Components

- Intel® Xeon® Processors
- Intel® Distribution of OpenVINO™ Toolkit

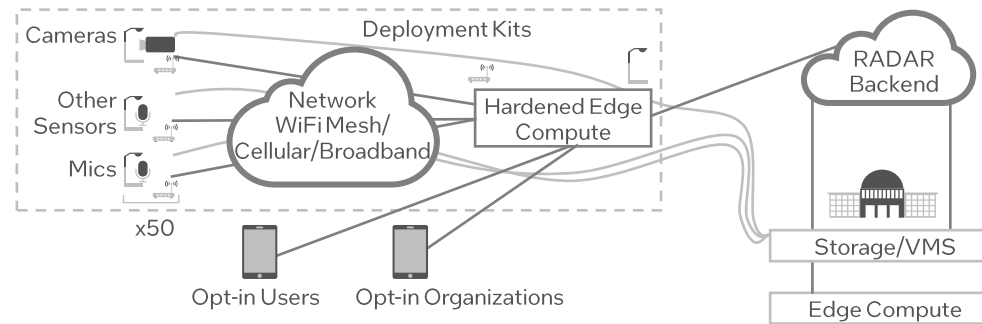

**Target Vertical:**  
Industrial, Manufacturing  
**Secondary Verticals:**  
Agriculture, Energy,  
Hospitality, Retail,  
Transportation

**Target Use Case:**  
Control Optimization and  
Autonomy  
**Secondary Use Case:**  
Human Wellness  
Monitoring, Situational  
Monitoring

**Geo Availability**  
Asia, Pacific, and Japan,  
Americas, Europe, Middle  
East, and Africa

**Sales Contact**  
Jeff Sharpe  
[JeffSharpe@Supermicro.com](mailto:JeffSharpe@Supermicro.com)

- Learn More**
- [Supermicro IoT Edge-Extending Intelligence to Connected Devices](#)
  - [About Us | Supermicro](#)



Back to Retail Solutions

Back to Control Optimization & Autonomy Use Cases



# Super Micro Computer Inc. Retail Edge Evolution

## Solution Overview

The Super Micro Computer Inc. and Acumera Reliant Edge Platform provides a pre-configured, hardened Edge compute platform that utilizes leading tools for virtualization, containerization, centralized management, and comprehensive monitoring. Supported by Super Micro Computer Inc.'s Edge Servers to converge new and old legacy systems on to a scalable integrated system, collected data can then be transmitted to a cloud-based web UI and REST-fel API enabled Platform Manager that can either be cloud agnostic, or hosted through 3<sup>rd</sup> party providers like AWS, Google Cloud, or Microsoft Azure. From here, customer admin can manage major or micro configurations across one, a set, or all sites, applications, and target endpoints. This solution significantly simplifies the deployment, management, orchestration, and networking of Edge infrastructure and applications to help small-to large retail and hospitality businesses create unique and valuable customer experiences and optimize inventory and operations.

## Value Props



**Reduce environmental impact** by leveraging the solution's energy-efficient computing technology that reduces power consumption of server, blade, workstation, and storage systems



**Simplify operations** by centralizing management of deployed infrastructure and applications



**Increase profits** by reducing your overall IT investments and operating expenses with a pre-built and fully customizable, hardware agnostic software platform

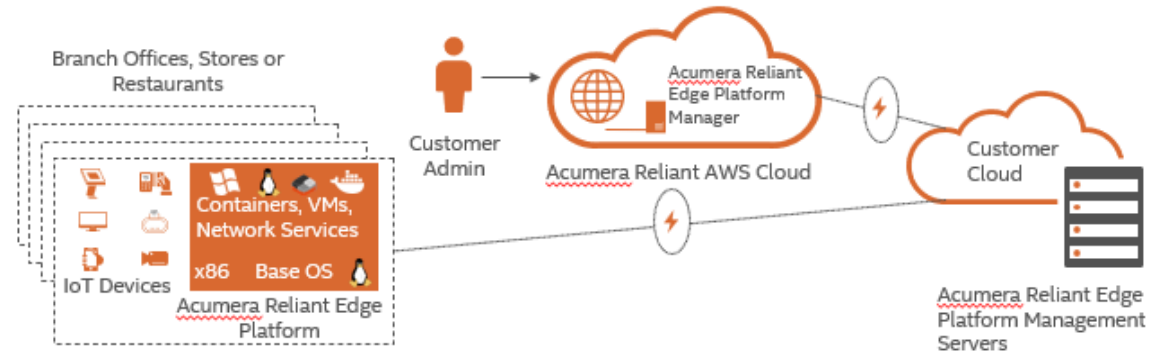

## Intel Components

- Intel® Xeon® D Processors
- Intel® Atom® C3000 Processors

**Target Vertical:**  
Retail

**Secondary Vertical:**  
Hospitality

**Target Use Case:**  
Control Optimization & Autonomy

**Geo Availability**  
APJ, Americas, Europe, Middle East, and Africa

## Learn More

- [Supermicro IoT Edge Homepage](#)
- [Solution Brief - Acumera Reliant Edge](#)



Back to Manufacturing Solutions

Back to Asset & Operations Optimization Use Cases



# Supermicro Smart Digitalized Production Process Enhances Quality Control

## Solution Overview

Supermicro SYS-E100-9W-IA and SYS-1019P-FHN2T integrated with Beijer iX software provides a powerful data acquisition and visualization edge computing solution by enabling factories to collect and exchange data from a PLC or controller and connect to production manufacturing systems like MES, ERP, and other critical operations to help optimize workflows, automate systems, and execute on insights.

## Value Props



Helps lower TCO of IoT at the edge by providing an architecture that consolidates data across multiple workloads through a single platform



Optimizes and automates operations and data management through robust self-learning tools to refine deep learning, automations, and more



Empowers stakeholders with actionable insights that help reduce redundant tasks and helps customers streamline results

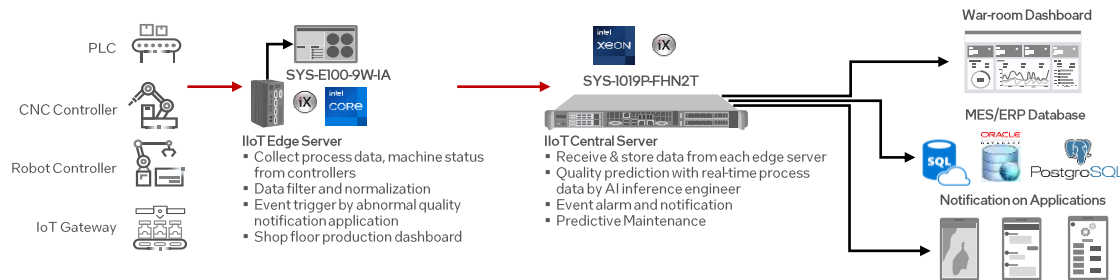

## Intel Components

- Intel® Xeon® SP Silver processors
- Intel® Core™ i7 processors
- Intel® Ethernet Controllers
- Intel® Optane SSD

Target Vertical: Manufacturing

Target Use Case: Asset & Operations Optimization

Secondary Use Case: Control Optimization and Autonomy

Geo Availability  
Asia, Pacific, and Japan, Americas, Europe, Middle East, and Africa, People's Republic of China

## Learn More

- [Supermicro Solutions for Industry 4.0 – Video](#)
- [T-Systems Edge Platform Delivers Low Latency with Supermicro – Video](#)



# Systems with Intelligence Visual/Thermal Asset Monitoring System

## Solution Overview

A monitoring system that provides real-time visualization of industrial applications in harsh, remote locations and is designed to protect and prolong the life of high value assets.

## Value Props



Increase safety with remote inspections ensuring physical security elements are in good condition



Prevent outages with condition-based maintenance



Lower cost with reduced truck rolls and man hours for various inspections and procedures

## Intel Components

- Intel Atom® Processor E3845
- Intel® I3 Dual Core™ Processor

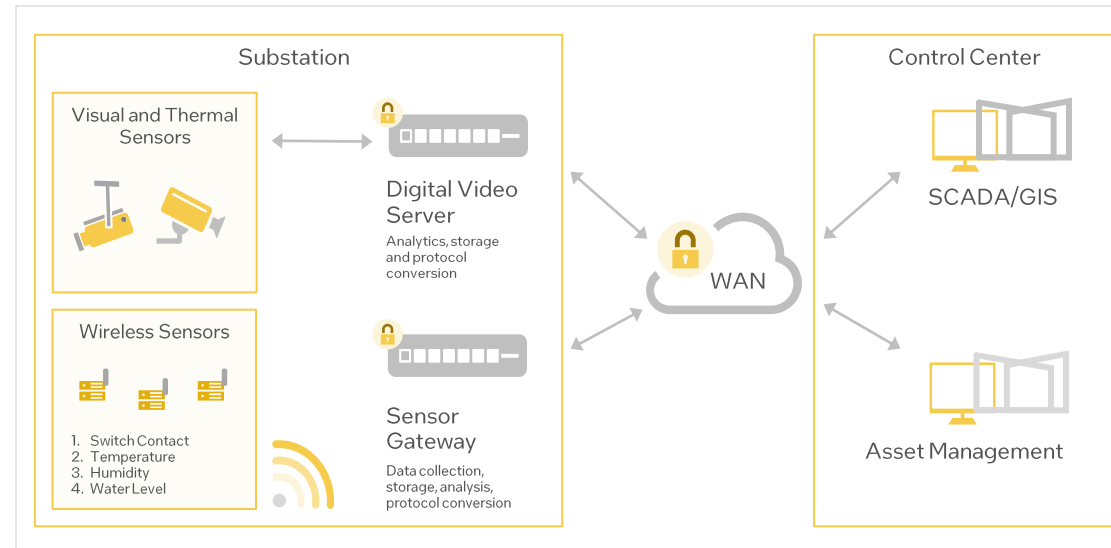

**Target Vertical:** Energy  
**Secondary Verticals:** Manufacturing

**Target Use Case:** Situational Monitoring  
**Secondary Use Cases:** Machine Condition Monitoring, Asset & Operations Optimization, Energy Monitoring & Management

**Geo Availability:** Americas, EMEA, and APAC

### Learn More

- Systems With Intelligence [website](#)
- Real-Time Remote Monitoring of Sites and Assets [article](#)



# Synnex Technology International - Smart MES for Factory

## Solution Overview

In modern factories, production processes have become increasingly complex, involving a variety of work and information flows that require integration. Smart MES for Factory is a solution designed to not only monitor all the simultaneous processes of a factory floor, but to coordinate and control various operations in the manufacturing process with AI and edge computing. It identifies issues with production and compares end results with planned and designed production activities. The solution leverages this information to generate operating instructions, enabling manufacturing enterprises to monitor production in real-time, enhance production efficiency and quality, and reduce overall costs.

## Value Props



**Monitor production in real-time** with an aggregated visualization platform which provides a view into all operations and sends alerts to relevant stakeholders when problems arise

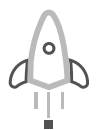

**Improve production efficiency** by identifying problems such as bottlenecks, downtime, or errors in final products, and then by using the solution to generate potential fixes and boost productivity



**Streamline workflow management** with assembly line capabilities that track production progress, improve product tracking and accountability, and generate comprehensive production records.

**Realtime GigaFog IoT**  
Real-time smart manufacturing computing center

- Features:**
- Ensure the stability of collecting and monitoring machine data.
  - Provide storage for long-term, large-scale data.
  - Meet the requirements for conducting big data analysis.

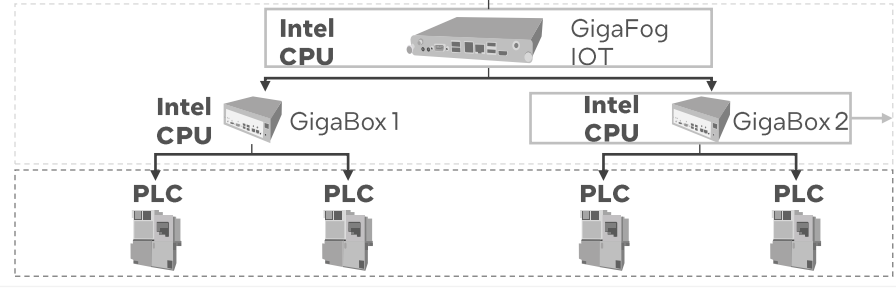

**GigaBox IoT**  
Real-time cross-device data processing platform

**Features:**

- Support LAN/WIFI.
- At most 10 machines collection at the same time.
- Ensure data non-loss.
- Providing flexible platform to develop.

## Intel Components

- Intel® Xeon® E5 processors
- Intel® Core™ i5 processors
- Intel® Celeron® J processors

**Target Vertical:**  
[Manufacturing](#)

**Secondary Vertical:**  
[Energy](#)

**Target Use Case:** [Machine Condition Monitoring](#)

**Secondary Use Case:** [Situational Monitoring](#)

**Geo Availability**  
APJ, PRC

**Sales Contact:** Elsa Tsai - [elsatsai@synnex.com.tw](mailto:elsatsai@synnex.com.tw)

**Solution Webpage**  
[MES real-time operation management platform: cetech](#)

**Learn More**

[Synnex Group \(synnex-grp.com\)](http://Synnex Group (synnex-grp.com))



# Tata Consultancy Services Ltd. TCS Equiptix

## Solution Overview

Based on the TCUP-TCS Connected Universe Platform, the Tata Consultancy Services TCS Equiptix helps manufacturers monetize data from connected products through predictive maintenance of the OEM's installed base and enables proactive mitigation of potential contract risks.

## Value Props

- Improve equipment reliability** with ready-to-deploy TCS ML models for health score computation to increase availability of the installed base
- Reduce cost to serve** with advanced predictive maintenance for better service order planning
- Raise contract profitability** with ML models to identify the best price for new contracts and manage risk of existing ones

## Intel Components

- Intel® Atom® Processors
- Intel® Xeon® Processors

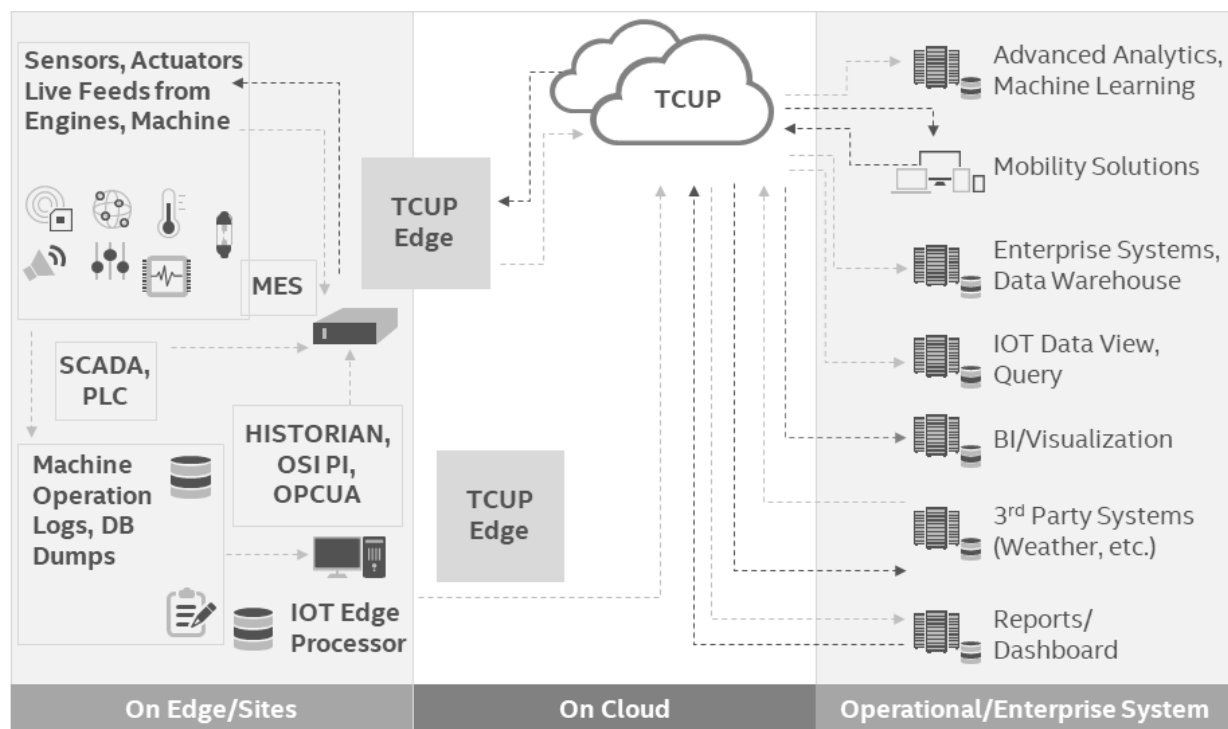

**Target Vertical:**  
Manufacturing

**Secondary Verticals:**  
Energy; Government; Health & Life Sciences; Hospitality

**Target Use Case:**  
Machine Condition Monitoring; Predictive Maintenance; Profitability Simulation

**Secondary Use Case:**  
Asset & Operations Optimization; Energy Monitoring & Management; Environment Monitoring

**Geo Availability**  
Globally Available

## Learn More

- [TCS Equiptix Webpage](#)
- [TCS Equiptix Video](#)





# Tata Consultancy Services Ltd. Self-Checkout Loss Prevention Solution

## Solution Overview

Retailers employ self-checkout (SCO) machines to enhance the stores operations and minimize queues for customers by eliminating staff-operated checkout processes. However, autonomous SCO machines also increase the possibility of theft and fraud. For every instance of theft or fraudulent activity, stores must sell roughly one hundred of the same product to recover the loss. Tata Consultancy Services Self-Checkout Loss Prevention Solution utilizes AI in SCO machines to automate and streamline theft and fraud detection by alerting store managers, who can halt transactions with a touch of a button. The TCS solution can empower retailers with the tool they need to help reduce theft and retail shrinkage.

## Value Props



Help reduce retail shrinkage with real-time theft and fraud alerts to a store manager that can halt said transaction before the culprit can leave the premises with stolen goods



Reduce operational costs by automating product security with SCO machines



Increase return on investment on security infrastructure by employing an effective loss prevention system that integrates seamlessly with existing CCTV systems

## Intel Components

- Intel® NUC
- Intel® Core™ i7 Processors
- Intel® Xeon® Processors
- Intel® Distribution of OpenVINO™ toolkit

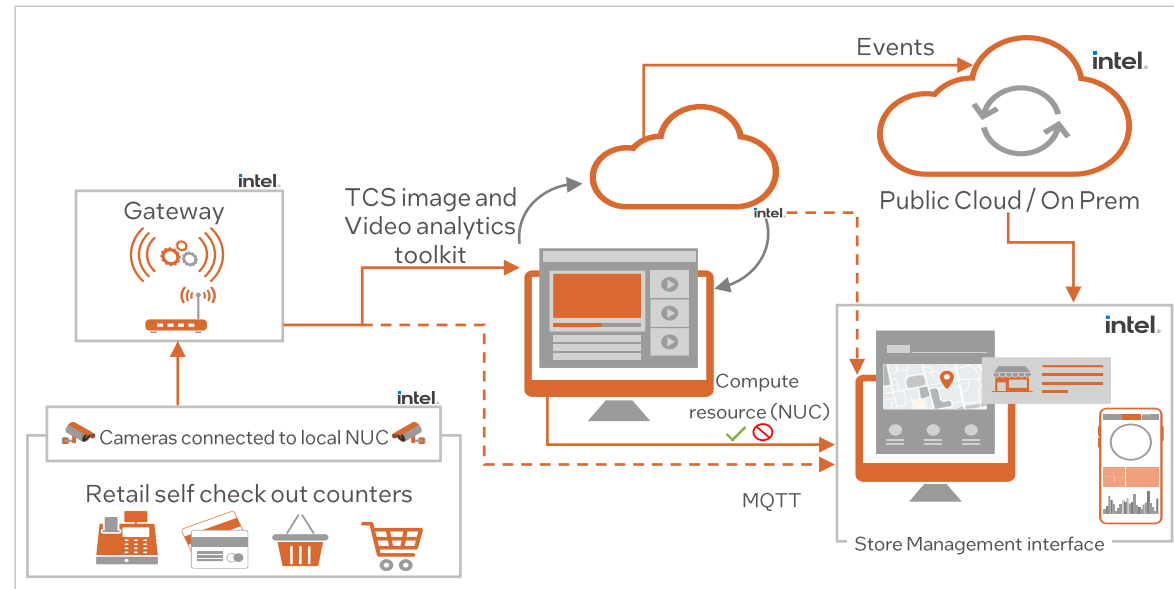

Target Vertical:  
Retail

Target Use Case:  
Asset & Operations  
Optimization

Geo Availability  
Asia-Pacific and Japan,  
Americas, Europe, Middle  
East, and Africa

## Learn More

- [TCS Home Website](#)
- [TCS Worldwide](#)



# Mobile Connected First Responder

## Solution Overview

First responders use various mobile devices such as vehicle and body cameras, rugged computers, and recording devices to capture and send data instantly to an edge server. This real-time processing enables quick responses to urgent situations. After processing, the data is sent securely to the cloud via a mobile router, making it globally accessible to authorized personnel. This combination of edge technology and cloud connectivity allows first responders to make immediate decisions and ensures broad availability of data for coordinated efforts across agencies. Available complementary solutions include mobile data terminals, records management systems, computer-aided dispatch, GPS, automatic vehicle location, 3D scanning, and Mission Critical Push To Talk.

## Value Props



**Empower informed decisions and swift action** by leveraging edge connectivity & compute to provide first responders with access to critical information in real time.



**Facilitate a unified response system** by implementing an integrated approach that drives seamless coordination between agencies and ensures all responding teams are in sync.



**Enhance operational efficiency** with a comprehensive technology solution that equips first responders with the technology they require to efficiently, effectively, and safely serve their communities.

## Intel Components

- Intel® Core™ i5 Processors
- Intel® Core™ i7 Processors

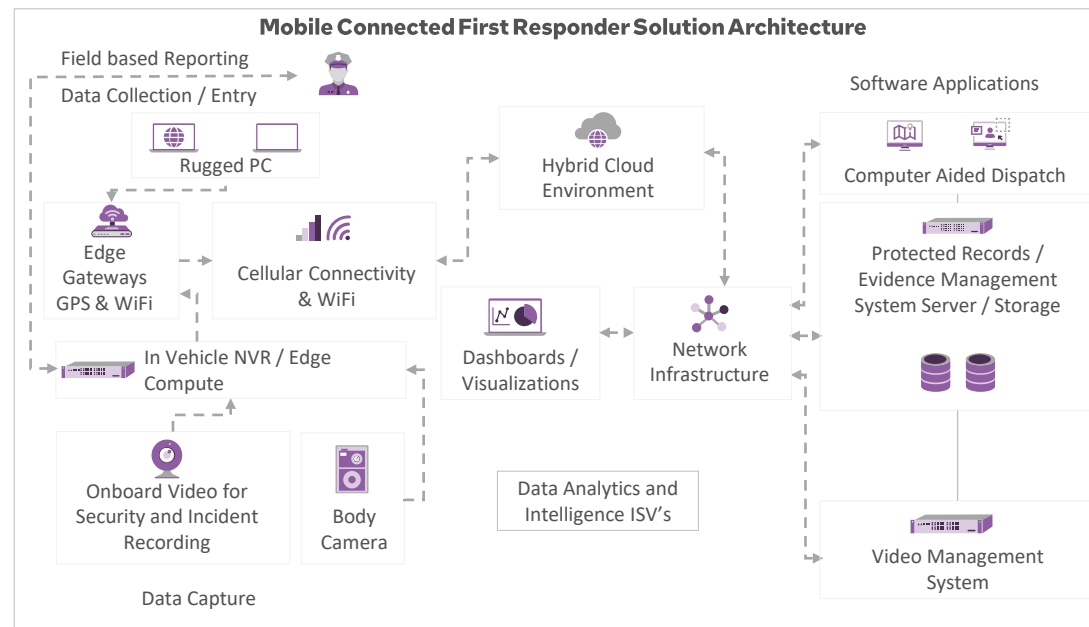

**Target Vertical:**  
Government

**Secondary Verticals:**  
Transportation; Utilities & Energy; Construction

**Target Use Case:**  
Situational Monitoring

**Secondary Use Case:**  
Asset & Operations Optimization

**Geo Availability:**  
Americas

**Sales Contact:**  
rescue911@tdsynnex.com

**Solution Webpage:**  
TD SYNnex | Website homepage



# Teladoc Health TV Pro

## Solution Overview

Teladoc Health TV Pro is a high acuity solution used in ICUs and similar environments to enable a remote clinician to be virtually present with the patient and onsite clinicians in support of that patient's care.

## Value Props



Improve access to healthcare with detailed examinations and patient monitoring from a distance



Reduce costs with a solution that can leverage any HDMI-enabled TV and scale the ability to provide patient care



Deploy quickly and efficiently as TV Pro is easily assembled and fully functional in a matter of minutes

## Intel Components

Intel® NUC

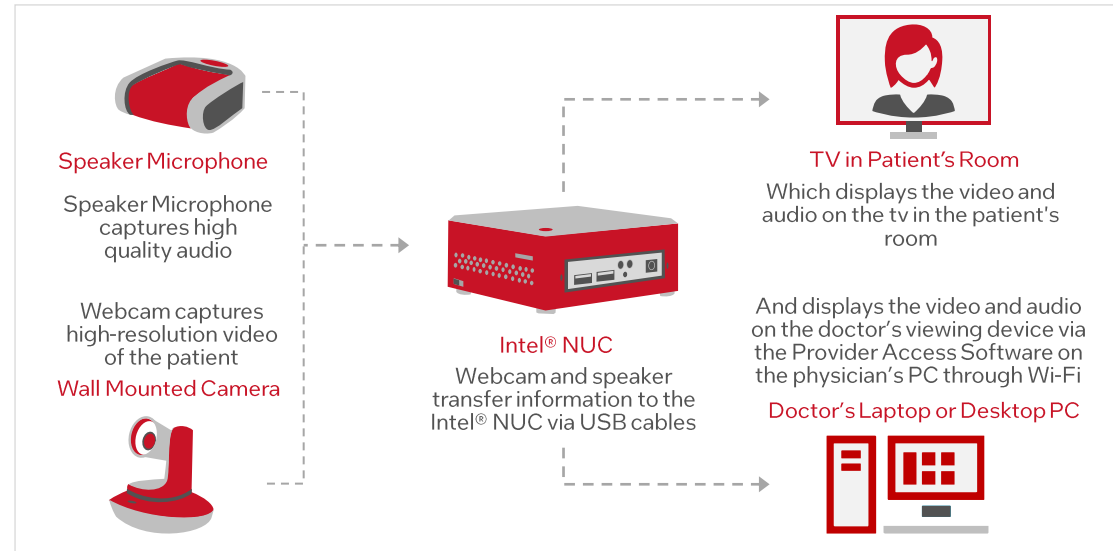

**Target Vertical:** Health and Life Sciences

**Target Use Case:** Human Wellness Monitoring

**Secondary Use Case:** Interactive Media, Situational Monitoring

**Geo Availability**  
US, EMEA, APAC

**Learn More**  
The Teladoc Health Hospital & Health Systems Webpage

# TELELOGOS Media4Display

## Solution Overview

The Telelogos Media4Display software solution helps companies provide the right content to the right people at the right time with digital signage tools. Customers import media and create their own dynamic content in real-time to various locations on screens, tablets, kiosks, etc.

## Value Props

- Create dynamic content and easily import media to increase end user engagement
- Manage, assemble, plan, and organize and content to deliver the right message to the right person at the right time
- Display content on screens, tablets, kiosks; centrally manage all displays, screens, devices to maximize uptime.

## Intel Components

Intel® NUC

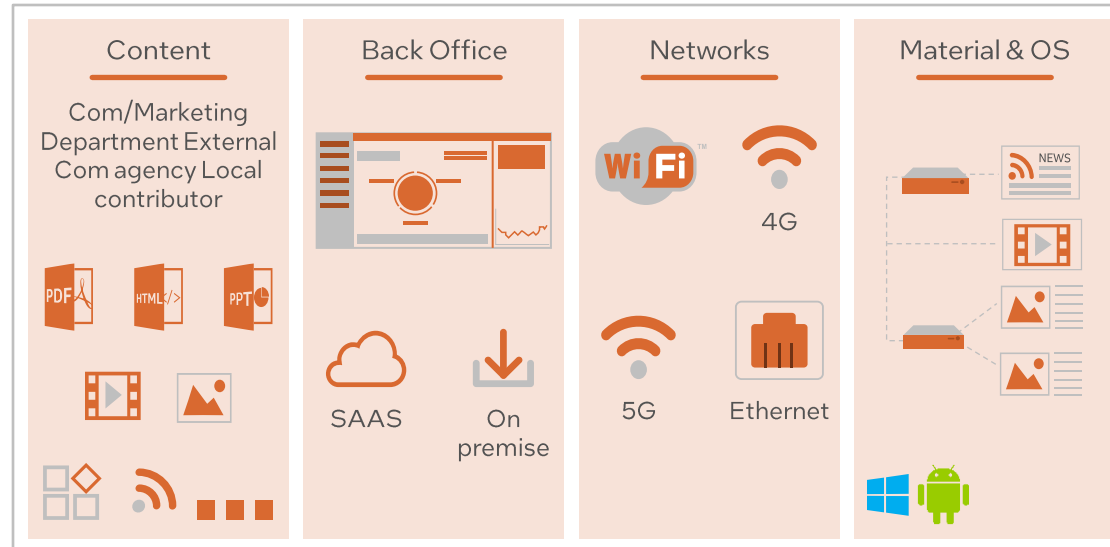

**Target Vertical:** Corporate, Retail

**Secondary Verticals:** Banking/Financial Services; Education; Public Places & Entertainment; Government. Manufacturing, Transportation & Logistics, Healthcare, QSR, DOOH

**Target Use Case:** Interactive Media, Customer experience-external communication, Worker engagement-internal communication

**Secondary Use Cases:** Smart Workplace; Digital Manufacturing & Dashboarding

**Geo Availability**

Globally

**Learn More**

- [Telelogos Website](#)
- [Media4Display Webpage](#)



TELESOFT

# Telesoft TDAC

[Back to Government Solutions](#)

[Back to Situational Monitoring Solutions](#)



## Solution Overview

Due to CAPEX and OPEX limitations, many cyber protection systems cut corners when securing their networks. Businesses need a solution to manage increased data rates at the Edge and detect cyber threats from increased system complexities. Telesoft developed an information security solution to encrypt increased data rates and monitor system usage. The Telesoft TDAC solution secures network operations with comprehensive, proactive cyber security capabilities that provide full unsampled network monitoring and analytics. This solution strengthens cyber posture and unlocks data for efficiency, compliance, and risk management.

## Value Props



**Secure network operations** with scaled, carrier class cyber hardening of edge to hybrid cloud environments without typical elevated risk trade-offs associated with CAPEX and OPEX limits



**Increase revenue-generating services** by investing in scaled cyber systems



**Lower future risk and liability** by gaining proactive cyber capabilities rather than reactive-only defense

## Kit Components

- Intel® FPGA Products
- Intel® Xeon® Processors
- Intel® Solid State Drives (SSD)

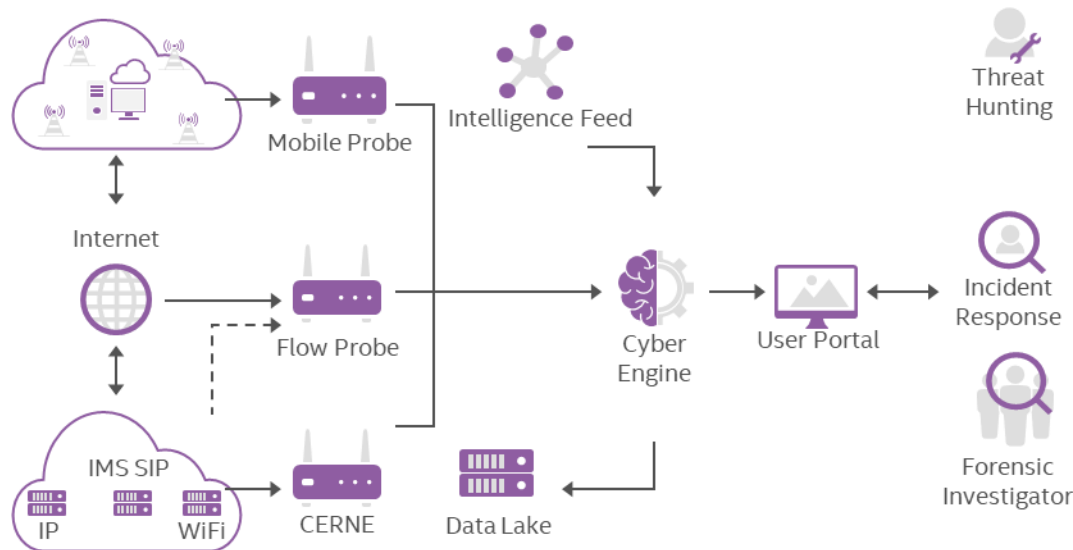

### Primary Vertical:

Government

### Partner Primary Verticals:

Telco, SI, OEMs, CDNs, Managed services, VLN's

### Secondary Vertical:

Energy, Gaming & Entertainment, Hospitality, Manufacturing, Retail, Transportation  
Partner Secondary Vertical: Enterprise

### Target Use Case:

Situational Monitoring  
Secondary Use Cases: Asset & Operations Optimization, Environmental Monitoring

### Geo Availability

US, India, Germany, UK

### Learn More

- [Telesoft Website](#)







# Theatro Intelligent Voice Assistant for the Frontline Workforce

## Solution Overview

Theatro Intelligent Voice Assistant for the Frontline Workforce is an end-to-end solution that extends essential enterprise communication to the entire frontline workforce. In today's world, mobile connectivity is an essential requirement for effective, efficient, and safe operations at the front line and across the enterprise.

## Value Props

-  Increase workforce productivity by reducing wasted labor due to communication friction between HQ, Field Leadership, and local teams
-  Drive employee engagement by connecting every associate and providing immediate information
-  Deliver better customer experience via stronger employee engagement and execution
-  Ensure safe operations in a post-COVID world by enabling remote communication and leadership

## Intel Components

Intel® Core™ i5, VM or physical

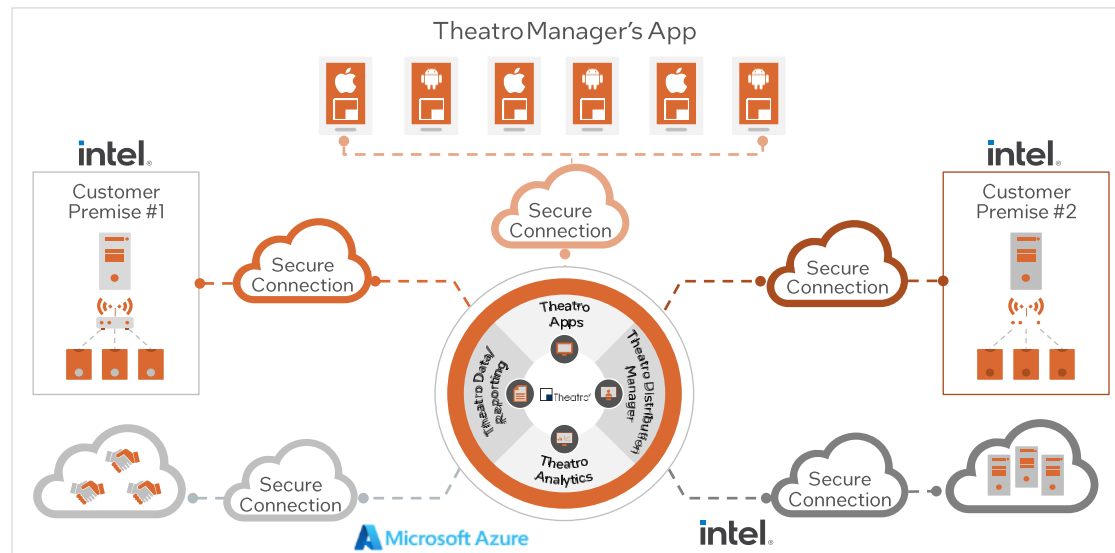

Target Vertical: Retail

Target Use Case: Asset & Operations Optimization

Geo Availability

Available in US and Canada

Learn More

- [Theatro Website](#)
- [Theatro Resources](#)
- [Theatro Videos](#)



# TITANUSEYEoT DSS

[Back to Government Solutions](#)

[Back to Situational Monitoring Use Cases](#)



## Solution Overview

An IoT-based intelligent video monitoring solution designed to be easily integrated, highly extensible, fully customizable, and compatible with other security applications to help customers protect public safety and assets

## Value Props



Protect people and assets with a solution that supports large-scale video surveillance



Enable data-driven actions with the capability to perform multiple concurrent analyses



Connect legacy video solutions with a solution supporting hybrid video

## Intel Components

- Intel® Core™ i3 processor
- Intel® Core™ i7 processor
- Intel® Core™ i5 processor
- Intel® Xeon® E3 processor

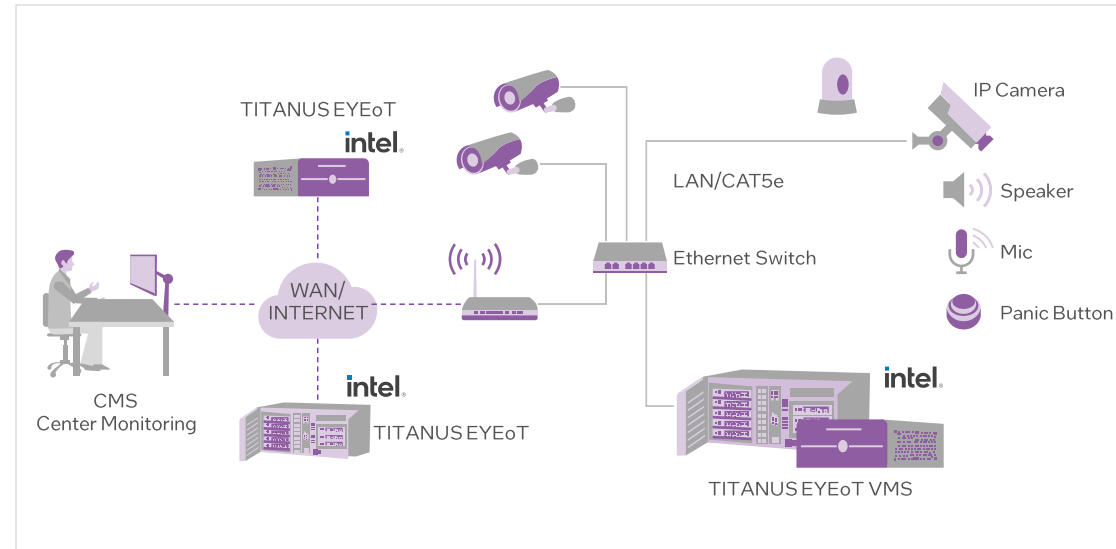

**Target Vertical:**  
Government

**Target Use Case:**  
Situational Monitoring

**Geo Availability**  
SE Asia

### Learn More

- [TITANUSEYEoT Intel Solutions Marketplace](#)
- [Gamma Solution official Facebook page](#)



# Toshiba Self Service Retail Total Solutions

## Solution Overview

The Toshiba Self Service Retail Solution systems represent the next generation of self-checkout kiosks. With robust performance and exceptional reliability, these systems enable retailers to provide convenient, enjoyable, hygienic experiences for shoppers. The System 7 and Pro-X Hybrid Kiosks, and TCx 800 models are equipped with Toshiba's advanced & proven software CHEC: a management suite developed to help retailers test, measure, control, and optimize performance across their sales network.

## Value Props

- Deliver excellent customer experiences** through a range of configurations that meet needs of modern customers' and expedite transactions
- Streamline in-store operations** through hardware and software solutions that connect customers with assistance and helps employees prioritize time
- Minimize the costs-to-business** of digital transformations by reducing expenses through a system designed for seamless integration, scalability, and durability

## Kit Components

- Vision Accelerator Design with Intel® Movidius™
- Intel® Core™ i3, i5, i7 Celeron® Processors
- Intel® Distribution of OpenVINO™ Toolkit

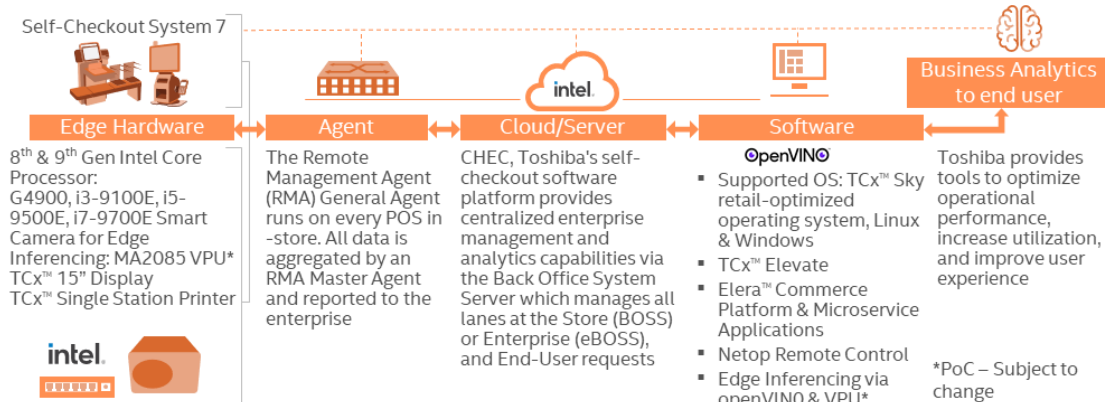

### Solution Components

#### Intel Components

- Vision Accelerator Design with Intel® Movidius™
- Intel® Distribution of OpenVINO™ Toolkit
- Intel® Core™ i3, i5, i7 Celeron®

#### Toshiba Hardware†

- Scanner
- Edge device and housing
- Toshiba CHEC software

†Hardware, housing, and software is system configuration dependent

#### Cloud Service Provider

- Private/On-Prem

**Target Vertical:**  
Retail

**Secondary Vertical:**  
Hospitality

**Target Use Case:**  
Interactive Media

**Secondary Use Case:**  
Asset & Operations Optimization

**Geo Availability**  
ANZ, EU, Canada, Switzerland, UK, US, Turkey, LATAM

### Learn More

- [Toshiba POS | Systems & Applications](#)
- [Toshiba System 7 | Product Video](#)
- [Toshiba CHEC | Product Documentation](#)



# Toshiba TCx™ 800 All-In-One POS and Remote Monitoring In-Store Experience

## Solution Overview

The TCx™ 800 all-in-one POS platform enables associates to deliver quick, enjoyable experiences for shoppers. As a fully functional POS system, kiosk, or self-service unit, the TCx™ 800 POS platform combines powerful performance and exceptional reliability

## Value Props

- Deploy easily** with an adaptable solution based on available in-store space
- Improve productivity** with a solution that uses a familiar interface
- Enhance customer experience** with quicker checkouts and a more responsive, reliable platform

## Intel Components

- Intel® Celeron® Processors
- Intel® vPro® Platform
- Intel® Core™ i3, i5, and i7 Processors

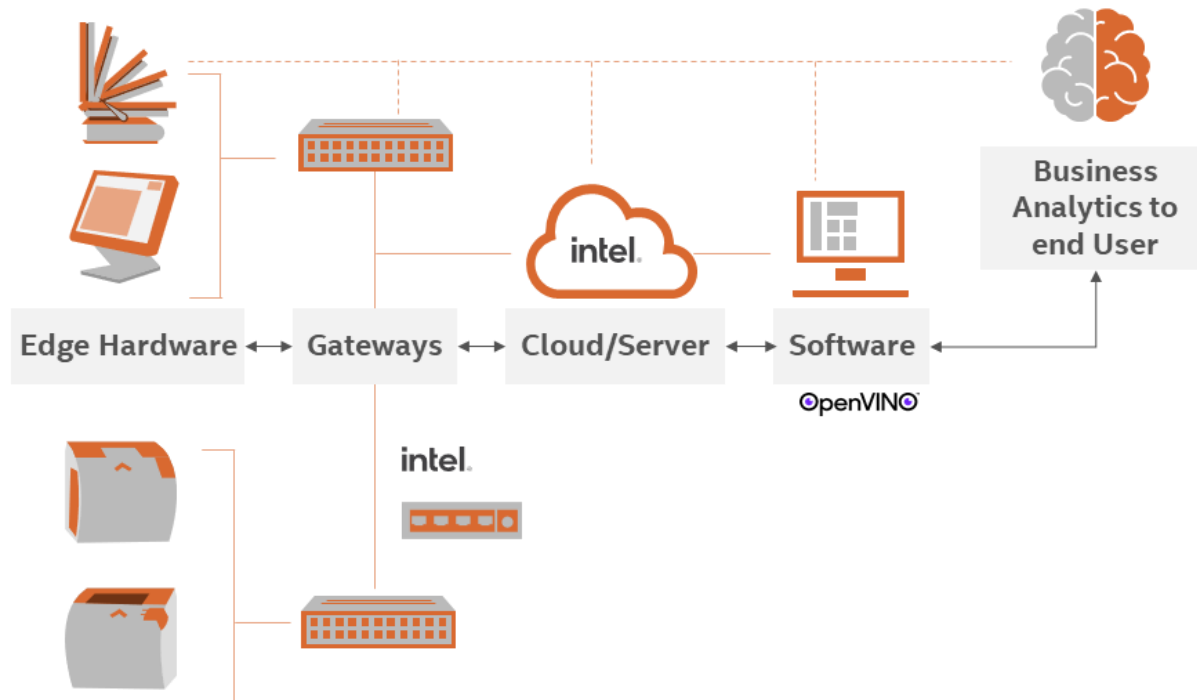

**Target Vertical:**  
Retail

**Target Use Case:**  
Interactive Media

**Secondary Use Case:**  
Asset and Operations Optimization

**Geo Availability**  
North America, South America, Europe, Middle East & Africa, APJ

### Learn More





- [Toshiba Website](#)
- [Edison White Paper](#)
- [Comparing Toshiba all-in-one POS platform against its competitors](#)
- [TCx™ 800 Datasheet](#)

# Touch Cloud AI@Sense LPRS

## Solution Overview

Without fence or gate systems to keep traffic slow, many parking lots struggle to efficiently implement accurate license plate recognition. To address these issues, the Touch Cloud AI@Sense LPRS, using Intel® OpenVINO™ technology, detects and recognizes license plate images to support a variety of scenarios including real-time LPR for parking lots, vehicle access control, traffic enforcement, and additional transportation situations. Transportation customers can easily and remotely deploy the solution to increase visibility and overall operational efficiency.

## Value Props

-  Experience high-accuracy vehicle plate recognition in various scenarios with a solution that can adapt to conditions like rain, shadows, different license plate angles, and high vehicle speeds
-  Enhance visibility into vehicles on premises with remote viewing options and robust backend searchability for operators
-  Improve operational efficiency through real-time, automated license plate data capture, enabling faster decision making and reduced manual workloads for vehicle tracking and access control
-  Enjoy quick, low-touch deployments with a plug-and-play system that can be remotely set up and only requires a minimum connection between existing IP cameras and the Touch Cloud AI@Sense platform

## Intel Components

- Intel® Core Processors
- Intel® Xeon® Processors
- Intel® Distribution of OpenVINO™ toolkit

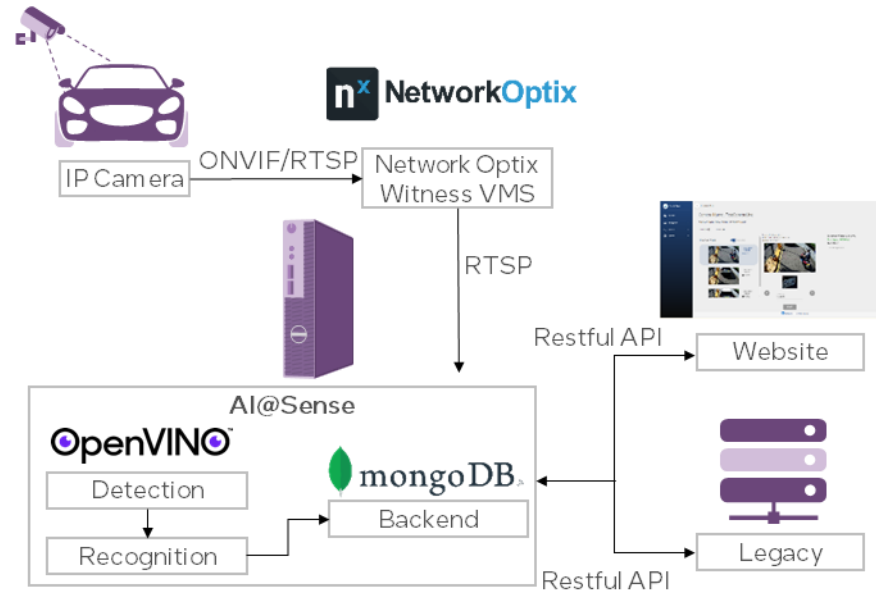

Target Vertical:  
Transportation

Secondary Vertical:  
Government, Hospitality, Manufacturing, Retail

Target Use Case:  
Logistics & Tracking

Secondary Use Cases:  
Control Optimization & Autonomy

Geo Availability  
Asia, Pacific, and Japan

Learn More

- [Touch Cloud Homepage](#)

# Touch Cloud/WPI TC Telescope

## Solution Overview

A computer vision surveillance solution designed to capture objects and human behaviors in real-time within a designated construction zone for monitoring and security purposes. The solution effectively and detects people and traffic movement to provide site safety and security.

## Value Props



Increase worker safety by recognizing PPE violations in construction zones



Enhance security by surveilling designated areas and detecting abnormal objects



Improve business logic via incident analysis of stored video footage

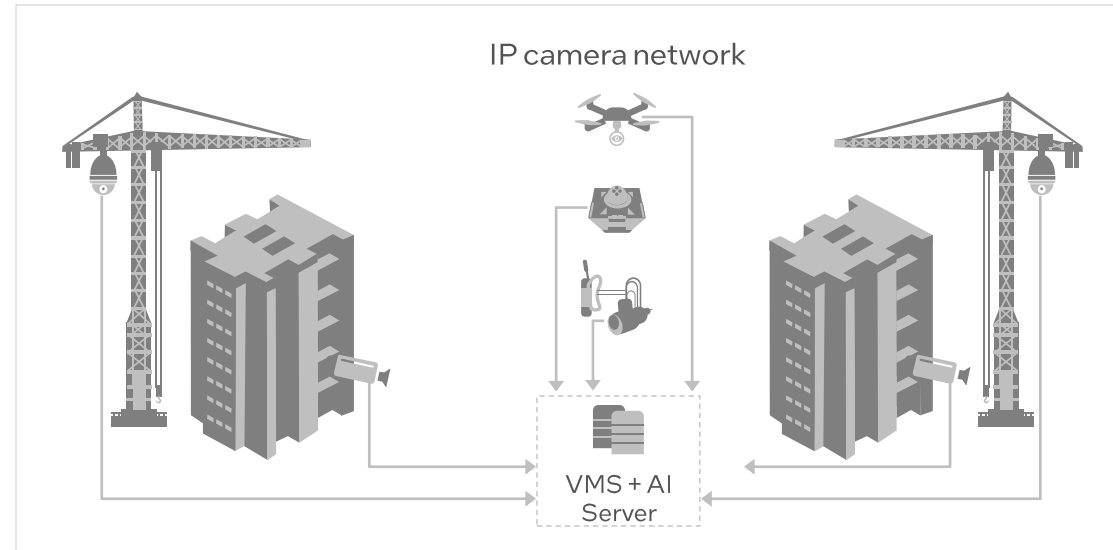

## Intel Components

- Intel VPU
- Intel® Distribution of OpenVINO™ toolkit
- Intel® Core™ Processors

**Target Vertical:**  
[Manufacturing](#)

**Target Use Case:**  
[Situational Monitoring](#)

**Secondary Use Cases:**  
[Asset & Operations Optimization](#), [Product Inspection](#), [Human Wellness Monitoring](#)

**Geo Availability**  
Available in APJ

**Learn More**

- [Touch Cloud Homepage](#)





# Touch Cloud Abaci – The Realtime Flow and Crowd Counting Solution

## Solution Overview

The Touch Cloud Abaci Realtime Flow and Crowd Counting Solution enables people counting in buildings and public transportation settings. This solution utilizes real-time analytics that enables better resource management and can improve operational efficiencies.

## Value Props

-  Enhance resource management by leveraging crowd counting capabilities
-  Promote improved safety measures with real-time analytics that provide insight into capacity of specific areas
-  Improve operational efficiencies via plug-and-play functionality that reduces setup time and can report analytics within ten minutes of setup

## Intel Components

- Intel® Core™ i5 Processors
- Intel® Distribution of OpenVINO™ Toolkit

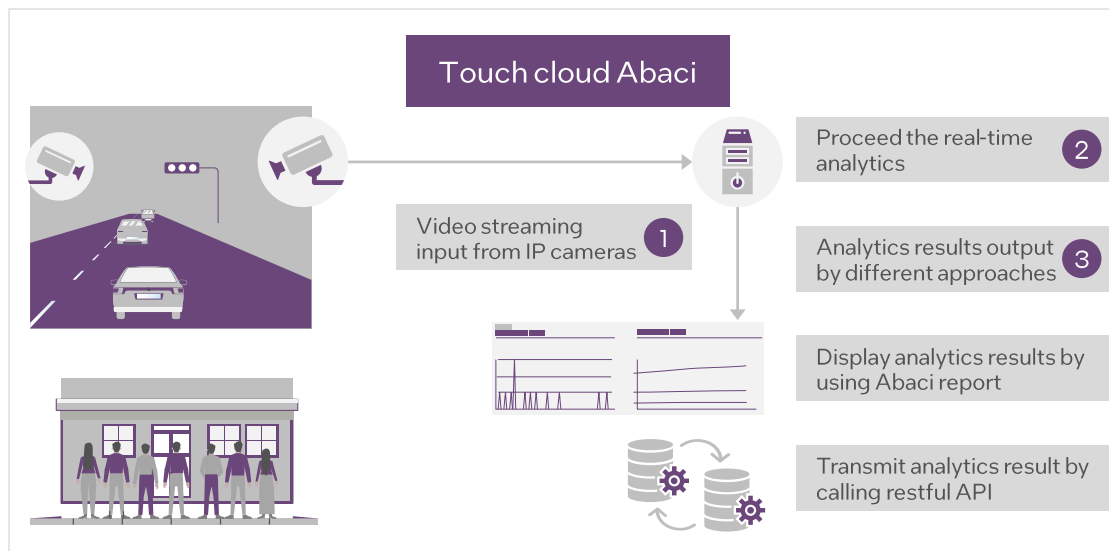

**Target Vertical:**  
Transportation

**Secondary Vertical:** Retail

**Target Use Case:** Asset & Operations Optimization

**Secondary Use Case:** Interactive Media

### Geo Availability

Available in Japan, South Korea, Taiwan, Southeast Asia

### Learn More

- [Touch Cloud website](#)

# Touch Cloud Inc. Portable Smart Construction Site Surveillance and Event Detection System

## Solution Overview

The Portable Smart Construction Site Surveillance and Event Detection System is designed to solve safety problems on construction sites. The system uses wirelessly connected network cameras to collect streaming data from construction sites to detect and recognize safety violations as they occur, all without a fixed power source. Alarms are triggered and the violation event is then displayed on the web platform for supervisors to monitor. This ensures that supervisors are made aware of potential dangers and can act to prevent incidents before they occur, limiting the likelihood of accidents and injury. When compared to manual monitoring, this approach reduces fatigue and errors in supervisory personnel by concentrating all monitoring to one holistic online event platform and sending real-time alerts, further ensuring construction site safety.

## Value Props



**Help improve safety and compliance** at construction sites by detecting potential hazards before incidents occur, helping to protect workers from injury



**Enable flexibility and efficiency** with a solution that is portable and easy to deploy in a variety of job environments, maximizing productivity



**Enable holistic management** using an online event platform to apprise supervisors of potential hazards across many job sites simultaneously

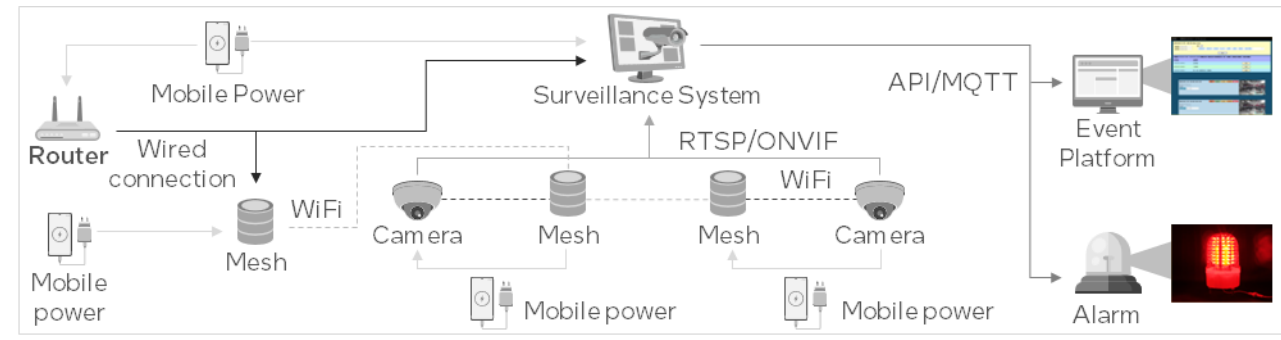

## Intel Components

- Intel® Core™ i7 processors
- Intel® Core™ i9 processors
- Intel® Distribution of OpenVINO™ toolkit

**Target Vertical:**  
Manufacturing

**Secondary Vertical:**  
Government

**Target Use Case:** Asset & Operations Optimization

**Secondary Use Case:** Control Optimization & Autonomy

**Geo Availability:** Asia, Pacific, and Japan

**Sales Contact:**  
Simon Lee - [simon.lee@touchcloud.com](mailto:simon.lee@touchcloud.com)  
[touchcloud.com](http://touchcloud.com)

**Solution Webpage**

- Touch Cloud Website

# TouchSource Digital Directory Experience

## Solution Overview

The TouchSource Digital Directory Experience delivers captivating digital displays and IoT-connected directory solutions to improve the interactions with tenants, visitors, patients, and retail shoppers. The approachable, interactive technology provides simple, affordable, and easy-to-own digital directories in a various smart buildings.

## Value Props



**Empower your team** with access to the TouchSource digital content system on various platforms for fast, self-service updates anytime



**Leverage data-driven insights** from TouchSource solutions to win new tenants and improve building operations



**Enhance visitor and tenant experiences** with indoor and outdoor digital display solutions to deliver compelling and customized interactions

## Kit Components

- Intel® Core™ i7 Processors
- Intel® Core™ i5 Processors
- Intel® Celeron® Processors
- Intel® Core™ i3 Processors

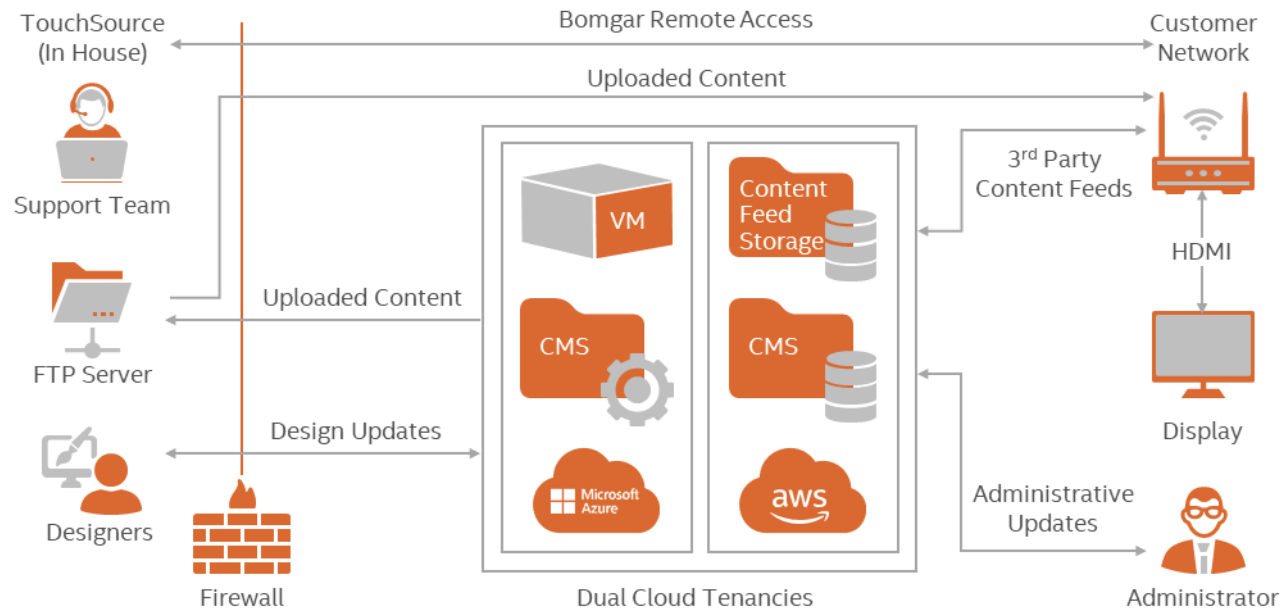

**Target Vertical:**  
Retail

**Secondary Vertical:**  
Hospitality

**Target Use Case:**  
Interactive Media

**Geo Availability**  
North America

**Learn More**

- [TouchSource Website](#)



## Trison signage.ninja

### Solution Overview

The market for digital signage is increasingly competitive and companies are looking for solutions that form a cohesive digital landscape to help execute their messaging strategy. Trison UK's signage.ninja is a state of the art, cloud-based, campaign management and business intelligence solution that enables users to connect and modify their digital signage assets in a highly accessible user interface. The solution supports remote changes, automatic real-time updates, and highly granular scheduling options that can be deployed and customized across any number of screens and storefronts. Moreover, signage.ninja provides in-store retailers with tools to collect and analyze valuable customer data, enabling them to improve the customer journey by aligning with demographics, behaviors, and other various customer needs.

### Value Props



**Increase operational efficiency** by reducing the time and expertise required to execute a successful and cohesive in-store messaging and marketing strategy



**Increase revenue** by leveraging analytic and customer data to effectively implement targeted services and advertisements



**Create consistent messaging** by ensuring corporate messaging is delivered correctly, at the right time, and to the intended workforce and customer base

### Intel Components

- Intel® Distribution of OpenVINO™ Toolkit
- Intel® Celeron® processors
- Intel® Core™ i5 processors
- Intel® Core™ i3 processors

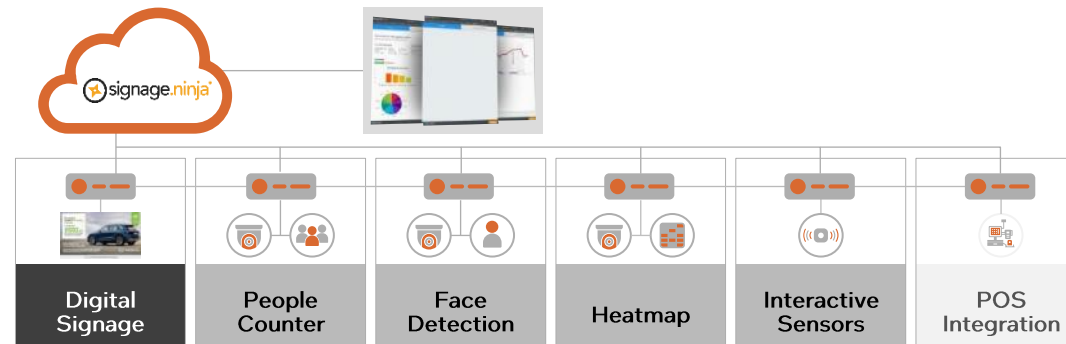

### Target Vertical:

Retail

### Secondary Verticals:

Banking/Financial Services,  
Energy, Gaming & Entertainment,  
Government, Health & Life Sciences, Hospitality, and Manufacturing

### Target Use Case:

Interactive Media

**Secondary Use Cases:**  
Assets & Operations Management

### Geo Availability

Mexico, People's Republic of China, Taiwan, Germany, Middle East, North Africa, Turkey, United Kingdom, United States

### Learn More

- [Trison UK Website](#)

# Trueform Indoor and Outdoor Digital Advertising Displays

## Solution Overview

Trueform Indoor and Outdoor Displays create high quality digital experiences for a wide range of applications from retail to wayfinding and smart cities. Trueform displays are a complete end-to-service, providing hardware, software, and services all designed and manufactured by Trueform.

## Value Props



**Enhance the user experience** with captivating, interactive visual displays that can help increase customer loyalty and drive sales.



**Deploy anywhere** with options for any space, from retail stores to city streets, and the ability to customize solutions based on customer needs.



**Deploy simply and drive solution management efficiency** with comprehensive field services including installation, logistics, project management, maintenance, and remote monitoring.

## Kit Components

- Intel® NUC
- Intel® Core™ i5 and i7 Processors

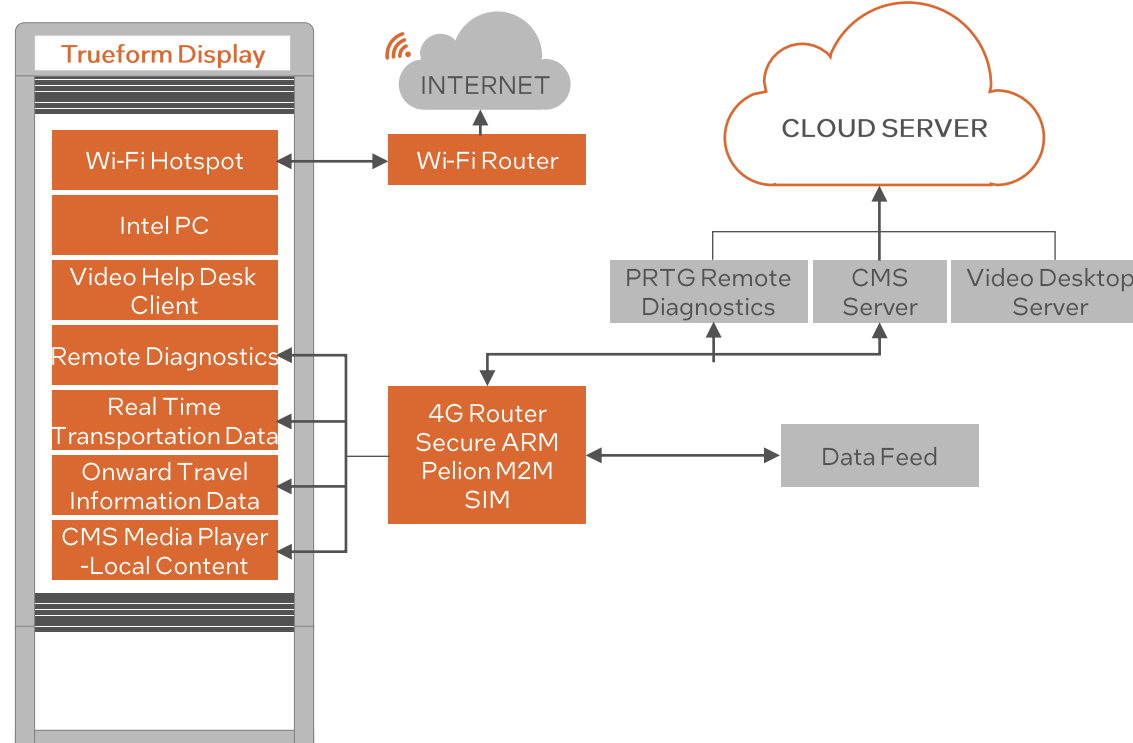

**Target Vertical:**

Retail

**Secondary Verticals:**

Manufacturing,

Transportation, Smart Cities

**Target Use Case:**

Interactive Media

**Secondary Use Cases:**

Environmental Monitoring,

Human Wellness Monitoring,

Machine Condition

Monitoring, Product

Inspection, Situational

Monitoring

**Geo Availability**

Brazil, Canada, Mexico, USA,

Other Americas, Australia,

New Zealand, India, Japan,

South Korea, PRC, Taiwan,

Germany, Israel, Middle East,

North Africa, Turkey, Russia,

Sub-Saharan Africa, UK.

**Learn More**

- [The Trueform Website](#)





# TTTech Industrial Nerve Blue

## Solution Overview

An industrial software platform that consolidates workloads, enabling machine builders to deliver data and offer services to customers anywhere in the world. Nerve Blue allows users to reduce system complexity and cost, improve machine performance, and offer new machine services.

Target Vertical:  
Manufacturing

## Value Props



Collect, store, and analyze machine data to improve machine performance



Consolidate multiple functions on a single device with workload consolidation capabilities that virtualize resources



Manage and deploy software so that customers can offer new machine services

## Intel Components

- Intel® Atom® Processors
- Intel® FPGA Cyclone®

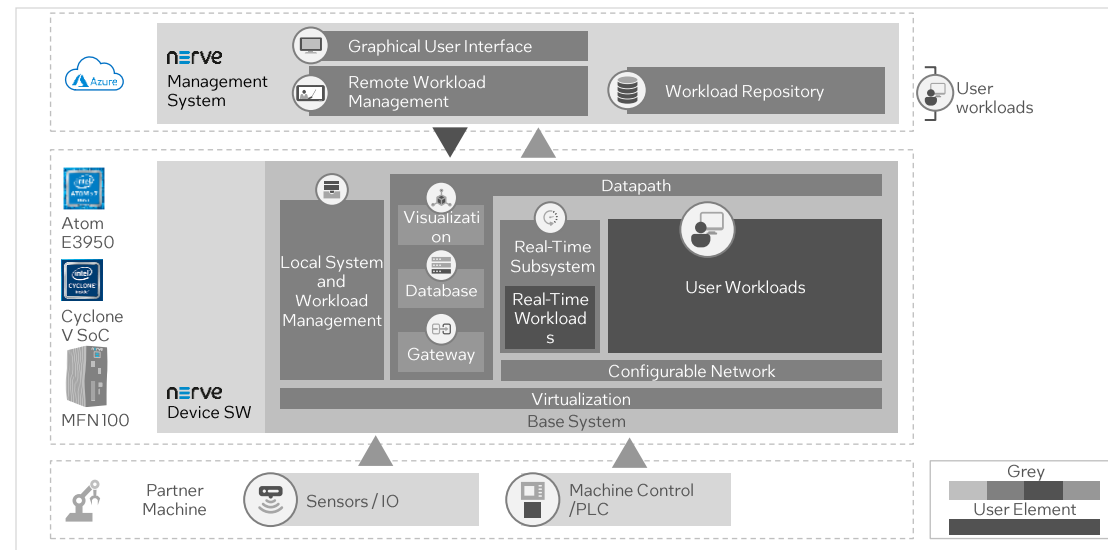

Target Use Case: Asset & Operations Optimization

Secondary Use Case: Machine Condition Monitoring

## Geo Availability

Available in North America, Europe, China, and Japan

## Learn More

- TTTech Industrial Home Page



# Tvarit Industrial AI Solution

## Solution Overview

The Tvarit AI Solution helps businesses decrease quality defect rates in metal coil production and provides complete, intelligent, and connected control over production processes

## Value Props



Optimize overall equipment effectiveness (OEE) for aluminum and metal manufacturing



Improve defect detection accuracy and reduce the number of quality defects



Reduce downtime and waste through root cause analysis

## Intel Components

Intel® Xeon® Processors

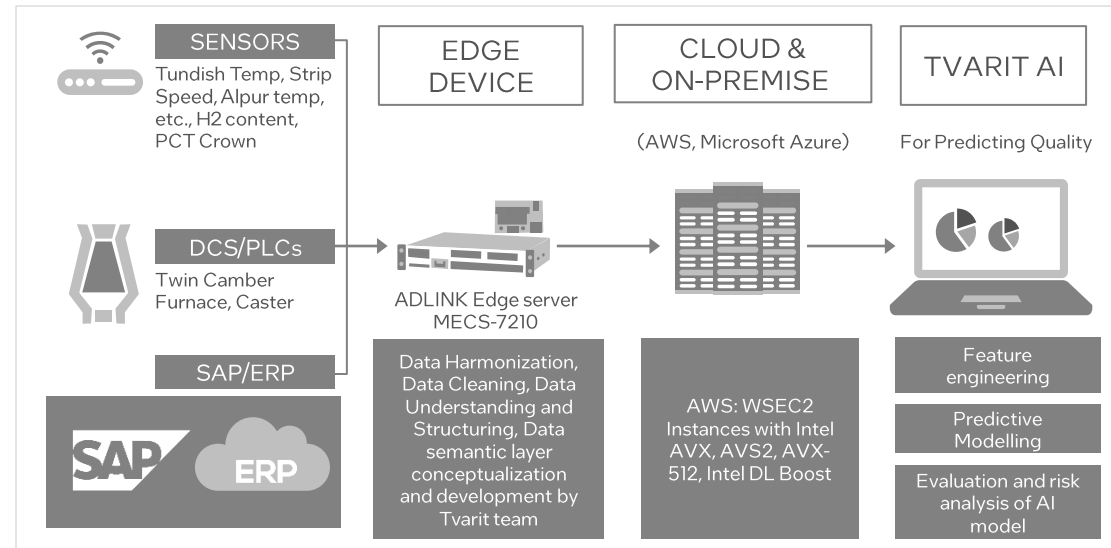

Target Vertical:  
Manufacturing

Target Use Case: Product Inspection

Secondary Use Cases:  
Machine Condition Monitoring, Asset & Operations Optimization

Geo Availability

Available in Germany and India

Learn More

- [Tvarit Website](#)
- [Tvarit AI Video](#)

# UdyogYantra Technologies Food Quality and Quantity Authentication

## Solution Overview

UdyogYantra Technologies' Food Quality and Quantity Authentication solution helps solve the challenge of standardizing the delivery experience throughout an entire kitchen enterprise with the world's first AI-enabled kitchen management system for delivery-focused and "cloud" kitchens.

## Value Props



Centralize quality control by using a solution that digitally supports and monitors every step of food preparation, helping ensure quality standards are met along a variety of parameters like ingredient portioning, food temperature, and order weight.



Simplify operations and reduce costs through a plug-and-play solution that automates inspection to help optimize staff time, reduce waste, and improve service.



Streamline reporting with a platform that can provide customers with quality information and enables managers to drill down by kitchen, product, and more to discover quality insights and maximize comprehensive kitchen efficiency.

## Intel Components

- Intel® NUC
- Intel® Solid State Drives (SSD)
- Intel® Distribution of OpenVINO™ toolkit

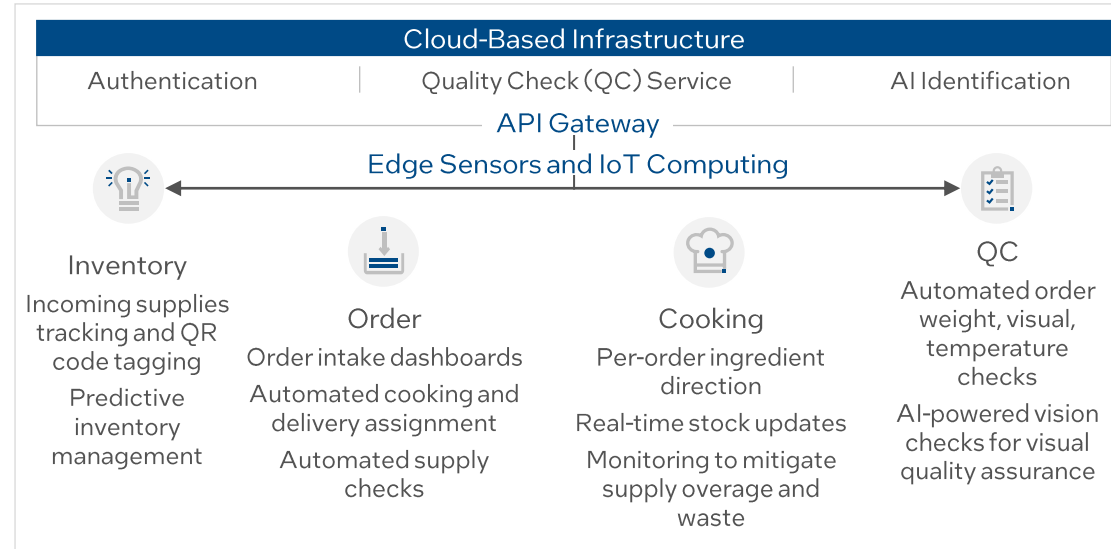

**Target Vertical:** Hospitality

**Secondary Verticals:** Retail, Government, Agriculture

**Target Use Case:** Asset & Operations Optimization

**Secondary Use Cases:** Control Optimization & Autonomy, Logistics & Tracking, Situational Monitoring

## Geo Availability

Southeast Asia, India, Korea, Japan, Taiwan, and North America.

## Learn More

- [Solution webpage](#)
- [UdyogYantra webpage](#)
- [Customer testimony video](#)

## Solution Overview

The Uncanny Vision ANPR solution is an end-to-end AI-based Number Plate Recognition (ANPR / LPR) system with detection and recognition of number plates performed with state of art deep learning technology. Trained with over a million real world samples across multiple nations, the solution delivers high accuracy even in challenging conditions.

## Value Props



Increase operational efficiency by removing the need for manual/labor-based tracking and security



Provide visibility on vehicle movement data for access control and auditing purpose for revenue and non-revenue parking



Improve safety in smart cities by monitoring hot-listed vehicles

Uncanny Vision turns surveillance cameras to edge-based vision sensors

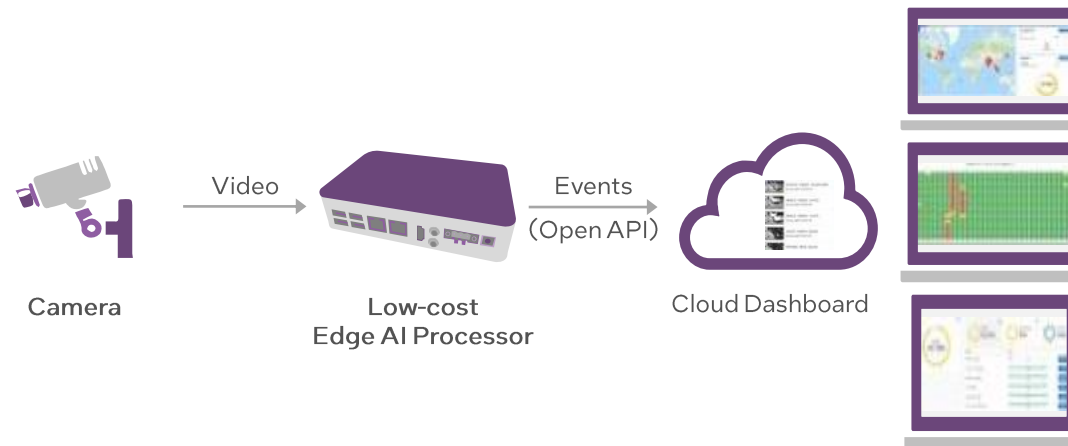

## Intel Components

- Intel® Celeron® Processors N3350/ N4200 Pentium CPU
- Intel® Distribution of OpenVINO™ Toolkit

**Target Vertical:**  
[Transportation](#)

**Secondary Verticals:**  
[Banking/Financial Services](#),  
[Education, Hospitality](#),  
[Public Sector/ Government](#), [Retail](#)

**Target Use Case:**  
[Situational Monitoring](#)

**Secondary Use Case:**  
[Asset & Operations Optimization](#)

**Geo Availability**  
India, US, SEA  
(Southeast Asia)

## Learn More

- [Uncanny Vision Solutions Website](#)
- [ANPR Solution Page](#)

## Solution Overview

The UST ColdTruth solution is a unique cloud-based platform that enables advanced freezer/chiller temperature tracking. UST's solution utilizes IoT sensors attached to freezers or chillers to collect data and allow real-time temperature tracking in order to enhance device efficiency and reduce food waste.

## Value Props

- Increase visibility of device performance**, with sensors capable of tracking real-time temperature from the freezer/chiller at all shelf levels
- Improve response times**, with automated alerts sent to the Store Manager and Maintenance team for quick check-ins
- Elevate data tracking**, with sensors monitoring real-time and historical temperature data of various freezers at different locations

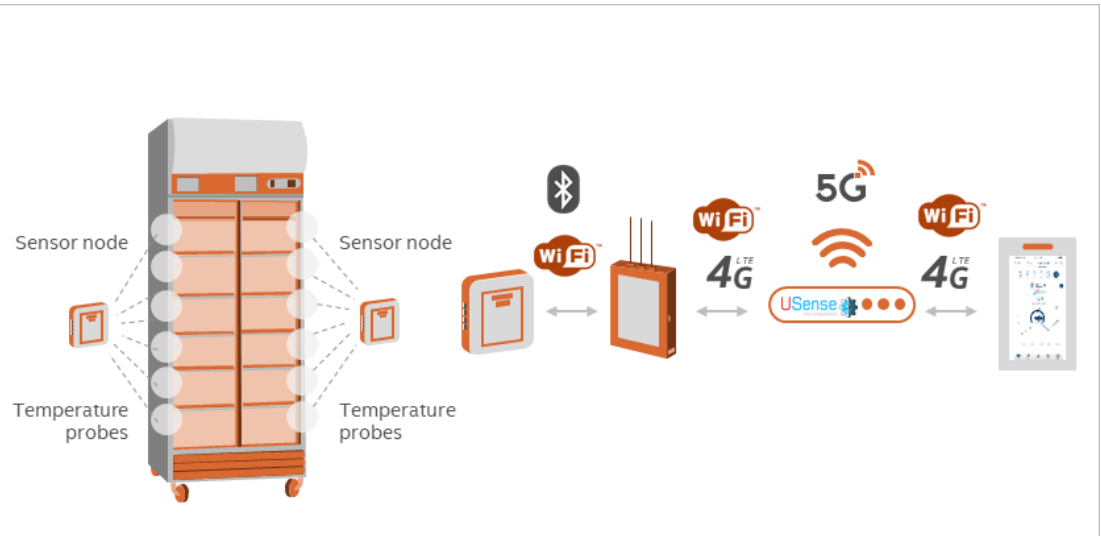

## Intel Components

- Intel® NUC

**Target Vertical:**  
Retail

**Secondary Verticals:**  
Agriculture;  
Banking/Financial Services;  
Health & Life Sciences;  
Hospitality; Manufacturing;  
Transportation

**Target Use Case:**  
Machine Conditioning  
Monitoring

**Geo Availability**  
Canada; Mexico; United States; India; Taiwan; Germany; United Kingdom

**Learn More**  
▪ [UST – home page](#)

# UST Vision Checkout Kiosk

## Solution Overview

Today's customers are increasingly looking for contactless shopping experiences, and to meet the demand for an accelerated checkout process, UST has developed the Vision Checkout Kiosk. The solution is an AI-enabled, smart, touchless checkout system that offers 3x faster self-checkouts powered by computer vision and gesture technology. It utilizes edge computing and AI-enabled hardware to accurately identify items, ring up orders, and accept payment to expedite the checkout process, improving the overall in-store experience.

## Value Props

- Enhance end customer experience** with an intuitive digital interface that quickly and conveniently guides users through the purchasing process
- Optimize checkout process** with a contactless grab-and-go service system that automates product detection and increases checkout efficiency
- Reduce operational costs** with access to downloadable inventory reports that improve record keeping and enable retailers to scale their resources accordingly

## Kit Components

- Intel Components
- Intel® Core™ Processors
- Intel® Distribution of
- OpenVINO™ toolkit
- Intel® NUC
- Intel® RealSense™ Depth
- Camera D415
- Intel® Edge GPU Server

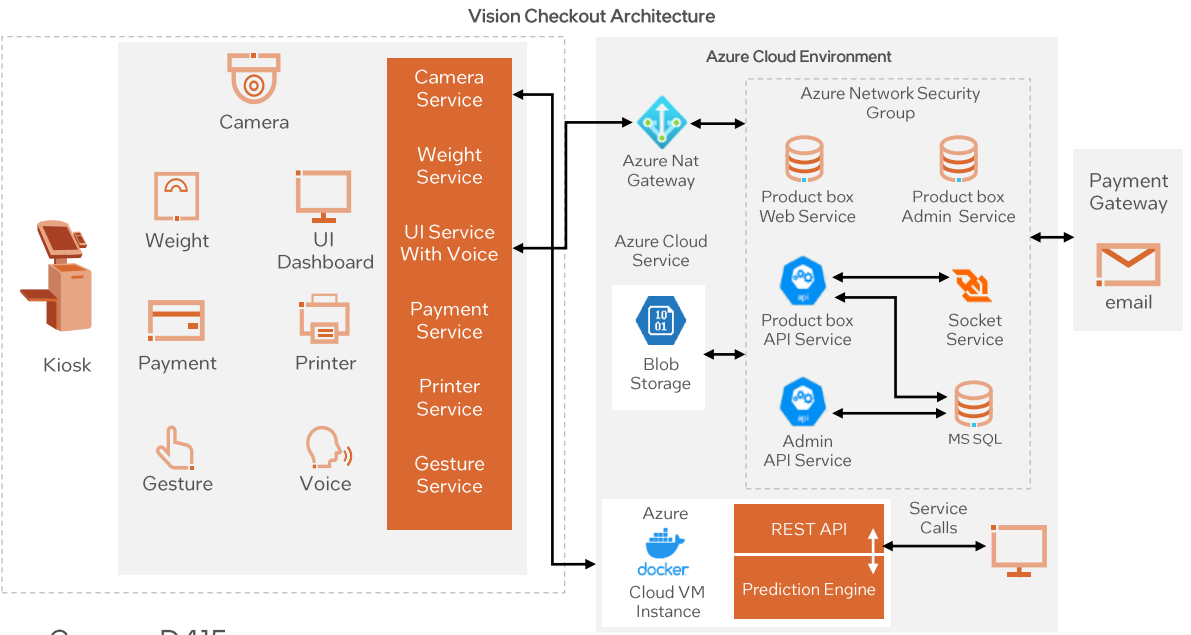

**Target Vertical:**  
Retail

**Secondary Verticals:**  
Hospitality and Restaurants,  
Cruise Industry, Healthcare

**Target Use Case:**  
Interactive Media

**Geo Availability**  
Asia, Pacific, Japan,  
Americas, Europe, Middle East

**Learn More**  
▪ UST – Home page

# UST Global: Retail Analytics for Covid-19 and Beyond

## Solution Overview

The UST Global Retail Analytics for Covid-19 and Beyond solution helps provide a safe shopping experience for customers in the store by analyzing the videos from store security cameras, empowering store managers with near real-time visibility of customer count and enables proper implementation of social distancing and hygiene practices to create a safer space for customers.

## Value Props



Address regulatory compliance by tracking implementation of social distancing guidelines for safe shopping in stores



Identify 'hot zones' where there is no social distancing, and identify sanitation needs in areas where there is frequent touching

## Intel Components

- Intel® Media SDK
- Intel® Distribution of OpenVINO™ toolkit stack
- Intel® Edge stack

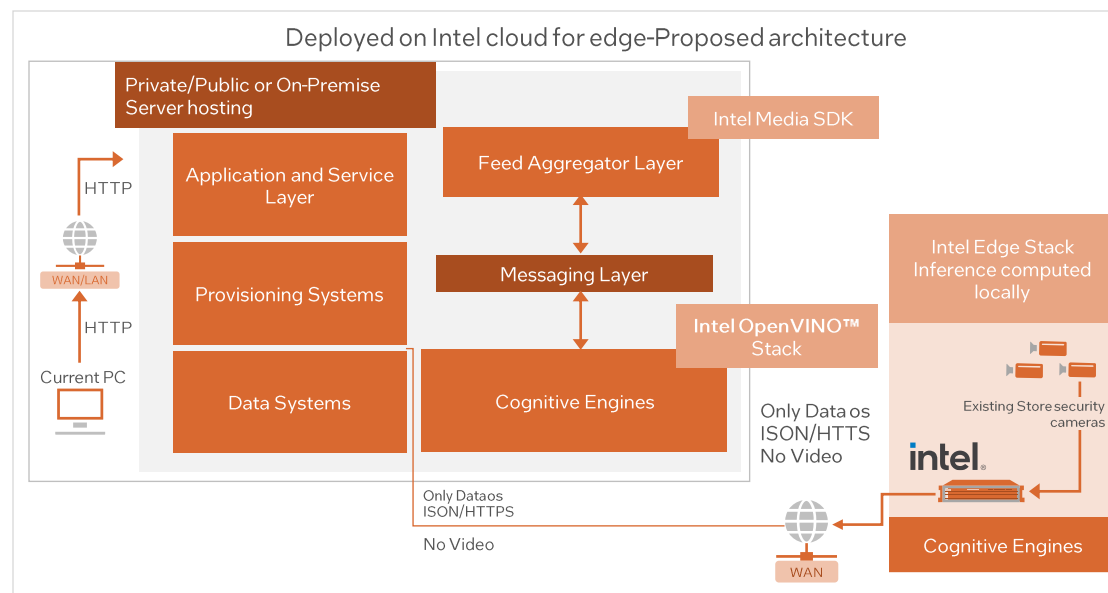

Target Vertical: Retail

Target Use Case: Situational Monitoring

Geo Availability

Available in US, Europe and APAC

Learn More

The UST Global website

# UST Vision Intelligence Box

Back to Retail Solutions

Back to Situational Monitoring Solutions



## Solution Overview

The UST Vision Intelligence Box provides safe experiences for customers and employees by analyzing videos from overhead security cameras. This solution enables real-time visibility of customer count, implementation of social distancing norms and ensures hygiene practices are being followed. All data is collected and managed through on-prem edge computing servers. The solution offers real-time analytics without storing customer images in the video feed; therefore, in compliance with the GDPR and the California Consumer Privacy Act of 2018.

## Value Props



**Increase operational efficiency**, with a solution that can provide accurate, real-time data and alerts



**Enhance customer experience**, by leveraging customer journey map data to best anticipate and respond to consumers



**Improve safety and security**, with a solution that enables powerful tools for security and hygiene detection

Private/Public cloud or On-Premise Serve hosting

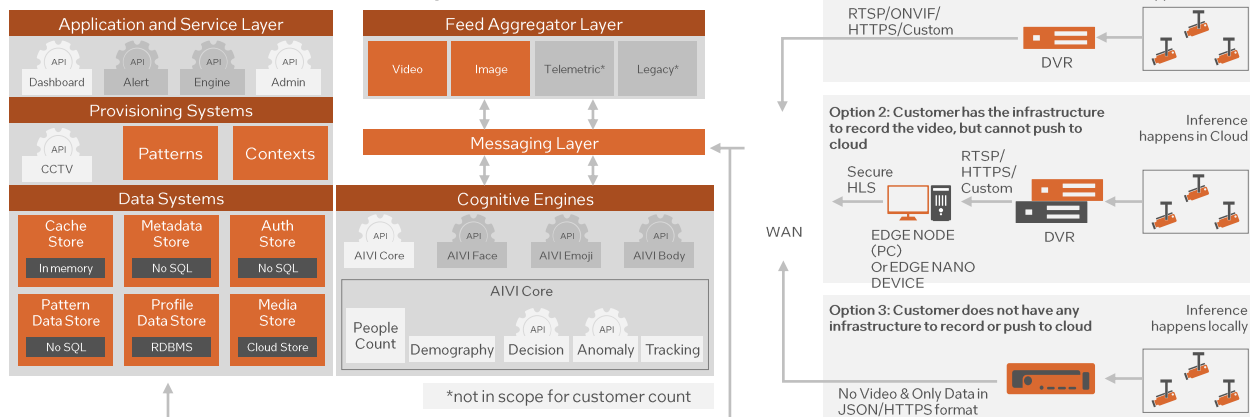

**Target Vertical:**  
Retail

**Target Use Case:**  
Situational Monitoring

**Geo Availability:**  
United States, Europe, and APAC

**Learn More**

▪ [UST – Home page](#)

## Kit Components

- Intel® Distribution of OpenVINO™ toolkit
- Intel® RealSense™
- Intel® Movidius®
- Intel® Core™ i7 Processors
- Intel® Core™ i5 Processors
- Intel® Xeon™ Processors

- Intel® VPU







## Solution Overview

Vaelsys V4 is an AI-powered video analytics software platform that enables users to implement efficient, automated, and customizable safety and security solutions. V4 identifies and categorizes people, objects, vehicles, or actions in real-time. Based on the data gathered, it sends programmed responses with relevant footage to the appropriate party and triggers automated responses. V4 is designed as an open platform, making it compatible with any camera regardless of the manufacturer, and supports seamless integration by converting images into easy-to-use data that ensures functionality with different types of software.

## Value Props



**Increase operational efficiency** by intelligently leveraging security video footage and implementing automated and customizable security protocols that decrease response times, improve detection accuracy, and increase monitoring range



**Help enhance security** with tools to provide user-specific surveillance capabilities such as tracking visual and thermal analytics, displaying maximum detection distances, monitoring unlimited intrusion zones, and specific post detection protocols



**Reduce labor costs** by decreasing the amount of hired security needed to monitor and analyze video footage to effectively execute the appropriate security responses

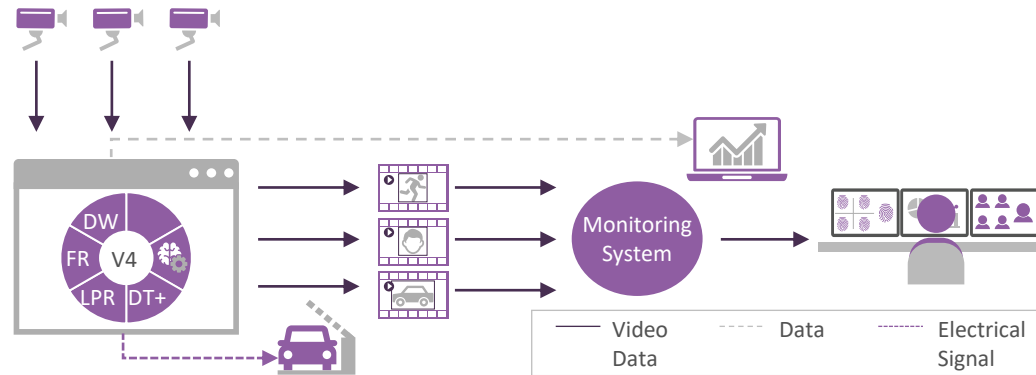

## Intel Components

- Intel® Atom® Processors
- Intel® Core™ i3, i5 and i7 Processors
- Intel® NUC
- Intel® Xeon® Processors
- Intel® Distribution of OpenVINO™ Toolkit

**Target Vertical:**  
Government

**Secondary Verticals:**  
Banking/Financial Services,  
Manufacturing, Education,  
Transportation, and Retail

**Target Use Case:**  
Situational Monitoring

**Secondary Use Cases:**  
Environmental Monitoring,  
Logistics & Tracking, and  
Product Inspection

**Geo Availability**  
Spain, France, Portugal, Italy,  
Ireland, Ecuador, Other  
Americas, and United  
Kingdom

**Learn More**  
▪ [Vaelsys Website](#)



# Vecow VHub AI Fever Scan Solution

## Solution Overview

The Vecow VHub AI Fever Scan Solution is a portable, contactless screening system that manages access control by identifying individuals and detecting high body temperature to help increase end user and staff safety. The solution is equipped with a thermal camera to measure body temperature, AI algorithms to identify individuals with high body temperature, and a portable smart access control unit that manages crowds through an immediate locking system paired with alarm notifications to report and control safety threats in real-time.

## Value Props



**Help increase safety** with an all-in-one solution that can detect and track elevated body temperature of visitors and staff



**Execute efficient body temperature scanning** with a high-accuracy solution to increase staff productivity by allowing them to focus on more valuable tasks



**Help control the spread of infectious disease** with immediate alarm notifications and locking system, enabling businesses to experience high traffic

## Intel Components

- Intel® Core™ i3 & i7 Processors
- Intel® Atom® Processors
- Intel® Xeon Processors
- Intel® Distribution of OpenVINO™ toolkit
- Intel® Movidus™ VPUs

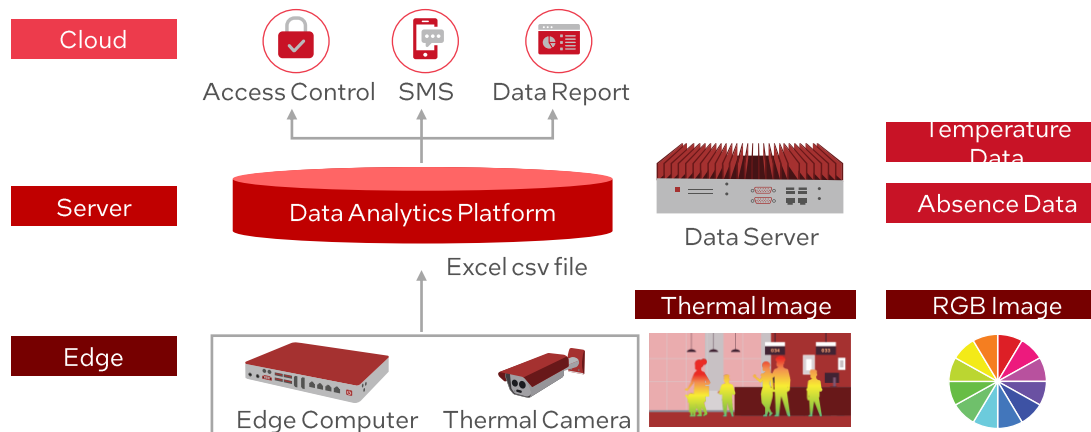

**Target Vertical:**  
Health & Life Sciences

**Secondary Vertical:**  
Education, Government, Hospitality, Retail, Other

**Target Use Case:**  
Human Wellness Monitoring

**Geo Availability**  
United States, Australia, New Zealand, India, Japan, South Korea, People's Republic of China, Taiwan, Germany, United Kingdom

**Learn More**

- [Vecow Solution Website](#)
- [Vecow Website](#)

# Vecow Co., Ltd. Machine to Machine Solution

## Solution Overview

A scalable, cost-effective plug-and-play smart factory solution that enables machine automation and predictive maintenance. The Vecow solution enables smart factories to optimize manufacturing processes, reduce workloads, and maximize efficiency.

## Value Props

- Reduce cost with machine automation that helps customers avoid rework and corrective maintenance
- Maximize productivity with a solution that allows for longer factory work-hours and increased uptime
- Make informed decisions by gathering and analyzing data on machine down time, alarm history, and productivity

## Intel Components

- Intel® Core™ i5 Processors
- Intel® Xeon® Processors

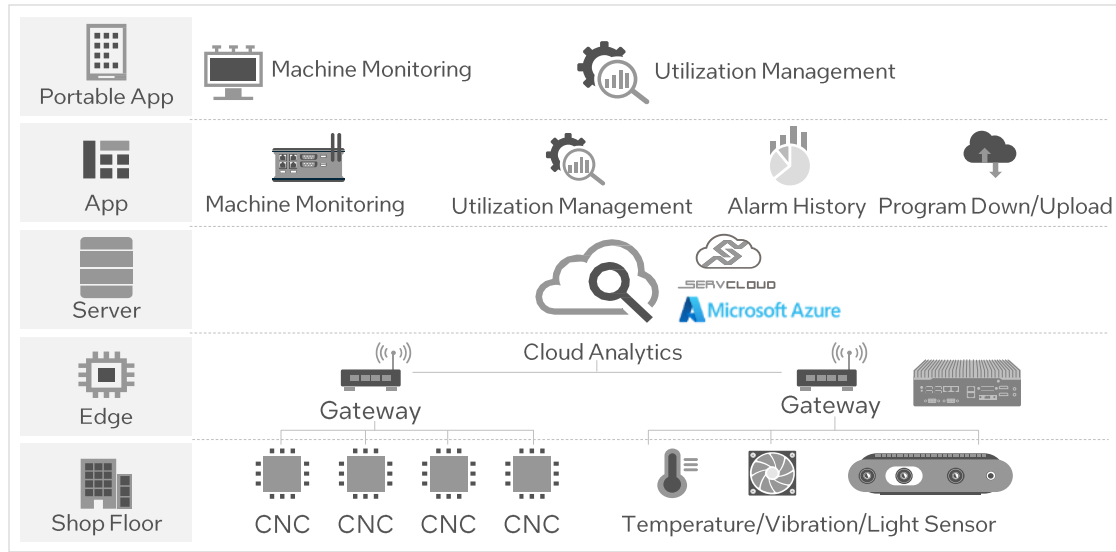

**Target Vertical:**  
Manufacturing

**Target Use Case:** Machine Condition Monitoring

**Secondary Use Cases:**  
Asset & Operations Optimization, Control Optimization & Autonomy

### Geo Availability

Available in Taiwan, China, Thailand, India, Germany, Denmark

### Learn More

- [Vecow home page](#)
- [Cosmos partner page](#)

# Vecow Surface Defect Inspection Solution

## Solution Overview

Vecow Surface Defect Inspection Solution is a cutting-edge physical inspection solution that automates the visual inspection process. This solution collects quality data in real-time while saving costs and improving the false acceptance rate. The solution indicates surface defects on products that conventional machine vision technology would struggle to identify.

## Value Props



Continuously improve defect detection rates by leveraging built-in feedback that reduces potential costly errors



Reduce costs and increase ROI with a solution that deploys quickly and can be integrated into existing infrastructure



Streamline deployment and management time with actionable data that surfaces changes in production quality within seconds

## Intel Components

- Intel® Xeon Processors
- Intel® Core™ Processors
- Intel® Distribution of OpenVINO™ toolkit
- Intel® Movidius™ VPUs

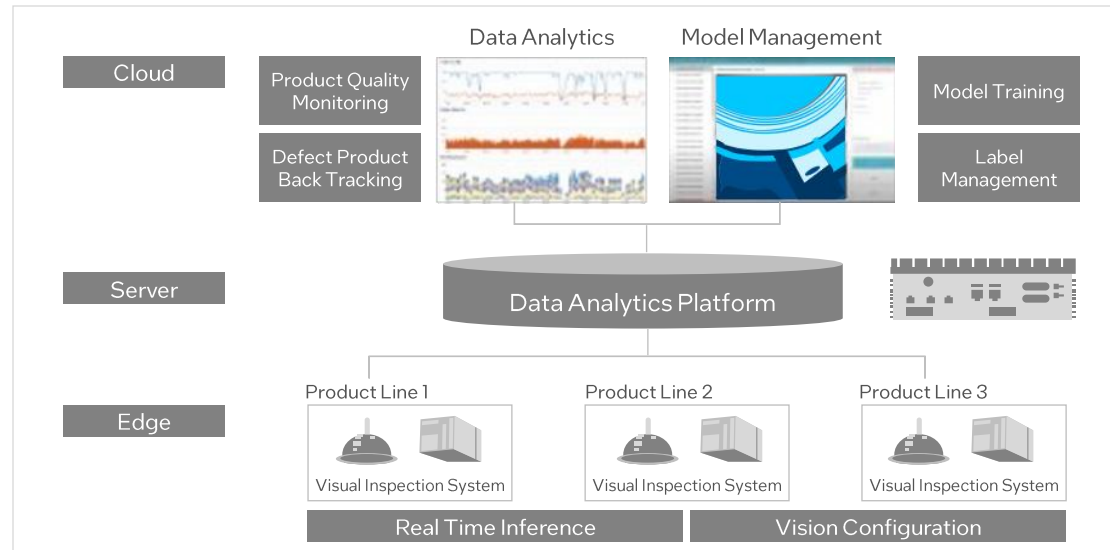

**Target Vertical:**  
Manufacturing

**Target Use Case:** Product Inspection

**Secondary Use Case:**  
Logistics & Tracking

## Geo Availability

Available in United States, PRC, Japan, Canada, Taiwan, Germany, and the UK

## Learn More

- [Vecow website](#)



### Solution Overview

In today's market, many offices, hotels, and buildings are searching for a contactless sterilization system. To address this demand, the Vecow VIK-UV Sterilization AMR was developed to provide a sterilization solution that is also capable of transporting up to 80kg of weight. With the solution's dynamic mapping system, the AMR can avoid non-static obstacles – such as humans and other AMRs, detect environmental boundaries, and operate in the dark by utilizing a combination of cameras, micro-sensors, and a LIDAR array. The VIK-UV AMR also comes with the VHub ROS, a SWARM enabled solution with AI and Robotic Control functions that accelerate AMR application and protocol development.

### Value Props

**Maintains healthy and safe working environments** by sterilizing over 21.6% of passed surface areas and automating tasks that facilitate strict exposure protocols

**Increases workplace efficiency** by automating delivery tasks and helping facility management teams focus on high priority tasks

**Reduces total cost of ownership** with flexible device rates, customer support, and an intuitive SDK interface that helps customers rapidly deploy their AMR fleet

### Intel Components

- Intel® Core™ Processors i5, i7, i9
- Intel® Xeon® Processors
- Intel® RealSense™ D435i
- Intel® Distribution of OpenVINO™ toolkit

Cloud	Sterilization	Goods Carriage	Fully Autonomous	Fleet management	Touchless Controls	Map Recording	Abnormal Alarm
Server	Data Analysis Platform		Real-time Positioning	Power Status	Speed		
Edge	VIK-UV	SPC-7100	Sensors Components	Lidar	DVC-1000 (Intel RealSense D435)	UV Light	Motor
				Wheel			

**Target Vertical:** Manufacturing

**Secondary Verticals:** Health and Life Sciences, Hospitality and Restaurants, Retail

**Target Use Case:** Logistics & Tracking

**Secondary Use Case:** Environmental Monitoring

**Geo Availability** Asia, Pacific, and Japan, Americas, Europe, Middle East and Africa, People's Republic of China

### Learn More

- Vecow - VHub ROS
- Product Demo - Video

## Solution Overview

VeeMed is a virtual care platform that addresses the needs of patients, providers, and healthcare systems at every stage of the patient journey and the entire continuum of care. VeeMed provides everything healthcare systems and remote physicians need to stand up and consolidate a world-class virtual care program.

## Value Props

- Increase patient access by removing geographic boundaries and increase revenue along with new markets
- Reduce clinician burnout by giving your team a fast, intuitive, and standardized platform
- Increase patient volume and decrease transfers and length of stay by augmenting on-site staff with a team of board-certified virtual specialists and physicians
- Drive efficiencies with optimized clinical protocols
- Eliminate your call center with VeeMed's integrated on-demand scheduling tools

## Intel Components

- Intel® NUC
- Intel® Core™ i5 processors
- Intel® Core™ i9 processors
- Intel vPro® Technology

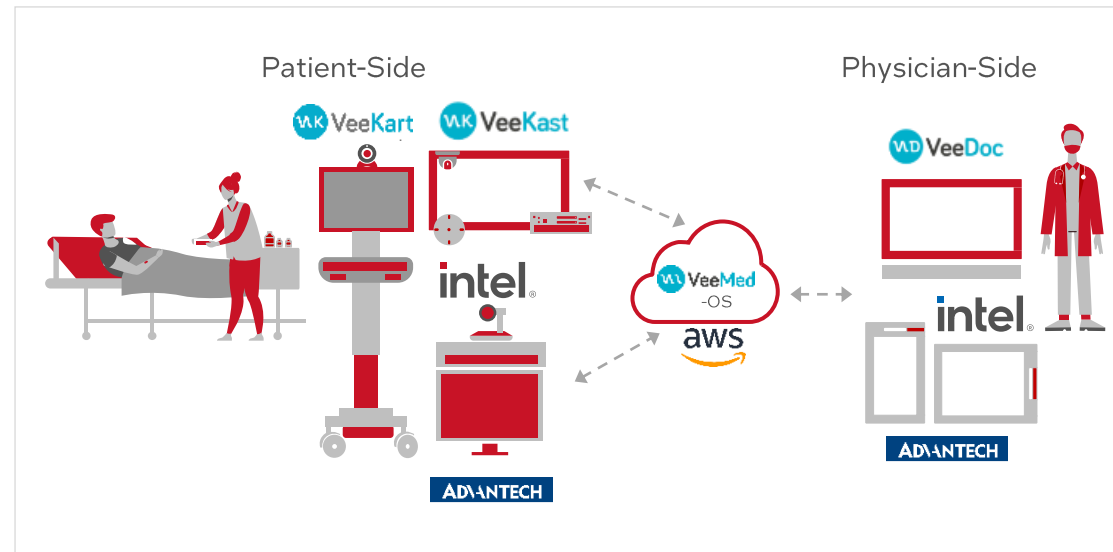

Target Vertical: Health and Life Sciences

Target Use Case: Human Wellness Monitoring

Geo Availability  
United States and EMEA

### Learn More

- [VeeMed Website \(VeeOne Health\)](#)



# Vehant Technologies TrafScan® Vehicle Detection System

## Solution Overview

As cities grow, they face increasing infrastructure challenges and congestion. Proper management is needed to maintain efficient traffic operations and to keep drivers and other road users safe. TrafScan® Vehicle Detection System by Vehant Technologies is a state-of-the-art, high-resolution vehicle detection camera system that uses artificial intelligence and machine learning-based vision algorithms. It is a non-intrusive system designed to provide vehicular flow information to urban traffic control systems. It enables the verification of vehicle presence, occupancy, count, and classification at traffic signals, as well as automatic incident detection, queue length calculation, and traffic density analysis, in order to help support traffic management.

## Value Props



Enhance traffic flow with advanced high resolution visual data analytics to support traffic monitoring and proactive traffic signal control.



Help improve road safety with real time vehicle and pedestrian detection and automatic and verifiable incident alerts to enable faster emergency response.



Optimize cost savings with a solution that is quick and easy to deploy and can be installed on existing infrastructure.

## Kit Components

- Intel® Distribution of OpenVINO™ toolkit
- Intel® Ethernet technology
- Intel® Core™ i5 processors

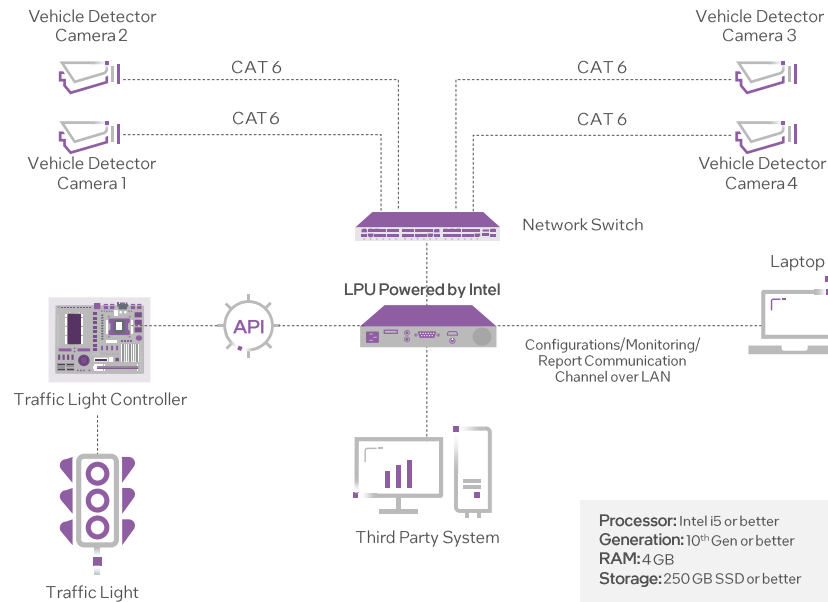

Processor: Intel i5 or better  
Generation: 10<sup>th</sup> Gen or better  
RAM: 4 GB  
Storage: 250 GB SSD or better

Target Vertical:  
Government

Secondary Vertical:  
Transportation

Target Use Case:  
Situational Monitoring

Geo Availability  
APJ

## Learn More

- [TrafScan® Solution Webpage](#)
- [News article highlight on Vehant Technologies](#)

# Drive-Thru Analytics Solution for Quick Service Restaurants (QSR)

## Solution Overview

Customers these days want quick and seamless checkout experiences with contactless payment. Restaurants want to meet these demands while also capturing insights from these actions. To meet this demand, V-Series developed the Drive-Thru Analytics Solution for Quick Service Restaurants, a total solution for fast checkout and drive-thru ordering that serves both business operators and customers. The solution collects customer data from various kiosks before sending to the cloud for further analysis. Key stakeholders can access these insights to empower decisions related to sales and operational efficiencies.

## Value Props



Enhance end customer experience with an intuitive digital interface that quickly and conveniently guides users through the purchasing process



Scale and allocate resource accordingly with reports that demonstrate trends related to ordering behavior to inform strategic business decisions



Reduce operational costs with dynamic kiosk displays that allow menus and promotional content to be updated remotely, mitigating the need for manual intervention

## Kit Components

- Intel® Core™ i5 Processors
- Intel® Distribution of OpenVINO™ toolkit
- Intel® Arc™ Graphics Drivers

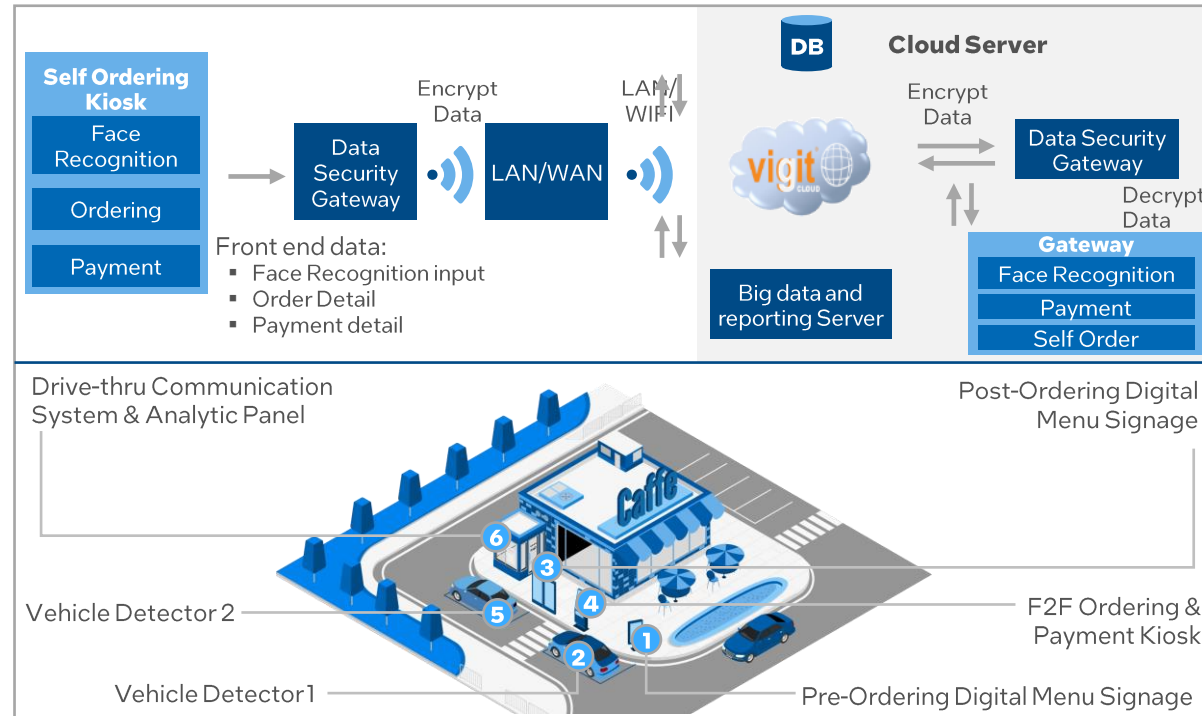

**Target Vertical:**  
Hospitality and Restaurants

**Secondary Vertical:**  
Retail

**Target Use Case:**  
Situational Monitoring

**Geo Availability**  
APJ

## Learn More

- [V-Series Website](#)
- [V-Series Drive-Thru Solution](#)



## V-Sync SmartVendor

### Solution Overview

A state-of-the-art digital signage vending machine equipped with a large LCD, LTE, face recognition, AI and more. V-Sync SmartVendor provides many additional functions from distributing refreshing beverages or hot food to disseminating disaster information.

### Value Props

- Maximize revenue with a multifunctional solution
- Minimize opportunity loss with an autonomous maintenance system
- Engage more customers as the solution serve as an interactive information board, take customer photos, and more

### Intel Components

Intel® Core™ i7 vPro

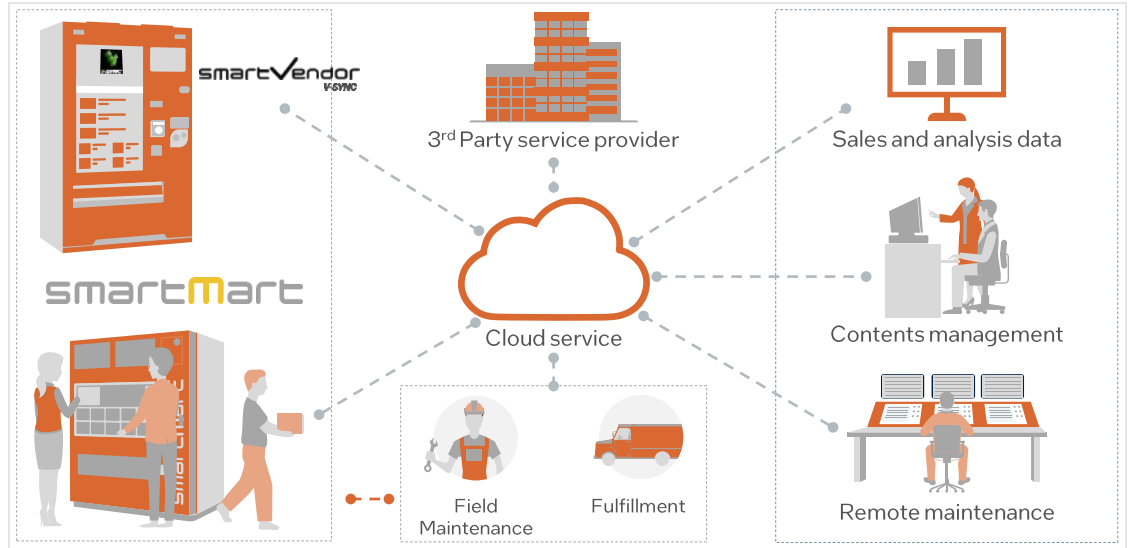

**Target Vertical:** Retail

**Secondary Verticals:** Government

**Target Use Case:** Asset & Operations Optimization

**Geo Availability**  
Japan

### Learn More

- [The V-Sync Official Website](#)



# Vesystem Cloud Terminal Healthcare Solution

## Solution Overview

An end-to-end cloud desktop solution from Vesystem integrates VDI, VOI, and IDV to achieve front-end and back-end hybridization. Organizations can use the solution to enhance management, security, operation, and maintenance of their large-scale terminals, enabling hospitals to upgrade their IT processes

## Value Props



Increase operational efficiency with centralized deployment, maintenance, management, and security of virtual desktops



Help improve data security by integration of medical resources into a single cloud management platform for more effective control and share



Enjoy rapid deployment with a highly compatible solution that does not require changes to original network structure or business applications

## Intel Components

- Intel® Celeron® Processors
- Intel® Core™ i3 Processors
- Intel® Core™ i5 Processors

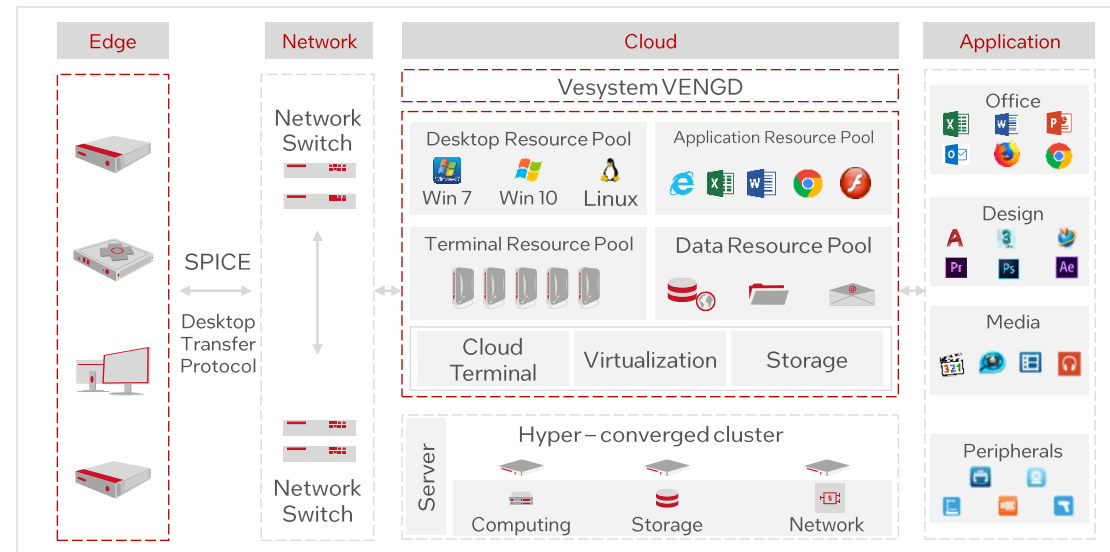

Target Vertical: Health & Life Sciences

Target Use Case: Asset & Operations Optimization

Geo Availability  
PRC

Learn More

- [Vesystem Website](#)



# Videonetics Intelligent Video Management Software

## Solution Overview

A hierarchical, distributed, and modular enterprise-class video management solution capable of serving diverse use cases with multi-site support. Features fully integrated video management tools to transform raw video data into actionable insights.

## Value Props



Streamline video management with simple and intuitive GUI



Leverage AI deep learning with integrated object classification and identification



Scale across multiple verticals with unified, monolithic system architecture

## Intel Components

- Intel® Xeon® processor
- Intel® Core™ i7 processor
- Master, database, media, video analytics, event aggregation, API, and third-party integration API servers
- IoT gateway/edge processor
- Workstations

Top-level intelligent VMS systems architecture diagram

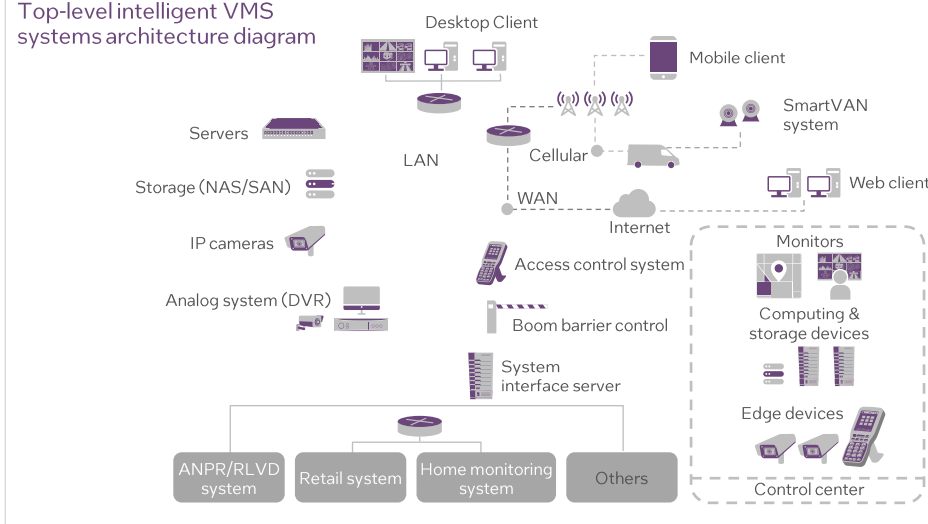

**Target Vertical:**  
Transportation

**Secondary Verticals:** Retail, Banking/Financial Services, Hospitality, Education, Health & Life Sciences

**Target Use Case:**  
Situational Monitoring  
**Secondary Use Cases:**  
Asset & Operations Management, Product Inspection

**Geo Availability**  
Available in SE Asia, Europe, US, UK, Middle East and Africa

- Learn More**
- Videonetics Resources
- [Videonetics Intelligent VMS Webpage](#)
- Intel Resources
- [Videonetics Intel® Solutions Marketplace](#)



# ViewSonic ViewBoard

## Solution Overview

An Interactive Flat Panel (IFP) that provides a scalable and adaptable digital collaboration and whiteboarding experience

## Value Props



Promote collaboration by allowing users to connect and interact with meeting content in real time, from any location



Foster creativity using interactive software to draw on-screen for more engaging presentations



Improve productivity with wireless screen sharing, rapid access to content, and customizable settings

## Intel Components

- Intel Unite® software
- Intel® Core™ i7 vPro™
- Intel® Core™ i5 vPro™
- Intel Wi-Fi Module

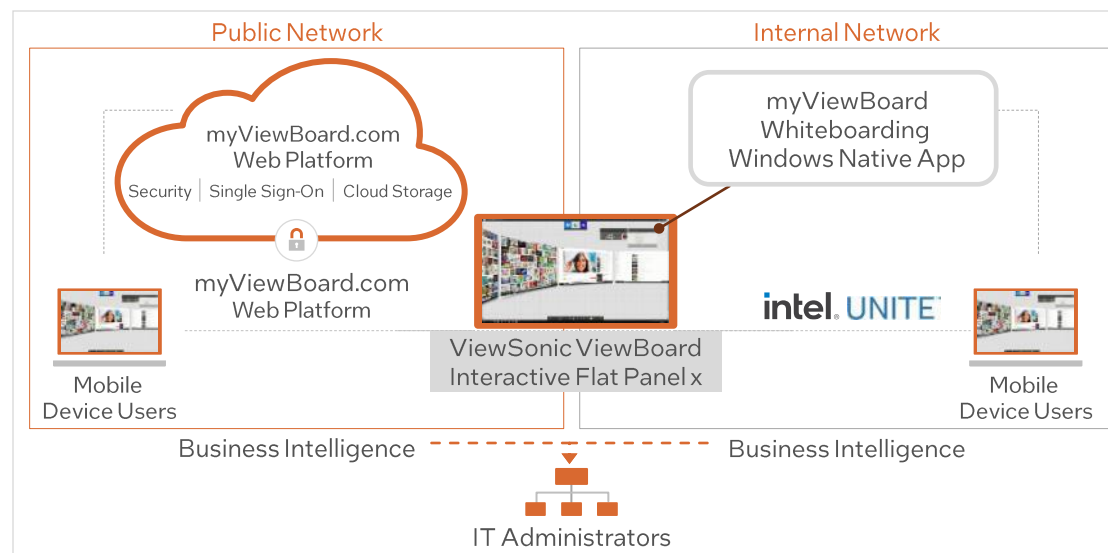

**Target Vertical:** Retail

**Secondary Vertical:** Education

**Target Use Case:** Interactive Media

## Geo Availability

Available in the Americas, APAC, Australia/New Zealand, and EMEA

## Learn More

- ViewSonic and Intel collaboration on [Business Insider](#)
- ViewSonic ViewBoard [demo video](#) and [training video](#)
- ViewSonic Viewboard [compass](#)
- Intel® [Solutions Marketplace](#)

# ViewSonic Wireless Collaboration Display

## Solution Overview

Wireless Collaboration Display is a high-quality video conferencing solution that provides next-generation tools to help spark creativity and drive productivity. Equipped with a premium conference camera, microphone array, 4K touchscreen, and an Azure IoT sensor, ViewSonic delivers the cutting-edge technology organizations need to digitally transform the workplace, increase meeting efficiency, and drive ideas forward.

## Value Props

- Connect seamlessly with instant plug-and-play, wireless, and browser-based connection capabilities that help users quickly and easily display content
- Optimize collaboration with cutting-edge audio and video technology, a high-resolution display, and a natural writing experience
- Simplify setup with user-friendly installation, out-of-the-box functionality, and integrated management and maintenance systems

## Intel Components

- Intel® Core™ i7 Processors
- Intel® Core™ i5 Processors
- Intel vPro® Platform

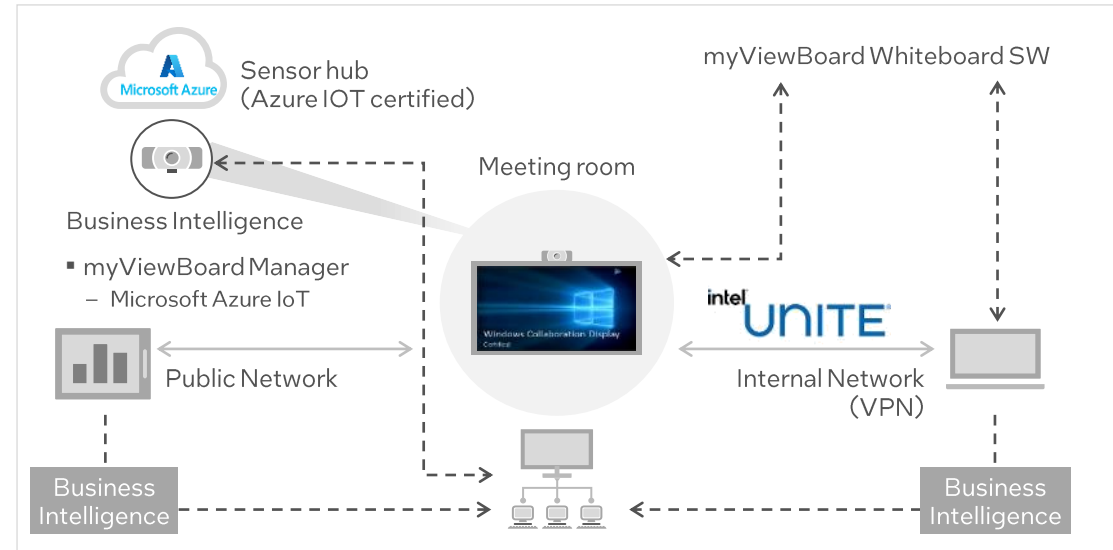

**Target Vertical:** Other

**Secondary Verticals:** Banking & Financial Services, Education, Government

**Target Use Case:** Interactive Media

**Secondary Use Cases:** Asset & Operations, Optimization, Environment Monitoring

### Geo Availability

North America, Australia, New Zealand, India, Taiwan, Germany, Israel, Middle East, North Africa and Turkey, Russia, and the United Kingdom

### Learn More

- [ViewBoard® IFP70 Webpage](#)
- [Deloitte Uruguay Modernizes Boardrooms Case Study](#)

# VisionLabs LUNA PLATFORM

## Solution Overview

The VisionLabs LUNA PLATFORM solution is a privacy-oriented facial recognition solution designed to help customers in the banking, financial services, retail, transportation industries, and beyond with biometric data management and security.

## Value Props



**Increase revenues** by generating more remote customer engagements through a system that offers both a high level of mobile accessibility and security



**Streamline customers' experience** by leveraging biometric tools to expedite registration and user login, user identification, and other services



**Enhance security** by using facial recognition and human reidentification technologies to help protect customers and employees across range of verticals

## Kit Components

- Intel® RealSense™ Technology
- Intel® Core™ i3, i5, i7 Processors
- Intel® Xeon® Processors

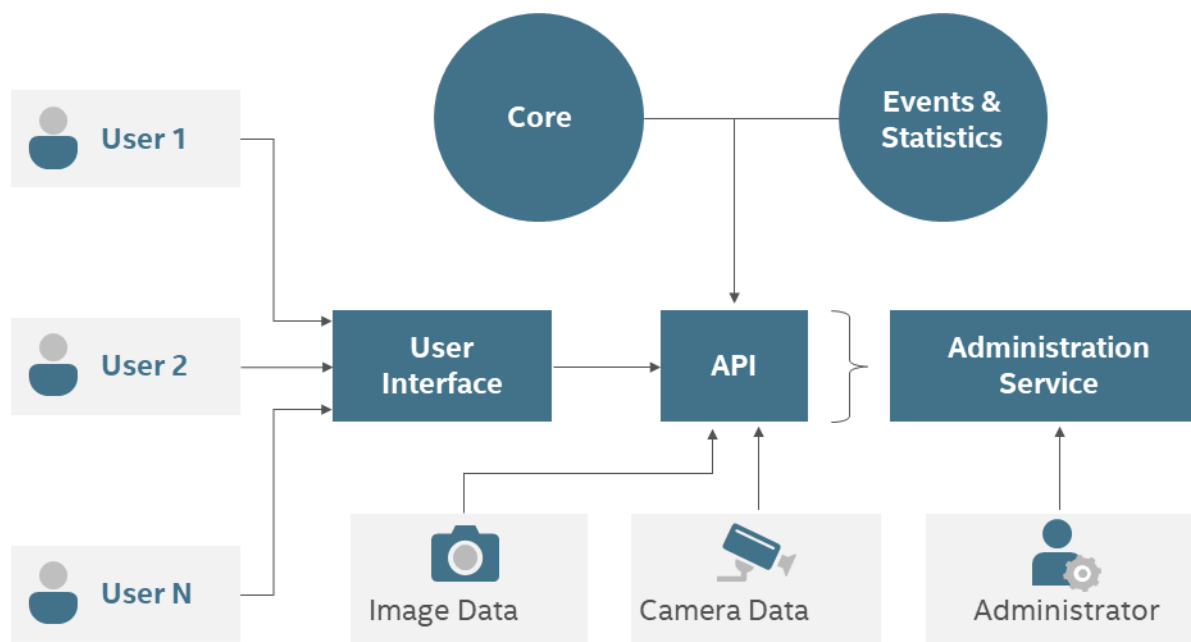

**Target Vertical:**  
[Banking/FSI](#)

**Secondary Vertical:**  
[Health & Life Sciences;](#)  
[Retail; Transportation](#)

**Target Use Case:**  
[Situational Monitoring](#)

**Secondary Use Case:**  
[Human Wellness](#)  
[Monitoring; Logistics & Tracking](#)

**Geo Availability**  
United States; ANZ; India;  
Germany; Russia; Middle East; APJ; South America

## Learn More

- [LUNA PLATFORM Webpage](#)
- [VisionLabs Website](#)

# Wachter Healthcare NOVA

## Solution Overview

An open architecture solution that gives hospitals a complete virtual window into their patients' conditions and statuses. NOVA is easily implemented and scaled to any healthcare system for optimal patient care.

## Value Props

- Promote staff efficiency with virtual patient monitoring that enables staff to focus on their core clinical responsibilities
- Provide a safe patient environment with predictive alarms and fast and accurate patient data analysis
- Improve staff productivity with centralized communication and reporting tools that enable collaboration

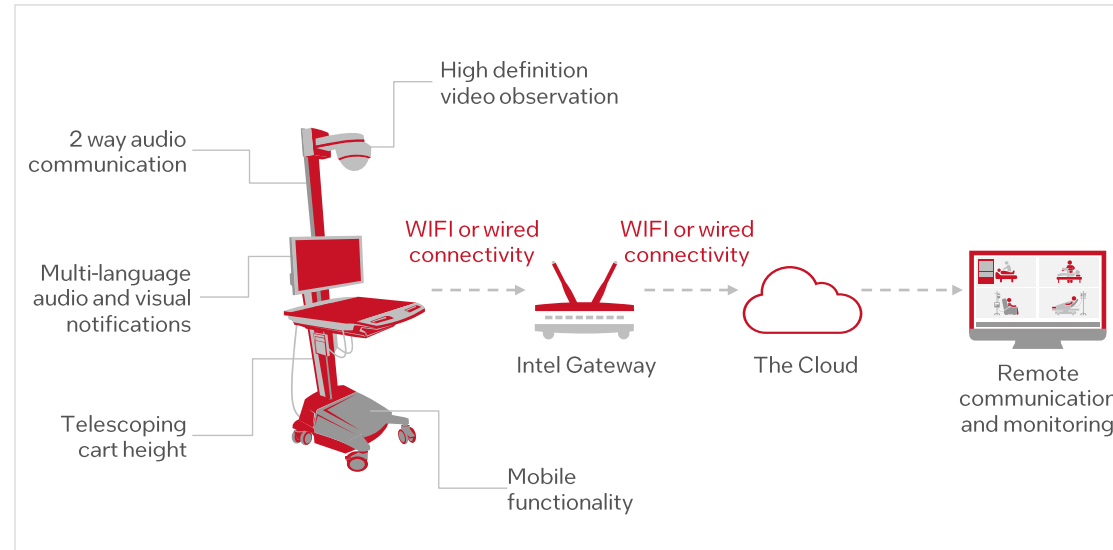

## Intel Components

- Intel® Data Center, Intel® Xeon® Servers
- Intel® Rugged IoT Gateways
- Intel® Workstations, Intel® Core™ i5/i7 Server
- Intel Atom® IoT Gateways

**Target Vertical:** [Health & Life Sciences](#)  
**Secondary Verticals:** [Government](#)

**Target Use Case:** [Human Wellness Monitoring](#)  
**Secondary Use Cases:** [Interactive Media](#), [Situational Monitoring](#)

**Geo Availability**  
 Currently only available directly from Wachter in the United States with other geos pending. Contact [Patricia Palmietto](#) for ordering information.

**Learn More**  
 ▪ [Wachter's healthcare solutions website](#)

# WiCis Health 3.0



## Solution Overview

WiCis Health 3.0 Telehealth Beyond Video is a video-integrated telehealth screening system that works on any Internet connected device. By using automated messaging, real-time analytics, flexible billing, and remote monitoring, the WiCis Health 3.0 Telehealth Beyond Video system delivers a platform through which providers can manage careflows.

## Value Props

- Optimize communications** with a file sharing platform that supports MRI scans, doctors' notes, patient pictures, and more
- Augment institutional healthcare** by centralizing care flows across multiple providers and patients
- Generate new revenue streams for caregivers** by providing new verticals and services
- Access underserved patients** with an easy-to-use telehealth system

## Intel Components

- Intel® Core™ i5 Processors
- Intel® Core™ i7 Processors
- Intel® RealSense™ Technology

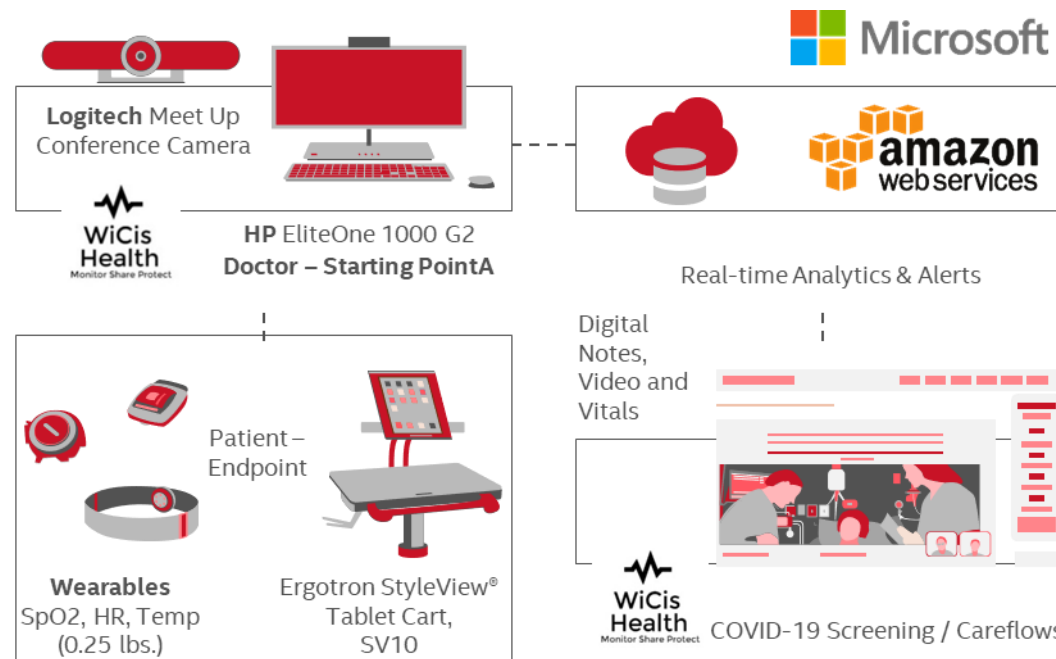

**Target Vertical:**  
[Health & Life Sciences](#)

**Secondary Verticals:**  
[Hospitality](#), [Education](#)

**Target Use Case:**  
[Human Wellness Monitoring](#)

**Secondary Use Case:**  
[Situational Monitoring](#)

**Geo Availability**  
United States,  
Australia/New Zealand,  
India, and EMEA

### Learn More

- [WiCis Health 3.0 Solutions](#)
- [WiCis Health Features](#)
- [Home - WiCis Health](#)



# Widya Robotics Intelligent Gate

## Solution Overview

The Widya Robotics Intelligent Gate harnesses the power of cutting-edge AI and reliable Intel® architecture to provide organizations with an integrated turnstile barrier that automatically provides employee identification, scans for the use of Personal Protective Equipment (PPE), and checks body temperature. In just moments, the Widya Robotics Intelligent Gate can identify and verify individuals for fast and secure location access.

## Value Props



**Help enhance security** with a solution that utilizes AI technology for biometric identification to ensure only approved individuals gain entrance.



**Streamline workflow** with a solution that makes employee identification verification fast and simple through biometric identification.



**Reduce costs** with a solution that fully automates entrance identification and avoid the need for manual verification.

## Intel Components

- Intel® NUC
- Intel® Distribution of OpenVINO™ toolkit

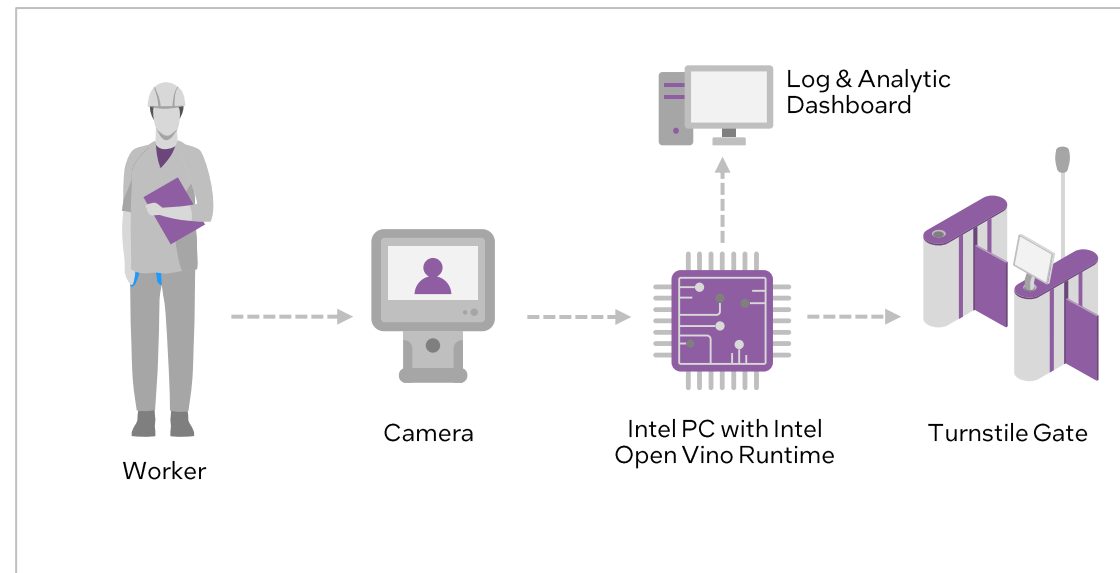

**Target Vertical:**  
Government

**Secondary Vertical:**  
Education, Energy, Health and Life Sciences, Hospitality, Retail, Manufacturing, Transportation, Banking/Financial Services

**Target Use Case:**  
Control Optimization & Autonomy

**Geo Availability**  
Asia, Pacific, and Japan

### Learn More

- [Widya Robotics Website](#)
- [Intelligent Gate Webpage](#)
- [Intelligent Gate Video Profile](#)



# Wincomm Corporation Smart EMR Solution for e-Healthcare

## Solution Overview

A series of high-powered medical display panels that enables healthcare providers' preexisting EMR Software. By connecting healthcare facilities with high-res, versatile panels and monitors, hospitals are able to stay connected and easily share important data.

## Value Props



Connect healthcare facilities with flexible implementation across various locations



Increase Patient Safety with anti-bacterial device housing



Ensure consistent operability through a collection of failsafe features and additional ports for flexible expansion

## Intel Components

- Intel® Core® i5-7200U
- Intel® Core® i5-6200U
- Intel® Core® i7-7700T

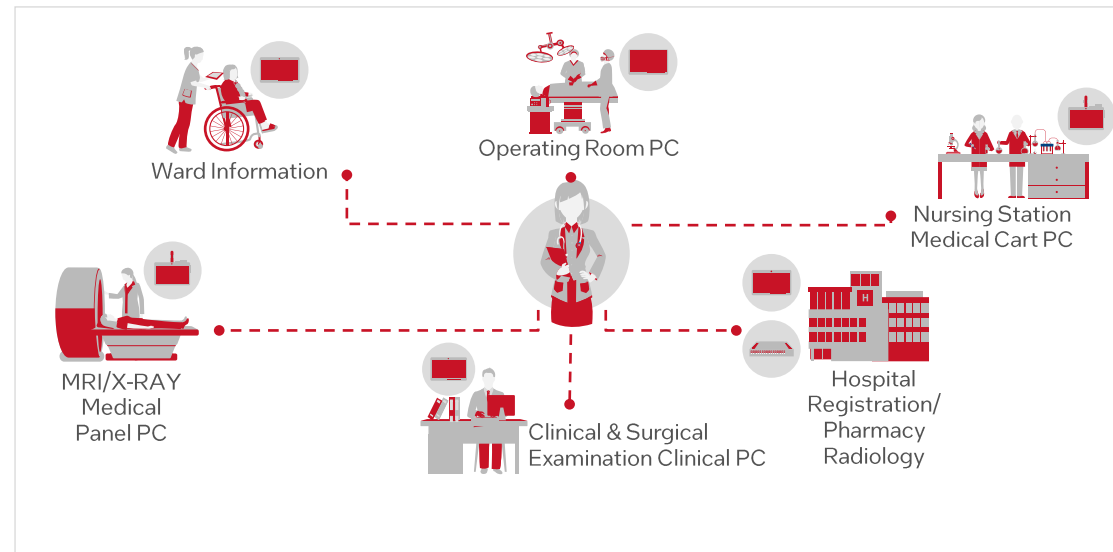

Target Vertical: Health & Life Sciences

Secondary Verticals: Government

Target Use Case: Asset & Operations Optimization

Geo Availability  
US, EU, APAC, Japan

Learn More  
The Wincomm Corporation Smart EMR Solution for e-Healthcare website [here](#)





# Wincomm Corporation Smart Hygiene Control Solutions

## Solution Overview

Wincomm's Smart Hygiene Control Solutions incorporates high-processing power with IPDD/69K Panel PCs. First, it collects and analyzes image data from industry setting processes, such as images of pills, food, mouth covers, and even behaviors. Then, from the data analysis, the system is optimized via machine learning.

## Value Props

-  Help maintain a sanitary workplace with hardware that incorporates advanced tech for sanitary purposes
-  Provide high-adaptability to keep up with fast-moving industry pacing, from the manufacturing setting, to food processing plants, and medical centers
-  Monitor industry processes easily with high-powered systems to streamline processes

## Intel Components

- Intel® Core™ i5-6500
- Intel Atom® Processors
- Intel® Celeron® Processors
- Intel® Core™ i5 and i7 Processors
- Intel® Distribution of OpenVINO™ toolkit
- Intel® Vision Accelerator Design with Intel®
- Movidius™ Myriad™ X Visual Processing Unit
- Intel® Ethernet Controller I210-AT
- Intel® Ethernet Connection I219-LM

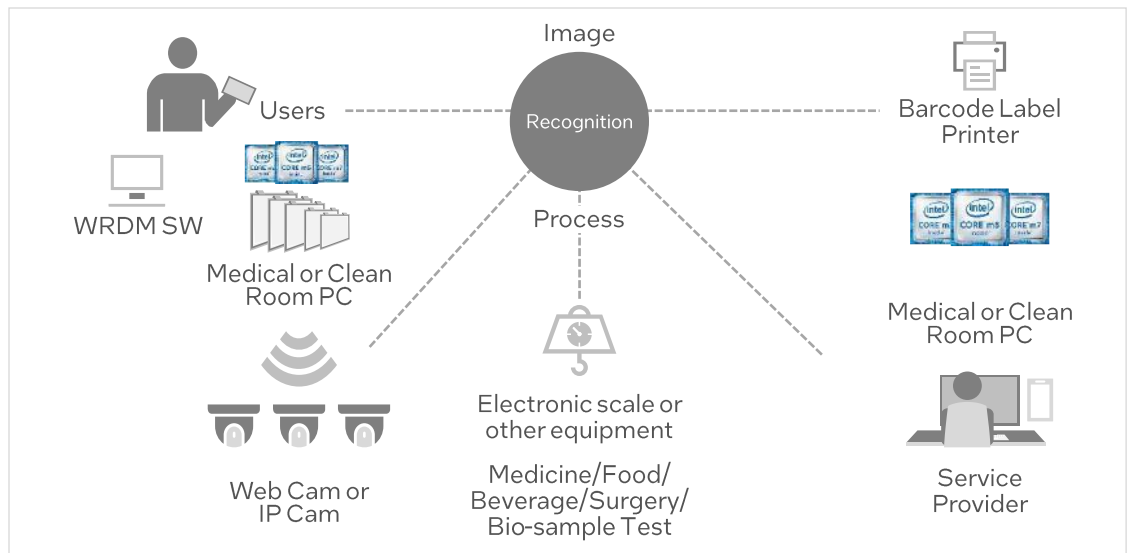

Target Vertical:  
Manufacturing

Target Use Case:  
Situational Monitoring

Secondary Use Case:  
Asset and Operations Optimization

## Learn More

- Application Story
- Intel® Solutions Marketplace
- Stainless Steel Panel PCs' Data Sheets



# Winmore Digit-China Barcodeless Goods Identification Kit

## Solution Overview

Most customers are no stranger to long checkout lines at the grocery store. Queues are even longer when employees are required to memorize and manually input lengthy product codes for barcodeless items such as bulk dry goods or fresh produce (e.g., fruits, vegetables, dry food, seafood, bulk snacks, and bakery products). Manual checkout tasks can be time-consuming, costly, and inaccurate increasing the demand for automated solutions that help improve customer service, boost employee morale, and reduce labor costs. The Winmore Digit-China Winmore Barcodeless Goods Identification Kit leverages artificial intelligence to automatically identify products at checkout terminals, with or without barcodes, to help streamline transaction processes.

## Value Props



Improve customer experiences by reducing transaction time and shortening customer queues with an automated product identification, weighing, and pricing solution



Streamline operations and increase efficiency by decreasing the need for staff intervention with an easy-to-use smart interface that self-trains to increase customer throughput



Reduce operational costs through AI visual inspection that helps optimize staff allocation, and decreases the need for staff training

## Kit Components

- Intel® Distribution of OpenVINO™ Toolkit
- Intel® Atom® Processors
- Intel® Core™ i3 Processors
- Intel® Xeon® Processors
- Intel® Server GPU

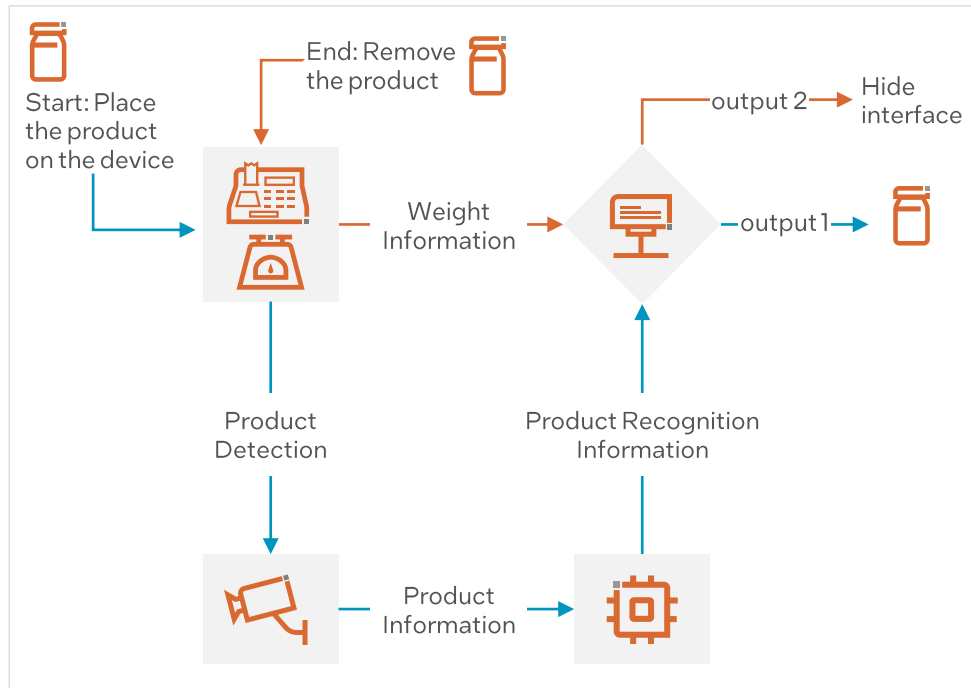

Target Vertical: Retail

Secondary Vertical: Agriculture, Health and Life Sciences, Hospitality and Restaurants

Target Use Case: Asset and Operations Optimization

Geo Availability: APJ, Americas, Europe, Middle East, Africa, and PRC

Learn More

- Winmore Digit Home



# QINGDAO Wintec Self-Checkout Solution Enabled with Loss Prevention

## Solution Overview

The Wintec Self-Checkout Solution Enabled with Loss Prevention leverages edge-to-cloud connectivity to provide a seamless and secure customer experience. It begins at the edge, where customers interact with the self-checkout kiosk. At the edge, video camera feeds capture data that is processed in real-time using AI behavior recognition, to swiftly detect abnormal patterns that could indicate potential theft. If unusual behavior is detected, the POS alert light turns red, prompting employees to monitor the transaction. After the transaction is completed, data is encrypted and transmitted to the cloud for further processing. In the cloud, this data is analyzed to refine loss prevention and AI behavior algorithms to enhance their accuracy and effectiveness over time.

## Value Props



**Improve profitability through advanced loss prevention** using a solution that detects shoplifting, identifies potentially fraudulent activities, and predicts possible theft patterns to protect your inventory and reduce shrinkage.



**Boost customer satisfaction** with a user-friendly solution that simplifies the checkout process for shoppers to increase transaction efficiency, minimize wait times, and elevate the customer experience.



**Empower strategic business decisions** with real-time data analysis that offers valuable insight into customer shopping patterns and preferences to help inform strategic decisions that drive sales.

## Intel Components

- Intel® Core™ i3 processors
- Intel® Core™ i5 processors
- Intel® Distribution of OpenVINO™ toolkit

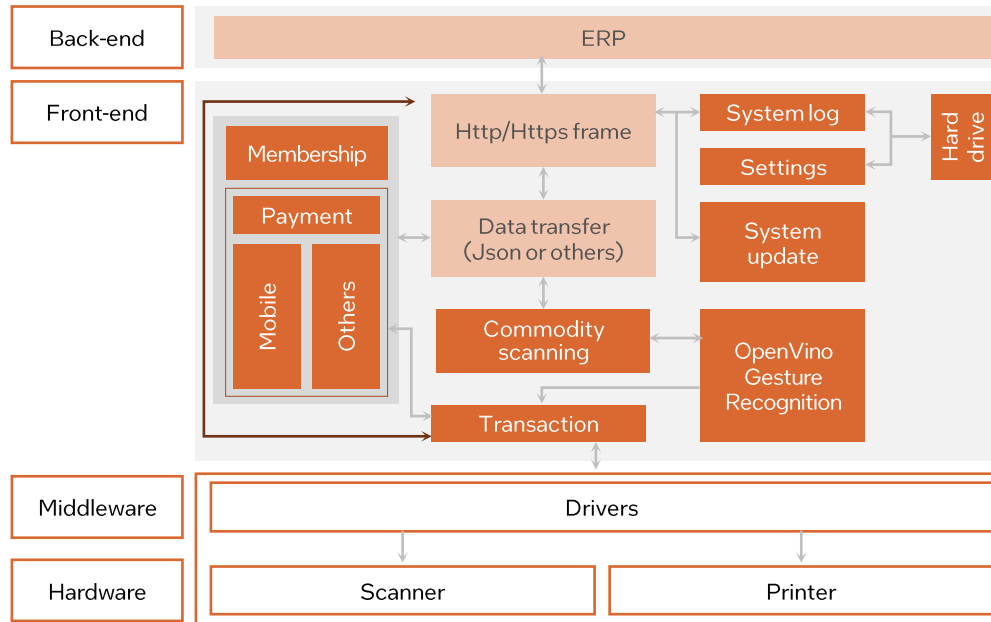

Target Vertical: Retail

Secondary Vertical: Hospitality and Restaurants

Target Use Case: Asset & Operations Optimization

Secondary Use Case: Interactive Media, Logistics & Tracking

Geo Availability

Americas, APJ, EMEA, PRC

Sales Contact

Shang Li - [lishang@wintec.cn](mailto:lishang@wintec.cn)

Solution Webpage

[WINTEC Solution Webpage](#)

Learn More

[WINTEC SelfPOS60](#)



[Back to Other Solutions](#)

[Back to Asset & Operations Optimization Use Cases](#)



# Wipro Limited Digital Twin for Smart Buildings

## Solution Overview

Property costs represent the second highest expense for an organization due to high operational and maintenance requirements. For businesses to increase their efficiency and optimize across their enterprise, it has become increasingly vital to leverage technology to manage property assets. Wipro's Digital Twin for Smart Buildings provides a foundation for a business' entire smart building environment. It brings together IT and OT systems, IoT sensors, and third-party data and contextualizes this with information about processes and people, creating a dynamic digital replica that can be used to solve a wide variety of issues. The solution supports multiple workflows and helps realize data analytics, enabling businesses to streamline operations.

## Value Props



**Reduce operational costs** with an end-to-end solution that helps lower workforce workloads and building maintenance costs



**Streamline building management systems** with a unification system designed to navigate multiple siloed systems across an enterprise



**Increase user satisfaction** with an interface that provides single pane view of buildings, adjustable based on user preferences



**Move towards sustainability** with real-time, auditable, system-driven carbon, footprint, waste, water, and environment data

## Proven Results

- **The situation:** A leading construction and Facilities Management Solution (FMS) player of Europe was managing multiple buildings using various siloed tools, which led to high operational costs and lack of remote visibility for smooth facility services.
- **The solution:** Wipro deployed its solution to unify the systems and provide a digital twin view of buildings to enable remote facility monitoring and control, which also generated real time descriptive analytics for KPI monitoring through a digital twin model.
- **The results:** With the help of Wipro's solution, the customer was able to improve operational excellence, higher business performance, better user experience and enhance sustainability monitoring.

## Intel Components

- Intel® Core™ i7 Processors
- Intel® Core™ i5 Processors
- Intel® Xeon® Scalable Processors
- Intel® Distribution of OpenVINO™ toolkit

**Target Vertical:** [Other](#)  
**Secondary Verticals:** [Energy](#), [Retail](#), [Education](#), [Health and Life Sciences](#), [Hospitality and Restaurants](#), [Government](#), [Manufacturing](#), [Transportation and Warehousing](#)

**Target Use Case:** [Asset & Operations Optimization](#)  
**Secondary Use Cases:** [Situational Monitoring](#), [Environment Monitoring](#), [Energy Monitoring and Management](#), [Control Optimization & Autonomy](#), [Interactive Media](#), [Machine Condition Monitoring](#), [Human Wellness Monitoring](#)

**Geo Availability:** Global

### Learn More

- [Wipro Website](#)
- [Wipro and Intel in Smart Buildings](#)
- [Wipro Digital Twin Article](#)



Back to Other Solutions

Back to Asset & Operations Optimization Use Cases



# Wipro Limited Edge Device Management for OT and IoT

## Solution Overview

There has been a multi-fold increase in enterprise dependency on physical assets –business critical and support infrastructure alike. To stay competitive, enterprises need to effectively monitor, manage and control physical devices, edge gateways, processes and events. Edge computing architecture can mitigate latency and downtime issues for IoT use cases, but the IoT device landscape is complicated and often hard to manage. Wipro’s Edge Device Management for OT and IoT empowers its clients to revolutionize their operating models and innovate with a platform that allows them to manage OT systems in tandem with the entire IoT device lifecycle, providing tools for connecting, provisioning, monitoring, managing, configuring, controlling, and evolving a fleet that has widely different devices operated by a huge enterprise. With the Wipro solution, enterprises can stay ahead of the curve.

## Value Props

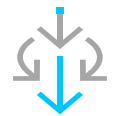

**Streamline operations** by leveraging service automation, support services, and customized workflows all through one centralized platform



**Drive cost savings** by eliminating unnecessary hardware and software and reducing capital and operating expenses



**Facilitate decision making** with real-time OT and IoT system performance insights, enabling proactive and informed system management

## Kit Components

- Intel® Core™ i7 processors
- Intel® Xeon® processors

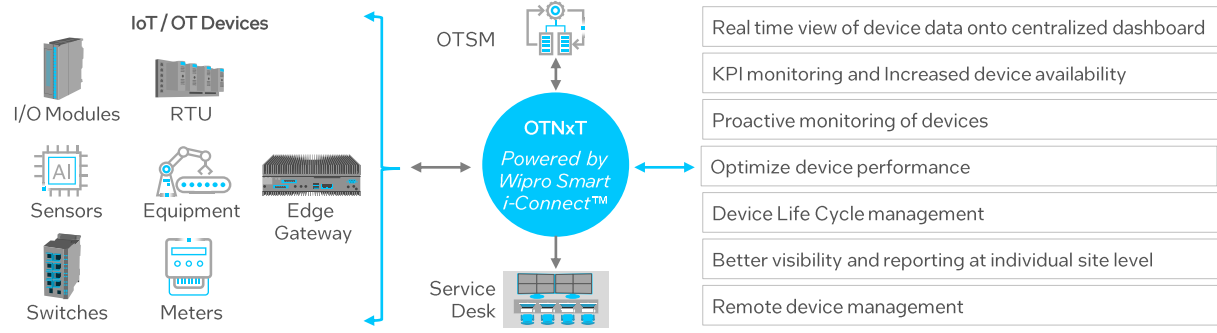

**Target Vertical:**  
Other  
**Secondary Vertical:**  
Retail, Education, Energy, Government, Health and Life Sciences, Hospitality and Restaurants, Manufacturing, Transportation and Warehousing

**Target Use Case:**  
Asset & Operations Optimization  
**Secondary Use Case:**  
Control Optimization & Autonomy

**Geo Availability**  
 APJ, Americas, EMEA

**Learn More**

- [Solution Webpage](#)
- [Wipro Website](#)



# Wipro Limited Smart i-Building

[Back to Other Solutions](#)

[Back to Asset & Operations Optimization](#)



## Solution Overview

Wipro's Smart i-Building solution offers a modular and efficient approach to support smart building use cases, provide facilities management, and promote sustainability. It addresses key business tenants such as operational cost, employee experience, operational excellence, and more. The solution leverages a Building IoT, AI, and automation technology as a key driver for efficiency and to enable a suite of smart building use cases across different industries. It provides a powerful and user-friendly platform for centralized monitoring and management for HVAC, lighting, access control, and network infrastructure and equips customers with intelligence-driven insights to drive operational improvements and digital transformation.

## Value Props



**Streamline operations** with actionable insights to optimize building resources, thus reducing costs



**Enhance user experience** with simple, intuitive, and personalized interfaces to interact with building data and systems



**Improve business performance** by leveraging AI to streamline resource management and processes



**Enhance sustainability** with real-time, auditable, system-driven carbon footprint, waste, water, and environment data

## Proven Results

- **The situation:** A leading facilities management solution (FMS) company with siloed systems, limited automation, high operational costs due to reactive management, and no singular operational view for facilities management.
- **The solution:** Wipro offered the Smart i-Building solution to manage multiple buildings from their Operation center and have real-time / near real-time data of assets, sensors and integrated devices to report on resource usage. The edge IoT-based integration provided real-time descriptive analytics for KPI monitoring
- **The results:** By implementing the Smart i-Building solution, the customer could realize facilities management costs by over 15%, reduced overall operational costs by over 10%, and created new revenue streams to expand offers to clients.

1. Intel® MRS Assessment

## Intel Components

- Intel® Core™ i7 processors
- Intel® Core™ i5 processors
- Intel® Xeon® Scalable processors
- Intel® Distribution of OpenVINO™ toolkit

**Target Vertical:** Other  
**Secondary Verticals:** Retail, Education, Energy, Government, Health and Life Sciences, Hospitality and Restaurants, Manufacturing, Transportation and Warehousing

**Target Use Case:** Asset & Operations Optimization

**Secondary Use Cases:** Interactive Media, Machine Condition Monitoring, Human Wellness Monitoring, Situational Monitoring, Environment Monitoring, Energy Monitoring and Management, Control Optimization & Autonomy

**Geo Availability:** Global

### Learn More

- [Wipro Website](#)
- [Wipro and Intel in Smart Buildings](#)
- [Wipro Smart Buildings Article](#)



# Wobot Hygiene and Safety Module

## Solution Overview

Wobot's Hygiene and Safety Module uses AI-powered video analytics to monitor a wide range of processes and screen for regulatory compliance, adherence to standard operating procedures, and hygiene and safety protocol. The solution provides rapid analysis through edge processing to help business leaders drive safety, efficiency, and situational awareness.

## Value Props



Enhance safety and process compliance with video analytics capabilities to help protect customers and workers



Streamline integration with a do-it-yourself onboarding tool to help minimize deployment costs and setup time



Enhance incident management with real-time insights and alerts that provide each user with relevant information

## Intel Components

- Intel® Core™, Intel® Xeon®, and Intel® Pentium® processors
- Intel® Math Kernel Library (Intel® MKL)
- Intel® Movidius™ Myriad™ VPU
- Intel® Distribution for Python\*
- Intel® MKL-DNN
- Intel® Movidius™ Neural Compute SDK
- Intel® Distribution of OpenVINO™ Toolkit

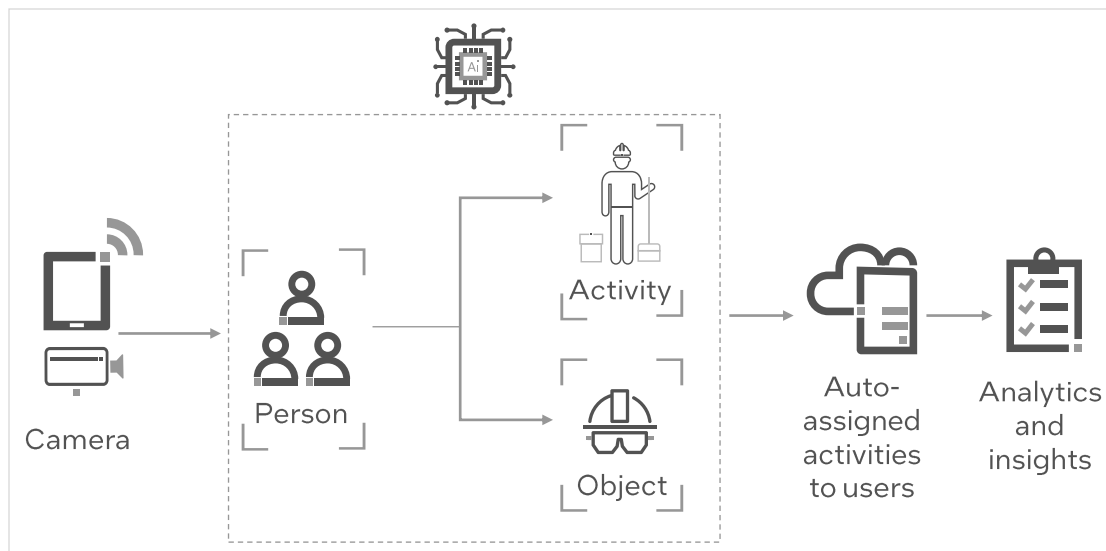

**Target Vertical:**  
[Manufacturing](#)

**Secondary Verticals:**  
[Health & Life Sciences](#),  
[Hospitality](#), [Government](#),  
[Retail](#), [Transportation](#),  
[Smart City](#), [Industrial](#)

**Target Use Case:**  
[Situational Monitoring](#)

## Geo Availability

Available in APJ, EMEA, Americas, and PRC

## Learn More

- [Wobot Website](#)
- [Case Study](#)
- [Wobot Case Studies](#)

# WolfVision Cynap Pure

## Solution Overview

WolfVision Cynap Pure transforms meeting rooms and classrooms into wireless BYOD presentation and collaboration environments in education and corporate settings. It supports a variety of devices and operating systems without requiring the use of apps, additional software, or plug-in dongles.

## Value Props



Enhance network security across all your data and devices that are connected to the WPS



Provide consistent learning experiences for students both in-classroom and learning remotely



Save time and cost efficiencies with free firmware updates and product improvements

## Intel Components

Intel® NUC

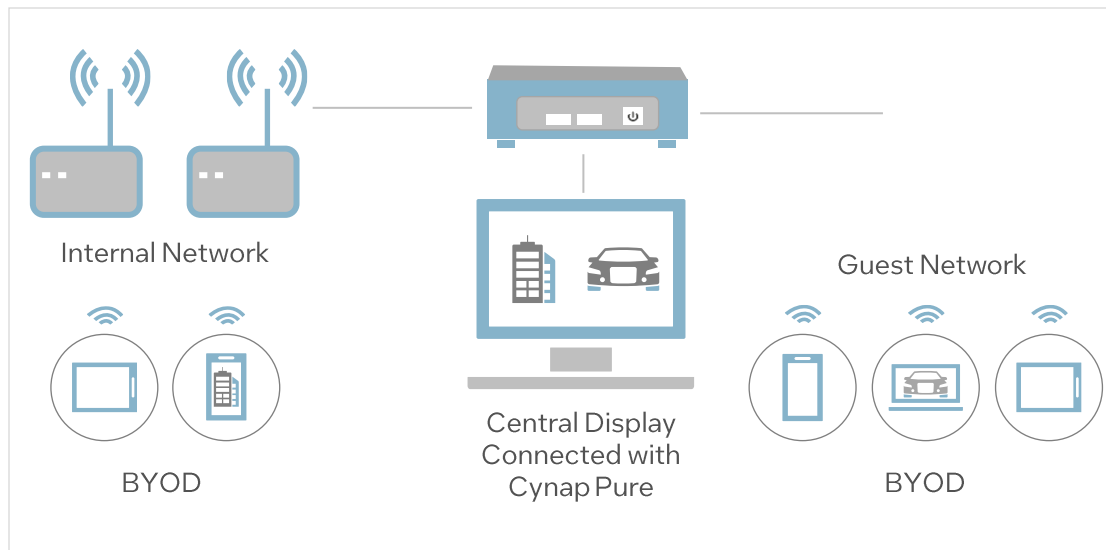

Target Vertical: Education

Secondary Vertical: Corporate

Target Use Case: Interactive Media

Secondary Use Cases: Wireless Presentation, Remote/Hybrid Meetings, In-person, Online, or Hybrid Classrooms

Geo Availability Globally

Learn More

- [Product page](#)
- [Company website](#)

# SMT Intelligent Smart Storage Rack Solution

## Solution Overview

The SMT Intelligent Smart Storage Rack Solution enables efficient control and monitoring of the entire warehouse business and cost management process, ensuring seamless management of enterprise warehouse information. The system can help clients perform a wide range of warehousing operations and, when integrated with other system documents and vouchers, provides comprehensive analytics on enterprise business processes, from shipping and receiving to financial management information.

## Value Props



Optimizes warehouse management by helping businesses achieve effective control and tracking of their products and goods by improving inventory accuracy and space utilization



Enables businesses to make informed decisions by providing comprehensive operations, inventory, and financial information, empowering organizations to make the best market and data-driven decisions



Helps improve overall supply chain logistics with a platform that allows for seamless integration with other systems which streamlines coordination, and reduces critical errors

## Intel Components

- Intel® Core™ i7 Processors
- Intel® Core™ i5 Processors
- Intel® Atom™ Processors

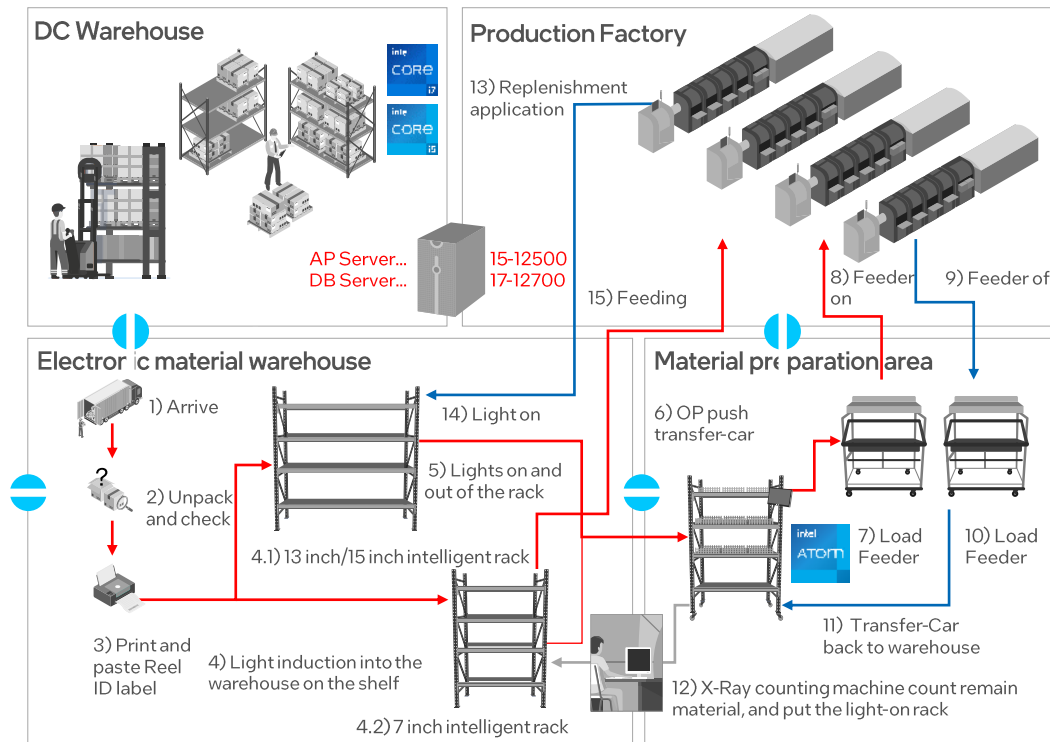

Target Vertical: Manufacturing

Secondary Vertical: Transportation and Warehousing

Target Use Case: Control Optimization & Autonomy

Geo Availability: Asia, Pacific, and Japan, People's Republic of China

### Learn More

- WPI SMT Intelligent Storage Rack Solution Product Video
- WPI SMT Intelligent Smart Storage Rack Solution Product Page



# Wuxi Xinje Vision Guided Intelligent Welding System

## Solution Overview

A solution that provides a truly autonomous welding machine to help customers increase operating hours while improving quality. Machines can be operated without special training and use simple housing placement, machine vision, and 3-D guiding for precise seams.

## Value Props



Improve speed, precision, and reliability with precise welding guidance systems



Reduce costs and manual operating hours by leveraging machines with 3-D vision



Stabilize and improve welding quality robot welding to decrease worker risk

## Intel Components

- Intel® Core™ i5 Processors
- Intel® Atom® Processors
- Intel® Distribution of OpenVINO™ toolkit
- 10gbe Intel® ethernet network adapters

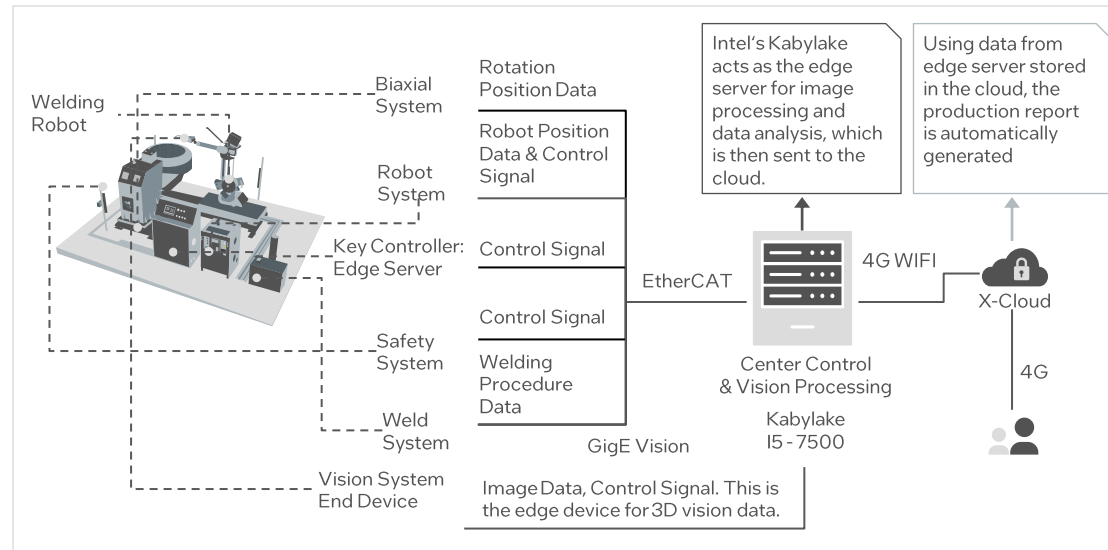

Target Vertical:  
Manufacturing

Target Use Case: Control  
Optimization & Autonomy

Geo Availability  
Available in PRC, NA, EMEA

## Learn More

- [Wuxi Xinje Website](#)
- [Product examples](#)



XESOL innovation

driv|ox®

Back to Manufacturing Solutions

Back to Control Optimization & Autonomy Use Cases



### Solution Overview

The manufacturing industry experiences significant losses in profit and efficiency as a result of work-related accidents. To help mitigate this issue, Xesol has developed Drivox®, a complete ecosystem solution designed to increase safety, avoid risk, and accelerate efficiency for manufacturers. Driven by IoT technology, the solution accurately detects potential collisions between people, machines, and objects, and alerts the operator with a visual and auditory alarm as threats are recognized. Data related to safety metrics is collected from edge devices and sent to the cloud for further analysis where behavior that registers outside of safety compliance standards, such as overaccelerating or vehicle tampering, is documented.

### Value Props

- Help increase worker safety by recognizing and mitigating, through alerts, potential accidents in warehouse environments with IoT sensing
- Optimize manufacturing logistics with an all-in-one ecosystem solution that bolsters productivity by reducing interruptions and incidences
- Minimize direct costs associated with accidents, such as collision damages, production stop, and medical and legal bills

### Intel Components

- Intel® Core™ Processors
- Intel® Xeon® Processors
- Intel® Distribution of OpenVINO™ toolkit
- Intel® CVAT
- Intel® Vtune™
- Intel® OpenCV
- Docker

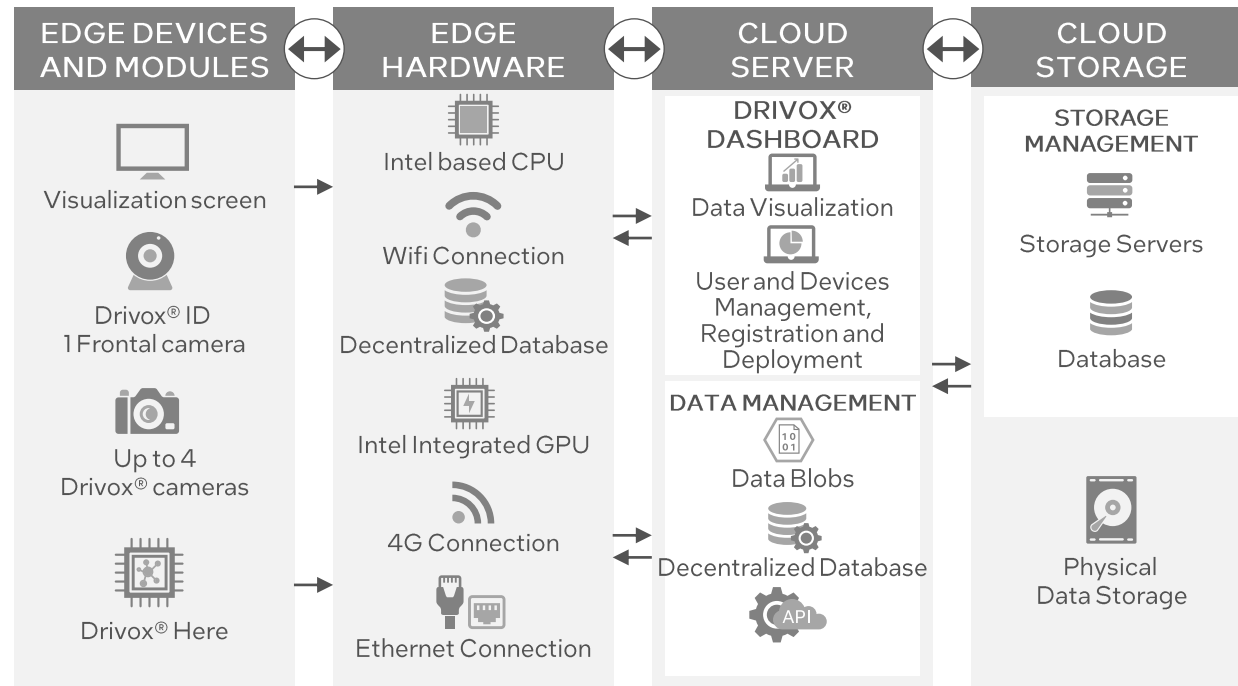

Target Vertical: Manufacturing

Secondary Verticals: Agriculture, Retail, Transportation & Warehousing

Target Use Case: Control Optimization & Autonomy

Geo Availability: Europe, Middle East, and Africa

### Learn More

- [Xesol Drivox Website](#)



# Xinje Electric X-SIGHT: Intelligent Industrial Controller

## Solution Overview

The Xinje Electric X-SIGHT Intelligent Industrial Controller monitors individual PLCs, and streamlines their control through a centralized user interface and programming platform. Through this combination, PLCs can be controlled to perform a wide range of tasks, and actively analyze passthrough data to enhance performance. Xinje works with customers to develop cloud data software and systems for their Intelligent Industrial Controller Integrations. This ensures sound private cloud storage protocols, and a customized level of detail to their customer's unique process, privacy and other data management needs. After identifying and implementing the best integration. Data security can be further managed through a separate runtime environment to process sensitive data, such as computer vision data, for proper oversight.

## Value Props



**Increase operational speed and efficiency** by utilizing a system that centralizes communications between IoT devices, industrial controllers, resources planning software, and other systems



**Enhance production quality** with a system designed to conduct real-time performance analysis, and enact machine learning driven self-improving and self-healing protocols



**Help operators and managers focus on critical tasks** by integrating a reliable, autonomous system that requires less monitoring, and offers users a smooth, easy-to-use unified interface

## Intel Components

- Intel® Celeron®
- Intel® Core i3 – i9® processors
- Intel® Ethernet Controllers
- Intel® Xeon® processors
- Intel® Distribution of OpenVINO™ toolkit

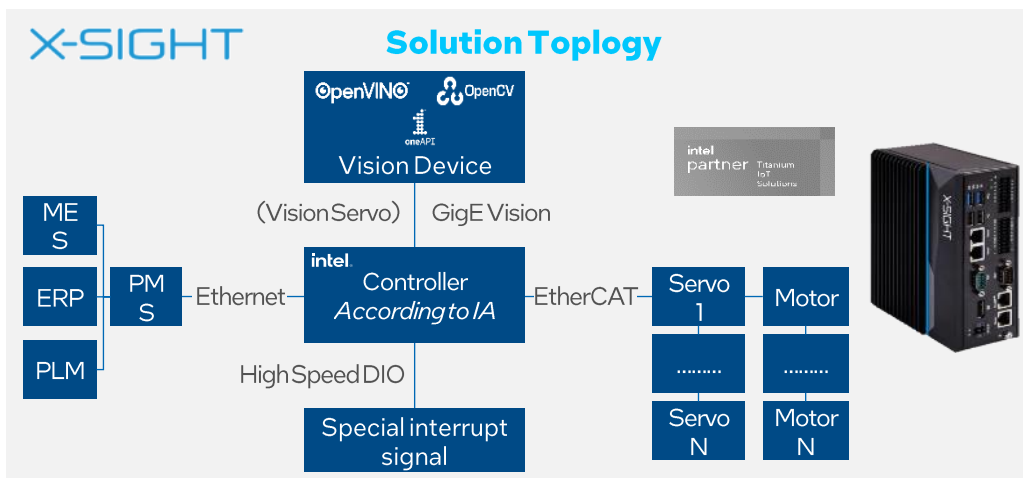

**Target Vertical:**  
[Manufacturing](#)

**Secondary Vertical:**  
[Agriculture](#)

**Target Use Case:**  
[Control Optimization & Autonomy](#)

## Geo Availability

Asia, Pacific, and Japan, Europe, Middle East, and Africa, People's Republic of China

## Learn More

- [Xinje Website](#)
- [Solution Demos](#)
- [Unboxing, Installation, Set-Up](#)



# Yanolja Y FLUX Kiosk Smart Hotel Lobby

## Solution Overview

The Yanolja Y FLUX Kiosk is a fully-integrated smart hotel solution that improves customer experience and management efficiency. The Kiosk enables self check-in, reservations, key issuance, and payment processing. It can also integrate with online booking platforms, enabling hotels to deliver a truly contactless check-in experience.

## Value Props

- Expedite customer service by automating check-in, check-out, and key issuance services
- Create unified experiences by enabling guests to manage their own check-in processes and use their own smartphones as a digital room key
- Streamline operations and reduce costs by automating repetitive tasks so hotel staff can prioritize high-value activities

## Intel Components

Intel® Core™ i7 processors

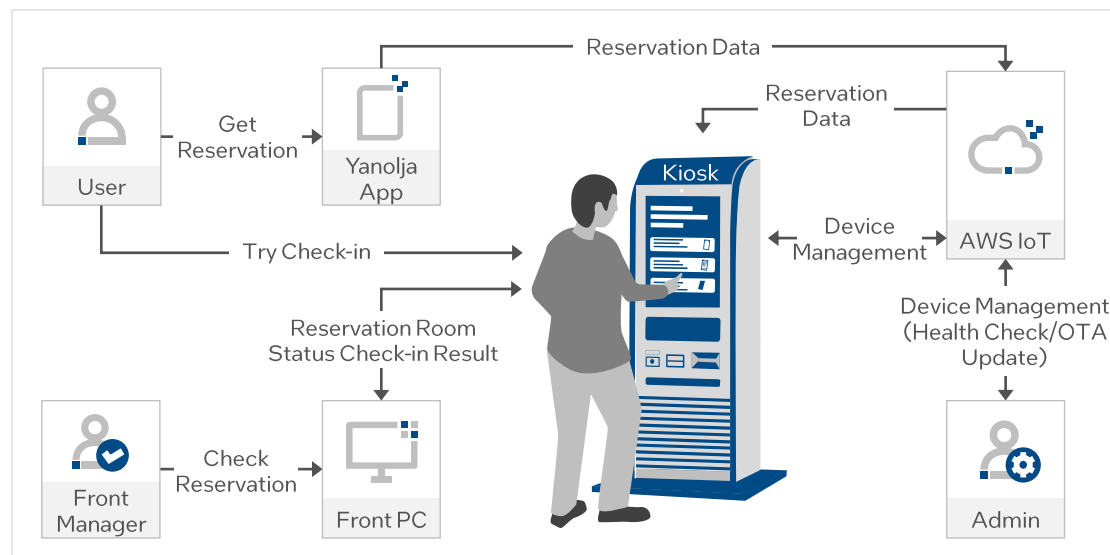

Target Vertical: Hospitality

Target Use Case: Interactive Media

Geo Availability  
Korea

### Learn More

- [Solution Website \(KOR\)](#)
- [Y FLUX Overview Video \(ENG\)](#)

# Yoi System Co., Ltd. i-X (i-ECS: Intelligent-Edge Control System)

## Solution Overview

The Yoi System i-X (i-ECS: Intelligent-Edge Control System) solution offers an edge computing management system that collects, analyzes, and visualizes real-time data generated from IoT sensors and process controllers in smart factories. Designed for manufacturing and industrial use cases, i-X (i-ECS: Intelligent-Edge Control System) offers around-the-clock automated fault detection during data processing, enabling users to optimize operations via remote controls. With this solution, customers can establish an efficient automation environment in their smart factory.

## Value Props

**Improve manufacturing productivity** with a high-performance industrial edge solution that collects, analyzes, and visualizes data in real time

**Enable remote management** by reducing the need for on-site inspection with a one-stop smart solution that uses Yoi system's proprietary software and Intel vPro® tech

**Reduce operational downtime** with a solution that works in real time to enable the quick detection and correction of failures

## Kit Components

- 10th Gen Intel® Core™ Processor Family
- 12th Gen Intel® Core™ Processor Family
- Intel® Xeon® Processors
- Intel vPro® Platform

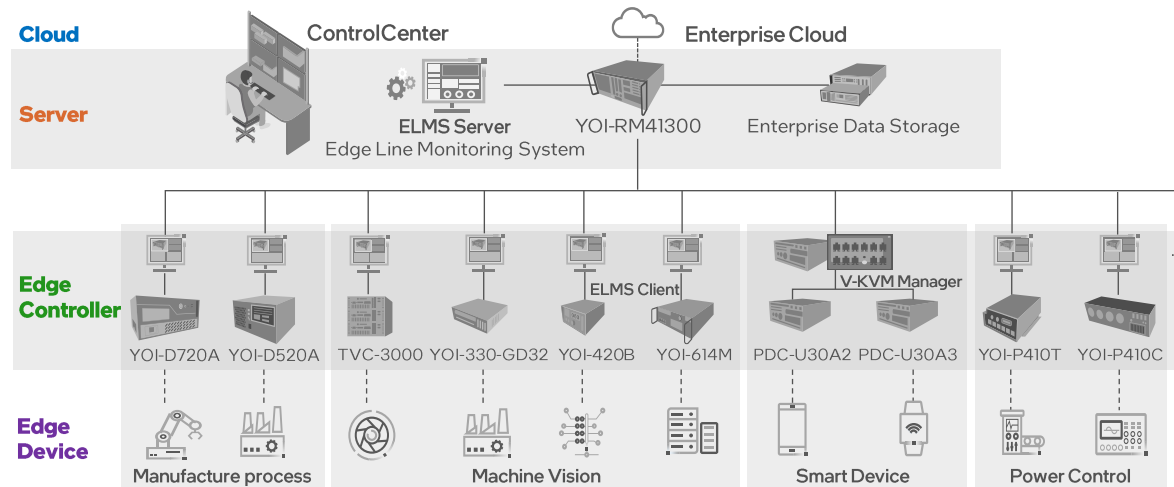

**Target Vertical:**  
Manufacturing

**Target Use Case:**  
Machine Condition Monitoring

**Secondary Use Cases:**  
Control Optimization & Autonomy, Environment Monitoring, Product Inspection, Situational Monitoring, Industrial Computer Condition/Remote Monitoring & Control

**Geo Availability**  
Worldwide

### Learn More

- [Yoi System Website](#)
- [Solution Overview & Demo \(Korean\)](#)





# Zhejiang Jandar Technology Wise Medical Treatment

## Solution Overview

Jandar's Wise Medical Treatment Solution provides various self-service devices for patients and visitors across the hospital for a one-stop central interactive service channel. Employees are also empowered with central management, data, and streamlined processes. The solution plays an important role in the decision-making process of hospital administrators and contributes to optimizing service quality.

## Value Props



Improve decision making for the administrative staff with data and analysis on user behaviors, revenue, and more



Reduce waiting times by empowering patients and visitors with self-service devices



Optimize operations with a central management system and data analysis on Jandar's cloud platform

## Intel Components

Intel® Core™ i5 processors

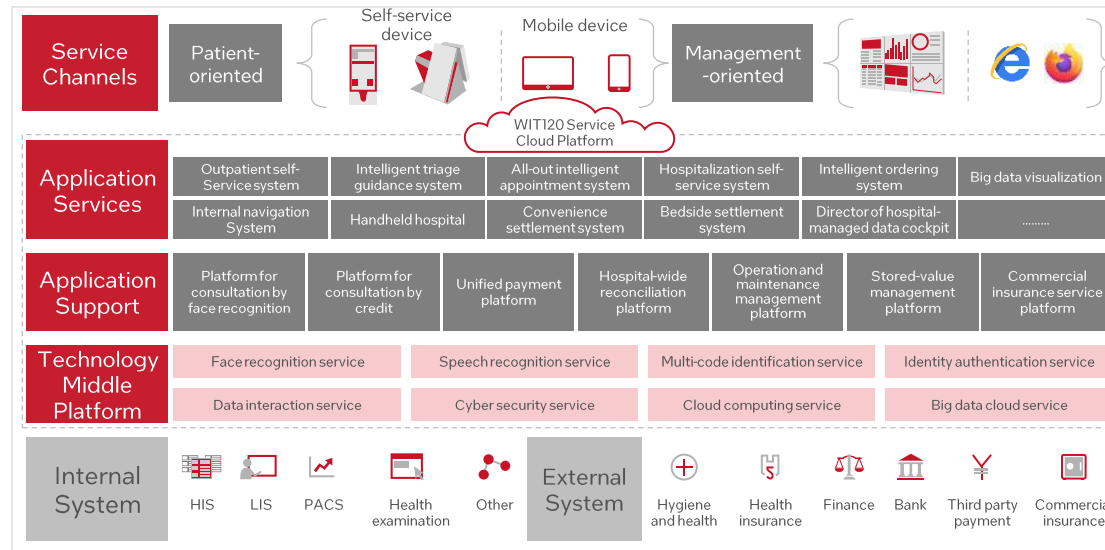

**Target Vertical:** Health & Life Sciences

**Secondary Verticals:** Retail, Government, Hospitality, Transportation

**Target Use Case:** Interactive Media

**Geo Availability:** PRC

**Learn More**

- [Jandar Website](#)



# ZRT Intelligent Medical Image Review and Consultation

## Solution Overview

The solution collects medical imaging and leverages AI to produce 3D models at the edge, performs intelligent data analysis and management, and provides cloud data storage and diagnostic review. It enables customers to overcome challenges with diagnostic reliability, workflow efficiency, and quality of care.

## Value Props

- Increase diagnostic accuracy with AI medical imaging software that leverages IoT-enabled smart lighting
- Improve work efficiency with edge computing, supporting all-in-one terminals and displays, and AI-assistance for diagnosis processes and data management
- Help reduce liability through a solution that minimizes the number of missed diagnoses and misdiagnoses

## Intel Components

- Intel® Core™ i5 Processors
- Intel® Core™ i7 Processors
- Intel® Distribution of OpenVINO™ toolkit
- Intel® Movidius™ VPU

### Solution framework introduction

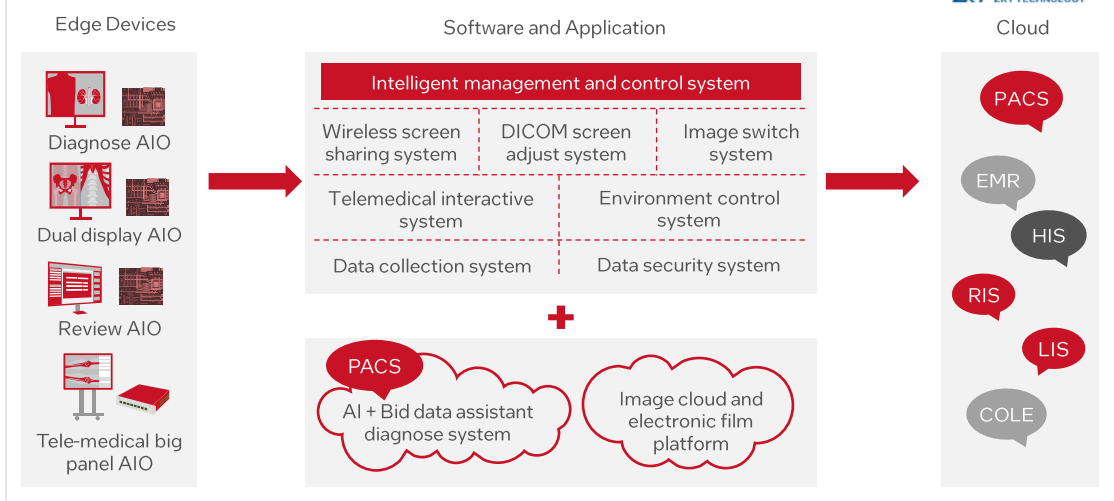

Target Vertical: Health & Life Sciences

Target Use Case: Product Inspection

Geo Availability  
PRC

Learn More

- [ZRT website](#)