



Intel® 64 and IA-32 Architectures Software Developer's Manual

Volume 3C: System Programming Guide, Part 3

NOTE: The *Intel® 64 and IA-32 Architectures Software Developer's Manual* consists of ten volumes: *Basic Architecture*, Order Number 253665; *Instruction Set Reference, A-L*, Order Number 253666; *Instruction Set Reference, M-U*, Order Number 253667; *Instruction Set Reference, V*, Order Number 326018; *Instruction Set Reference, W-Z*, Order Number 334569; *System Programming Guide, Part 1*, Order Number 253668; *System Programming Guide, Part 2*, Order Number 253669; *System Programming Guide, Part 3*, Order Number 326019; *System Programming Guide, Part 4*, Order Number 332831; *Model-Specific Registers*, Order Number 335592. Refer to all ten volumes when evaluating your design needs.

Order Number: 326019-081US
September 2023

Notices & Disclaimers

Intel technologies may require enabled hardware, software or service activation.

No product or component can be absolutely secure.

Your costs and results may vary.

You may not use or facilitate the use of this document in connection with any infringement or other legal analysis concerning Intel products described herein. You agree to grant Intel a non-exclusive, royalty-free license to any patent claim thereafter drafted which includes subject matter disclosed herein.

All product plans and roadmaps are subject to change without notice.

The products described may contain design defects or errors known as errata which may cause the product to deviate from published specifications. Current characterized errata are available on request.

Intel disclaims all express and implied warranties, including without limitation, the implied warranties of merchantability, fitness for a particular purpose, and non-infringement, as well as any warranty arising from course of performance, course of dealing, or usage in trade.

Code names are used by Intel to identify products, technologies, or services that are in development and not publicly available. These are not "commercial" names and not intended to function as trademarks.

No license (express or implied, by estoppel or otherwise) to any intellectual property rights is granted by this document, with the sole exception that a) you may publish an unmodified copy and b) code included in this document is licensed subject to the Zero-Clause BSD open source license (0BSD), <https://opensource.org/licenses/0BSD>. You may create software implementations based on this document and in compliance with the foregoing that are intended to execute on the Intel product(s) referenced in this document. No rights are granted to create modifications or derivatives of this document.

© Intel Corporation. Intel, the Intel logo, and other Intel marks are trademarks of Intel Corporation or its subsidiaries. Other names and brands may be claimed as the property of others.

24.1 OVERVIEW

This chapter describes the basics of virtual machine architecture and an overview of the virtual-machine extensions (VMX) that support virtualization of processor hardware for multiple software environments.

Information about VMX instructions is provided in the Intel® 64 and IA-32 Architectures Software Developer's Manual, Volume 2B. Other aspects of VMX and system programming considerations are described in chapters of Intel® 64 and IA-32 Architectures Software Developer's Manual, Volume 3C.

24.2 VIRTUAL MACHINE ARCHITECTURE

Virtual-machine extensions define processor-level support for virtual machines on IA-32 processors. Two principal classes of software are supported:

- **Virtual-machine monitors (VMM)** — A VMM acts as a host and has full control of the processor(s) and other platform hardware. A VMM presents guest software (see next paragraph) with an abstraction of a virtual processor and allows it to execute directly on a logical processor. A VMM is able to retain selective control of processor resources, physical memory, interrupt management, and I/O.
- **Guest software** — Each virtual machine (VM) is a guest software environment that supports a stack consisting of operating system (OS) and application software. Each operates independently of other virtual machines and uses on the same interface to processor(s), memory, storage, graphics, and I/O provided by a physical platform. The software stack acts as if it were running on a platform with no VMM. Software executing in a virtual machine must operate with reduced privilege so that the VMM can retain control of platform resources.

24.3 INTRODUCTION TO VMX OPERATION

Processor support for virtualization is provided by a form of processor operation called VMX operation. There are two kinds of VMX operation: VMX root operation and VMX non-root operation. In general, a VMM will run in VMX root operation and guest software will run in VMX non-root operation. Transitions between VMX root operation and VMX non-root operation are called VMX transitions. There are two kinds of VMX transitions. Transitions into VMX non-root operation are called VM entries. Transitions from VMX non-root operation to VMX root operation are called VM exits.

Processor behavior in VMX root operation is very much as it is outside VMX operation. The principal differences are that a set of new instructions (the VMX instructions) is available and that the values that can be loaded into certain control registers are limited (see Section 24.8).

Processor behavior in VMX non-root operation is restricted and modified to facilitate virtualization. Instead of their ordinary operation, certain instructions (including the new VMCALL instruction) and events cause VM exits to the VMM. Because these VM exits replace ordinary behavior, the functionality of software in VMX non-root operation is limited. It is this limitation that allows the VMM to retain control of processor resources.

There is no software-visible bit whose setting indicates whether a logical processor is in VMX non-root operation. This fact may allow a VMM to prevent guest software from determining that it is running in a virtual machine.

Because VMX operation places restrictions even on software running with current privilege level (CPL) 0, guest software can run at the privilege level for which it was originally designed. This capability may simplify the development of a VMM.

24.4 LIFE CYCLE OF VMM SOFTWARE

Figure 24-1 illustrates the life cycle of a VMM and its guest software as well as the interactions between them. The following items summarize that life cycle:

- Software enters VMX operation by executing a VMXON instruction.
- Using VM entries, a VMM can then enter guests into virtual machines (one at a time). The VMM effects a VM entry using instructions VMLAUNCH and VMRESUME; it regains control using VM exits.
- VM exits transfer control to an entry point specified by the VMM. The VMM can take action appropriate to the cause of the VM exit and can then return to the virtual machine using a VM entry.
- Eventually, the VMM may decide to shut itself down and leave VMX operation. It does so by executing the VMXOFF instruction.

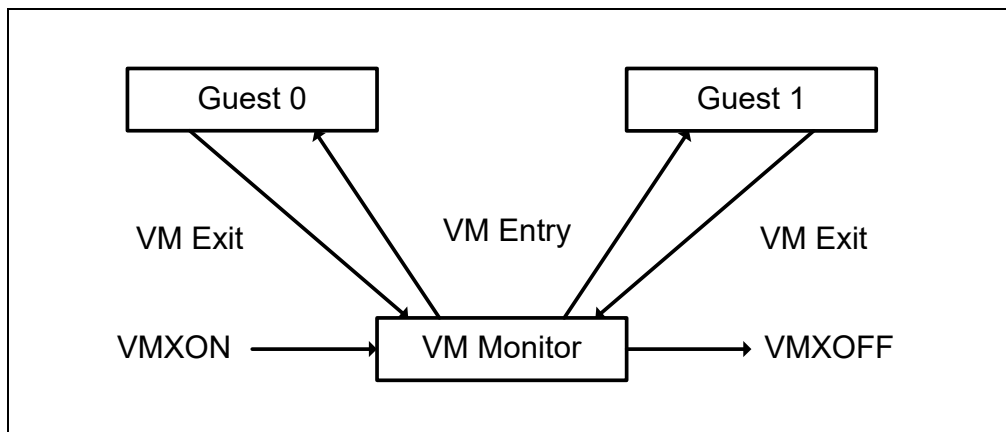

Figure 24-1. Interaction of a Virtual-Machine Monitor and Guests

24.5 VIRTUAL-MACHINE CONTROL STRUCTURE

VMX non-root operation and VMX transitions are controlled by a data structure called a virtual-machine control structure (VMCS).

Access to the VMCS is managed through a component of processor state called the VMCS pointer (one per logical processor). The value of the VMCS pointer is the 64-bit address of the VMCS. The VMCS pointer is read and written using the instructions VMPTRST and VMPTRLD. The VMM configures a VMCS using the VMREAD, VMWRITE, and VMCLEAR instructions.

A VMM could use a different VMCS for each virtual machine that it supports. For a virtual machine with multiple logical processors (virtual processors), the VMM could use a different VMCS for each virtual processor.

24.6 DISCOVERING SUPPORT FOR VMX

Before system software enters into VMX operation, it must discover the presence of VMX support in the processor. System software can determine whether a processor supports VMX operation using CPUID. If CPUID.1:ECX.VMX[bit 5] = 1, then VMX operation is supported. See Chapter 3, “Instruction Set Reference, A-L,” of the Intel® 64 and IA-32 Architectures Software Developer’s Manual, Volume 2A.

The VMX architecture is designed to be extensible so that future processors in VMX operation can support additional features not present in first-generation implementations of the VMX architecture. The availability of extensible VMX features is reported to software using a set of VMX capability MSRs (see Appendix A, “VMX Capability Reporting Facility”).

24.7 ENABLING AND ENTERING VMX OPERATION

Before system software can enter VMX operation, it enables VMX by setting `CR4.VMXE[bit 13] = 1`. VMX operation is then entered by executing the `VMXON` instruction. `VMXON` causes an invalid-opcode exception (`#UD`) if executed with `CR4.VMXE = 0`. Once in VMX operation, it is not possible to clear `CR4.VMXE` (see Section 24.8). System software leaves VMX operation by executing the `VMXOFF` instruction. `CR4.VMXE` can be cleared outside of VMX operation after executing of `VMXOFF`.

`VMXON` is also controlled by the `IA32_FEATURE_CONTROL` MSR (MSR address 3AH). This MSR is cleared to zero when a logical processor is reset. The relevant bits of the MSR are:

- **Bit 0 is the lock bit.** If this bit is clear, `VMXON` causes a general-protection exception. If the lock bit is set, `WRMSR` to this MSR causes a general-protection exception; the MSR cannot be modified until a power-up reset condition. System BIOS can use this bit to provide a setup option for BIOS to disable support for VMX. To enable VMX support in a platform, BIOS must set bit 1, bit 2, or both (see below), as well as the lock bit.
- **Bit 1 enables VMXON in SMX operation.** If this bit is clear, execution of `VMXON` in SMX operation causes a general-protection exception. Attempts to set this bit on logical processors that do not support both VMX operation (see Section 24.6) and SMX operation (see Chapter 7, “Safer Mode Extensions Reference,” in the Intel® 64 and IA-32 Architectures Software Developer’s Manual, Volume 2D) cause general-protection exceptions.
- **Bit 2 enables VMXON outside SMX operation.** If this bit is clear, execution of `VMXON` outside SMX operation causes a general-protection exception. Attempts to set this bit on logical processors that do not support VMX operation (see Section 24.6) cause general-protection exceptions.

NOTE

A logical processor is in SMX operation if `GETSEC[SEXIT]` has not been executed since the last execution of `GETSEC[SENTER]`. A logical processor is outside SMX operation if `GETSEC[SENTER]` has not been executed or if `GETSEC[SEXIT]` was executed after the last execution of `GETSEC[SENTER]`. See Chapter 7, “Safer Mode Extensions Reference,” in Intel® 64 and IA-32 Architectures Software Developer’s Manual, Volume 2D.

Before executing `VMXON`, software should allocate a naturally aligned 4-KByte region of memory that a logical processor may use to support VMX operation.¹ This region is called the **VMXON region**. The address of the VMXON region (the VMXON pointer) is provided in an operand to `VMXON`. Section 25.11.5, “VMXON Region,” details how software should initialize and access the VMXON region.

24.8 RESTRICTIONS ON VMX OPERATION

VMX operation places restrictions on processor operation. These are detailed below:

- In VMX operation, processors may fix certain bits in `CR0` and `CR4` to specific values and not support other values. `VMXON` fails if any of these bits contains an unsupported value (see “VMXON—Enter VMX Operation” in Chapter 31). Any attempt to set one of these bits to an unsupported value while in VMX operation (including VMX root operation) using any of the `CLTS`, `LMSW`, or `MOV CR` instructions causes a general-protection exception. VM entry or VM exit cannot set any of these bits to an unsupported value. Software should consult the VMX capability MSRs `IA32_VMX_CR0_FIXED0` and `IA32_VMX_CR0_FIXED1` to determine how bits in `CR0` are fixed (see Appendix A.7). For `CR4`, software should consult the VMX capability MSRs `IA32_VMX_CR4_FIXED0` and `IA32_VMX_CR4_FIXED1` (see Appendix A.8).

NOTES

The first processors to support VMX operation require that the following bits be 1 in VMX operation: `CR0.PE`, `CR0.NE`, `CR0.PG`, and `CR4.VMXE`. The restrictions on `CR0.PE` and `CR0.PG` imply that VMX

1. Future processors may require that a different amount of memory be reserved. If so, this fact is reported to software using the VMX capability-reporting mechanism.

operation is supported only in paged protected mode (including IA-32e mode). Therefore, guest software cannot be run in unpagged protected mode or in real-address mode.

Later processors support a VM-execution control called “unrestricted guest” (see Section 25.6.2). If this control is 1, CR0.PE and CR0.PG may be 0 in VMX non-root operation (even if the capability MSR IA32_VMX_CR0_FIXED0 reports otherwise).¹ Such processors allow guest software to run in unpagged protected mode or in real-address mode.

- VMXON fails if a logical processor is in A20M mode (see “VMXON—Enter VMX Operation” in Chapter 31). Once the processor is in VMX operation, A20M interrupts are blocked. Thus, it is impossible to be in A20M mode in VMX operation.
- The INIT signal is blocked whenever a logical processor is in VMX root operation. It is not blocked in VMX non-root operation. Instead, INITs cause VM exits (see Section 26.2, “Other Causes of VM Exits”).
- Intel[®] Processor Trace (Intel PT) can be used in VMX operation only if IA32_VMX_MISC[14] is read as 1 (see Appendix A.6). On processors that support Intel PT but which do not allow it to be used in VMX operation, execution of VMXON clears IA32_RTIT_CTL.TraceEn (see “VMXON—Enter VMX Operation” in Chapter 31); any attempt to write IA32_RTIT_CTL while in VMX operation (including VMX root operation) causes a general-protection exception.

1. “Unrestricted guest” is a secondary processor-based VM-execution control. If bit 31 of the primary processor-based VM-execution controls is 0, VMX non-root operation functions as if the “unrestricted guest” VM-execution control were 0. See Section 25.6.2.

25.1 OVERVIEW

A logical processor uses **virtual-machine control data structures (VMCSs)** while it is in VMX operation. These manage transitions into and out of VMX non-root operation (VM entries and VM exits) as well as processor behavior in VMX non-root operation. This structure is manipulated by the new instructions VMCLEAR, VMPTRLD, VMREAD, and VMWRITE.

A VMM can use a different VMCS for each virtual machine that it supports. For a virtual machine with multiple logical processors (virtual processors), the VMM can use a different VMCS for each virtual processor.

A logical processor associates a region in memory with each VMCS. This region is called the **VMCS region**.¹ Software references a specific VMCS using the 64-bit physical address of the region (a **VMCS pointer**). VMCS pointers must be aligned on a 4-KByte boundary (bits 11:0 must be zero). These pointers must not set bits beyond the processor's physical-address width.^{2,3}

A logical processor may maintain a number of VMCSs that are **active**. The processor may optimize VMX operation by maintaining the state of an active VMCS in memory, on the processor, or both. At any given time, at most one of the active VMCSs is the **current** VMCS. (This document frequently uses the term "the VMCS" to refer to the current VMCS.) The VMLAUNCH, VMREAD, VMRESUME, and VMWRITE instructions operate only on the current VMCS.

The following items describe how a logical processor determines which VMCSs are active and which is current:

- The memory operand of the VMPTRLD instruction is the address of a VMCS. After execution of the instruction, that VMCS is both active and current on the logical processor. Any other VMCS that had been active remains so, but no other VMCS is current.
- The VMCS link pointer field in the current VMCS (see Section 1.4.2) is itself the address of a VMCS. If VM entry is performed successfully with the 1-setting of the "VMCS shadowing" VM-execution control, the VMCS referenced by the VMCS link pointer field becomes active on the logical processor. The identity of the current VMCS does not change.
- The memory operand of the VMCLEAR instruction is also the address of a VMCS. After execution of the instruction, that VMCS is neither active nor current on the logical processor. If the VMCS had been current on the logical processor, the logical processor no longer has a current VMCS.

The VMPTRST instruction stores the address of the logical processor's current VMCS into a specified memory location (it stores the value FFFFFFFF_FFFFFFFFH if there is no current VMCS).

The **launch state** of a VMCS determines which VM-entry instruction should be used with that VMCS: the VMLAUNCH instruction requires a VMCS whose launch state is "clear"; the VMRESUME instruction requires a VMCS whose launch state is "launched". A logical processor maintains a VMCS's launch state in the corresponding VMCS region. The following items describe how a logical processor manages the launch state of a VMCS:

- If the launch state of the current VMCS is "clear", successful execution of the VMLAUNCH instruction changes the launch state to "launched".
- The memory operand of the VMCLEAR instruction is the address of a VMCS. After execution of the instruction, the launch state of that VMCS is "clear".
- There are no other ways to modify the launch state of a VMCS (it cannot be modified using VMWRITE) and there is no direct way to discover it (it cannot be read using VMREAD).

1. The amount of memory required for a VMCS region is at most 4 KBytes. The exact size is implementation specific and can be determined by consulting the VMX capability MSR IA32_VMX_BASIC to determine the size of the VMCS region (see Appendix A.1).

2. Software can determine a processor's physical-address width by executing CPUID with 80000008H in EAX. The physical-address width is returned in bits 7:0 of EAX.

3. If IA32_VMX_BASIC[48] is read as 1, these pointers must not set any bits in the range 63:32; see Appendix A.1.

Figure 1-1 illustrates the different states of a VMCS. It uses “X” to refer to the VMCS and “Y” to refer to any other VMCS. Thus: “VMPTRLD X” always makes X current and active; “VMPTRLD Y” always makes X not current (because it makes Y current); VMLAUNCH makes the launch state of X “launched” if X was current and its launch state was “clear”; and VMCLEAR X always makes X inactive and not current and makes its launch state “clear”.

The figure does not illustrate operations that do not modify the VMCS state relative to these parameters (e.g., execution of VMPTRLD X when X is already current). Note that VMCLEAR X makes X “inactive, not current, and clear,” even if X’s current state is not defined (e.g., even if X has not yet been initialized). See Section 1.11.3.

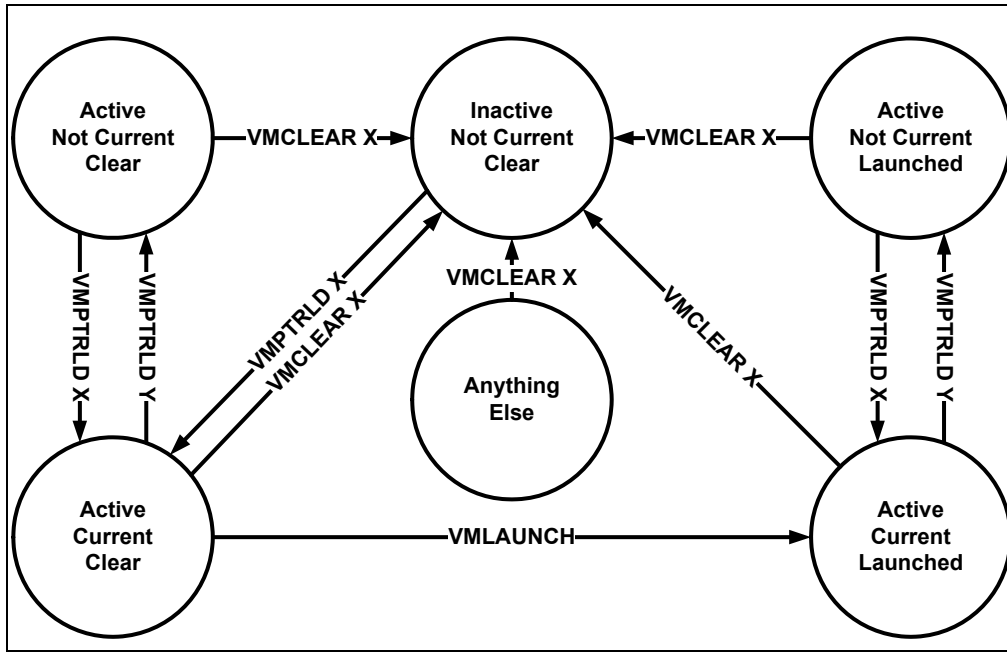

Figure 25-1. States of VMCS X

Because a shadow VMCS (see Section 1.10) cannot be used for VM entry, the launch state of a shadow VMCS is not meaningful. Figure 1-1 does not illustrate all the ways in which a shadow VMCS may be made active.

25.2 FORMAT OF THE VMCS REGION

A VMCS region comprises up to 4-KBytes.¹ The format of a VMCS region is given in Table 1-1.

Table 25-1. Format of the VMCS Region

Byte Offset	Contents
0	Bits 30:0: VMCS revision identifier Bit 31: shadow-VMCS indicator (see Section 1.10)
4	VMX-abort indicator
8	VMCS data (implementation-specific format)

1. The exact size is implementation specific and can be determined by consulting the VMX capability MSR IA32_VMX_BASIC to determine the size of the VMCS region (see Appendix A.1).

The first 4 bytes of the VMCS region contain the **VMCS revision identifier** at bits 30:0.¹ Processors that maintain VMCS data in different formats (see below) use different VMCS revision identifiers. These identifiers enable software to avoid using a VMCS region formatted for one processor on a processor that uses a different format.² Bit 31 of this 4-byte region indicates whether the VMCS is a shadow VMCS (see Section 1.10).

Software should write the VMCS revision identifier to the VMCS region before using that region for a VMCS. The VMCS revision identifier is never written by the processor; VMPTRLD fails if its operand references a VMCS region whose VMCS revision identifier differs from that used by the processor. (VMPTRLD also fails if the shadow-VMCS indicator is 1 and the processor does not support the 1-setting of the “VMCS shadowing” VM-execution control; see Section 1.6.2) Software can discover the VMCS revision identifier that a processor uses by reading the VMX capability MSR IA32_VMX_BASIC (see Appendix A.1).

Software should clear or set the shadow-VMCS indicator depending on whether the VMCS is to be an ordinary VMCS or a shadow VMCS (see Section 1.10). VMPTRLD fails if the shadow-VMCS indicator is set and the processor does not support the 1-setting of the “VMCS shadowing” VM-execution control. Software can discover support for this setting by reading the VMX capability MSR IA32_VMX_PROCBASED_CTL2 (see Appendix A.3.3).

The next 4 bytes of the VMCS region are used for the **VMX-abort indicator**. The contents of these bits do not control processor operation in any way. A logical processor writes a non-zero value into these bits if a VMX abort occurs (see Section 28.7). Software may also write into this field.

The remainder of the VMCS region is used for **VMCS data** (those parts of the VMCS that control VMX non-root operation and the VMX transitions). The format of these data is implementation-specific. VMCS data are discussed in Section 1.3 through Section 1.9. To ensure proper behavior in VMX operation, software should maintain the VMCS region and related structures (enumerated in Section 1.11.4) in writeback cacheable memory. Future implementations may allow or require a different memory type³. Software should consult the VMX capability MSR IA32_VMX_BASIC (see Appendix A.1).

25.3 ORGANIZATION OF VMCS DATA

The VMCS data are organized into six logical groups:

- **Guest-state area.** Processor state is saved into the guest-state area on VM exits and loaded from there on VM entries.
- **Host-state area.** Processor state is loaded from the host-state area on VM exits.
- **VM-execution control fields.** These fields control processor behavior in VMX non-root operation. They determine in part the causes of VM exits.
- **VM-exit control fields.** These fields control VM exits.
- **VM-entry control fields.** These fields control VM entries.
- **VM-exit information fields.** These fields receive information on VM exits and describe the cause and the nature of VM exits. On some processors, these fields are read-only.⁴

The VM-execution control fields, the VM-exit control fields, and the VM-entry control fields are sometimes referred to collectively as VMX controls.

-
1. Earlier versions of this manual specified that the VMCS revision identifier was a 32-bit field. For all processors produced prior to this change, bit 31 of the VMCS revision identifier was 0.
 2. Logical processors that use the same VMCS revision identifier use the same size for VMCS regions.
 3. Alternatively, software may map any of these regions or structures with the UC memory type. Doing so is strongly discouraged unless necessary as it will cause the performance of transitions using those structures to suffer significantly. In addition, the processor will continue to use the memory type reported in the VMX capability MSR IA32_VMX_BASIC with exceptions noted in Appendix A.1.
 4. Software can discover whether these fields can be written by reading the VMX capability MSR IA32_VMX_MISC (see Appendix A.6).

25.4 GUEST-STATE AREA

This section describes fields contained in the guest-state area of the VMCS. VM entries load processor state from these fields and VM exits store processor state into these fields. See Section 27.3.2 and Section 28.3 for details.

25.4.1 Guest Register State

The following fields in the guest-state area correspond to processor registers:

- Control registers CR0, CR3, and CR4 (64 bits each; 32 bits on processors that do not support Intel 64 architecture).
- Debug register DR7 (64 bits; 32 bits on processors that do not support Intel 64 architecture).
- RSP, RIP, and RFLAGS (64 bits each; 32 bits on processors that do not support Intel 64 architecture).¹
- The following fields for each of the registers CS, SS, DS, ES, FS, GS, LDTR, and TR:
 - Selector (16 bits).
 - Base address (64 bits; 32 bits on processors that do not support Intel 64 architecture). The base-address fields for CS, SS, DS, and ES have only 32 architecturally-defined bits; nevertheless, the corresponding VMCS fields have 64 bits on processors that support Intel 64 architecture.
 - Segment limit (32 bits). The limit field is always a measure in bytes.
 - Access rights (32 bits). The format of this field is given in Table 1-2 and detailed as follows:
 - The low 16 bits correspond to bits 23:8 of the upper 32 bits of a 64-bit segment descriptor. While bits 19:16 of code-segment and data-segment descriptors correspond to the upper 4 bits of the segment limit, the corresponding bits (bits 11:8) are reserved in this VMCS field.
 - Bit 16 indicates an **unusable segment**. Attempts to use such a segment fault except in 64-bit mode. In general, a segment register is unusable if it has been loaded with a null selector.²
 - Bits 31:17 are reserved.

Table 25-2. Format of Access Rights

Bit Position(s)	Field
3:0	Segment type
4	S — Descriptor type (0 = system; 1 = code or data)
6:5	DPL — Descriptor privilege level
7	P — Segment present
11:8	Reserved
12	AVL — Available for use by system software

1. This chapter uses the notation RAX, RIP, RSP, RFLAGS, etc. for processor registers because most processors that support VMX operation also support Intel 64 architecture. For processors that do not support Intel 64 architecture, this notation refers to the 32-bit forms of those registers (EAX, EIP, ESP, EFLAGS, etc.). In a few places, notation such as EAX is used to refer specifically to lower 32 bits of the indicated register.

2. There are a few exceptions to this statement. For example, a segment with a non-null selector may be unusable following a task switch that fails after its commit point; see “Interrupt 10—Invalid TSS Exception (#TS)” in Section 6.14, “Exception and Interrupt Handling in 64-bit Mode,” of the Intel® 64 and IA-32 Architectures Software Developer’s Manual, Volume 3A. In contrast, the TR register is usable after processor reset despite having a null selector; see Table 11-1 in the Intel® 64 and IA-32 Architectures Software Developer’s Manual, Volume 3A.

Table 25-2. Format of Access Rights (Contd.)

Bit Position(s)	Field
13	Reserved (except for CS) L — 64-bit mode active (for CS only)
14	D/B — Default operation size (0 = 16-bit segment; 1 = 32-bit segment)
15	G — Granularity
16	Segment unusable (0 = usable; 1 = unusable)
31:17	Reserved

The base address, segment limit, and access rights compose the “hidden” part (or “descriptor cache”) of each segment register. These data are included in the VMCS because it is possible for a segment register’s descriptor cache to be inconsistent with the segment descriptor in memory (in the GDT or the LDT) referenced by the segment register’s selector.

The value of the DPL field for SS is always equal to the logical processor’s current privilege level (CPL).¹

On some processors, executions of VMWRITE ignore attempts to write non-zero values to any of bits 11:8 or bits 31:17. On such processors, VMREAD always returns 0 for those bits, and VM entry treats those bits as if they were all 0 (see Section 27.3.1.2).

- The following fields for each of the registers GDTR and IDTR:
 - Base address (64 bits; 32 bits on processors that do not support Intel 64 architecture).
 - Limit (32 bits). The limit fields contain 32 bits even though these fields are specified as only 16 bits in the architecture.
- The following MSRs:
 - IA32_DEBUGCTL (64 bits)
 - IA32_SYSENTER_CS (32 bits)
 - IA32_SYSENTER_ESP and IA32_SYSENTER_EIP (64 bits; 32 bits on processors that do not support Intel 64 architecture)
 - IA32_PERF_GLOBAL_CTRL (64 bits). This field is supported only on processors that support the 1-setting of the “load IA32_PERF_GLOBAL_CTRL” VM-entry control.
 - IA32_PAT (64 bits). This field is supported only on processors that support either the 1-setting of the “load IA32_PAT” VM-entry control or that of the “save IA32_PAT” VM-exit control.
 - IA32_EFER (64 bits). This field is supported only on processors that support either the 1-setting of the “load IA32_EFER” VM-entry control or that of the “save IA32_EFER” VM-exit control.
 - IA32_BNDCFGS (64 bits). This field is supported only on processors that support either the 1-setting of the “load IA32_BNDCFGS” VM-entry control or that of the “clear IA32_BNDCFGS” VM-exit control.
 - IA32_RTIT_CTL (64 bits). This field is supported only on processors that support either the 1-setting of the “load IA32_RTIT_CTL” VM-entry control or that of the “clear IA32_RTIT_CTL” VM-exit control.
 - IA32_LBR_CTL (64 bits). This field is supported only on processors that support either the 1-setting of the “load guest IA32_LBR_CTL” VM-entry control or that of the “clear IA32_LBR_CTL” VM-exit control.
 - IA32_S_CET (64 bits; 32 bits on processors that do not support Intel 64 architecture). This field is supported only on processors that support the 1-setting of the “load CET state” VM-entry control.
 - IA32_INTERRUPT_SSP_TABLE_ADDR (64 bits; 32 bits on processors that do not support Intel 64 architecture). This field is supported only on processors that support the 1-setting of the “load CET state” VM-entry control.

1. In protected mode, CPL is also associated with the RPL field in the CS selector. However, the RPL fields are not meaningful in real-address mode or in virtual-8086 mode.

- IA32_PKRS (64 bits). This field is supported only on processors that support the 1-setting of the “load PKRS” VM-entry control.
- The shadow-stack pointer register SSP (64 bits; 32 bits on processors that do not support Intel 64 architecture). This field is supported only on processors that support the 1-setting of the “load CET state” VM-entry control.
- The register SMBASE (32 bits). This register contains the base address of the logical processor’s SMRAM image.

25.4.2 Guest Non-Register State

In addition to the register state described in Section 1.4.1, the guest-state area includes the following fields that characterize guest state but which do not correspond to processor registers:

- **Activity state** (32 bits). This field identifies the logical processor’s activity state. When a logical processor is executing instructions normally, it is in the **active state**. Execution of certain instructions and the occurrence of certain events may cause a logical processor to transition to an **inactive state** in which it ceases to execute instructions.

The following activity states are defined:¹

- 0: **Active**. The logical processor is executing instructions normally.
- 1: **HLT**. The logical processor is inactive because it executed the HLT instruction.
- 2: **Shutdown**. The logical processor is inactive because it incurred a **triple fault**² or some other serious error.
- 3: **Wait-for-SIPI**. The logical processor is inactive because it is waiting for a startup-IPI (SIPI).

Future processors may include support for other activity states. Software should read the VMX capability MSR IA32_VMX_MISC (see Appendix A.6) to determine what activity states are supported.

- **Interruptibility state** (32 bits). The IA-32 architecture includes features that permit certain events to be blocked for a period of time. This field contains information about such blocking. Details and the format of this field are given in Table 1-3.

Table 25-3. Format of Interruptibility State

Bit Position(s)	Bit Name	Notes
0	Blocking by STI	See the “STI—Set Interrupt Flag” section in Chapter 4 of the Intel® 64 and IA-32 Architectures Software Developer’s Manual, Volume 2B. Execution of STI with RFLAGS.IF = 0 blocks maskable interrupts on the instruction boundary following its execution. ¹ Setting this bit indicates that this blocking is in effect.
1	Blocking by MOV SS	See Section 6.8.3, “Masking Exceptions and Interrupts When Switching Stacks,” in the Intel® 64 and IA-32 Architectures Software Developer’s Manual, Volume 3A. Execution of a MOV to SS or a POP to SS blocks or suppresses certain debug exceptions as well as interrupts (maskable and nonmaskable) on the instruction boundary following its execution. Setting this bit indicates that this blocking is in effect. ² This document uses the term “blocking by MOV SS,” but it applies equally to POP SS.
2	Blocking by SMI	See Section 32.2, “System Management Interrupt (SMI).” System-management interrupts (SMIs) are disabled while the processor is in system-management mode (SMM). Setting this bit indicates that blocking of SMIs is in effect.

1. Execution of the MWAIT instruction may put a logical processor into an inactive state. However, this VMCS field never reflects this state. See Section 28.1.
 2. A triple fault occurs when a logical processor encounters an exception while attempting to deliver a double fault.

Table 25-3. Format of Interruptibility State (Contd.)

Bit Position(s)	Bit Name	Notes
3	Blocking by NMI	See Section 6.7.1, “Handling Multiple NMIs,” in the Intel® 64 and IA-32 Architectures Software Developer’s Manual, Volume 3A and Section 32.8, “NMI Handling While in SMM.” Delivery of a non-maskable interrupt (NMI) or a system-management interrupt (SMI) blocks subsequent NMIs until the next execution of IRET. See Section 26.3 for how this behavior of IRET may change in VMX non-root operation. Setting this bit indicates that blocking of NMIs is in effect. Clearing this bit does not imply that NMIs are not (temporarily) blocked for other reasons. If the “virtual NMIs” VM-execution control (see Section 1.6.1) is 1, this bit does not control the blocking of NMIs. Instead, it refers to “virtual-NMI blocking” (the fact that guest software is not ready for an NMI).
4	Enclave interruption	Set to 1 if the VM exit occurred while the logical processor was in enclave mode. Such VM exits includes those caused by interrupts, non-maskable interrupts, system-management interrupts, INIT signals, and exceptions occurring in enclave mode as well as exceptions encountered during the delivery of such events incident to enclave mode. A VM exit that is incident to delivery of an event injected by VM entry leaves this bit unmodified.
31:5	Reserved	VM entry will fail if these bits are not 0. See Section 27.3.1.5.

NOTES:

1. Nonmaskable interrupts and system-management interrupts may also be inhibited on the instruction boundary following such an execution of STI.
 2. System-management interrupts may also be inhibited on the instruction boundary following such an execution of MOV or POP.
- **Pending debug exceptions** (64 bits; 32 bits on processors that do not support Intel 64 architecture). IA-32 processors may recognize one or more debug exceptions without immediately delivering them.¹ This field contains information about such exceptions. This field is described in Table 1-4.

Table 25-4. Format of Pending-Debug-Exceptions

Bit Position(s)	Bit Name	Notes
3:0	B3 - B0	When set, each of these bits indicates that the corresponding breakpoint condition was met. Any of these bits may be set even if the corresponding enabling bit in DR7 is not set.
10:4	Reserved	VM entry fails if these bits are not 0. See Section 27.3.1.5.
11	BLD	When set, this bit indicates that a bus lock was asserted while OS bus-lock detection was enabled and CPL > 0 (see Section 18.3.1.6, “OS Bus-Lock Detection”). ¹
12	Enabled breakpoint	When set, this bit indicates that at least one data or I/O breakpoint was met and was enabled in DR7; the XBEGIN instruction was executed immediately before the VM exit and advanced debugging of RTM transactional regions had been enabled; or a bus lock was asserted while CPL > 0 and OS bus-lock detection had been enabled.
13	Reserved	VM entry fails if this bit is not 0. See Section 27.3.1.5.

1. For example, execution of a MOV to SS or a POP to SS may inhibit some debug exceptions for one instruction. See Section 6.8.3 of Intel® 64 and IA-32 Architectures Software Developer’s Manual, Volume 3A. In addition, certain events incident to an instruction (for example, an INIT signal) may take priority over debug traps generated by that instruction. See Table 6-2 in the Intel® 64 and IA-32 Architectures Software Developer’s Manual, Volume 3A.

Table 25-4. Format of Pending-Debug-Exceptions (Contd.)

Bit Position(s)	Bit Name	Notes
14	BS	When set, this bit indicates that a debug exception would have been triggered by single-step execution mode.
15	Reserved	VM entry fails if this bit is not 0. See Section 27.3.1.5.
16	RTM	When set, this bit indicates that a debug exception (#DB) or a breakpoint exception (#BP) occurred inside an RTM region while advanced debugging of RTM transactional regions was enabled (see Section 16.3.7, "RTM-Enabled Debugger Support," of Intel® 64 and IA-32 Architectures Software Developer’s Manual, Volume 1). ²
63:17	Reserved	VM entry fails if these bits are not 0. See Section 27.3.1.5. Bits 63:32 exist only on processors that support Intel 64 architecture.

NOTES:

1. In general, the format of this field matches that of DR6. However, DR6 **clears** bit 11 to indicate detection of a bus lock, while this field **sets** the bit to indicate that condition.
2. In general, the format of this field matches that of DR6. However, DR6 **clears** bit 16 to indicate an RTM-related exception, while this field **sets** the bit to indicate that condition.

- **VMCS link pointer** (64 bits). If the "VMCS shadowing" VM-execution control is 1, the VMREAD and VMWRITE instructions access the VMCS referenced by this pointer (see Section 1.10). Otherwise, software should set this field to FFFFFFFF_FFFFFFFFH to avoid VM-entry failures (see Section 27.3.1.5).
- **VMX-preemption timer value** (32 bits). This field is supported only on processors that support the 1-setting of the "activate VMX-preemption timer" VM-execution control. This field contains the value that the VMX-preemption timer will use following the next VM entry with that setting. See Section 26.5.1 and Section 27.7.4.
- **Page-directory-pointer-table entries** (PDPTes; 64 bits each). These four (4) fields (PDPTE0, PDPTE1, PDPTE2, and PDPTE3) are supported only on processors that support the 1-setting of the "enable EPT" VM-execution control. They correspond to the PDPTes referenced by CR3 when PAE paging is in use (see Section 4.4 in the Intel® 64 and IA-32 Architectures Software Developer’s Manual, Volume 3A). They are used only if the "enable EPT" VM-execution control is 1.
- **Guest interrupt status** (16 bits). This field is supported only on processors that support the 1-setting of the "virtual-interrupt delivery" VM-execution control. It characterizes part of the guest’s virtual-APIC state and does not correspond to any processor or APIC registers. It comprises two 8-bit subfields:
 - **Requesting virtual interrupt (RVI)**. This is the low byte of the guest interrupt status. The processor treats this value as the vector of the highest priority virtual interrupt that is requesting service. (The value 0 implies that there is no such interrupt.)
 - **Servicing virtual interrupt (SVI)**. This is the high byte of the guest interrupt status. The processor treats this value as the vector of the highest priority virtual interrupt that is in service. (The value 0 implies that there is no such interrupt.)

See Chapter 30 for more information on the use of this field.
- **PML index** (16 bits). This field is supported only on processors that support the 1-setting of the "enable PML" VM-execution control. It contains the logical index of the next entry in the page-modification log. Because the page-modification log comprises 512 entries, the PML index is typically a value in the range 0–511. Details of the page-modification log and use of the PML index are given in Section 29.3.6.

25.5 HOST-STATE AREA

This section describes fields contained in the host-state area of the VMCS. As noted earlier, processor state is loaded from these fields on every VM exit (see Section 28.5).

All fields in the host-state area correspond to processor registers:

- CR0, CR3, and CR4 (64 bits each; 32 bits on processors that do not support Intel 64 architecture).
- RSP and RIP (64 bits each; 32 bits on processors that do not support Intel 64 architecture).
- Selector fields (16 bits each) for the segment registers CS, SS, DS, ES, FS, GS, and TR. There is no field in the host-state area for the LDTR selector.
- Base-address fields for FS, GS, TR, GDTR, and IDTR (64 bits each; 32 bits on processors that do not support Intel 64 architecture).
- The following MSRs:
 - IA32_SYSENTER_CS (32 bits)
 - IA32_SYSENTER_ESP and IA32_SYSENTER_EIP (64 bits; 32 bits on processors that do not support Intel 64 architecture).
 - IA32_PERF_GLOBAL_CTRL (64 bits). This field is supported only on processors that support the 1-setting of the “load IA32_PERF_GLOBAL_CTRL” VM-exit control.
 - IA32_PAT (64 bits). This field is supported only on processors that support the 1-setting of the “load IA32_PAT” VM-exit control.
 - IA32_EFER (64 bits). This field is supported only on processors that support the 1-setting of the “load IA32_EFER” VM-exit control.
 - IA32_S_CET (64 bits; 32 bits on processors that do not support Intel 64 architecture). This field is supported only on processors that support the 1-setting of the “load CET state” VM-exit control.
 - IA32_INTERRUPT_SSP_TABLE_ADDR (64 bits; 32 bits on processors that do not support Intel 64 architecture). This field is supported only on processors that support the 1-setting of the “load CET state” VM-exit control.
 - IA32_PKRS (64 bits). This field is supported only on processors that support the 1-setting of the “load PKRS” VM-exit control.
- The shadow-stack pointer register SSP (64 bits; 32 bits on processors that do not support Intel 64 architecture). This field is supported only on processors that support the 1-setting of the “load CET state” VM-exit control.

In addition to the state identified here, some processor state components are loaded with fixed values on every VM exit; there are no fields corresponding to these components in the host-state area. See Section 28.5 for details of how state is loaded on VM exits.

25.6 VM-EXECUTION CONTROL FIELDS

The VM-execution control fields govern VMX non-root operation. These are described in Section 1.6.1 through Section 1.6.8.

25.6.1 Pin-Based VM-Execution Controls

The pin-based VM-execution controls constitute a 32-bit vector that governs the handling of asynchronous events (for example: interrupts).¹ Table 1-5 lists the controls. See Chapter 28 for how these controls affect processor behavior in VMX non-root operation.

1. Some asynchronous events cause VM exits regardless of the settings of the pin-based VM-execution controls (see Section 26.2).

Table 25-5. Definitions of Pin-Based VM-Execution Controls

Bit Position(s)	Name	Description
0	External-interrupt exiting	If this control is 1, external interrupts cause VM exits. Otherwise, they are delivered normally through the guest interrupt-descriptor table (IDT). If this control is 1, the value of RFLAGS.IF does not affect interrupt blocking.
3	NMI exiting	If this control is 1, non-maskable interrupts (NMIs) cause VM exits. Otherwise, they are delivered normally using descriptor 2 of the IDT. This control also determines interactions between IRET and blocking by NMI (see Section 26.3).
5	Virtual NMIs	If this control is 1, NMIs are never blocked and the “blocking by NMI” bit (bit 3) in the interruptibility-state field indicates “virtual-NMI blocking” (see Table 1-3). This control also interacts with the “NMI-window exiting” VM-execution control (see Section 1.6.2).
6	Activate VMX-preemption timer	If this control is 1, the VMX-preemption timer counts down in VMX non-root operation; see Section 26.5.1. A VM exit occurs when the timer counts down to zero; see Section 26.2.
7	Process posted interrupts	If this control is 1, the processor treats interrupts with the posted-interrupt notification vector (see Section 1.6.8) specially, updating the virtual-APIC page with posted-interrupt requests (see Section 30.6).

All other bits in this field are reserved, some to 0 and some to 1. Software should consult the VMX capability MSRs IA32_VMX_PINBASED_CTLs and IA32_VMX_TRUE_PINBASED_CTLs (see Appendix A.3.1) to determine how to set reserved bits. Failure to set reserved bits properly causes subsequent VM entries to fail (see Section 27.2.1.1).

The first processors to support the virtual-machine extensions supported only the 1-settings of bits 1, 2, and 4. The VMX capability MSR IA32_VMX_PINBASED_CTLs will always report that these bits must be 1. Logical processors that support the 0-settings of any of these bits will support the VMX capability MSR IA32_VMX_TRUE_PINBASED_CTLs MSR, and software should consult this MSR to discover support for the 0-settings of these bits. Software that is not aware of the functionality of any one of these bits should set that bit to 1.

25.6.2 Processor-Based VM-Execution Controls

The processor-based VM-execution controls constitute three vectors that govern the handling of synchronous events, mainly those caused by the execution of specific instructions.¹ These are the **primary processor-based VM-execution controls** (32 bits), the **secondary processor-based VM-execution controls** (32 bits), and the tertiary **VM-execution controls** (64 bits).

Table 1-6 lists the primary processor-based VM-execution controls. See Chapter 26 for more details of how these controls affect processor behavior in VMX non-root operation.

Table 25-6. Definitions of Primary Processor-Based VM-Execution Controls

Bit Position(s)	Name	Description
2	Interrupt-window exiting	If this control is 1, a VM exit occurs at the beginning of any instruction if RFLAGS.IF = 1 and there are no other blocking of interrupts (see Section 1.4.2).
3	Use TSC offsetting	This control determines whether executions of RDTSC, executions of RDTSCP, and executions of RDMSR that read from the IA32_TIME_STAMP_COUNTER MSR return a value modified by the TSC offset field (see Section 1.6.5 and Section 26.3).
7	HLT exiting	This control determines whether executions of HLT cause VM exits.
9	INVLPG exiting	This determines whether executions of INVLPG cause VM exits.
10	MWAIT exiting	This control determines whether executions of MWAIT cause VM exits.
11	RDPMS exiting	This control determines whether executions of RDPMS cause VM exits.

1. Some instructions cause VM exits regardless of the settings of the processor-based VM-execution controls (see Section 26.1.2), as do task switches (see Section 26.2).

Table 25-6. Definitions of Primary Processor-Based VM-Execution Controls (Contd.)

Bit Position(s)	Name	Description
12	RDTSC exiting	This control determines whether executions of RDTSC and RDTSCP cause VM exits.
15	CR3-load exiting	In conjunction with the CR3-target controls (see Section 1.6.7), this control determines whether executions of MOV to CR3 cause VM exits. See Section 26.1.3. The first processors to support the virtual-machine extensions supported only the 1-setting of this control.
16	CR3-store exiting	This control determines whether executions of MOV from CR3 cause VM exits. The first processors to support the virtual-machine extensions supported only the 1-setting of this control.
17	Activate tertiary controls	This control determines whether the tertiary processor-based VM-execution controls are used. If this control is 0, the logical processor operates as if all the tertiary processor-based VM-execution controls were also 0.
19	CR8-load exiting	This control determines whether executions of MOV to CR8 cause VM exits.
20	CR8-store exiting	This control determines whether executions of MOV from CR8 cause VM exits.
21	Use TPR shadow	Setting this control to 1 enables TPR virtualization and other APIC-virtualization features. See Chapter 30.
22	NMI-window exiting	If this control is 1, a VM exit occurs at the beginning of any instruction if there is no virtual-NMI blocking (see Section 1.4.2).
23	MOV-DR exiting	This control determines whether executions of MOV DR cause VM exits.
24	Unconditional I/O exiting	This control determines whether executions of I/O instructions (IN, INS/INSB/INSW/INSD, OUT, and OUTS/OUTSB/OUTSW/OUTSD) cause VM exits.
25	Use I/O bitmaps	This control determines whether I/O bitmaps are used to restrict executions of I/O instructions (see Section 1.6.4 and Section 26.1.3). For this control, "0" means "do not use I/O bitmaps" and "1" means "use I/O bitmaps." If the I/O bitmaps are used, the setting of the "unconditional I/O exiting" control is ignored.
27	Monitor trap flag	If this control is 1, the monitor trap flag debugging feature is enabled. See Section 26.5.2.
28	Use MSR bitmaps	This control determines whether MSR bitmaps are used to control execution of the RDMSR and WRMSR instructions (see Section 1.6.9 and Section 26.1.3). For this control, "0" means "do not use MSR bitmaps" and "1" means "use MSR bitmaps." If the MSR bitmaps are not used, all executions of the RDMSR and WRMSR instructions cause VM exits.
29	MONITOR exiting	This control determines whether executions of MONITOR cause VM exits.
30	PAUSE exiting	This control determines whether executions of PAUSE cause VM exits.
31	Activate secondary controls	This control determines whether the secondary processor-based VM-execution controls are used. If this control is 0, the logical processor operates as if all the secondary processor-based VM-execution controls were also 0.

All other bits in this field are reserved, some to 0 and some to 1. Software should consult the VMX capability MSRs IA32_VMX_PROCBASED_CTLs and IA32_VMX_TRUE_PROCBASED_CTLs (see Appendix A.3.2) to determine how to set reserved bits. Failure to set reserved bits properly causes subsequent VM entries to fail (see Section 27.2.1.1).

The first processors to support the virtual-machine extensions supported only the 1-settings of bits 1, 4–6, 8, 13–16, and 26. The VMX capability MSR IA32_VMX_PROCBASED_CTLs will always report that these bits must be 1. Logical processors that support the 0-settings of any of these bits will support the VMX capability MSR IA32_VMX_TRUE_PROCBASED_CTLs MSR, and software should consult this MSR to discover support for the 0-settings of these bits. Software that is not aware of the functionality of any one of these bits should set that bit to 1.

Bit 31 of the primary processor-based VM-execution controls determines whether the secondary processor-based VM-execution controls are used. If that bit is 0, VM entry and VMX non-root operation function as if all the secondary processor-based VM-execution controls were 0. Processors that support only the 0-setting of bit 31 of

the primary processor-based VM-execution controls do not support the secondary processor-based VM-execution controls.

Table 1-7 lists the secondary processor-based VM-execution controls. See Chapter 26 for more details of how these controls affect processor behavior in VMX non-root operation.

Table 25-7. Definitions of Secondary Processor-Based VM-Execution Controls

Bit Position(s)	Name	Description
0	Virtualize APIC accesses	If this control is 1, the logical processor treats specially accesses to the page with the APIC-access address. See Section 30.4.
1	Enable EPT	If this control is 1, extended page tables (EPT) are enabled. See Section 29.3.
2	Descriptor-table exiting	This control determines whether executions of LGDT, LIDT, LLDT, LTR, SGDT, SIDT, SLDT, and STR cause VM exits.
3	Enable RDTSCP	If this control is 0, any execution of RDTSCP causes an invalid-opcode exception (#UD).
4	Virtualize x2APIC mode	If this control is 1, the logical processor treats specially RDMSR and WRMSR to APIC MSRs (in the range 800H-8FFH). See Section 30.5.
5	Enable VPID	If this control is 1, cached translations of linear addresses are associated with a virtual-processor identifier (VPID). See Section 29.1.
6	WBINVD exiting	This control determines whether executions of WBINVD and WBNOINVD cause VM exits.
7	Unrestricted guest	This control determines whether guest software may run in unpagged protected mode or in real-address mode.
8	APIC-register virtualization	If this control is 1, the logical processor virtualizes certain APIC accesses. See Section 30.4 and Section 30.5.
9	Virtual-interrupt delivery	This controls enables the evaluation and delivery of pending virtual interrupts as well as the emulation of writes to the APIC registers that control interrupt prioritization.
10	PAUSE-loop exiting	This control determines whether a series of executions of PAUSE can cause a VM exit (see Section 1.6.13 and Section 26.1.3).
11	RDRAND exiting	This control determines whether executions of RDRAND cause VM exits.
12	Enable INVPCID	If this control is 0, any execution of INVPCID causes a #UD.
13	Enable VM functions	Setting this control to 1 enables use of the VMFUNC instruction in VMX non-root operation. See Section 26.5.6.
14	VMCS shadowing	If this control is 1, executions of VMREAD and VMWRITE in VMX non-root operation may access a shadow VMCS (instead of causing VM exits). See Section 1.10 and Section 31.3.
15	Enable ENCLS exiting	If this control is 1, executions of ENCLS consult the ENCLS-exiting bitmap to determine whether the instruction causes a VM exit. See Section 1.6.16 and Section 26.1.3.
16	RDSEED exiting	This control determines whether executions of RDSEED cause VM exits.
17	Enable PML	If this control is 1, an access to a guest-physical address that sets an EPT dirty bit first adds an entry to the page-modification log. See Section 29.3.6.
18	EPT-violation #VE	If this control is 1, EPT violations may cause virtualization exceptions (#VE) instead of VM exits. See Section 26.5.7.
19	Conceal VMX from PT	If this control is 1, Intel Processor Trace suppresses from PIPs an indication that the processor was in VMX non-root operation and omits a VMCS packet from any PSB+ produced in VMX non-root operation (see Chapter 33).
20	Enable XSAVES/XRSTORS	If this control is 0, any execution of XSAVES or XRSTORS causes a #UD.
21	PASID translation	If this control is 1, PASID translation is performed for executions of ENQCMD and ENQCMDs. See Section 26.5.8.
22	Mode-based execute control for EPT	If this control is 1, EPT execute permissions are based on whether the linear address being accessed is supervisor mode or user mode. See Chapter 29.

Table 25-7. Definitions of Secondary Processor-Based VM-Execution Controls (Contd.)

Bit Position(s)	Name	Description
23	Sub-page write permissions for EPT	If this control is 1, EPT write permissions may be specified at the granularity of 128 bytes. See Section 29.3.4.
24	Intel PT uses guest physical addresses	If this control is 1, all output addresses used by Intel Processor Trace are treated as guest-physical addresses and translated using EPT. See Section 26.5.4.
25	Use TSC scaling	This control determines whether executions of RDTSC, executions of RDTSCP, and executions of RDMSR that read from the IA32_TIME_STAMP_COUNTER MSR return a value modified by the TSC multiplier field (see Section 1.6.5 and Section 26.3).
26	Enable user wait and pause	If this control is 0, any execution of TPAUSE, UMONITOR, or UMWAIT causes a #UD.
27	Enable PCONFIG	If this control is 0, any execution of PCONFIG causes a #UD.
28	Enable ENCLV exiting	If this control is 1, executions of ENCLV consult the ENCLV-exiting bitmap to determine whether the instruction causes a VM exit. See Section 1.6.17 and Section 26.1.3.
30	VMM bus-lock detection	This control determines whether assertion of a bus lock causes a VM exit. See Section 26.2.
31	Instruction timeout	If this control is 1, a VM exit occurs if certain operations prevent the processor from reaching an instruction boundary within a specified amount of time. See Section 1.6.25 and Section 26.2.

All other bits in this field are reserved to 0. Software should consult the VMX capability MSR IA32_VMX_PROCBASED_CTL2 (see Appendix A.3.3) to determine which bits may be set to 1. Failure to clear reserved bits causes subsequent VM entries to fail (see Section 27.2.1.1).

Bit 17 of the primary processor-based VM-execution controls determines whether the tertiary processor-based VM-execution controls are used. If that bit is 0, VM entry and VMX non-root operation function as if all the tertiary processor-based VM-execution controls were 0. Processors that support only the 0-setting of bit 17 of the primary processor-based VM-execution controls do not support the tertiary processor-based VM-execution controls.

Table 1-8 lists the tertiary processor-based VM-execution controls. See Chapter 26 for more details of how these controls affect processor behavior in VMX non-root operation.

Table 25-8. Definitions of Tertiary Processor-Based VM-Execution Controls

Bit Position(s)	Name	Description
0	LOADIWKEY exiting	This control determines whether executions of LOADIWKEY cause VM exits.
1	Enable HLAT	This control enables hypervisor-managed linear-address translation. See Section 4.5.1.
2	EPT paging-write control	If this control is 1, EPT permissions can be specified to allow writes only for paging-related updates. See Section 29.3.3.2.
3	Guest-paging verification	If this control is 1, EPT permissions can be specified to prevent accesses using linear addresses whose translation has certain properties. See Section 29.3.3.2.
4	IPI virtualization	If this control is 1, virtualization of interprocessor interrupts (IPIs) is enabled. See Section 30.1.6.
7	Virtualize IA32_SPEC_CTRL	If this control is 1, the operation of the RDMSR and WRMSR instructions is changed when accessing the IA32_SPEC_CTRL MSR. See Section 26.3.

All other bits in this field are reserved to 0. Software should consult the VMX capability MSR IA32_VMX_PROCBASED_CTL3 (see Appendix A.3.4) to determine which bits may be set to 1. Failure to clear reserved bits causes subsequent VM entries to fail (see Section 27.2.1.1).

25.6.3 Exception Bitmap

The **exception bitmap** is a 32-bit field that contains one bit for each exception. When an exception occurs, its vector is used to select a bit in this field. If the bit is 1, the exception causes a VM exit. If the bit is 0, the exception is delivered normally through the IDT, using the descriptor corresponding to the exception's vector.

Whether a page fault (exception with vector 14) causes a VM exit is determined by bit 14 in the exception bitmap as well as the error code produced by the page fault and two 32-bit fields in the VMCS (the **page-fault error-code mask** and **page-fault error-code match**). See Section 26.2 for details.

25.6.4 I/O-Bitmap Addresses

The VM-execution control fields include the 64-bit physical addresses of **I/O bitmaps** A and B (each of which are 4 KBytes in size). I/O bitmap A contains one bit for each I/O port in the range 0000H through 7FFFH; I/O bitmap B contains bits for ports in the range 8000H through FFFFH.

A logical processor uses these bitmaps if and only if the "use I/O bitmaps" control is 1. If the bitmaps are used, execution of an I/O instruction causes a VM exit if any bit in the I/O bitmaps corresponding to a port it accesses is 1. See Section 26.1.3 for details. If the bitmaps are used, their addresses must be 4-KByte aligned.

25.6.5 Time-Stamp Counter Offset and Multiplier

The VM-execution control fields include a 64-bit **TSC-offset** field. If the "RDTSC exiting" control is 0 and the "use TSC offsetting" control is 1, this field controls executions of the RDTSC and RDTSCP instructions. It also controls executions of the RDMSR instruction that read from the IA32_TIME_STAMP_COUNTER MSR. For all of these, the value of the TSC offset is added to the value of the time-stamp counter, and the sum is returned to guest software in EDX:EAX.

Processors that support the 1-setting of the "use TSC scaling" control also support a 64-bit **TSC-multiplier** field. If this control is 1 (and the "RDTSC exiting" control is 0 and the "use TSC offsetting" control is 1), this field also affects the executions of the RDTSC, RDTSCP, and RDMSR instructions identified above. Specifically, the contents of the time-stamp counter is first multiplied by the TSC multiplier before adding the TSC offset.

See Chapter 26 for a detailed treatment of the behavior of RDTSC, RDTSCP, and RDMSR in VMX non-root operation.

25.6.6 Guest/Host Masks and Read Shadows for CR0 and CR4

VM-execution control fields include **guest/host masks** and **read shadows** for the CR0 and CR4 registers. These fields control executions of instructions that access those registers (including CLTS, LMSW, MOV CR, and SMSW). They are 64 bits on processors that support Intel 64 architecture and 32 bits on processors that do not.

In general, bits set to 1 in a guest/host mask correspond to bits "owned" by the host:

- Guest attempts to set them (using CLTS, LMSW, or MOV to CR) to values differing from the corresponding bits in the corresponding read shadow cause VM exits.
- Guest reads (using MOV from CR or SMSW) return values for these bits from the corresponding read shadow.

Bits cleared to 0 correspond to bits "owned" by the guest; guest attempts to modify them succeed and guest reads return values for these bits from the control register itself.

See Chapter 28 for details regarding how these fields affect VMX non-root operation.

25.6.7 CR3-Target Controls

The VM-execution control fields include a set of 4 **CR3-target values** and a **CR3-target count**. The CR3-target values each have 64 bits on processors that support Intel 64 architecture and 32 bits on processors that do not. The CR3-target count has 32 bits on all processors.

An execution of MOV to CR3 in VMX non-root operation does not cause a VM exit if its source operand matches one of these values. If the CR3-target count is n , only the first n CR3-target values are considered; if the CR3-target count is 0, MOV to CR3 always causes a VM exit.

There are no limitations on the values that can be written for the CR3-target values. VM entry fails (see Section 27.2) if the CR3-target count is greater than 4.

Future processors may support a different number of CR3-target values. Software should read the VMX capability MSR IA32_VMX_MISC (see Appendix A.6) to determine the number of values supported.

25.6.8 Controls for APIC Virtualization

There are three mechanisms by which software accesses registers of the logical processor's local APIC:

- If the local APIC is in xAPIC mode, it can perform memory-mapped accesses to addresses in the 4-KByte page referenced by the physical address in the IA32_APIC_BASE MSR (see Section 11.4.4, "Local APIC Status and Location," in the Intel® 64 and IA-32 Architectures Software Developer's Manual, Volume 3A, and the Intel® 64 Architecture Processor Topology Enumeration Technical Paper).¹
- If the local APIC is in x2APIC mode, it can access the local APIC's registers using the RDMSR and WRMSR instructions (see the Intel® 64 Architecture Processor Topology Enumeration Technical Paper).
- In 64-bit mode, it can access the local APIC's task-priority register (TPR) using the MOV CR8 instruction.

Several processor-based VM-execution controls (see Section 1.6.2) control such accesses. These are "use TPR shadow", "virtualize APIC accesses", "virtualize x2APIC mode", "virtual-interrupt delivery", "APIC-register virtualization", and "IPI virtualization". These controls interact with the following fields:

- **APIC-access address** (64 bits). This field contains the physical address of the 4-KByte **APIC-access page**. If the "virtualize APIC accesses" VM-execution control is 1, access to this page may cause VM exits or be virtualized by the processor. See Section 30.4.

The APIC-access address exists only on processors that support the 1-setting of the "virtualize APIC accesses" VM-execution control.

- **Virtual-APIC address** (64 bits). This field contains the physical address of the 4-KByte **virtual-APIC page**. The processor uses the virtual-APIC page to virtualize certain accesses to APIC registers and to manage virtual interrupts; see Chapter 30.

Depending on the setting of the controls indicated earlier, the virtual-APIC page may be accessed by the following operations:

- The MOV CR8 instructions (see Section 30.3).
- Accesses to the APIC-access page if, in addition, the "virtualize APIC accesses" VM-execution control is 1 (see Section 30.4).
- The RDMSR and WRMSR instructions if, in addition, the value of ECX is in the range 800H–8FFH (indicating an APIC MSR) and the "virtualize x2APIC mode" VM-execution control is 1 (see Section 30.5).

If the "use TPR shadow" VM-execution control is 1, VM entry ensures that the virtual-APIC address is 4-KByte aligned. The virtual-APIC address exists only on processors that support the 1-setting of the "use TPR shadow" VM-execution control.

- **TPR threshold** (32 bits). Bits 3:0 of this field determine the threshold below which bits 7:4 of VTPR (see Section 30.1.1) cannot fall. If the "virtual-interrupt delivery" VM-execution control is 0, a VM exit occurs after an operation (e.g., an execution of MOV to CR8) that reduces the value of those bits below the TPR threshold. See Section 30.1.2.

The TPR threshold exists only on processors that support the 1-setting of the "use TPR shadow" VM-execution control.

- **EOI-exit bitmap** (4 fields; 64 bits each). These fields are supported only on processors that support the 1-setting of the "virtual-interrupt delivery" VM-execution control. They are used to determine which virtualized writes to the APIC's EOI register cause VM exits:

1. If the local APIC does not support x2APIC mode, it is always in xAPIC mode.

- EOI_EXIT0 contains bits for vectors from 0 (bit 0) to 63 (bit 63).
- EOI_EXIT1 contains bits for vectors from 64 (bit 0) to 127 (bit 63).
- EOI_EXIT2 contains bits for vectors from 128 (bit 0) to 191 (bit 63).
- EOI_EXIT3 contains bits for vectors from 192 (bit 0) to 255 (bit 63).

See Section 30.1.4 for more information on the use of this field.

- **Posted-interrupt notification vector** (16 bits). This field is supported only on processors that support the 1-setting of the “process posted interrupts” VM-execution control. Its low 8 bits contain the interrupt vector that is used to notify a logical processor that virtual interrupts have been posted. See Section 30.6 for more information on the use of this field.
- **Posted-interrupt descriptor address** (64 bits). This field is supported only on processors that support the 1-setting of the “process posted interrupts” VM-execution control. It is the physical address of a 64-byte aligned posted interrupt descriptor. See Section 30.6 for more information on the use of this field.
- **PID-pointer table address** (64 bits). This field contains the physical address of the **PID-pointer table**. If the “IPI virtualization” VM-execution control is 1, the logical processor uses entries in this table to virtualize IPIs. See Section 30.1.6.
- **Last PID-pointer index** (16 bits). This field contains the index of the last entry in the PID-pointer table.

25.6.9 MSR-Bitmap Address

On processors that support the 1-setting of the “use MSR bitmaps” VM-execution control, the VM-execution control fields include the 64-bit physical address of four contiguous **MSR bitmaps**, which are each 1-KByte in size. This field does not exist on processors that do not support the 1-setting of that control. The four bitmaps are:

- **Read bitmap for low MSRs** (located at the MSR-bitmap address). This contains one bit for each MSR address in the range 00000000H to 00001FFFH. The bit determines whether an execution of RDMSR applied to that MSR causes a VM exit.
- **Read bitmap for high MSRs** (located at the MSR-bitmap address plus 1024). This contains one bit for each MSR address in the range C0000000H to C0001FFFH. The bit determines whether an execution of RDMSR applied to that MSR causes a VM exit.
- **Write bitmap for low MSRs** (located at the MSR-bitmap address plus 2048). This contains one bit for each MSR address in the range 00000000H to 00001FFFH. The bit determines whether an execution of WRMSR applied to that MSR causes a VM exit.
- **Write bitmap for high MSRs** (located at the MSR-bitmap address plus 3072). This contains one bit for each MSR address in the range C0000000H to C0001FFFH. The bit determines whether an execution of WRMSR applied to that MSR causes a VM exit.

A logical processor uses these bitmaps if and only if the “use MSR bitmaps” control is 1. If the bitmaps are used, an execution of RDMSR or WRMSR causes a VM exit if the value of RCX is in neither of the ranges covered by the bitmaps or if the appropriate bit in the MSR bitmaps (corresponding to the instruction and the RCX value) is 1. See Section 26.1.3 for details. If the bitmaps are used, their address must be 4-KByte aligned.

25.6.10 Executive-VMCS Pointer

The executive-VMCS pointer is a 64-bit field used in the dual-monitor treatment of system-management interrupts (SMIs) and system-management mode (SMM). SMM VM exits save this field as described in Section 32.15.2. VM entries that return from SMM use this field as described in Section 32.15.4.

25.6.11 Extended-Page-Table Pointer (EPTP)

The **extended-page-table pointer** (EPTP) contains the address of the base of EPT PML4 table (see Section 29.3.2), as well as other EPT configuration information. The format of this field is shown in Table 1-9.

Table 25-9. Format of Extended-Page-Table Pointer

Bit Position(s)	Field
2:0	EPT paging-structure memory type (see Section 29.3.7): 0 = Uncacheable (UC) 6 = Write-back (WB) Other values are reserved. ¹
5:3	This value is 1 less than the EPT page-walk length (see Section 29.3.2)
6	Setting this control to 1 enables accessed and dirty flags for EPT (see Section 29.3.5) ²
7	Setting this control to 1 enables enforcement of access rights for supervisor shadow-stack pages (see Section 29.3.3.2) ³
11:8	Reserved
N-1:12	Bits N-1:12 of the physical address of the 4-KByte aligned EPT paging-structure (an EPT PML4 table with 4-level EPT and an EPT PML5 table with 5-level EPT) ⁴
63:N	Reserved

NOTES:

1. Software should read the VMX capability MSR IA32_VMX_EPT_VPID_CAP (see Appendix A.10) to determine what EPT paging-structure memory types are supported.
2. Not all processors support accessed and dirty flags for EPT. Software should read the VMX capability MSR IA32_VMX_EPT_VPID_CAP (see Appendix A.10) to determine whether the processor supports this feature.
3. Not all processors enforce access rights for shadow-stack pages. Software should read the VMX capability MSR IA32_VMX_EPT_VPID_CAP (see Appendix A.10) to determine whether the processor supports this feature.
4. N is the physical-address width supported by the logical processor. Software can determine a processor's physical-address width by executing CPUID with 80000008H in EAX. The physical-address width is returned in bits 7:0 of EAX.

The EPTP exists only on processors that support the 1-setting of the "enable EPT" VM-execution control.

25.6.12 Virtual-Processor Identifier (VPID)

The **virtual-processor identifier** (VPID) is a 16-bit field. It exists only on processors that support the 1-setting of the "enable VPID" VM-execution control. See Section 29.1 for details regarding the use of this field.

25.6.13 Controls for PAUSE-Loop Exiting

On processors that support the 1-setting of the "PAUSE-loop exiting" VM-execution control, the VM-execution control fields include the following 32-bit fields:

- **PLE_Gap.** Software can configure this field as an upper bound on the amount of time between two successive executions of PAUSE in a loop.
- **PLE_Window.** Software can configure this field as an upper bound on the amount of time a guest is allowed to execute in a PAUSE loop.

These fields measure time based on a counter that runs at the same rate as the timestamp counter (TSC). See Section 26.1.3 for more details regarding PAUSE-loop exiting.

25.6.14 VM-Function Controls

The **VM-function controls** constitute a 64-bit vector that governs use of the VMFUNC instruction in VMX non-root operation. This field is supported only on processors that support the 1-settings of both the “activate secondary controls” primary processor-based VM-execution control and the “enable VM functions” secondary processor-based VM-execution control.

Table 1-10 lists the VM-function controls. See Section 26.5.6 for more details of how these controls affect processor behavior in VMX non-root operation.

Table 25-10. Definitions of VM-Function Controls

Bit Position(s)	Name	Description
0	EPTP switching	The EPTP-switching VM function changes the EPT pointer to a value chosen from the EPTP list. See Section 26.5.6.3.

All other bits in this field are reserved to 0. Software should consult the VMX capability MSR IA32_VMX_VMFUNC (see Appendix A.11) to determine which bits are reserved. Failure to clear reserved bits causes subsequent VM entries to fail (see Section 27.2.1.1).

Processors that support the 1-setting of the “EPTP switching” VM-function control also support a 64-bit field called the **EPTP-list address**. This field contains the physical address of the 4-KByte **EPTP list**. The EPTP list comprises 512 8-Byte entries (each an EPTP value) and is used by the EPTP-switching VM function (see Section 26.5.6.3).

25.6.15 VMCS Shadowing Bitmap Addresses

On processors that support the 1-setting of the “VMCS shadowing” VM-execution control, the VM-execution control fields include the 64-bit physical addresses of the **VMREAD bitmap** and the **VMWRITE bitmap**. Each bitmap is 4 KBytes in size and thus contains 32 KBits. The addresses are the **VMREAD-bitmap address** and the **VMWRITE-bitmap address**.

If the “VMCS shadowing” VM-execution control is 1, executions of VMREAD and VMWRITE may consult these bitmaps (see Section 1.10 and Section 31.3).

25.6.16 ENCLS-Exiting Bitmap

The **ENCLS-exiting bitmap** is a 64-bit field. If the “enable ENCLS exiting” VM-execution control is 1, execution of ENCLS causes a VM exit if the bit in this field corresponding to the value of EAX is 1. If the bit is 0, the instruction executes normally. See Section 26.1.3 for more information.

25.6.17 ENCLV-Exiting Bitmap

The **ENCLV-exiting bitmap** is a 64-bit field. If the “enable ENCLV exiting” VM-execution control is 1, execution of ENCLV causes a VM exit if the bit in this field corresponding to the value of EAX is 1. If the bit is 0, the instruction executes normally. See Section 26.1.3 for more information.

25.6.18 PCONFIG-Exiting Bitmap

The **PCONFIG-exiting bitmap** is a 64-bit field. If the “enable PCONFIG” VM-execution control is 1, execution of PCONFIG causes a VM exit if the bit in this field corresponding to the value of EAX is 1. If the control is 0, any execution of PCONFIG causes a #UD. See Section 26.1.3 for more information.

25.6.19 Control Field for Page-Modification Logging

The **PML address** is a 64-bit field. It is the 4-KByte aligned address of the **page-modification log**. The page-modification log consists of 512 64-bit entries. It is used for the page-modification logging feature. Details of the page-modification logging are given in Section 29.3.6.

If the “enable PML” VM-execution control is 1, VM entry ensures that the PML address is 4-KByte aligned. The PML address exists only on processors that support the 1-setting of the “enable PML” VM-execution control.

25.6.20 Controls for Virtualization Exceptions

On processors that support the 1-setting of the “EPT-violation #VE” VM-execution control, the VM-execution control fields include the following:

- **Virtualization-exception information address** (64 bits). This field contains the physical address of the **virtualization-exception information area**. When a logical processor encounters a virtualization exception, it saves virtualization-exception information at the virtualization-exception information address; see Section 26.5.7.2.
- **EPTP index** (16 bits). When an EPT violation causes a virtualization exception, the processor writes the value of this field to the virtualization-exception information area. The EPTP-switching VM function updates this field (see Section 26.5.6.3).

25.6.21 XSS-Exiting Bitmap

On processors that support the 1-setting of the “enable XSAVES/XRSTORS” VM-execution control, the VM-execution control fields include a 64-bit **XSS-exiting bitmap**. If the “enable XSAVES/XRSTORS” VM-execution control is 1, executions of XSAVES and XRSTORS may consult this bitmap (see Section 26.1.3 and Section 26.3).

25.6.22 Sub-Page-Permission-Table Pointer (SPPTP)

If the sub-page write-permission feature of EPT is enabled, EPT write permissions may be determined at a 128-byte granularity (see Section 29.3.4). These permissions are determined using a hierarchy of sub-page-permission structures in memory.

The root of this hierarchy is referenced by a VM-execution control field called the **sub-page-permission-table pointer** (SPPTP). The SPPTP contains the address of the base of the root SPP table (see Section 29.3.4.2). The format of this field is shown in Table 1-9.

Table 25-11. Format of Sub-Page-Permission-Table Pointer

Bit Position(s)	Field
11:0	Reserved
N-1:12	Bits N-1:12 of the physical address of the 4-KByte aligned root SPP table
63:N ¹	Reserved

NOTES:

1. N is the processor’s physical-address width. Software can determine this width by executing CPUID with 80000008H in EAX. The physical-address width is returned in bits 7:0 of EAX.

The SPPTP exists only on processors that support the 1-setting of the “sub-page write permissions for EPT” VM-execution control.

25.6.23 Fields Related to Hypervisor-Managed Linear-Address Translation

Two fields are used when the “enable HLAT” VM-execution control is 1, enabling HLAT paging:

- The **hypervisor-managed linear-address translation pointer** (HLAT pointer or HLATP) is used by HLAT paging to locate and access the first paging structure used for linear-address translation (see Section 4.5). The format of this field is shown in Table 1-12.

Table 25-12. Format of Hypervisor-Managed Linear-Address Translation Pointer

Bit Position(s)	Field
2:0	Reserved
3 (PWT)	Page-level write-through; indirectly determines the memory type used to access the first HLAT paging structure during linear-address translation.
4 (PCD)	Page-level cache disable; indirectly determines the memory type used to access the first HLAT paging structure during linear-address translation.
11:5	Reserved
N-1:12	Guest-physical address (4KB-aligned) of the first HLAT paging structure during linear-address translation. ¹
63:N	Reserved

NOTES:

1. N is the physical-address width supported by the logical processor. Software can determine a processor’s physical-address width by executing CPUID with 80000008H in EAX. The physical-address width is returned in bits 7:0 of EAX.

- The HLAT prefix size. The value of this field determines which linear address are subject to HLAT paging. See Section 4.5.1.

These fields exist only on processors that support the 1-setting of the “enable HLAT” VM-execution control.

25.6.24 Fields Related to PASID Translation

Two 64-bit VM-execution control fields are used when the “PASID translation” VM-execution control is 1, enabling translation of PASIDs for executions of ENQCMD and ENQCMDS: the **low PASID directory address** and the **high PASID directory address**. These are the physical addresses of the low PASID directory and the high PASID directory, respectively. These fields exist only on processors that support the 1-setting of the “PASID translation” VM-execution control.

See Section 26.5.8 for information on the PASID-translation process for ENQCMD and ENQCMDS.

25.6.25 Instruction-Timeout Control

On processors that support the 1-setting of the “instruction timeout” VM-execution control, the VM-execution control fields include a 32-bit **instruction-timeout control**. The processor interprets the value of this field as an amount of time as measured in units of crystal clock cycles.¹ If the “instruction timeout” VM-execution control is 1, a VM exit occurs if certain operations prevent the processor from reaching an instruction boundary within this amount of time.

1. CPUID.15H:ECX enumerates the nominal frequency of the core crystal clock in Hz.

25.6.26 Fields Controlling Virtualization of the IA32_SPEC_CTRL MSR

On processors that support the 1-setting of the “virtualize IA32_SPEC_CTRL” VM-execution control, the VM-execution control fields include the following 64-bit fields:

- **IA32_SPEC_CTRL mask.** Setting a bit in this field prevents guest software from modifying the corresponding bit in the IA32_SPEC_CTRL MSR.
- **IA32_SPEC_CTRL shadow.** This field contains the value that guest software expects to be in the IA32_SPEC_CTRL MSR.

Section 26.3 discusses how these fields are used in VMX non-root operation.

25.7 VM-EXIT CONTROL FIELDS

The VM-exit control fields govern the behavior of VM exits. They are discussed in Section 1.7.1 and Section 1.7.2.

25.7.1 VM-Exit Controls

The VM-exit controls constitute two vectors that govern the basic operation of VM exits. These are the **primary VM-exit controls** (32 bits) and the **secondary VM-exits controls** (64 bits).

Table 1-13 lists the primary VM-exit controls. See Chapter 28 for complete details of how these controls affect VM exits.

Table 25-13. Definitions of Primary VM-Exit Controls

Bit Position(s)	Name	Description
2	Save debug controls	This control determines whether DR7 and the IA32_DEBUGCTL MSR are saved on VM exit. The first processors to support the virtual-machine extensions supported only the 1-setting of this control.
9	Host address-space size	On processors that support Intel 64 architecture, this control determines whether a logical processor is in 64-bit mode after the next VM exit. Its value is loaded into CS.L, IA32_EFER.LME, and IA32_EFER.LMA on every VM exit. ¹ This control must be 0 on processors that do not support Intel 64 architecture.
12	Load IA32_PERF_GLOBAL_CTRL	This control determines whether the IA32_PERF_GLOBAL_CTRL MSR is loaded on VM exit.
15	Acknowledge interrupt on exit	This control affects VM exits due to external interrupts: <ul style="list-style-type: none"> ▪ If such a VM exit occurs and this control is 1, the logical processor acknowledges the interrupt controller, acquiring the interrupt’s vector. The vector is stored in the VM-exit interruption-information field, which is marked valid. ▪ If such a VM exit occurs and this control is 0, the interrupt is not acknowledged and the VM-exit interruption-information field is marked invalid.
18	Save IA32_PAT	This control determines whether the IA32_PAT MSR is saved on VM exit.
19	Load IA32_PAT	This control determines whether the IA32_PAT MSR is loaded on VM exit.
20	Save IA32_EFER	This control determines whether the IA32_EFER MSR is saved on VM exit.
21	Load IA32_EFER	This control determines whether the IA32_EFER MSR is loaded on VM exit.
22	Save VMX-preemption timer value	This control determines whether the value of the VMX-preemption timer is saved on VM exit.
23	Clear IA32_BNDCFGS	This control determines whether the IA32_BNDCFGS MSR is cleared on VM exit.
24	Conceal VMX from PT	If this control is 1, Intel Processor Trace does not produce a paging information packet (PIP) on a VM exit or a VMCS packet on an SMM VM exit (see Chapter 33).
25	Clear IA32_RTIT_CTL	This control determines whether the IA32_RTIT_CTL MSR is cleared on VM exit.

Table 25-13. Definitions of Primary VM-Exit Controls (Contd.)

Bit Position(s)	Name	Description
26	Clear IA32_LBR_CTL	This control determines whether the IA32_LBR_CTL MSR is cleared on VM exit.
27	Clear UINV	This control determines whether UINV is cleared on VM exit.
28	Load CET state	This control determines whether CET-related MSRs and SSP are loaded on VM exit.
29	Load PKRS	This control determines whether the IA32_PKRS MSR is loaded on VM exit.
30	Save IA32_PERF_GLOBAL_CTL	This control determines whether the IA32_PERF_GLOBAL_CTL MSR is saved on VM exit.
31	Activate secondary controls	This control determines whether the secondary VM-exit controls are used. If this control is 0, the logical processor operates as if all the secondary VM-exit controls were also 0.

NOTES:

1. Since the Intel 64 architecture specifies that IA32_EFER.LMA is always set to the logical-AND of CRO.PG and IA32_EFER.LME, and since CRO.PG is always 1 in VMX root operation, IA32_EFER.LMA is always identical to IA32_EFER.LME in VMX root operation.

All other bits in this field are reserved, some to 0 and some to 1. Software should consult the VMX capability MSRs IA32_VMX_EXIT_CTLS and IA32_VMX_TRUE_EXIT_CTLS (see Appendix A.4) to determine how it should set the reserved bits. Failure to set reserved bits properly causes subsequent VM entries to fail (see Section 27.2.1.2).

The first processors to support the virtual-machine extensions supported only the 1-settings of bits 0–8, 10, 11, 13, 14, 16, and 17. The VMX capability MSR IA32_VMX_EXIT_CTLS always reports that these bits must be 1. Logical processors that support the 0-settings of any of these bits will support the VMX capability MSR IA32_VMX_TRUE_EXIT_CTLS MSR, and software should consult this MSR to discover support for the 0-settings of these bits. Software that is not aware of the functionality of any one of these bits should set that bit to 1.

Bit 31 of the primary processor-based VM-exit controls determines whether the secondary VM-exit controls are used. If that bit is 0, VM entries and VM exits function as if all the secondary VM-exit controls were 0. Processors that support only the 0-setting of bit 31 of the primary VM-exit controls do not support the secondary VM-exit controls.

Table 1-14 lists the secondary VM-exit controls. See Chapter 28 for more details of how these controls affect VM exits.

Table 25-14. Definitions of Secondary VM-Exit Controls

Bit Position(s)	Name	Description
3	Prematurely busy shadow stack	If this control is 1, VM exits that cause a shadow stack to become prematurely busy (see Section 17.2.3, “Supervisor Shadow Stack Token,” in the Intel® 64 and IA-32 Architectures Software Developer’s Manual, Volume 1) indicate this fact and save additional information into the VMCS.

All other bits in this field are reserved to 0. Software should consult the VMX capability MSR IA32_VMX_EXIT_CTLS2 (see Appendix A.4.2) to determine which bits may be set to 1. Failure to clear reserved bits causes subsequent VM entries to fail (see Section 27.2.1.2).

25.7.2 VM-Exit Controls for MSRs

A VMM may specify lists of MSRs to be stored and loaded on VM exits. The following VM-exit control fields determine how MSRs are stored on VM exits:

- **VM-exit MSR-store count** (32 bits). This field specifies the number of MSRs to be stored on VM exit. It is recommended that this count not exceed 512.¹ Otherwise, unpredictable processor behavior (including a machine check) may result during VM exit.
- **VM-exit MSR-store address** (64 bits). This field contains the physical address of the VM-exit MSR-store area. The area is a table of entries, 16 bytes per entry, where the number of entries is given by the VM-exit MSR-store count. The format of each entry is given in Table 1-15. If the VM-exit MSR-store count is not zero, the address must be 16-byte aligned.

Table 25-15. Format of an MSR Entry

Bit Position(s)	Contents
31:0	MSR index
63:32	Reserved
127:64	MSR data

See Section 28.4 for how this area is used on VM exits.

The following VM-exit control fields determine how MSRs are loaded on VM exits:

- **VM-exit MSR-load count** (32 bits). This field contains the number of MSRs to be loaded on VM exit. It is recommended that this count not exceed 512. Otherwise, unpredictable processor behavior (including a machine check) may result during VM exit.²
- **VM-exit MSR-load address** (64 bits). This field contains the physical address of the VM-exit MSR-load area. The area is a table of entries, 16 bytes per entry, where the number of entries is given by the VM-exit MSR-load count (see Table 1-15). If the VM-exit MSR-load count is not zero, the address must be 16-byte aligned.

See Section 28.6 for how this area is used on VM exits.

25.8 VM-ENTRY CONTROL FIELDS

The VM-entry control fields govern the behavior of VM entries. They are discussed in Sections 1.8.1 through 1.8.3.

25.8.1 VM-Entry Controls

The **VM-entry controls** constitute a 32-bit vector that governs the basic operation of VM entries. Table 1-16 lists the controls supported. See Chapter 1 for how these controls affect VM entries.

Table 25-16. Definitions of VM-Entry Controls

Bit Position(s)	Name	Description
2	Load debug controls	This control determines whether DR7 and the IA32_DEBUGCTL MSR are loaded on VM entry. The first processors to support the virtual-machine extensions supported only the 1-setting of this control.
9	IA-32e mode guest	On processors that support Intel 64 architecture, this control determines whether the logical processor is in IA-32e mode after VM entry. Its value is loaded into IA32_EFER.LMA as part of VM entry. ¹ This control must be 0 on processors that do not support Intel 64 architecture.
10	Entry to SMM	This control determines whether the logical processor is in system-management mode (SMM) after VM entry. This control must be 0 for any VM entry from outside SMM.

1. Future implementations may allow more MSRs to be stored reliably. Software should consult the VMX capability MSR IA32_VMX_MISC to determine the number supported (see Appendix A.6).

2. Future implementations may allow more MSRs to be loaded reliably. Software should consult the VMX capability MSR IA32_VMX_MISC to determine the number supported (see Appendix A.6).

Table 25-16. Definitions of VM-Entry Controls (Contd.)

Bit Position(s)	Name	Description
11	Deactivate dual-monitor treatment	If set to 1, the default treatment of SMIs and SMM is in effect after the VM entry (see Section 32.15.7). This control must be 0 for any VM entry from outside SMM.
13	Load IA32_PERF_GLOBAL_CTRL	This control determines whether the IA32_PERF_GLOBAL_CTRL MSR is loaded on VM entry.
14	Load IA32_PAT	This control determines whether the IA32_PAT MSR is loaded on VM entry.
15	Load IA32_EFER	This control determines whether the IA32_EFER MSR is loaded on VM entry.
16	Load IA32_BNDCFGS	This control determines whether the IA32_BNDCFGS MSR is loaded on VM entry.
17	Conceal VMX from PT	If this control is 1, Intel Processor Trace does not produce a paging information packet (PIP) on a VM entry or a VMCS packet on a VM entry that returns from SMM (see Chapter 33).
18	Load IA32_RTIT_CTL	This control determines whether the IA32_RTIT_CTL MSR is loaded on VM entry.
19	Load UINV	This control determines whether UINV is loaded on VM entry.
20	Load CET state	This control determines whether CET-related MSRs and SSP are loaded on VM entry.
21	Load guest IA32_LBR_CTL	This control determines whether the IA32_LBR_CTL MSR is loaded on VM entry.
22	Load PKRS	This control determines whether the IA32_PKRS MSR is loaded on VM entry.

NOTES:

1. Bit 5 of the IA32_VMX_MISC MSR is read as 1 on any logical processor that supports the 1-setting of the “unrestricted guest” VM-execution control. If it is read as 1, every VM exit stores the value of IA32_EFER.LMA into the “IA-32e mode guest” VM-entry control (see Section 28.2).

All other bits in this field are reserved, some to 0 and some to 1. Software should consult the VMX capability MSRs IA32_VMX_ENTRY_CTLS and IA32_VMX_TRUE_ENTRY_CTLS (see Appendix A.5) to determine how it should set the reserved bits. Failure to set reserved bits properly causes subsequent VM entries to fail (see Section 27.2.1.3).

The first processors to support the virtual-machine extensions supported only the 1-settings of bits 0–8 and 12. The VMX capability MSR IA32_VMX_ENTRY_CTLS always reports that these bits must be 1. Logical processors that support the 0-settings of any of these bits will support the VMX capability MSR IA32_VMX_TRUE_ENTRY_CTLS MSR, and software should consult this MSR to discover support for the 0-settings of these bits. Software that is not aware of the functionality of any one of these bits should set that bit to 1.

25.8.2 VM-Entry Controls for MSRs

A VMM may specify a list of MSRs to be loaded on VM entries. The following VM-entry control fields manage this functionality:

- **VM-entry MSR-load count** (32 bits). This field contains the number of MSRs to be loaded on VM entry. It is recommended that this count not exceed 512. Otherwise, unpredictable processor behavior (including a machine check) may result during VM entry.¹
- **VM-entry MSR-load address** (64 bits). This field contains the physical address of the VM-entry MSR-load area. The area is a table of entries, 16 bytes per entry, where the number of entries is given by the VM-entry MSR-load count. The format of entries is described in Table 1-15. If the VM-entry MSR-load count is not zero, the address must be 16-byte aligned.

See Section 27.4 for details of how this area is used on VM entries.

1. Future implementations may allow more MSRs to be loaded reliably. Software should consult the VMX capability MSR IA32_VMX_MISC to determine the number supported (see Appendix A.6).

25.8.3 VM-Entry Controls for Event Injection

VM entry can be configured to conclude by delivering an event through the IDT (after all guest state and MSRs have been loaded). This process is called **event injection** and is controlled by the following three VM-entry control fields:

- **VM-entry interruption-information field** (32 bits). This field provides details about the event to be injected. Table 1-17 describes the field.

Table 25-17. Format of the VM-Entry Interruption-Information Field

Bit Position(s)	Content
7:0	Vector of interrupt or exception
10:8	Interruption type: 0: External interrupt 1: Reserved 2: Non-maskable interrupt (NMI) 3: Hardware exception (e.g., #PF) 4: Software interrupt (INT <i>n</i>) 5: Privileged software exception (INT1) 6: Software exception (INT3 or INTO) 7: Other event
11	Deliver error code (0 = do not deliver; 1 = deliver)
30:12	Reserved
31	Valid

- The **vector** (bits 7:0) determines which entry in the IDT is used or which other event is injected.
- The **interruption type** (bits 10:8) determines details of how the injection is performed. In general, a VMM should use the type hardware exception for all exceptions **other than** the following:
 - breakpoint exceptions (#BP; a VMM should use the type software exception);
 - overflow exceptions (#OF a VMM should use the use type software exception); and
 - those debug exceptions (#DB) that are generated by INT1 (a VMM should use the use type privileged software exception).¹

The type **other event** is used for injection of events that are not delivered through the IDT.²
- For exceptions, the **deliver-error-code bit** (bit 11) determines whether delivery pushes an error code on the guest stack.
- VM entry injects an event if and only if the **valid bit** (bit 31) is 1. The valid bit in this field is cleared on every VM exit (see Section 28.2).
- **VM-entry exception error code** (32 bits). This field is used if and only if the valid bit (bit 31) and the deliver-error-code bit (bit 11) are both set in the VM-entry interruption-information field.
- **VM-entry instruction length** (32 bits). For injection of events whose type is software interrupt, software exception, or privileged software exception, this field is used to determine the value of RIP that is pushed on the stack.

See Section 27.6 for details regarding the mechanics of event injection, including the use of the interruption type and the VM-entry instruction length.

VM exits clear the valid bit (bit 31) in the VM-entry interruption-information field.

1. The type hardware exception should be used for all other debug exceptions.

2. INT1 and INT3 refer to the instructions with opcodes F1 and CC, respectively, and not to INT *n* with values 1 or 3 for *n*.

25.9 VM-EXIT INFORMATION FIELDS

The VMCS contains a section of fields that contain information about the most recent VM exit.

On some processors, attempts to write to these fields with VMWRITE fail (see “VMWRITE—Write Field to Virtual-Machine Control Structure” in Chapter 31).¹

25.9.1 Basic VM-Exit Information

The following VM-exit information fields provide basic information about a VM exit:

- **Exit reason** (32 bits). This field encodes the reason for the VM exit and has the structure given in Table 1-18.

Table 25-18. Format of Exit Reason

Bit Position(s)	Contents
15:0	Basic exit reason
16	Always cleared to 0
26:17	Not currently defined
27	A VM exit saves this bit as 1 to indicate that the VM exit was incident to enclave mode.
28	Pending MTF VM exit
29	VM exit from VMX root operation
30	Not currently defined
31	VM-entry failure (0 = true VM exit; 1 = VM-entry failure)

- Bits 15:0 provide basic information about the cause of the VM exit (if bit 31 is clear) or of the VM-entry failure (if bit 31 is set). Appendix C enumerates the basic exit reasons.
- Bit 16 is always cleared to 0.
- Bit 27 is set to 1 if the VM exit occurred while the logical processor was in enclave mode.
A VM exit also sets this bit if it is incident to delivery of an event injected by VM entry and the guest interruptibility-state field indicates an enclave interrupt (bit 4 of the field is 1). See Section 28.2.1 for details.
- Bit 28 is set only by an SMM VM exit (see Section 32.15.2) that took priority over an MTF VM exit (see Section 26.5.2) that would have occurred had the SMM VM exit not occurred. See Section 32.15.2.3.
- Bit 29 is set if and only if the processor was in VMX root operation at the time the VM exit occurred. This can happen only for SMM VM exits. See Section 32.15.2.
- Because some VM-entry failures load processor state from the host-state area (see Section 27.8), software must be able to distinguish such cases from true VM exits. Bit 31 is used for that purpose.
- **Exit qualification** (64 bits; 32 bits on processors that do not support Intel 64 architecture). This field contains additional information about the cause of VM exits due to the following: debug exceptions; page-fault exceptions; start-up IPIs (SIPIs); task switches; INVEPT; INVLPG; INVVPID; LGDT; LIDT; LLDT; LTR; SGDT; SIDT; SLDT; STR; VMCLEAR; VMPTRLD; VMPTRST; VMREAD; VMWRITE; VMXON; XRSTORS; XSAVES; control-register accesses; MOV DR; I/O instructions; and MWAIT. The format of the field depends on the cause of the VM exit. See Section 28.2.1 for details.
- **Guest-linear address** (64 bits; 32 bits on processors that do not support Intel 64 architecture). This field is used in the following cases:
 - VM exits due to attempts to execute LMSW with a memory operand.

1. Software can discover whether these fields can be written by reading the VMX capability MSR IA32_VMX_MISC (see Appendix A.6).

- VM exits due to attempts to execute INS or OUTS.
- VM exits due to system-management interrupts (SMIs) that arrive immediately after retirement of I/O instructions.
- Certain VM exits due to EPT violations

See Section 28.2.1 and Section 32.15.2.3 for details of when and how this field is used.

- **Guest-physical address** (64 bits). This field is used by VM exits due to EPT violations and EPT misconfigurations. See Section 28.2.1 for details of when and how this field is used.

25.9.2 Information for VM Exits Due to Vectored Events

Event-specific information is provided for VM exits due to the following vectored events: exceptions (including those generated by the instructions INT3, INTO, INT1, BOUND, UD0, UD1, and UD2); external interrupts that occur while the “acknowledge interrupt on exit” VM-exit control is 1; and non-maskable interrupts (NMIs). This information is provided in the following fields:

- **VM-exit interruption information** (32 bits). This field receives basic information associated with the event causing the VM exit. Table 1-19 describes this field.

Table 25-19. Format of the VM-Exit Interruption-Information Field

Bit Position(s)	Content
7:0	Vector of interrupt or exception
10:8	Interruption type: 0: External interrupt 1: Not used 2: Non-maskable interrupt (NMI) 3: Hardware exception 4: Not used 5: Privileged software exception 6: Software exception 7: Not used
11	Error code valid (0 = invalid; 1 = valid)
12	NMI unblocking due to IRET
30:13	Not currently defined
31	Valid

- **VM-exit interruption error code** (32 bits). For VM exits caused by hardware exceptions that would have delivered an error code on the stack, this field receives that error code.

Section 28.2.2 provides details of how these fields are saved on VM exits.

25.9.3 Information for VM Exits That Occur During Event Delivery

Additional information is provided for VM exits that occur during event delivery in VMX non-root operation.¹ This information is provided in the following fields:

1. This includes cases in which the event delivery was caused by event injection as part of VM entry; see Section 27.6.1.2.

- **IDT-vectoring information** (32 bits). This field receives basic information associated with the event that was being delivered when the VM exit occurred. Table 1-20 describes this field.

Table 25-20. Format of the IDT-Vectoring Information Field

Bit Position(s)	Content
7:0	Vector of interrupt or exception
10:8	Interruption type: 0: External interrupt 1: Not used 2: Non-maskable interrupt (NMI) 3: Hardware exception 4: Software interrupt 5: Privileged software exception 6: Software exception 7: Not used
11	Error code valid (0 = invalid; 1 = valid)
30:12	Not currently defined
31	Valid

- **IDT-vectoring error code** (32 bits). For VM exits that occur during delivery of hardware exceptions that would have delivered an error code on the stack, this field receives that error code.

See Section 28.2.4 provides details of how these fields are saved on VM exits.

25.9.4 Information for VM Exits Due to Instruction Execution

The following fields are used for VM exits caused by attempts to execute certain instructions in VMX non-root operation:

- **VM-exit instruction length** (32 bits). For VM exits resulting from instruction execution, this field receives the length in bytes of the instruction whose execution led to the VM exit.¹ See Section 28.2.5 for details of when and how this field is used.
- **VM-exit instruction information** (32 bits). This field is used for VM exits due to attempts to execute `INS`, `INVEPT`, `INVVPID`, `LIDT`, `LGDT`, `LLDT`, `LTR`, `OUTS`, `SIDT`, `SGDT`, `SLDT`, `STR`, `VMCLEAR`, `VMPTRLD`, `VMPTRST`, `VMREAD`, `VMWRITE`, or `VMXON`.² The format of the field depends on the cause of the VM exit. See Section 28.2.5 for details.

The following fields (64 bits each; 32 bits on processors that do not support Intel 64 architecture) are used only for VM exits due to SMIs that arrive immediately after retirement of I/O instructions. They provide information about that I/O instruction:

- **I/O RCX**. The value of RCX before the I/O instruction started.
- **I/O RSI**. The value of RSI before the I/O instruction started.
- **I/O RDI**. The value of RDI before the I/O instruction started.
- **I/O RIP**. The value of RIP before the I/O instruction started (the RIP that addressed the I/O instruction).

1. This field is also used for VM exits that occur during the delivery of a software interrupt or software exception.

2. Whether the processor provides this information on VM exits due to attempts to execute `INS` or `OUTS` can be determined by consulting the VMX capability MSR `IA32_VMX_BASIC` (see Appendix A.1).

25.9.5 VM-Instruction Error Field

The 32-bit **VM-instruction error field** does not provide information about the most recent VM exit. In fact, it is not modified on VM exits. Instead, it provides information about errors encountered by a non-faulting execution of one of the VMX instructions.

25.10 VMCS TYPES: ORDINARY AND SHADOW

Every VMCS is either an **ordinary VMCS** or a **shadow VMCS**. A VMCS's type is determined by the shadow-VMCS indicator in the VMCS region (this is the value of bit 31 of the first 4 bytes of the VMCS region; see Table 1-1): 0 indicates an ordinary VMCS, while 1 indicates a shadow VMCS. Shadow VMCSs are supported only on processors that support the 1-setting of the "VMCS shadowing" VM-execution control (see Section 1.6.2).

A shadow VMCS differs from an ordinary VMCS in two ways:

- An ordinary VMCS can be used for VM entry but a shadow VMCS cannot. Attempts to perform VM entry when the current VMCS is a shadow VMCS fail (see Section 27.1).
- The VMREAD and VMWRITE instructions can be used in VMX non-root operation to access a shadow VMCS but not an ordinary VMCS. This fact results from the following:
 - If the "VMCS shadowing" VM-execution control is 0, execution of the VMREAD and VMWRITE instructions in VMX non-root operation always cause VM exits (see Section 26.1.3).
 - If the "VMCS shadowing" VM-execution control is 1, execution of the VMREAD and VMWRITE instructions in VMX non-root operation can access the VMCS referenced by the VMCS link pointer (see Section 31.3).
 - If the "VMCS shadowing" VM-execution control is 1, VM entry ensures that any VMCS referenced by the VMCS link pointer is a shadow VMCS (see Section 27.3.1.5).

In VMX root operation, both types of VMCSs can be accessed with the VMREAD and VMWRITE instructions.

Software should not modify the shadow-VMCS indicator in the VMCS region of a VMCS that is active. Doing so may cause the VMCS to become corrupted (see Section 1.11.1). Before modifying the shadow-VMCS indicator, software should execute VMCLEAR for the VMCS to ensure that it is not active.

25.11 SOFTWARE USE OF THE VMCS AND RELATED STRUCTURES

This section details guidelines that software should observe when using a VMCS and related structures. It also provides descriptions of consequences for failing to follow guidelines.

25.11.1 Software Use of Virtual-Machine Control Structures

To ensure proper processor behavior, software should observe certain guidelines when using an active VMCS.

No VMCS should ever be active on more than one logical processor. If a VMCS is to be "migrated" from one logical processor to another, the first logical processor should execute VMCLEAR for the VMCS (to make it inactive on that logical processor and to ensure that all VMCS data are in memory) before the other logical processor executes VMPTRLD for the VMCS (to make it active on the second logical processor).¹ A VMCS that is made active on more than one logical processor may become **corrupted** (see below).

Software should not modify the shadow-VMCS indicator (see Table 1-1) in the VMCS region of a VMCS that is active. Doing so may cause the VMCS to become corrupted. Before modifying the shadow-VMCS indicator, software should execute VMCLEAR for the VMCS to ensure that it is not active.

Software should use the VMREAD and VMWRITE instructions to access the different fields in the current VMCS (see Section 1.11.2). Software should never access or modify the VMCS data of an active VMCS using ordinary memory

1. As noted in Section 1.1, execution of the VMPTRLD instruction makes a VMCS active. In addition, VM entry makes active any shadow VMCS referenced by the VMCS link pointer in the current VMCS. If a shadow VMCS is made active by VM entry, it is necessary to execute VMCLEAR for that VMCS before allowing that VMCS to become active on another logical processor.

operations, in part because the format used to store the VMCS data is implementation-specific and not architecturally defined, and also because a logical processor may maintain some VMCS data of an active VMCS on the processor and not in the VMCS region. The following items detail some of the hazards of accessing VMCS data using ordinary memory operations:

- Any data read from a VMCS with an ordinary memory read does not reliably reflect the state of the VMCS. Results may vary from time to time or from logical processor to logical processor.
- Writing to a VMCS with an ordinary memory write is not guaranteed to have a deterministic effect on the VMCS. Doing so may cause the VMCS to become corrupted (see below).

(Software can avoid these hazards by removing any linear-address mappings to a VMCS region before executing a VMPTRLD for that region and by not remapping it until after executing VMCLEAR for that region.)

If a logical processor leaves VMX operation, any VMCSs active on that logical processor may be corrupted (see below). To prevent such corruption of a VMCS that may be used either after a return to VMX operation or on another logical processor, software should execute VMCLEAR for that VMCS before executing the VMXOFF instruction or removing power from the processor (e.g., as part of a transition to the S3 and S4 power states).

This section has identified operations that may cause a VMCS to become corrupted. These operations may cause the VMCS's data to become undefined. Behavior may be unpredictable if that VMCS used subsequently on any logical processor. The following items detail some hazards of VMCS corruption:

- VM entries may fail for unexplained reasons or may load undesired processor state.
- The processor may not correctly support VMX non-root operation as documented in Chapter 26 and may generate unexpected VM exits.
- VM exits may load undesired processor state, save incorrect state into the VMCS, or cause the logical processor to transition to a shutdown state.

25.11.2 VMREAD, VMWRITE, and Encodings of VMCS Fields

Every field of the VMCS is associated with a 32-bit value that is its **encoding**. The encoding is provided in an operand to VMREAD and VMWRITE when software wishes to read or write that field. These instructions fail if given, in 64-bit mode, an operand that sets an encoding bit beyond bit 32. See Chapter 31 for a description of these instructions.

The structure of the 32-bit encodings of the VMCS components is determined principally by the width of the fields and their function in the VMCS. See Table 1-21.

Table 25-21. Structure of VMCS Component Encoding

Bit Position(s)	Contents
0	Access type (0 = full; 1 = high); must be full for 16-bit, 32-bit, and natural-width fields
9:1	Index
11:10	Type: 0: control 1: VM-exit information 2: guest state 3: host state
12	Reserved (must be 0)
14:13	Width: 0: 16-bit 1: 64-bit 2: 32-bit 3: natural-width
31:15	Reserved (must be 0)

The following items detail the meaning of the bits in each encoding:

- **Field width.** Bits 14:13 encode the width of the field.
 - A value of 0 indicates a 16-bit field.
 - A value of 1 indicates a 64-bit field.
 - A value of 2 indicates a 32-bit field.
 - A value of 3 indicates a **natural-width** field. Such fields have 64 bits on processors that support Intel 64 architecture and 32 bits on processors that do not.

Fields whose encodings use value 1 are specially treated to allow 32-bit software access to all 64 bits of the field. Such access is allowed by defining, for each such field, an encoding that allows direct access to the high 32 bits of the field. See below.
- **Field type.** Bits 11:10 encode the type of VMCS field: control, guest-state, host-state, or VM-exit information. (The last category also includes the VM-instruction error field.)
- **Index.** Bits 9:1 distinguish components with the same field width and type.
- **Access type.** Bit 0 must be 0 for all fields except for 64-bit fields (those with field-width 1; see above). A VMREAD or VMWRITE using an encoding with this bit cleared to 0 accesses the entire field. For a 64-bit field with field-width 1, a VMREAD or VMWRITE using an encoding with this bit set to 1 accesses only the high 32 bits of the field.

Appendix B gives the encodings of all fields in the VMCS.

The following describes the operation of VMREAD and VMWRITE based on processor mode, VMCS-field width, and access type:

- 16-bit fields:
 - A VMREAD returns the value of the field in bits 15:0 of the destination operand; other bits of the destination operand are cleared to 0.
 - A VMWRITE writes the value of bits 15:0 of the source operand into the VMCS field; other bits of the source operand are not used.
- 32-bit fields:
 - A VMREAD returns the value of the field in bits 31:0 of the destination operand; in 64-bit mode, bits 63:32 of the destination operand are cleared to 0.
 - A VMWRITE writes the value of bits 31:0 of the source operand into the VMCS field; in 64-bit mode, bits 63:32 of the source operand are not used.
- 64-bit fields and natural-width fields using the full access type outside IA-32e mode.
 - A VMREAD returns the value of bits 31:0 of the field in its destination operand; bits 63:32 of the field are ignored.
 - A VMWRITE writes the value of its source operand to bits 31:0 of the field and clears bits 63:32 of the field.
- 64-bit fields and natural-width fields using the full access type in 64-bit mode (only on processors that support Intel 64 architecture).
 - A VMREAD returns the value of the field in bits 63:0 of the destination operand
 - A VMWRITE writes the value of bits 63:0 of the source operand into the VMCS field.
- 64-bit fields using the high access type.
 - A VMREAD returns the value of bits 63:32 of the field in bits 31:0 of the destination operand; in 64-bit mode, bits 63:32 of the destination operand are cleared to 0.
 - A VMWRITE writes the value of bits 31:0 of the source operand to bits 63:32 of the field; in 64-bit mode, bits 63:32 of the source operand are not used.

Software seeking to read a 64-bit field outside IA-32e mode can use VMREAD with the full access type (reading bits 31:0 of the field) and VMREAD with the high access type (reading bits 63:32 of the field); the order of the two VMREAD executions is not important. Software seeking to modify a 64-bit field outside IA-32e mode should first

use VMWRITE with the full access type (establishing bits 31:0 of the field while clearing bits 63:32) and then use VMWRITE with the high access type (establishing bits 63:32 of the field).

25.11.3 Initializing a VMCS

Software should initialize fields in a VMCS (using VMWRITE) before using the VMCS for VM entry. Failure to do so may result in unpredictable behavior; for example, a VM entry may fail for unexplained reasons, or a successful transition (VM entry or VM exit) may load processor state with unexpected values.

It is not necessary to initialize fields that the logical processor will not use. (For example, it is not necessary to initialize the MSR-bitmap address if the “use MSR bitmaps” VM-execution control is 0.)

A processor maintains some VMCS information that cannot be modified with the VMWRITE instruction; this includes a VMCS’s launch state (see Section 1.1). Such information may be stored in the VMCS data portion of a VMCS region. Because the format of this information is implementation-specific, there is no way for software to know, when it first allocates a region of memory for use as a VMCS region, how the processor will determine this information from the contents of the memory region.

In addition to its other functions, the VMCLEAR instruction initializes any implementation-specific information in the VMCS region referenced by its operand. To avoid the uncertainties of implementation-specific behavior, software should execute VMCLEAR on a VMCS region before making the corresponding VMCS active with VMPTRLD for the first time. (Figure 1-1 illustrates how execution of VMCLEAR puts a VMCS into a well-defined state.)

The following software usage is consistent with these limitations:

- VMCLEAR should be executed for a VMCS before it is used for VM entry for the first time.
- VMLAUNCH should be used for the first VM entry using a VMCS after VMCLEAR has been executed for that VMCS.
- VMRESUME should be used for any subsequent VM entry using a VMCS (until the next execution of VMCLEAR for the VMCS).

It is expected that, in general, VMRESUME will have lower latency than VMLAUNCH. Since “migrating” a VMCS from one logical processor to another requires use of VMCLEAR (see Section 1.11.1), which sets the launch state of the VMCS to “clear”, such migration requires the next VM entry to be performed using VMLAUNCH. Software developers can avoid the performance cost of increased VM-entry latency by avoiding unnecessary migration of a VMCS from one logical processor to another.

25.11.4 Software Access to Related Structures

In addition to data in the VMCS region itself, VMX non-root operation can be controlled by data structures that are referenced by pointers in a VMCS (for example, the I/O bitmaps). While the pointers to these data structures are parts of the VMCS, the data structures themselves are not. They are not accessible using VMREAD and VMWRITE but by ordinary memory writes.

Software should ensure that each such data structure is modified only when no logical processor with a current VMCS that references it is in VMX non-root operation. Doing otherwise may lead to unpredictable behavior (including behaviors identified in Section 1.11.1). Exceptions are made for the following data structures (subject to detailed discussion in the sections indicated): EPT paging structures and the data structures used to locate SPP vectors (Section 29.4.3); the virtual-APIC page (Section 30.1); the posted interrupt descriptor (Section 30.6); and the virtualization-exception information area (Section 26.5.7.2).

25.11.5 VMXON Region

Before executing VMXON, software allocates a region of memory (called the VMXON region)¹ that the logical processor uses to support VMX operation. The physical address of this region (the VMXON pointer) is provided in an operand to VMXON. The VMXON pointer is subject to the limitations that apply to VMCS pointers:

1. The amount of memory required for the VMXON region is the same as that required for a VMCS region. This size is implementation specific and can be determined by consulting the VMX capability MSR IA32_VMX_BASIC (see Appendix A.1).

- The VMXON pointer must be 4-KByte aligned (bits 11:0 must be zero).
- The VMXON pointer must not set any bits beyond the processor's physical-address width.^{1,2}

Before executing VMXON, software should write the VMCS revision identifier (see Section 1.2) to the VMXON region. (Specifically, it should write the 31-bit VMCS revision identifier to bits 30:0 of the first 4 bytes of the VMXON region; bit 31 should be cleared to 0.) It need not initialize the VMXON region in any other way. Software should use a separate region for each logical processor and should not access or modify the VMXON region of a logical processor between execution of VMXON and VMXOFF on that logical processor. Doing otherwise may lead to unpredictable behavior (including behaviors identified in Section 1.11.1).

-
1. Software can determine a processor's physical-address width by executing CPUID with 80000008H in EAX. The physical-address width is returned in bits 7:0 of EAX.
 2. If IA32_VMX_BASIC[48] is read as 1, the VMXON pointer must not set any bits in the range 63:32; see Appendix A.1.

In a virtualized environment using VMX, the guest software stack typically runs on a logical processor in VMX non-root operation. This mode of operation is similar to that of ordinary processor operation outside of the virtualized environment. This chapter describes the differences between VMX non-root operation and ordinary processor operation with special attention to causes of VM exits (which bring a logical processor from VMX non-root operation to root operation). The differences between VMX non-root operation and ordinary processor operation are described in the following sections:

- Section 26.1, “Instructions That Cause VM Exits.”
- Section 26.2, “Other Causes of VM Exits.”
- Section 26.3, “Changes to Instruction Behavior in VMX Non-Root Operation.”
- Section 26.4, “Other Changes in VMX Non-Root Operation.”
- Section 26.5, “Features Specific to VMX Non-Root Operation.”
- Section 26.6, “Unrestricted Guests.”

Chapter 27, “VM Entries,” describes the data control structures that govern VMX non-root operation. Chapter 27, “VM Entries,” describes the operation of VM entries by which the processor transitions from VMX root operation to VMX non-root operation. Chapter 26, “VMX Non-Root Operation,” describes the operation of VM exits by which the processor transitions from VMX non-root operation to VMX root operation.

Chapter 29, “VMX Support for Address Translation,” describes two features that support address translation in VMX non-root operation. Chapter 30, “APIC Virtualization and Virtual Interrupts,” describes features that support virtualization of interrupts and the Advanced Programmable Interrupt Controller (APIC) in VMX non-root operation.

26.1 INSTRUCTIONS THAT CAUSE VM EXITS

Certain instructions may cause VM exits if executed in VMX non-root operation. Unless otherwise specified, such VM exits are “fault-like,” meaning that the instruction causing the VM exit does not execute and no processor state is updated by the instruction. Section 28.1 details architectural state in the context of a VM exit.

Section 26.1.1 defines the prioritization between faults and VM exits for instructions subject to both. Section 26.1.2 identifies instructions that cause VM exits whenever they are executed in VMX non-root operation (and thus can never be executed in VMX non-root operation). Section 26.1.3 identifies instructions that cause VM exits depending on the settings of certain VM-execution control fields (see Section 25.6).

26.1.1 Relative Priority of Faults and VM Exits

The following principles describe the ordering between existing faults and VM exits:

- Certain exceptions have priority over VM exits. These include invalid-opcode exceptions, faults based on privilege level,¹ and general-protection exceptions that are based on checking I/O permission bits in the task-state segment (TSS). For example, execution of RDMSR with CPL = 3 generates a general-protection exception and not a VM exit.²
- Faults incurred while fetching instruction operands have priority over VM exits that are conditioned based on the contents of those operands (see LMSW in Section 26.1.3).
- VM exits caused by execution of the INS and OUTS instructions (resulting either because the “unconditional I/O exiting” VM-execution control is 1 or because the “use I/O bitmaps control is 1”) have priority over the following faults:

1. These include faults generated by attempts to execute, in virtual-8086 mode, privileged instructions that are not recognized in that mode.

2. MOV DR is an exception to this rule; see Section 26.1.3.

- A general-protection fault due to the relevant segment (ES for INS; DS for OUTS unless overridden by an instruction prefix) being unusable
- A general-protection fault due to an offset beyond the limit of the relevant segment
- An alignment-check exception
- Fault-like VM exits have priority over exceptions other than those mentioned above. For example, RDMSR of a non-existent MSR with CPL = 0 generates a VM exit and not a general-protection exception.

When Section 26.1.2 or Section 26.1.3 (below) identify an instruction execution that may lead to a VM exit, it is assumed that the instruction does not incur a fault that takes priority over a VM exit.

26.1.2 Instructions That Cause VM Exits Unconditionally

The following instructions cause VM exits when they are executed in VMX non-root operation: CPUID, GETSEC,¹ INVDP, and XSETBV. This is also true of instructions introduced with VMX, which include: INVEPT, INVVPID, VMCALL,² VMCLEAR, VMLAUNCH, VMPTRLD, VMPTRST, VMRESUME, VMXOFF, and VMXON.

26.1.3 Instructions That Cause VM Exits Conditionally

Certain instructions cause VM exits in VMX non-root operation depending on the setting of the VM-execution controls. The following instructions can cause “fault-like” VM exits based on the conditions described:³

- **CLTS.** The CLTS instruction causes a VM exit if the bits in position 3 (corresponding to CR0.TS) are set in both the CR0 guest/host mask and the CR0 read shadow.
- **ENCLS.** The ENCLS instruction causes a VM exit if the “enable ENCLS exiting” VM-execution control is 1 and one of the following is true:
 - The value of EAX is less than 63 and the corresponding bit in the ENCLS-exiting bitmap is 1 (see Section 25.6.16).
 - The value of EAX is greater than or equal to 63 and bit 63 in the ENCLS-exiting bitmap is 1.
- **ENCLV.** The ENCLV instruction causes a VM exit if the “enable ENCLV exiting” VM-execution control is 1 and one of the following is true:
 - The value of EAX is less than 63 and the corresponding bit in the ENCLV-exiting bitmap is 1 (see Section 25.6.17).
 - The value of EAX is greater than or equal to 63 and bit 63 in the ENCLV-exiting bitmap is 1.
- **ENQCMD, ENQCMDs.** The behavior of each of these instructions is determined by the setting of the “PASID translation” VM-execution control. If that control is 0, the instruction executes normally. If the control is 1, instruction behavior is modified and may cause a VM exit. See Section 26.5.8.
- **HLT.** The HLT instruction causes a VM exit if the “HLT exiting” VM-execution control is 1.
- **IN, INS/INSB/INSW/INSD, OUT, OUTS/OUTSB/OUTSW/OUTSD.** The behavior of each of these instructions is determined by the settings of the “unconditional I/O exiting” and “use I/O bitmaps” VM-execution controls:
 - If both controls are 0, the instruction executes normally.

1. An execution of GETSEC in VMX non-root operation causes a VM exit if CR4.SMXE[Bit 14] = 1 regardless of the value of CPL or RAX. An execution of GETSEC causes an invalid-opcode exception (#UD) if CR4.SMXE[Bit 14] = 0.

2. Under the dual-monitor treatment of SMIs and SMM, executions of VMCALL cause SMM VM exits in VMX root operation outside SMM. See Section 32.15.2.

3. Items in this section may refer to secondary processor-based VM-execution controls and tertiary processor-based VM-execution controls. If bit 31 of the primary processor-based VM-execution controls is 0, VMX non-root operation functions as if the secondary processor-based VM-execution controls were all 0; similarly, if bit 17 of the primary processor-based VM-execution controls is 0, VMX non-root operation functions as if the tertiary processor-based VM-execution controls were all 0. See Section 25.6.2.

- If the “unconditional I/O exiting” VM-execution control is 1 and the “use I/O bitmaps” VM-execution control is 0, the instruction causes a VM exit.
- If the “use I/O bitmaps” VM-execution control is 1, the instruction causes a VM exit if it attempts to access an I/O port corresponding to a bit set to 1 in the appropriate I/O bitmap (see Section 25.6.4). If an I/O operation “wraps around” the 16-bit I/O-port space (accesses ports FFFFH and 0000H), the I/O instruction causes a VM exit (the “unconditional I/O exiting” VM-execution control is ignored if the “use I/O bitmaps” VM-execution control is 1).

See Section 26.1.1 for information regarding the priority of VM exits relative to faults that may be caused by the INS and OUTS instructions.

- **INVLPG.** The INVLPG instruction causes a VM exit if the “INVLPG exiting” VM-execution control is 1.
- **INVPCID.** The INVPCID instruction causes a VM exit if the “INVLPG exiting” and “enable INVPCID” VM-execution controls are both 1.
- **LGDT, LIDT, LLDT, LTR, SGDT, SIDT, SLDT, STR.** These instructions cause VM exits if the “descriptor-table exiting” VM-execution control is 1.
- **LMSW.** In general, the LMSW instruction causes a VM exit if it would write, for any bit set in the low 4 bits of the CR0 guest/host mask, a value different than the corresponding bit in the CR0 read shadow. LMSW never clears bit 0 of CR0 (CR0.PE); thus, LMSW causes a VM exit if either of the following are true:
 - The bits in position 0 (corresponding to CR0.PE) are set in both the CR0 guest/host mask and the source operand, and the bit in position 0 is clear in the CR0 read shadow.
 - For any bit position in the range 3:1, the bit in that position is set in the CR0 guest/host mask and the values of the corresponding bits in the source operand and the CR0 read shadow differ.
- **LOADIWKEY.** The LOADIWKEY instruction causes a VM exit if the “LOADIWKEY exiting” VM-execution control is 1.
- **MONITOR.** The MONITOR instruction causes a VM exit if the “MONITOR exiting” VM-execution control is 1.
- **MOV from CR3.** The MOV from CR3 instruction causes a VM exit if the “CR3-store exiting” VM-execution control is 1. The first processors to support the virtual-machine extensions supported only the 1-setting of this control.
- **MOV from CR8.** The MOV from CR8 instruction causes a VM exit if the “CR8-store exiting” VM-execution control is 1.
- **MOV to CR0.** The MOV to CR0 instruction causes a VM exit unless the value of its source operand matches, for the position of each bit set in the CR0 guest/host mask, the corresponding bit in the CR0 read shadow. (If every bit is clear in the CR0 guest/host mask, MOV to CR0 cannot cause a VM exit.)
- **MOV to CR3.** The MOV to CR3 instruction causes a VM exit unless the “CR3-load exiting” VM-execution control is 0 or the value of its source operand is equal to one of the CR3-target values specified in the VMCS. Only the first n CR3-target values are considered, where n is the CR3-target count. If the “CR3-load exiting” VM-execution control is 1 and the CR3-target count is 0, MOV to CR3 always causes a VM exit.

The first processors to support the virtual-machine extensions supported only the 1-setting of the “CR3-load exiting” VM-execution control. These processors always consult the CR3-target controls to determine whether an execution of MOV to CR3 causes a VM exit.

- **MOV to CR4.** The MOV to CR4 instruction causes a VM exit unless the value of its source operand matches, for the position of each bit set in the CR4 guest/host mask, the corresponding bit in the CR4 read shadow.
- **MOV to CR8.** The MOV to CR8 instruction causes a VM exit if the “CR8-load exiting” VM-execution control is 1.
- **MOV DR.** The MOV DR instruction causes a VM exit if the “MOV-DR exiting” VM-execution control is 1. Such VM exits represent an exception to the principles identified in Section 26.1.1 in that they take priority over the following: general-protection exceptions based on privilege level; and invalid-opcode exceptions that occur because CR4.DE=1 and the instruction specified access to DR4 or DR5.
- **MWAIT.** The MWAIT instruction causes a VM exit if the “MWAIT exiting” VM-execution control is 1. If this control is 0, the behavior of the MWAIT instruction may be modified (see Section 26.3).
- **PAUSE.** The behavior of each of this instruction depends on CPL and the settings of the “PAUSE exiting” and “PAUSE-loop exiting” VM-execution controls:
 - CPL = 0.

- If the “PAUSE exiting” and “PAUSE-loop exiting” VM-execution controls are both 0, the PAUSE instruction executes normally.
- If the “PAUSE exiting” VM-execution control is 1, the PAUSE instruction causes a VM exit (the “PAUSE-loop exiting” VM-execution control is ignored if CPL = 0 and the “PAUSE exiting” VM-execution control is 1).
- If the “PAUSE exiting” VM-execution control is 0 and the “PAUSE-loop exiting” VM-execution control is 1, the following treatment applies.

The processor determines the amount of time between this execution of PAUSE and the previous execution of PAUSE at CPL 0. If this amount of time exceeds the value of the VM-execution control field PLE_Gap, the processor considers this execution to be the first execution of PAUSE in a loop. (It also does so for the first execution of PAUSE at CPL 0 after VM entry.)

Otherwise, the processor determines the amount of time since the most recent execution of PAUSE that was considered to be the first in a loop. If this amount of time exceeds the value of the VM-execution control field PLE_Window, a VM exit occurs.

For purposes of these computations, time is measured based on a counter that runs at the same rate as the timestamp counter (TSC).

— CPL > 0.

- If the “PAUSE exiting” VM-execution control is 0, the PAUSE instruction executes normally.
- If the “PAUSE exiting” VM-execution control is 1, the PAUSE instruction causes a VM exit.

The “PAUSE-loop exiting” VM-execution control is ignored if CPL > 0.

- **PCONFIG.** The PCONFIG instruction causes a VM exit if the “enable PCONFIG” VM-execution control is 1 and one of the following is true:

- The value of EAX is less than 63 and the corresponding bit in the PCONFIG-exiting bitmap is 1 (see Section 25.6.18).
- The value of EAX is greater than or equal to 63 and bit 63 in the PCONFIG-exiting bitmap is 1.

If the “enable PCONFIG” VM-execution control is 1 and neither of the previous items hold, the PCONFIG instruction executes normally.

- **RDMSR.** The RDMSR instruction causes a VM exit if any of the following are true:
 - The “use MSR bitmaps” VM-execution control is 0.
 - The value of ECX is not in the ranges 00000000H – 00001FFFH and C0000000H – C0001FFFH.
 - The value of ECX is in the range 00000000H – 00001FFFH and bit *n* in read bitmap for low MSRs is 1, where *n* is the value of ECX.
 - The value of ECX is in the range C0000000H – C0001FFFH and bit *n* in read bitmap for high MSRs is 1, where *n* is the value of ECX & 00001FFFH.

See Section 25.6.9 for details regarding how these bitmaps are identified.

- **RDPMC.** The RDPMC instruction causes a VM exit if the “RDPMC exiting” VM-execution control is 1.
- **RDRAND.** The RDRAND instruction causes a VM exit if the “RDRAND exiting” VM-execution control is 1.
- **RDSEED.** The RDSEED instruction causes a VM exit if the “RDSEED exiting” VM-execution control is 1.
- **RDTSC.** The RDTSC instruction causes a VM exit if the “RDTSC exiting” VM-execution control is 1.
- **RDTSCP.** The RDTSCP instruction causes a VM exit if the “RDTSC exiting” and “enable RDTSCP” VM-execution controls are both 1.
- **RSM.** The RSM instruction causes a VM exit if executed in system-management mode (SMM).¹
- **TPAUSE.** The TPAUSE instruction causes a VM exit if the “RDTSC exiting” and “enable user wait and pause” VM-execution controls are both 1.

1. Execution of the RSM instruction outside SMM causes an invalid-opcode exception regardless of whether the processor is in VMX operation. It also does so in VMX root operation in SMM; see Section 32.15.3.

- **UMWAIT.** The UMWAIT instruction causes a VM exit if the “RDTSC exiting” and “enable user wait and pause” VM-execution controls are both 1.
- **VMREAD.** The VMREAD instruction causes a VM exit if any of the following are true:
 - The “VMCS shadowing” VM-execution control is 0.
 - Bits 63:15 (bits 31:15 outside 64-bit mode) of the register source operand are not all 0.
 - Bit n in VMREAD bitmap is 1, where n is the value of bits 14:0 of the register source operand. See Section 25.6.15 for details regarding how the VMREAD bitmap is identified.

If the VMREAD instruction does not cause a VM exit, it reads from the VMCS referenced by the VMCS link pointer. See Chapter 31, “VMREAD—Read Field from Virtual-Machine Control Structure” for details of the operation of the VMREAD instruction.

- **VMWRITE.** The VMWRITE instruction causes a VM exit if any of the following are true:
 - The “VMCS shadowing” VM-execution control is 0.
 - Bits 63:15 (bits 31:15 outside 64-bit mode) of the register source operand are not all 0.
 - Bit n in VMWRITE bitmap is 1, where n is the value of bits 14:0 of the register source operand. See Section 25.6.15 for details regarding how the VMWRITE bitmap is identified.

If the VMWRITE instruction does not cause a VM exit, it writes to the VMCS referenced by the VMCS link pointer. See Chapter 31, “VMWRITE—Write Field to Virtual-Machine Control Structure” for details of the operation of the VMWRITE instruction.

- **WBINVD.** The WBINVD instruction causes a VM exit if the “WBINVD exiting” VM-execution control is 1.
- **WBNOINVD.** The WBNOINVD instruction causes a VM exit if the “WBINVD exiting” VM-execution control is 1.
- **WRMSR.** The WRMSR instruction causes a VM exit if any of the following are true:
 - The “use MSR bitmaps” VM-execution control is 0.
 - The value of ECX is not in the ranges 00000000H – 00001FFFH and C0000000H – C0001FFFH.
 - The value of ECX is in the range 00000000H – 00001FFFH and bit n in write bitmap for low MSRs is 1, where n is the value of ECX.
 - The value of ECX is in the range C0000000H – C0001FFFH and bit n in write bitmap for high MSRs is 1, where n is the value of ECX & 00001FFFH.

See Section 25.6.9 for details regarding how these bitmaps are identified.

- **XRSTORS.** The XRSTORS instruction causes a VM exit if the “enable XSAVES/XRSTORS” VM-execution control is 1 and any bit is set in the logical-AND of the following three values: EDX:EAX, the IA32_XSS MSR, and the XSS-exiting bitmap (see Section 25.6.21).
- **XSAVES.** The XSAVES instruction causes a VM exit if the “enable XSAVES/XRSTORS” VM-execution control is 1 and any bit is set in the logical-AND of the following three values: EDX:EAX, the IA32_XSS MSR, and the XSS-exiting bitmap (see Section 25.6.21).

26.2 OTHER CAUSES OF VM EXITS

In addition to VM exits caused by instruction execution, the following events can cause VM exits:¹

- **Exceptions.** Exceptions (faults, traps, and aborts) cause VM exits based on the exception bitmap (see Section 25.6.3). If an exception occurs, its vector (in the range 0–31) is used to select a bit in the exception bitmap. If the bit is 1, a VM exit occurs; if the bit is 0, the exception is delivered normally through the guest IDT. This use of the exception bitmap applies also to exceptions generated by the instructions INT1, INT3, INTO, BOUND, UD0, UD1, and UD2.²

1. Items in this section may refer to secondary processor-based VM-execution controls and tertiary processor-based VM-execution controls. If bit 31 of the primary processor-based VM-execution controls is 0, VMX non-root operation functions as if the secondary processor-based VM-execution controls were all 0; similarly, if bit 17 of the primary processor-based VM-execution controls is 0, VMX non-root operation functions as if the tertiary processor-based VM-execution controls were all 0. See Section 25.6.2.

Page faults (exceptions with vector 14) are specially treated. When a page fault occurs, a processor consults (1) bit 14 of the exception bitmap; (2) the error code produced with the page fault [PFEC]; (3) the page-fault error-code mask field [PFEC_MASK]; and (4) the page-fault error-code match field [PFEC_MATCH]. It checks if $PFEC \& PFEC_MASK = PFEC_MATCH$. If there is equality, the specification of bit 14 in the exception bitmap is followed (for example, a VM exit occurs if that bit is set). If there is inequality, the meaning of that bit is reversed (for example, a VM exit occurs if that bit is clear).

Thus, if software desires VM exits on all page faults, it can set bit 14 in the exception bitmap to 1 and set the page-fault error-code mask and match fields each to 00000000H. If software desires VM exits on no page faults, it can set bit 14 in the exception bitmap to 1, the page-fault error-code mask field to 00000000H, and the page-fault error-code match field to FFFFFFFFH.

- **Triple fault.** A VM exit occurs if the logical processor encounters an exception while attempting to call the double-fault handler and that exception itself does not cause a VM exit due to the exception bitmap. This applies to the case in which the double-fault exception was generated within VMX non-root operation, the case in which the double-fault exception was generated during event injection by VM entry, and to the case in which VM entry is injecting a double-fault exception.
- **External interrupts.** An external interrupt causes a VM exit if the “external-interrupt exiting” VM-execution control is 1. (See Section 26.6 for an exception.) Otherwise, the processor handles the interrupt normally.¹ (If a logical processor is in the shutdown state or the wait-for-SIPI state, external interrupts are blocked. The processor does handle the interrupt and no VM exit occurs.)
- **Non-maskable interrupts (NMIs).** An NMI causes a VM exit if the “NMI exiting” VM-execution control is 1. Otherwise, it is delivered using descriptor 2 of the IDT. (If a logical processor is in the wait-for-SIPI state, NMIs are blocked. The NMI is not delivered through the IDT and no VM exit occurs.)
- **INIT signals.** INIT signals cause VM exits. A logical processor performs none of the operations normally associated with these events. Such exits do not modify register state or clear pending events as they would outside of VMX operation. (If a logical processor is in the wait-for-SIPI state, INIT signals are blocked. They do not cause VM exits in this case.)
- **Start-up IPIs (SIPIs). SIPIs cause VM exits.** If a logical processor is not in the wait-for-SIPI activity state when a SIPI arrives, no VM exit occurs and the SIPI is discarded. VM exits due to SIPIs do not perform any of the normal operations associated with those events: they do not modify register state as they would outside of VMX operation. (If a logical processor is not in the wait-for-SIPI state, SIPIs are blocked. They do not cause VM exits in this case.)
- **Task switches.** Task switches are not allowed in VMX non-root operation. Any attempt to effect a task switch in VMX non-root operation causes a VM exit. See Section 26.4.2.
- **System-management interrupts (SMIs).** If the logical processor is using the dual-monitor treatment of SMIs and system-management mode (SMM), SMIs cause SMM VM exits. See Section 32.15.2.²
- **VMX-preemption timer.** A VM exit occurs when the timer counts down to zero. See Section 26.5.1 for details of operation of the VMX-preemption timer.

Debug-trap exceptions and higher priority events take priority over VM exits caused by the VMX-preemption timer. VM exits caused by the VMX-preemption timer take priority over VM exits caused by the “NMI-window exiting” VM-execution control and lower priority events.

These VM exits wake a logical processor from the same inactive states as would a non-maskable interrupt. Specifically, they wake a logical processor from the shutdown state and from the states entered using the HLT and MWAIT instructions. These VM exits do not occur if the logical processor is in the wait-for-SIPI state.

- **Bus locks.** Assertion of a bus lock (see Section 9.1.2) causes a VM exit if the “VMM bus-lock detection” VM-execution control is 1. Such a VM exit is trap-like because it is generated after execution of an instruction that asserts a bus lock. The VM exit thus does not prevent assertion of the bus lock. These VM exits take priority over system-management interrupts (SMIs), INIT signals, and lower priority events.

2. INT1 and INT3 refer to the instructions with opcodes F1 and CC, respectively, and not to INT *n* with value 1 or 3 for *n*.

1. Normal handling usually means delivery through the IDT, but it could also mean treatment of the interrupt as a user-interrupt notification.

2. Under the dual-monitor treatment of SMIs and SMM, SMIs also cause SMM VM exits if they occur in VMX root operation outside SMM. If the processor is using the default treatment of SMIs and SMM, SMIs are delivered as described in Section 32.14.1.

- **Instruction timeout.** If the “instruction timeout” VM-execution control is 1, a VM exit occurs if certain operations prevent the processor from reaching an instruction boundary within the amount of time specified by the instruction-timeout control VM-execution control field (see Section 25.6.25).

In addition, there are controls that cause VM exits based on the readiness of guest software to receive interrupts:

- If the “interrupt-window exiting” VM-execution control is 1, a VM exit occurs before execution of any instruction if RFLAGS.IF = 1 and there is no blocking of events by STI or by MOV SS (see Table 25-3). Such a VM exit occurs immediately after VM entry if the above conditions are true (see Section 27.7.5).

Non-maskable interrupts (NMIs) and higher priority events take priority over VM exits caused by this control. VM exits caused by this control take priority over external interrupts and lower priority events.

These VM exits wake a logical processor from the same inactive states as would an external interrupt. Specifically, they wake a logical processor from the states entered using the HLT and MWAIT instructions. These VM exits do not occur if the logical processor is in the shutdown state or the wait-for-SIPI state.

- If the “NMI-window exiting” VM-execution control is 1, a VM exit occurs before execution of any instruction if there is no virtual-NMI blocking and there is no blocking of events by MOV SS and no blocking of events by STI (see Table 25-3). Such a VM exit occurs immediately after VM entry if the above conditions are true (see Section 27.7.6).

VM exits caused by the VMX-preemption timer and higher priority events take priority over VM exits caused by this control. VM exits caused by this control take priority over non-maskable interrupts (NMIs) and lower priority events.

These VM exits wake a logical processor from the same inactive states as would an NMI. Specifically, they wake a logical processor from the shutdown state and from the states entered using the HLT and MWAIT instructions. These VM exits do not occur if the logical processor is in the wait-for-SIPI state.

26.3 CHANGES TO INSTRUCTION BEHAVIOR IN VMX NON-ROOT OPERATION

The behavior of some instructions is changed in VMX non-root operation. Some of these changes are determined by the settings of certain VM-execution control fields. The following items detail such changes:¹

- **CLTS.** Behavior of the CLTS instruction is determined by the bits in position 3 (corresponding to CR0.TS) in the CR0 guest/host mask and the CR0 read shadow:
 - If bit 3 in the CR0 guest/host mask is 0, CLTS clears CR0.TS normally (the value of bit 3 in the CR0 read shadow is irrelevant in this case), unless CR0.TS is fixed to 1 in VMX operation (see Section 24.8), in which case CLTS causes a general-protection exception.
 - If bit 3 in the CR0 guest/host mask is 1 and bit 3 in the CR0 read shadow is 0, CLTS completes but does not change the contents of CR0.TS.
 - If the bits in position 3 in the CR0 guest/host mask and the CR0 read shadow are both 1, CLTS causes a VM exit.
- **ENQCMD, ENQCMS.** Each of these instructions performs a 64-byte enqueue store that includes a PASID value in bits 19:0. For ENQCMD, the PASID is normally the value of IA32_PASID[19:0], while for ENQCMS, the PASID is normally read from memory.

The behavior of each of these instructions (and in particular the PASID value used for the enqueue store) is determined by the setting of the “PASID translation” VM-execution control:

- If the “PASID translation” VM-execution control is 0, the instruction operates normally.
- If the “PASID translation” VM-execution control is 1, the PASID value used for the enqueue store is determined by the PASID-translation process described in Section 26.5.8. (Note the PASID translation may result in a VM exit, in which case the enqueue store is not performed.)

1. Items in this section may refer to secondary processor-based VM-execution controls and tertiary processor-based VM-execution controls. If bit 31 of the primary processor-based VM-execution controls is 0, VMX non-root operation functions as if the secondary processor-based VM-execution controls were all 0; similarly, if bit 17 of the primary processor-based VM-execution controls is 0, VMX non-root operation functions as if the tertiary processor-based VM-execution controls were all 0. See Section 25.6.2.

An execution of ENQCMD or ENQCMLS performs PASID translation only after checking for conditions that may result in general-protection exception (the check of IA32_PASID.Valid for ENQCMD; the privilege-level check for ENQCMLS), after loading the instruction's source operand from memory, and thus after any faults or VM exits that the loading may cause (e.g., page faults or EPT violations). PASID translation occurs before the actual enqueue store and thus before any faults or VM exits that it may cause.

- **INVPCID.** Behavior of the INVPCID instruction is determined first by the setting of the “enable INVPCID” VM-execution control:
 - If the “enable INVPCID” VM-execution control is 0, INVPCID causes an invalid-opcode exception (#UD). This exception takes priority over any other exception the instruction may incur.
 - If the “enable INVPCID” VM-execution control is 1, treatment is based on the setting of the “INVLPG exiting” VM-execution control:
 - If the “INVLPG exiting” VM-execution control is 0, INVPCID operates normally.
 - If the “INVLPG exiting” VM-execution control is 1, INVPCID causes a VM exit.
- **IRET.** Behavior of IRET with regard to NMI blocking (see Table 25-3) is determined by the settings of the “NMI exiting” and “virtual NMIs” VM-execution controls:
 - If the “NMI exiting” VM-execution control is 0, IRET operates normally and unblocks NMIs. (If the “NMI exiting” VM-execution control is 0, the “virtual NMIs” control must be 0; see Section 27.2.1.1.)
 - If the “NMI exiting” VM-execution control is 1, IRET does not affect blocking of NMIs. If, in addition, the “virtual NMIs” VM-execution control is 1, the logical processor tracks virtual-NMI blocking. In this case, IRET removes any virtual-NMI blocking.

The unblocking of NMIs or virtual NMIs specified above occurs even if IRET causes a fault.

- **LMSW.** Outside of VMX non-root operation, LMSW loads its source operand into CR0[3:0], but it does not clear CR0.PE if that bit is set. In VMX non-root operation, an execution of LMSW that does not cause a VM exit (see Section 26.1.3) leaves unmodified any bit in CR0[3:0] corresponding to a bit set in the CR0 guest/host mask. An attempt to set any other bit in CR0[3:0] to a value not supported in VMX operation (see Section 24.8) causes a general-protection exception. Attempts to clear CR0.PE are ignored without fault.
- **MOV from CR0.** The behavior of MOV from CR0 is determined by the CR0 guest/host mask and the CR0 read shadow. For each position corresponding to a bit clear in the CR0 guest/host mask, the destination operand is loaded with the value of the corresponding bit in CR0. For each position corresponding to a bit set in the CR0 guest/host mask, the destination operand is loaded with the value of the corresponding bit in the CR0 read shadow. Thus, if every bit is cleared in the CR0 guest/host mask, MOV from CR0 reads normally from CR0; if every bit is set in the CR0 guest/host mask, MOV from CR0 returns the value of the CR0 read shadow. Depending on the contents of the CR0 guest/host mask and the CR0 read shadow, bits may be set in the destination that would never be set when reading directly from CR0.
- **MOV from CR3.** If the “enable EPT” VM-execution control is 1 and an execution of MOV from CR3 does not cause a VM exit (see Section 26.1.3), the value loaded from CR3 is a guest-physical address; see Section 29.3.1.
- **MOV from CR4.** The behavior of MOV from CR4 is determined by the CR4 guest/host mask and the CR4 read shadow. For each position corresponding to a bit clear in the CR4 guest/host mask, the destination operand is loaded with the value of the corresponding bit in CR4. For each position corresponding to a bit set in the CR4 guest/host mask, the destination operand is loaded with the value of the corresponding bit in the CR4 read shadow. Thus, if every bit is cleared in the CR4 guest/host mask, MOV from CR4 reads normally from CR4; if every bit is set in the CR4 guest/host mask, MOV from CR4 returns the value of the CR4 read shadow. Depending on the contents of the CR4 guest/host mask and the CR4 read shadow, bits may be set in the destination that would never be set when reading directly from CR4.
- **MOV from CR8.** If the MOV from CR8 instruction does not cause a VM exit (see Section 26.1.3), its behavior is modified if the “use TPR shadow” VM-execution control is 1; see Section 30.3.
- **MOV to CR0.** An execution of MOV to CR0 that does not cause a VM exit (see Section 26.1.3) leaves unmodified any bit in CR0 corresponding to a bit set in the CR0 guest/host mask. Treatment of attempts to modify other bits in CR0 depends on the setting of the “unrestricted guest” VM-execution control:
 - If the control is 0, MOV to CR0 causes a general-protection exception if it attempts to set any bit in CR0 to a value not supported in VMX operation (see Section 24.8).

- If the control is 1, MOV to CR0 causes a general-protection exception if it attempts to set any bit in CR0 other than bit 0 (PE) or bit 31 (PG) to a value not supported in VMX operation. It remains the case, however, that MOV to CR0 causes a general-protection exception if it would result in CR0.PE = 0 and CR0.PG = 1 or if it would result in CR0.PG = 1, CR4.PAE = 0, and IA32_EFER.LME = 1.
- **MOV to CR3.** If the “enable EPT” VM-execution control is 1 and an execution of MOV to CR3 does not cause a VM exit (see Section 26.1.3), the value loaded into CR3 is treated as a guest-physical address; see Section 29.3.1.
 - If PAE paging is not being used, the instruction does not use the guest-physical address to access memory and it does not cause it to be translated through EPT.¹
 - If PAE paging is being used, the instruction translates the guest-physical address through EPT and uses the result to load the four (4) page-directory-pointer-table entries (PDPTEs). The instruction does not use the guest-physical addresses the PDPTEs to access memory and it does not cause them to be translated through EPT.
- **MOV to CR4.** An execution of MOV to CR4 that does not cause a VM exit (see Section 26.1.3) leaves unmodified any bit in CR4 corresponding to a bit set in the CR4 guest/host mask. Such an execution causes a general-protection exception if it attempts to set any bit in CR4 (not corresponding to a bit set in the CR4 guest/host mask) to a value not supported in VMX operation (see Section 24.8).
- **MOV to CR8.** If the MOV to CR8 instruction does not cause a VM exit (see Section 26.1.3), its behavior is modified if the “use TPR shadow” VM-execution control is 1; see Section 30.3.
- **MWAIT.** Behavior of the MWAIT instruction (which always causes an invalid-opcode exception—#UD—if CPL > 0) is determined by the setting of the “MWAIT exiting” VM-execution control:
 - If the “MWAIT exiting” VM-execution control is 1, MWAIT causes a VM exit.
 - If the “MWAIT exiting” VM-execution control is 0, MWAIT operates normally if one of the following are true: (1) ECX[0] is 0; (2) RFLAGS.IF = 1; or both of the following are true: (a) the “interrupt-window exiting” VM-execution control is 0; and (b) the logical processor has not recognized a pending virtual interrupt (see Section 29.2.1).
 - If the “MWAIT exiting” VM-execution control is 0, ECX[0] = 1, and RFLAGS.IF = 0, MWAIT does not cause the processor to enter an implementation-dependent optimized state if either the “interrupt-window exiting” VM-execution control is 1 or the logical processor has recognized a pending virtual interrupt; instead, control passes to the instruction following the MWAIT instruction.
- **PCONFIG.** Behavior of the PCONFIG instruction is determined by the setting of the “enable PCONFIG” VM-execution control:
 - If the “enable PCONFIG” VM-execution control is 0, PCONFIG causes an invalid-opcode exception (#UD). This exception takes priority over any exception the instruction may incur.
 - If the “enable PCONFIG” VM-execution control is 1, PCONFIG may cause a VM exit as specified in Section 26.1.3; if it does not cause such a VM exit, it operates normally.
- **RDMSR.** Section 26.1.3 identifies when executions of the RDMSR instruction cause VM exits. If such an execution causes neither a fault due to CPL > 0 nor a VM exit, the instruction’s behavior may be modified for certain values of ECX:
 - If ECX contains 10H (indicating the IA32_TIME_STAMP_COUNTER MSR), the value returned by the instruction is determined by the setting of the “use TSC offsetting” VM-execution control:
 - If the control is 0, RDMSR operates normally, loading EAX:EDX with the value of the IA32_TIME_STAMP_COUNTER MSR.
 - If the control is 1, the value returned is determined by the setting of the “use TSC scaling” VM-execution control:
 - If the control is 0, RDMSR loads EAX:EDX with the sum of the value of the IA32_TIME_STAMP_COUNTER MSR and the value of the TSC offset.

1. A logical processor uses PAE paging if CR0.PG = 1, CR4.PAE = 1 and IA32_EFER.LMA = 0. See Section 4.4 in the Intel® 64 and IA-32 Architectures Software Developer’s Manual, Volume 3A.

- If the control is 1, RDMSR first computes the product of the value of the IA32_TIME_STAMP_COUNTER MSR and the value of the TSC multiplier. It then shifts the value of the product right 48 bits and loads EAX:EDX with the sum of that shifted value and the value of the TSC offset.

The 1-setting of the “use TSC-offsetting” VM-execution control does not affect executions of RDMSR if ECX contains 6E0H (indicating the IA32_TSC_DEADLINE MSR). Such executions return the APIC-timer deadline relative to the actual timestamp counter without regard to the TSC offset.

- If ECX contains 48H (indicating the IA32_SPEC_CTRL MSR), the value returned by the instruction is determined by the setting of the “virtualize IA32_SPEC_CTRL” VM-execution control:
 - If the control is 0, RDMSR operates normally, loading EAX:EDX with the value of the IA32_SPEC_CTRL MSR.
 - If the control is 1, the value returned is that of the IA32_SPEC_CTRL shadow field in the VMCS.
- If ECX is in the range 800H–8FFH (indicating an APIC MSR), instruction behavior may be modified if the “virtualize x2APIC mode” VM-execution control is 1; see Section 30.5.
- **RDPID.** Behavior of the RDPID instruction is determined first by the setting of the “enable RDTSCP” VM-execution control:
 - If the “enable RDTSCP” VM-execution control is 0, RDPID causes an invalid-opcode exception (#UD).
 - If the “enable RDTSCP” VM-execution control is 1, RDPID operates normally.
- **RDTSR.** Behavior of the RDTSR instruction is determined by the settings of the “RDTSC exiting” and “use TSC offsetting” VM-execution controls:
 - If both controls are 0, RDTSR operates normally.
 - If the “RDTSC exiting” VM-execution control is 0 and the “use TSC offsetting” VM-execution control is 1, the value returned is determined by the setting of the “use TSC scaling” VM-execution control:
 - If the control is 0, RDTSR loads EAX:EDX with the sum of the value of the IA32_TIME_STAMP_COUNTER MSR and the value of the TSC offset.
 - If the control is 1, RDTSR first computes the product of the value of the IA32_TIME_STAMP_COUNTER MSR and the value of the TSC multiplier. It then shifts the value of the product right 48 bits and loads EAX:EDX with the sum of that shifted value and the value of the TSC offset.
 - If the “RDTSC exiting” VM-execution control is 1, RDTSR causes a VM exit.
- **RDTSCP.** Behavior of the RDTSCP instruction is determined first by the setting of the “enable RDTSCP” VM-execution control:
 - If the “enable RDTSCP” VM-execution control is 0, RDTSCP causes an invalid-opcode exception (#UD). This exception takes priority over any other exception the instruction may incur.
 - If the “enable RDTSCP” VM-execution control is 1, treatment is based on the settings of the “RDTSC exiting” and “use TSC offsetting” VM-execution controls:
 - If both controls are 0, RDTSCP operates normally.
 - If the “RDTSC exiting” VM-execution control is 0 and the “use TSC offsetting” VM-execution control is 1, the value returned is determined by the setting of the “use TSC scaling” VM-execution control:
 - If the control is 0, RDTSCP loads EAX:EDX with the sum of the value of the IA32_TIME_STAMP_COUNTER MSR and the value of the TSC offset.
 - If the control is 1, RDTSCP first computes the product of the value of the IA32_TIME_STAMP_COUNTER MSR and the value of the TSC multiplier. It then shifts the value of the product right 48 bits and loads EAX:EDX with the sum of that shifted value and the value of the TSC offset.

In either case, RDTSCP also loads ECX with the value of bits 31:0 of the IA32_TSC_AUX MSR.

 - If the “RDTSC exiting” VM-execution control is 1, RDTSCP causes a VM exit.
- **SMSW.** The behavior of SMSW is determined by the CR0 guest/host mask and the CR0 read shadow. For each position corresponding to a bit clear in the CR0 guest/host mask, the destination operand is loaded with the

value of the corresponding bit in CR0. For each position corresponding to a bit set in the CR0 guest/host mask, the destination operand is loaded with the value of the corresponding bit in the CR0 read shadow. Thus, if every bit is cleared in the CR0 guest/host mask, SMSW reads normally from CR0; if every bit is set in the CR0 guest/host mask, SMSW returns the value of the CR0 read shadow.

Note the following: (1) for any memory destination or for a 16-bit register destination, only the low 16 bits of the CR0 guest/host mask and the CR0 read shadow are used (bits 63:16 of a register destination are left unchanged); (2) for a 32-bit register destination, only the low 32 bits of the CR0 guest/host mask and the CR0 read shadow are used (bits 63:32 of the destination are cleared); and (3) depending on the contents of the CR0 guest/host mask and the CR0 read shadow, bits may be set in the destination that would never be set when reading directly from CR0.

- **TPAUSE.** Behavior of the TPAUSE instruction is determined first by the setting of the “enable user wait and pause” VM-execution control:
 - If the “enable user wait and pause” VM-execution control is 0, TPAUSE causes an invalid-opcode exception (#UD). This exception takes priority over any exception the instruction may incur.
 - If the “enable user wait and pause” VM-execution control is 1, treatment is based on the setting of the “RDTSC exiting” VM-execution control:
 - If the “RDTSC exiting” VM-execution control is 0, the instruction delays for an amount of time called here the **physical delay**. The physical delay is first computed by determining the **virtual delay** (the time to delay relative to the guest’s timestamp counter).
If IA32_UWAIT_CONTROL[31:2] is zero, the virtual delay is the value in EDX:EAX minus the value that RDTSC would return (see above); if IA32_UWAIT_CONTROL[31:2] is not zero, the virtual delay is the minimum of that difference and AND(IA32_UWAIT_CONTROL,FFFFFFFFCH).
The physical delay depends upon the settings of the “use TSC offsetting” and “use TSC scaling” VM-execution controls:
 - If either control is 0, the physical delay is the virtual delay.
 - If both controls are 1, the virtual delay is multiplied by 2^{48} (using a shift) to produce a 128-bit integer. That product is then divided by the TSC multiplier to produce a 64-bit integer. The physical delay is that quotient.
 - If the “RDTSC exiting” VM-execution control is 1, TPAUSE causes a VM exit.
- **UMONITOR.** Behavior of the UMONITOR instruction is determined by the setting of the “enable user wait and pause” VM-execution control:
 - If the “enable user wait and pause” VM-execution control is 0, UMONITOR causes an invalid-opcode exception (#UD). This exception takes priority over any exception the instruction may incur.
 - If the “enable user wait and pause” VM-execution control is 1, UMONITOR operates normally.
- **UWAIT.** Behavior of the UWAIT instruction is determined first by the setting of the “enable user wait and pause” VM-execution control:
 - If the “enable user wait and pause” VM-execution control is 0, UWAIT causes an invalid-opcode exception (#UD). This exception takes priority over any exception the instruction may incur.
 - If the “enable user wait and pause” VM-execution control is 1, treatment is based on the setting of the “RDTSC exiting” VM-execution control:
 - If the “RDTSC exiting” VM-execution control is 0, and if the instruction causes a delay, the amount of time delayed is called here the **physical delay**. The physical delay is first computed by determining the **virtual delay** (the time to delay relative to the guest’s timestamp counter).
If IA32_UWAIT_CONTROL[31:2] is zero, the virtual delay is the value in EDX:EAX minus the value that RDTSC would return (see above); if IA32_UWAIT_CONTROL[31:2] is not zero, the virtual delay is the minimum of that difference and AND(IA32_UWAIT_CONTROL,FFFFFFFFCH).
The physical delay depends upon the settings of the “use TSC offsetting” and “use TSC scaling” VM-execution controls:
 - If either control is 0, the physical delay is the virtual delay.

- If both controls are 1, the virtual delay is multiplied by 2^{48} (using a shift) to produce a 128-bit integer. That product is then divided by the TSC multiplier to produce a 64-bit integer. The physical delay is that quotient.
 - If the “RDTSC exiting” VM-execution control is 1, UMWAIT causes a VM exit.
- **WRMSR.** Section 26.1.3 identifies when executions of the WRMSR instruction cause VM exits. If such an execution neither a fault due to CPL > 0 nor a VM exit, the instruction’s behavior may be modified for certain values of ECX:
 - If ECX contains 48H (indicating the IA32_SPEC_CTRL MSR), instruction behavior depends on the setting of the “virtualize IA32_SPEC_CTRL” VM-execution control:
 - If the control is 0, WRMSR operates normally, loading the IA32_SPEC_CTRL MSR with the value in EAX:EDX.
 - If the control is 1, instruction will attempt to write the IA32_SPEC_CTRL MSR using the instruction’s source operand, but it will attempt to modify only those bits in positions corresponding to bits cleared in the IA32_SPEC_CTRL mask field in the VMCS.

Specifically, the instruction attempts to write the MSR with the following value:

$$(\text{MSR_VAL} \& \text{ISC_MASK}) \text{ OR } (\text{SRC} \& \text{NOT ISC_MASK}),$$

where MSR_VAL is the original value of the MSR, ISC_MASK is the IA32_SPEC_CTRL mask, and SRC is the instruction’s source operand.

Any fault that would result from writing that value to the MSR (e.g., due to a reserved-bit violation) occurs normally. Otherwise, the value is written to the MSR.

Such a write to the MSR will have any side effects that would occur normally had the MSR been written with the value indicated above (including any side effects that may result from writing unchanged values to the masked bits).

If the write completes without a fault, the unmodified value of the source operand is written to the IA32_SPEC_CTRL shadow field in the VMCS.
 - If ECX contains 79H (indicating IA32_BIOS_UPDT_TRIG MSR), no microcode update is loaded, and control passes to the next instruction. This implies that microcode updates cannot be loaded in VMX non-root operation.
 - On processors that support Intel PT but which do not allow it to be used in VMX operation, if ECX contains 570H (indicating the IA32_RTIT_CTL MSR), the instruction causes a general-protection exception.¹
 - If ECX contains 808H (indicating the TPR MSR), 80BH (the EOI MSR), 830H (the ICR MSR), or 83FH (the self-IPI MSR), instruction behavior may be modified if the “virtualize x2APIC mode” VM-execution control is 1; see Section 30.5.
- **XRSTORS.** Behavior of the XRSTORS instruction is determined first by the setting of the “enable XSAVES/XRSTORS” VM-execution control:
 - If the “enable XSAVES/XRSTORS” VM-execution control is 0, XRSTORS causes an invalid-opcode exception (#UD).
 - If the “enable XSAVES/XRSTORS” VM-execution control is 1, treatment is based on the value of the XSS-exiting bitmap (see Section 25.6.21):
 - XRSTORS causes a VM exit if any bit is set in the logical-AND of the following three values: EDX:EAX, the IA32_XSS MSR, and the XSS-exiting bitmap.
 - Otherwise, XRSTORS operates normally.
- **XSAVES.** Behavior of the XSAVES instruction is determined first by the setting of the “enable XSAVES/XRSTORS” VM-execution control:
 - If the “enable XSAVES/XRSTORS” VM-execution control is 0, XSAVES causes an invalid-opcode exception (#UD).

1. Software should read the VMX capability MSR IA32_VMX_MISC to determine whether the processor allows Intel PT to be used in VMX operation (see Appendix A.6).

- If the “enable XSAVES/XRSTORS” VM-execution control is 1, treatment is based on the value of the XSS-exiting bitmap (see Section 25.6.21):
 - XSAVES causes a VM exit if any bit is set in the logical-AND of the following three values: EDX:EAX, the IA32_XSS MSR, and the XSS-exiting bitmap.
 - Otherwise, XSAVES operates normally.

26.4 OTHER CHANGES IN VMX NON-ROOT OPERATION

Treatments of event blocking, task switches, and certain shadow-stack updates may differ in VMX non-root operation as described in the following sections.

26.4.1 Event Blocking

Event blocking is modified in VMX non-root operation as follows:

- If the “external-interrupt exiting” VM-execution control is 1, RFLAGS.IF does not control the blocking of external interrupts. In this case, an external interrupt that is not blocked for other reasons causes a VM exit (even if RFLAGS.IF = 0).
- If the “external-interrupt exiting” VM-execution control is 1, external interrupts may or may not be blocked by STI or by MOV SS (behavior is implementation-specific).
- If the “NMI exiting” VM-execution control is 1, non-maskable interrupts (NMIs) may or may not be blocked by STI or by MOV SS (behavior is implementation-specific).

26.4.2 Treatment of Task Switches

Task switches are not allowed in VMX non-root operation. Any attempt to effect a task switch in VMX non-root operation causes a VM exit. However, the following checks are performed (in the order indicated), possibly resulting in a fault, before there is any possibility of a VM exit due to task switch:

1. If a task gate is being used, appropriate checks are made on its P bit and on the proper values of the relevant privilege fields. The following cases detail the privilege checks performed:
 - a. If CALL, INT *n*, INT1, INT3, INTO, or JMP accesses a task gate in IA-32e mode, a general-protection exception occurs.
 - b. If CALL, INT *n*, INT3, INTO, or JMP accesses a task gate outside IA-32e mode, privilege-levels checks are performed on the task gate but, if they pass, privilege levels are not checked on the referenced task-state segment (TSS) descriptor.
 - c. If CALL or JMP accesses a TSS descriptor directly in IA-32e mode, a general-protection exception occurs.
 - d. If CALL or JMP accesses a TSS descriptor directly outside IA-32e mode, privilege levels are checked on the TSS descriptor.
 - e. If a non-maskable interrupt (NMI), an exception, or an external interrupt accesses a task gate in the IDT in IA-32e mode, a general-protection exception occurs.
 - f. If a non-maskable interrupt (NMI), an exception other than breakpoint exceptions (#BP) and overflow exceptions (#OF), or an external interrupt accesses a task gate in the IDT outside IA-32e mode, no privilege checks are performed.
 - g. If IRET is executed with RFLAGS.NT = 1 in IA-32e mode, a general-protection exception occurs.
 - h. If IRET is executed with RFLAGS.NT = 1 outside IA-32e mode, a TSS descriptor is accessed directly and no privilege checks are made.
2. Checks are made on the new TSS selector (for example, that is within GDT limits).
3. The new TSS descriptor is read. (A page fault results if a relevant GDT page is not present).
4. The TSS descriptor is checked for proper values of type (depends on type of task switch), P bit, S bit, and limit.

Only if checks 1–4 all pass (do not generate faults) might a VM exit occur. However, the ordering between a VM exit due to a task switch and a page fault resulting from accessing the old TSS or the new TSS is implementation-specific. Some processors may generate a page fault (instead of a VM exit due to a task switch) if accessing either TSS would cause a page fault. Other processors may generate a VM exit due to a task switch even if accessing either TSS would cause a page fault.

If an attempt at a task switch through a task gate in the IDT causes an exception (before generating a VM exit due to the task switch) and that exception causes a VM exit, information about the event whose delivery that accessed the task gate is recorded in the IDT-vectoring information fields and information about the exception that caused the VM exit is recorded in the VM-exit interruption-information fields. See Section 28.2. The fact that a task gate was being accessed is not recorded in the VMCS.

If an attempt at a task switch through a task gate in the IDT causes VM exit due to the task switch, information about the event whose delivery accessed the task gate is recorded in the IDT-vectoring fields of the VMCS. Since the cause of such a VM exit is a task switch and not an interruption, the valid bit for the VM-exit interruption information field is 0. See Section 28.2.

26.4.3 Shadow-Stack Updates

As noted in Section 17.2.3, “Supervisor Shadow Stack Token,” in the Intel® 64 and IA-32 Architectures Software Developer’s Manual, Volume 1, a switch of shadow stack may occur as part of IDT event delivery or an execution of far CALL that changes the CPL, or as part of IDT event delivery that uses the interrupt stack table (IST).

As part of the shadow-stack switch, the processor gains exclusive access to the new stack through manipulation of the **supervisor shadow stack token** located at the base of the new shadow stack. The processor reads the token and, among other things, confirms that bit 0 of the token (its **busy bit**) is 0. If the busy bit is already 1, the transition (event delivery or far CALL) cause a general-protection fault and does not complete. If the busy bit is 0, the transition sets the busy bit by writing to the token in memory. (The update is atomic with the original read of the token.)

If the transition commenced with $CPL < 3$, it will follow the token update by pushing three items on the new shadow stack (for the old values of the CS selector, instruction pointer, and shadow-stack pointer). As noted in Section 17.2.3 of the Intel® 64 and IA-32 Architectures Software Developer’s Manual, Volume 1, if any of the pushes causes a VM exit, the processor will revert to the old shadow stack and the busy bit in the new shadow stack’s token remains set. The new shadow stack is said to be prematurely busy.

If the “prematurely busy shadow stack” VM-exit control is 1, a VM exit that results in a shadow stack becoming prematurely busy will indicate that fact through information saved in the VMCS. See Section 28.2.1.

26.5 FEATURES SPECIFIC TO VMX NON-ROOT OPERATION

Some VM-execution controls support features that are specific to VMX non-root operation. These are the VMX-preemption timer (Section 26.5.1) and the monitor trap flag (Section 26.5.2), translation of guest-physical addresses (Section 26.5.3 and Section 26.5.4), APIC virtualization (Section 26.5.5), VM functions (Section 26.5.6), and virtualization exceptions (Section 26.5.7).

26.5.1 VMX-Preemption Timer

If the last VM entry was performed with the 1-setting of “activate VMX-preemption timer” VM-execution control, the **VMX-preemption timer** counts down (from the value loaded by VM entry; see Section 27.7.4) in VMX non-root operation. When the timer counts down to zero, it stops counting down and a VM exit occurs (see Section 26.2).

The VMX-preemption timer counts down at rate proportional to that of the timestamp counter (TSC). Specifically, the timer counts down by 1 every time bit X in the TSC changes due to a TSC increment. The value of X is in the range 0–31 and can be determined by consulting the VMX capability MSR IA32_VMX_MISC (see Appendix A.6).

The VMX-preemption timer operates in the C-states C0, C1, and C2; it also operates in the shutdown and wait-for-SIPI states. If the timer counts down to zero in any state other than the wait-for SIPI state, the logical processor

transitions to the C0 C-state and causes a VM exit; the timer does not cause a VM exit if it counts down to zero in the wait-for-SIPI state. The timer is not decremented in C-states deeper than C2.

Treatment of the timer in the case of system management interrupts (SMIs) and system-management mode (SMM) depends on whether the treatment of SMIs and SMM:

- If the default treatment of SMIs and SMM (see Section 32.14) is active, the VMX-preemption timer counts across an SMI to VMX non-root operation, subsequent execution in SMM, and the return from SMM via the RSM instruction. However, the timer can cause a VM exit only from VMX non-root operation. If the timer expires during SMI, in SMM, or during RSM, a timer-induced VM exit occurs immediately after RSM with its normal priority unless it is blocked based on activity state (Section 26.2).
- If the dual-monitor treatment of SMIs and SMM (see Section 32.15) is active, transitions into and out of SMM are VM exits and VM entries, respectively. The treatment of the VMX-preemption timer by those transitions is mostly the same as for ordinary VM exits and VM entries; Section 32.15.2 and Section 32.15.4 detail some differences.

26.5.2 Monitor Trap Flag

The **monitor trap flag** is a debugging feature that causes VM exits to occur on certain instruction boundaries in VMX non-root operation. Such VM exits are called **MTF VM exits**. An MTF VM exit may occur on an instruction boundary in VMX non-root operation as follows:

- If the “monitor trap flag” VM-execution control is 1 and VM entry is injecting a vectored event (see Section 27.6.1), an MTF VM exit is pending on the instruction boundary before the first instruction following the VM entry.
- If VM entry is injecting a pending MTF VM exit (see Section 27.6.2), an MTF VM exit is pending on the instruction boundary before the first instruction following the VM entry. This is the case even if the “monitor trap flag” VM-execution control is 0.
- If the “monitor trap flag” VM-execution control is 1, VM entry is not injecting an event, and a pending event (e.g., debug exception or interrupt) is delivered before an instruction can execute, an MTF VM exit is pending on the instruction boundary following delivery of the event (or any nested exception).
- Suppose that the “monitor trap flag” VM-execution control is 1, VM entry is not injecting an event, and the first instruction following VM entry is a REP-prefixed string instruction:
 - If the first iteration of the instruction causes a fault, an MTF VM exit is pending on the instruction boundary following delivery of the fault (or any nested exception).
 - If the first iteration of the instruction does not cause a fault, an MTF VM exit is pending on the instruction boundary after that iteration.
- Suppose that the “monitor trap flag” VM-execution control is 1, VM entry is not injecting an event, and the first instruction following VM entry is the XBEGIN instruction. In this case, an MTF VM exit is pending at the fallback instruction address of the XBEGIN instruction. This behavior applies regardless of whether advanced debugging of RTM transactional regions has been enabled (see Section 16.3.7, “RTM-Enabled Debugger Support,” of Intel® 64 and IA-32 Architectures Software Developer’s Manual, Volume 1).
- Suppose that the “monitor trap flag” VM-execution control is 1, VM entry is not injecting an event, and the first instruction following VM entry is neither a REP-prefixed string instruction or the XBEGIN instruction:
 - If the instruction causes a fault, an MTF VM exit is pending on the instruction boundary following delivery of the fault (or any nested exception).¹
 - If the instruction does not cause a fault, an MTF VM exit is pending on the instruction boundary following execution of that instruction. If the instruction is INT1, INT3, or INTO, this boundary follows delivery of any software exception. If the instruction is INT *n*, this boundary follows delivery of a software interrupt. If the instruction is HLT, the MTF VM exit will be from the HLT activity state.

No MTF VM exit occurs if another VM exit occurs before reaching the instruction boundary on which an MTF VM exit would be pending (e.g., due to an exception or triple fault).

1. This item includes the cases of an invalid opcode exception—#UD—generated by the UD0, UD1, and UD2 instructions and a BOUND-range exceeded exception—#BR—generated by the BOUND instruction.

An MTF VM exit occurs on the instruction boundary on which it is pending unless a higher priority event takes precedence or the MTF VM exit is blocked due to the activity state:

- System-management interrupts (SMIs), INIT signals, and higher priority events take priority over MTF VM exits. MTF VM exits take priority over debug-trap exceptions and lower priority events.
- No MTF VM exit occurs if the processor is in either the shutdown activity state or wait-for-SIPI activity state. If a non-maskable interrupt subsequently takes the logical processor out of the shutdown activity state without causing a VM exit, an MTF VM exit is pending after delivery of that interrupt.

Special treatment may apply to Intel SGX instructions or if the logical processor is in enclave mode. See Section 40.2 for details.

26.5.3 Translation of Guest-Physical Addresses Using EPT

The extended page-table mechanism (EPT) is a feature that can be used to support the virtualization of physical memory. When EPT is in use, certain physical addresses are treated as guest-physical addresses and are not used to access memory directly. Instead, guest-physical addresses are translated by traversing a set of EPT paging structures to produce physical addresses that are used to access memory.

Details of the EPT mechanism are given in Section 29.3.

26.5.4 Translation of Guest-Physical Addresses Used by Intel Processor Trace

As described in Chapter 33, Intel® Processor Trace (Intel PT) captures information about software execution using dedicated hardware facilities.

Intel PT can be configured so that the trace output is written to memory using physical addresses. For example, when the ToPA (table of physical addresses) output mechanism is used, the IA32_RTIT_OUTPUT_BASE MSR contains the physical address of the base of the current ToPA. Each entry in that table contains the physical address of an output region in memory. When an output region becomes full, the ToPA output mechanism directs subsequent trace output to the next output region as indicated in the ToPA.

When the “Intel PT uses guest physical addresses” VM-execution control is 1, the logical processor treats the addresses used by Intel PT (the output addresses as well as those used to discover the output addresses) as guest-physical addresses, translating to physical addresses using EPT before trace output is written to memory.

Translating these addresses through EPT implies that the trace-output mechanism may cause EPT violations and VM exits; details are provided in Section 26.5.4.1. Section 26.5.4.2 describes a mechanism that ensures that these VM exits do not cause loss of trace data.

26.5.4.1 Guest-Physical Address Translation for Intel PT: Details

When the “Intel PT uses guest physical addresses” VM-execution control is 1, the addresses used by Intel PT are treated as guest-physical addresses and translated using EPT. These addresses include the addresses of the output regions as well as the addresses of the ToPA entries that contain the output-region addresses.

Translation of accesses by the trace-output process may result in EPT violations or EPT misconfigurations (Section 29.3.3), resulting in VM exits. EPT violations resulting for the trace-output process always cause VM exits and are never converted to virtualization exceptions (Section 26.5.7.1).

If no EPT violation or EPT misconfiguration occurs and if page-modification logging (Section 29.3.6) is enabled, the address of an output region may be added to the page-modification log. If the log is full, a page-modification log-full event occurs, resulting in a VM exit.

If the “virtualize APIC accesses” VM-execution control is 1, a guest-physical address used by the trace-output process may be translated to an address on the APIC-access page. In this case, the access by the trace-output process causes an APIC-access VM exit as discussed in Section 30.4.6.1.

26.5.4.2 Trace-Address Pre-Translation (TAPT)

Because it buffers trace data produced by Intel PT before it is written to memory, the processor ensures that buffered data is not lost when a VM exit disables Intel PT. Specifically, the processor ensures that there is sufficient space left in the current output page for the buffered data. If this were not done, buffered trace data could be lost and the resulting trace corrupted.

To prevent the loss of buffered trace data, the processor uses a mechanism called **trace-address pre-translation (TAPT)**. With TAPT, the processor translates using EPT the guest-physical address of the current output region before that address would be used to write buffered trace data to memory.

Because of TAPT, no translation (and thus no EPT violation) occurs at the time output is written to memory; the writes to memory use translations that were cached as part of TAPT. (The details given in Section 26.5.4.1 apply to TAPT.) TAPT ensures that, if a write to the output region would cause an EPT violation, the resulting VM exit is delivered at the time of TAPT, before the region would be used. This allows software to resolve the EPT violation at that time and ensures that, when it is necessary to write buffered trace data to memory, that data will not be lost due to an EPT violation.

TAPT (and resulting VM exits) may occur at any of the following times:

- When software in VMX non-root operation enables tracing by loading the IA32_RTIT_CTL MSR to set the TraceEn bit, using the WRMSR instruction or the XRSTORS instruction.
Any VM exit resulting from TAPT in this case is trap-like: the WRMSR or XRSTORS completes before the VM exit occurs (for example, the value of CS:RIP saved in the guest-state area of the VMCS references the next instruction).
- At an instruction boundary when one output region becomes full and Intel PT transitions to the next output region.
VM exits resulting from TAPT in this case take priority over any pending debug exceptions. Such a VM exit will save information about such exceptions in the guest-state area of the VMCS.
- As part of a VM entry that enables Intel PT. See Section 27.5 for details.

TAPT may translate not only the guest-physical address of the current output region but those of subsequent output regions as well. (Doing so may provide better protection of trace data.) This implies that any VM exits resulting from TAPT may result from the translation of output-region addresses other than that of the current output region.

26.5.5 APIC Virtualization

APIC virtualization is a collection of features that can be used to support the virtualization of interrupts and the Advanced Programmable Interrupt Controller (APIC). When APIC virtualization is enabled, the processor emulates many accesses to the APIC, tracks the state of the virtual APIC, and delivers virtual interrupts — all in VMX non-root operation without a VM exit.

Details of the APIC virtualization are given in Chapter 30.

26.5.6 VM Functions

A **VM function** is an operation provided by the processor that can be invoked from VMX non-root operation without a VM exit. VM functions are enabled and configured by the settings of different fields in the VMCS. Software in VMX non-root operation invokes a VM function with the **VMFUNC** instruction; the value of EAX selects the specific VM function being invoked.

Section 26.5.6.1 explains how VM functions are enabled. Section 26.5.6.2 specifies the behavior of the VMFUNC instruction. Section 26.5.6.3 describes a specific VM function called **EPTP switching**.

26.5.6.1 Enabling VM Functions

Software enables VM functions generally by setting the “enable VM functions” VM-execution control. A specific VM function is enabled by setting the corresponding VM-function control.

Suppose, for example, that software wants to enable EPTP switching (VM function 0; see Section 25.6.14). To do so, it must set the “activate secondary controls” VM-execution control (bit 31 of the primary processor-based VM-execution controls), the “enable VM functions” VM-execution control (bit 13 of the secondary processor-based VM-execution controls) and the “EPTP switching” VM-function control (bit 0 of the VM-function controls).

26.5.6.2 General Operation of the VMFUNC Instruction

The VMFUNC instruction causes an invalid-opcode exception (#UD) if the “enable VM functions” VM-execution controls is 0¹ or the value of EAX is greater than 63 (only VM functions 0–63 can be enable). Otherwise, the instruction causes a VM exit if the bit at position EAX is 0 in the VM-function controls (the selected VM function is not enabled). If such a VM exit occurs, the basic exit reason used is 59 (3BH), indicating “VMFUNC”, and the length of the VMFUNC instruction is saved into the VM-exit instruction-length field. If the instruction causes neither an invalid-opcode exception nor a VM exit due to a disabled VM function, it performs the functionality of the VM function specified by the value in EAX.

Individual VM functions may perform additional fault checking (e.g., one might cause a general-protection exception if CPL > 0). In addition, specific VM functions may include checks that might result in a VM exit. If such a VM exit occurs, VM-exit information is saved as described in the previous paragraph. The specification of a VM function may indicate that additional VM-exit information is provided.

The specific behavior of the EPTP-switching VM function (including checks that result in VM exits) is given in Section 26.5.6.3.

26.5.6.3 EPTP Switching

EPTP switching is VM function 0. This VM function allows software in VMX non-root operation to load a new value for the EPT pointer (EPTP), thereby establishing a different EPT paging-structure hierarchy (see Section 29.3 for details of the operation of EPT). Software is limited to selecting from a list of potential EPTP values configured in advance by software in VMX root operation.

Specifically, the value of ECX is used to select an entry from the EPTP list, the 4-KByte structure referenced by the EPTP-list address (see Section 25.6.14; because this structure contains 512 8-Byte entries, VMFUNC causes a VM exit if ECX ≥ 512). The EPTP value in the selected entry is evaluated to determine whether it is valid for EPTP switching: a value is valid if (1) it is the same as the current EPTP value in bits 5:3 (these bits specify the EPT page-walk length); and (2) it would not cause VM entry to fail (see Section 27.2.1.1). If the value is invalid, a VM exit occurs. Otherwise, the value is stored in the EPTP field of the current VMCS and is used for subsequent accesses using guest-physical addresses. The following pseudocode provides details:

```
IF ECX ≥ 512
    THEN VM exit;
    ELSE
        tent_EPTP := 8 bytes from EPTP-list address + 8 * ECX;
        IF tent_EPTP is not a valid EPTP value (would cause VM entry to fail if in EPTP or change EPT page-walk length)
            THEN VM exit;
            ELSE
                write tent_EPTP to the EPTP field in the current VMCS;
                use tent_EPTP as the new EPTP value for address translation;
                IF processor supports the 1-setting of the “EPT-violation #VE” VM-execution control
                    THEN
                        write ECX[15:0] to EPTP-index field in current VMCS;
                        use ECX[15:0] as EPTP index for subsequent EPT-violation virtualization exceptions (see Section 26.5.7.2);
                FI;
        FI;
FI;
```

Execution of the EPTP-switching VM function does not modify the state of any registers; no flags are modified.

1. “Enable VM functions” is a secondary processor-based VM-execution control. If bit 31 of the primary processor-based VM-execution controls is 0, VMX non-root operation functions as if the “enable VM functions” VM-execution control were 0. See Section 25.6.2.

If the “Intel PT uses guest physical addresses” VM-execution control is 1 and IA32_RTIT_CTL.TraceEn = 1, any execution of the EPTP-switching VM function causes a VM exit.¹

As noted in Section 26.5.6.2, an execution of the EPTP-switching VM function that causes a VM exit (as specified above), uses the basic exit reason 59, indicating “VMFUNC”. The length of the VMFUNC instruction is saved into the VM-exit instruction-length field. No additional VM-exit information is provided.

An execution of VMFUNC loads EPTP from the EPTP list (and thus does not cause a fault or VM exit) is called an **EPTP-switching VMFUNC**. After an EPTP-switching VMFUNC, control passes to the next instruction. The logical processor starts creating and using guest-physical and combined mappings associated with the new value of bits 51:12 of EPTP; the combined mappings created and used are associated with the current VPID and PCID (these are not changed by VMFUNC).² If the “enable VPID” VM-execution control is 0, an EPTP-switching VMFUNC invalidates combined mappings associated with VPID 0000H (for all PCIDs and for all EPTRTA values, where EPTRTA is the value of bits 51:12 of EPTP).

Because an EPTP-switching VMFUNC may change the translation of guest-physical addresses, it may affect use of the guest-physical address in CR3. The EPTP-switching VMFUNC cannot itself cause a VM exit due to an EPT violation or an EPT misconfiguration due to the translation of that guest-physical address through the new EPT paging structures. The following items provide details that apply if CR0.PG = 1:

- If 32-bit paging or 4-level paging³ is in use (either CR4.PAE = 0 or IA32_EFER.LMA = 1), the next memory access with a linear address uses the translation of the guest-physical address in CR3 through the new EPT paging structures. As a result, this access may cause a VM exit due to an EPT violation or an EPT misconfiguration encountered during that translation.
- If PAE paging is in use (CR4.PAE = 1 and IA32_EFER.LMA = 0), an EPTP-switching VMFUNC **does not** load the four page-directory-pointer-table entries (PDPTes) from the guest-physical address in CR3. The logical processor continues to use the four guest-physical addresses already present in the PDPTes. The guest-physical address in CR3 is not translated through the new EPT paging structures (until some operation that would load the PDPTes).

The EPTP-switching VMFUNC cannot itself cause a VM exit due to an EPT violation or an EPT misconfiguration encountered during the translation of a guest-physical address in any of the PDPTes. A subsequent memory access with a linear address uses the translation of the guest-physical address in the appropriate PDPTE through the new EPT paging structures. As a result, such an access may cause a VM exit due to an EPT violation or an EPT misconfiguration encountered during that translation.

If an EPTP-switching VMFUNC establishes an EPTP value that enables accessed and dirty flags for EPT (by setting bit 6), subsequent memory accesses may fail to set those flags as specified if there has been no appropriate execution of INVEPT since the last use of an EPTP value that does not enable accessed and dirty flags for EPT (because bit 6 is clear) and that is identical to the new value on bits 51:12.

If the processor supports the 1-setting of the “EPT-violation #VE” VM-execution control, an EPTP-switching VMFUNC loads the value in ECX[15:0] into to EPTP-index field in current VMCS. Subsequent EPT-violation virtualization exceptions will save this value into the virtualization-exception information area (see Section 26.5.7.2).

26.5.7 Virtualization Exceptions

A **virtualization exception** is a new processor exception. It uses vector 20 and is abbreviated #VE.

A virtualization exception can occur only in VMX non-root operation. Virtualization exceptions occur only with certain settings of certain VM-execution controls. Generally, these settings imply that certain conditions that would normally cause VM exits instead cause virtualization exceptions

In particular, the 1-setting of the “EPT-violation #VE” VM-execution control causes some EPT violations to generate virtualization exceptions instead of VM exits. Section 26.5.7.1 provides the details of how the processor determines whether an EPT violation causes a virtualization exception or a VM exit.

-
1. Such a VM exit ensures the proper recording of trace data that might otherwise be lost during the change of EPT paging-structure hierarchy. Software handling the VM exit can change emulate the VM function and then resume the guest.
 2. If the “enable VPID” VM-execution control is 0, the current VPID is 0000H; if CR4.PCIDE = 0, the current PCID is 000H.
 3. Earlier versions of this manual used the term “IA-32e paging” to identify 4-level paging.

When the processor encounters a virtualization exception, it saves information about the exception to the virtualization-exception information area; see Section 26.5.7.2.

After saving virtualization-exception information, the processor delivers a virtualization exception as it would any other exception; see Section 26.5.7.3 for details.

26.5.7.1 Convertible EPT Violations

If the “EPT-violation #VE” VM-execution control is 0 (e.g., on processors that do not support this feature), EPT violations always cause VM exits. If instead the control is 1, certain EPT violations may be converted to cause virtualization exceptions instead; such EPT violations are **convertible**.

The values of certain EPT paging-structure entries determine which EPT violations are convertible. Specifically, bit 63 of certain EPT paging-structure entries may be defined to mean **suppress #VE**:

- If bits 2:0 of an EPT paging-structure entry are all 0, the entry is not **present**.¹ If the processor encounters such an entry while translating a guest-physical address, it causes an EPT violation. The EPT violation is convertible if and only if bit 63 of the entry is 0.
- If an EPT paging-structure entry is present, the following cases apply:
 - If the value of the EPT paging-structure entry is not supported, the entry is **misconfigured**. If the processor encounters such an entry while translating a guest-physical address, it causes an EPT misconfiguration (not an EPT violation). EPT misconfigurations always cause VM exits.
 - If the value of the EPT paging-structure entry is supported, the following cases apply:
 - If bit 7 of the entry is 1, or if the entry is an EPT PTE, the entry maps a page. If the processor uses such an entry to translate a guest-physical address, and if an access to that address causes an EPT violation, the EPT violation is convertible if and only if bit 63 of the entry is 0.
 - If bit 7 of the entry is 0 and the entry is not an EPT PTE, the entry references another EPT paging structure. The processor does not use the value of bit 63 of the entry to determine whether any subsequent EPT violation is convertible.

If an access to a guest-physical address causes an EPT violation, bit 63 of exactly one of the EPT paging-structure entries used to translate that address is used to determine whether the EPT violation is convertible: either a entry that is not present (if the guest-physical address does not translate to a physical address) or an entry that maps a page (if it does).

A convertible EPT violation instead causes a virtualization exception if the following all hold:

- CR0.PE = 1;
- the logical processor is not in the process of delivering an event through the IDT;
- the EPT violation did not cause a shadow stack to become prematurely busy (see Section 26.4.3);
- the EPT violation does not result from the output process of Intel Processor Trace (Section 26.5.4); and
- the 32 bits at offset 4 in the virtualization-exception information area are all 0.

Delivery of virtualization exceptions writes the value FFFFFFFFH to offset 4 in the virtualization-exception information area (see Section 26.5.7.2). Thus, once a virtualization exception occurs, another can occur only if software clears this field.

26.5.7.2 Virtualization-Exception Information

Virtualization exceptions save data into the virtualization-exception information area (see Section 25.6.20). Table 26-1 enumerates the data saved and the format of the area.

A VMM may allow guest software to access the virtualization-exception information area. If it does, the guest software may modify that memory (e.g., to clear the 32-bit value at offset 4; see Section 26.5.7.1). (This is an exception to the general requirement given in Section 25.11.4.)

1. If the “mode-based execute control for EPT” VM-execution control is 1, an EPT paging-structure entry is present if any of bits 2:0 or bit 10 is 1.

Table 26-1. Format of the Virtualization-Exception Information Area

Byte Offset	Contents
0	The 32-bit value that would have been saved into the VMCS as an exit reason had a VM exit occurred instead of the virtualization exception. For EPT violations, this value is 48 (00000030H)
4	FFFFFFFFH
8	The 64-bit value that would have been saved into the VMCS as an exit qualification had a VM exit occurred instead of the virtualization exception
16	The 64-bit value that would have been saved into the VMCS as a guest-linear address had a VM exit occurred instead of the virtualization exception
24	The 64-bit value that would have been saved into the VMCS as a guest-physical address had a VM exit occurred instead of the virtualization exception
32	The current 16-bit value of the EPTP index VM-execution control (see Section 25.6.20 and Section 26.5.6.3)

26.5.7.3 Delivery of Virtualization Exceptions

After saving virtualization-exception information, the processor treats a virtualization exception as it does other exceptions:

- If bit 20 (#VE) is 1 in the exception bitmap in the VMCS, a virtualization exception causes a VM exit (see below). If the bit is 0, the virtualization exception is delivered using gate descriptor 20 in the IDT.
- Virtualization exceptions produce no error code. Delivery of a virtualization exception pushes no error code on the stack.
- With respect to double faults, virtualization exceptions have the same severity as page faults. If delivery of a virtualization exception encounters a nested fault that is either contributory or a page fault, a double fault (#DF) is generated. See Chapter 6, “Interrupt 8—Double Fault Exception (#DF)” in Intel® 64 and IA-32 Architectures Software Developer’s Manual, Volume 3A.

It is not possible for a virtualization exception to be encountered while delivering another exception (see Section 26.5.7.1).

If a virtualization exception causes a VM exit directly (because bit 20 is 1 in the exception bitmap), information about the exception is saved normally in the VM-exit interruption information field in the VMCS (see Section 28.2.2). Specifically, the event is reported as a hardware exception with vector 20 and no error code. Bit 12 of the field (NMI unblocking due to IRET) is set normally.

If a virtualization exception causes a VM exit indirectly (because bit 20 is 0 in the exception bitmap and delivery of the exception generates an event that causes a VM exit), information about the exception is saved normally in the IDT-vectoring information field in the VMCS (see Section 28.2.4). Specifically, the event is reported as a hardware exception with vector 20 and no error code.

26.5.8 PASID Translation

The ENQCMD and ENQCMDs instructions each performs a 64-byte enqueue store that includes a 20-bit PASID value in bits 19:0. For ENQCMD, the PASID is normally the value of IA32_PASID[19:0], while for ENQCMDs, the PASID is normally read from memory.

If the “PASID translation” VM-execution control is 1, the PASID value identified in the previous paragraph is treated as a **guest PASID**. PASID translation converts this guest PASID to a 20-bit **host PASID**. After this translation, the enqueue store is performed, using the host PASID in place of the guest PASID.

PASID translation is implemented by two hierarchies of data structures (**PASID-translation hierarchies**) configured by a VMM. Guest PASIDs 00000H to 7FFFFH are translated through the low PASID-translation hierarchy, while guest PASIDs 80000 to FFFFFH are translated through the high PASID-translation hierarchy.

The root of each PASID-translation hierarchy is a 4-KByte **PASID directory**. The low PASID directory is located at the low PASID directory address, and the high PASID directory is located at the high PASID directory address (these physical addresses are VM-execution control fields in the VMCS). A PASID directory comprises 512 8-byte entries, each of which has the following format:

- Bit 0 is the entry's present bit. The entry is used only if this bit is 1.
- Bits 11:1 are reserved and must be 0.
- Bits M-1:12 specify the 4-KByte aligned address of a PASID table (see below), where M is the processor's physical-address width.
- Bits 63:M are reserved and must be 0.

A PASID-translation hierarchy also includes up to 512 4-KByte **PASID tables**; each of these is referenced by a PASID directory entry (see above). A PASID table comprises 1024 4-byte entries, each of which has the following format:

- Bits 19:0 are the host PASID specified by the entry.
- Bits 30:20 are reserved and must be 0.
- Bit 31 is the entry's valid bit. The entry is used only if this bit is 1.

When PASID translation is enabled, the guest PASID determined by the instruction (see above) is converted to a host PASID using the following process:

- If bit 19 of guest PASID is clear, the low PASID directory is used; otherwise, the high PASID directory is used.
- Bits 18:10 of the guest PASID select an entry from the PASID directory. A VM exit occurs if the entry's present bit is clear or if any reserved bit is set. Otherwise, bits M:0 of the entry (with bit 0 cleared) contain the physical address of a PASID table.
- Bits 9:0 of the guest PASID select an entry from the PASID table. A VM exit occurs if the entry's valid bit is clear or if any reserved bit is set. Otherwise, bits 19:0 of the entry are the host PASID.

If PASID translation results in a VM exit (due to a present or valid bit being clear, or a reserved bit being set), the instruction does not complete and no enqueue store is performed.

26.6 UNRESTRICTED GUESTS

The first processors to support VMX operation require CR0.PE and CR0.PG to be 1 in VMX operation (see Section 24.8). This restriction implies that guest software cannot be run in unpagged protected mode or in real-address mode. Later processors support a VM-execution control called "unrestricted guest".¹ If this control is 1, CR0.PE and CR0.PG may be 0 in VMX non-root operation. Such processors allow guest software to run in unpagged protected mode or in real-address mode. The following items describe the behavior of such software:

- The MOV CR0 instructions does not cause a general-protection exception simply because it would set either CR0.PE and CR0.PG to 0. See Section 26.3 for details.
- A logical processor treats the values of CR0.PE and CR0.PG in VMX non-root operation just as it does outside VMX operation. Thus, if CR0.PE = 0, the processor operates as it does normally in real-address mode (for example, it uses the 16-bit **interrupt table** to deliver interrupts and exceptions). If CR0.PG = 0, the processor operates as it does normally when paging is disabled.
- Processor operation is modified by the fact that the processor is in VMX non-root operation and by the settings of the VM-execution controls just as it is in protected mode or when paging is enabled. Instructions, interrupts, and exceptions that cause VM exits in protected mode or when paging is enabled also do so in real-address mode or when paging is disabled. The following examples should be noted:
 - If CR0.PG = 0, page faults do not occur and thus cannot cause VM exits.
 - If CR0.PE = 0, invalid-TSS exceptions do not occur and thus cannot cause VM exits.

1. "Unrestricted guest" is a secondary processor-based VM-execution control. If bit 31 of the primary processor-based VM-execution controls is 0, VMX non-root operation functions as if the "unrestricted guest" VM-execution control were 0. See Section 25.6.2.

- If CR0.PE = 0, the following instructions cause invalid-opcode exceptions and do not cause VM exits: INVEPT, INVVPID, LLDT, LTR, SLDT, STR, VMCLEAR, VMLAUNCH, VMPTRLD, VMPTRST, VMREAD, VMRESUME, VMWRITE, VMXOFF, and VMXON.
- If CR0.PG = 0, each linear address is passed directly to the EPT mechanism for translation to a physical address.¹ The guest memory type passed on to the EPT mechanism is WB (writeback).

1. As noted in Section 27.2.1.1, the “enable EPT” VM-execution control must be 1 if the “unrestricted guest” VM-execution control is 1.

Software can enter VMX non-root operation using either of the VM-entry instructions VMLAUNCH and VMRESUME. VMLAUNCH can be used only with a VMCS whose launch state is clear and VMRESUME can be used only with a VMCS whose the launch state is launched. VMLAUNCH should be used for the first VM entry after VMCLEAR; VMRESUME should be used for subsequent VM entries with the same VMCS.

Each VM entry performs the following steps in the order indicated:

1. Basic checks are performed to ensure that VM entry can commence (Section 27.1).
2. The control and host-state areas of the VMCS are checked to ensure that they are proper for supporting VMX non-root operation and that the VMCS is correctly configured to support the next VM exit (Section 27.2).
3. The following may be performed in parallel or in any order (Section 27.3):
 - The guest-state area of the VMCS is checked to ensure that, after the VM entry completes, the state of the logical processor is consistent with IA-32 and Intel 64 architectures.
 - Processor state is loaded from the guest-state area and based on controls in the VMCS.
 - Address-range monitoring is cleared.
4. MSRs are loaded from the VM-entry MSR-load area (Section 27.4).
5. If VMLAUNCH is being executed, the launch state of the VMCS is set to “launched.”
6. If the “Intel PT uses guest physical addresses” VM-execution control is 1, trace-address pre-translation (TAPT) may occur (see Section 26.5.4 and Section 27.5).
7. An event may be injected in the guest context (Section 27.6).

Steps 1–4 above perform checks that may cause VM entry to fail. Such failures occur in one of the following three ways:

- Some of the checks in Section 27.1 may generate ordinary faults (for example, an invalid-opcode exception). Such faults are delivered normally.
- Some of the checks in Section 27.1 and all the checks in Section 27.2 cause control to pass to the instruction following the VM-entry instruction. The failure is indicated by setting RFLAGS.ZF¹ (if there is a current VMCS) or RFLAGS.CF (if there is no current VMCS). If there is a current VMCS, an error number indicating the cause of the failure is stored in the VM-instruction error field. See Chapter 31 for the error numbers.
- The checks in Section 27.3 and Section 27.4 cause processor state to be loaded from the host-state area of the VMCS (as would be done on a VM exit). Information about the failure is stored in the VM-exit information fields. See Section 27.8 for details.

EFLAGS.TF = 1 causes a VM-entry instruction to generate a single-step debug exception only if failure of one of the checks in Section 27.1 and Section 27.2 causes control to pass to the following instruction. A VM-entry does not generate a single-step debug exception in any of the following cases: (1) the instruction generates a fault; (2) failure of one of the checks in Section 27.3 or in loading MSRs causes processor state to be loaded from the host-state area of the VMCS; or (3) the instruction passes all checks in Section 27.1, Section 27.2, and Section 27.3 and there is no failure in loading MSRs.

Section 32.15 describes the dual-monitor treatment of system-management interrupts (SMIs) and system-management mode (SMM). Under this treatment, code running in SMM returns using VM entries instead of the RSM instruction. A VM entry **returns from SMM** if it is executed in SMM and the “entry to SMM” VM-entry control is 0. VM entries that return from SMM differ from ordinary VM entries in ways that are detailed in Section 32.15.4.

1. This chapter uses the notation RAX, RIP, RSP, RFLAGS, etc. for processor registers because most processors that support VMX operation also support Intel 64 architecture. For IA-32 processors, this notation refers to the 32-bit forms of those registers (EAX, EIP, ESP, EFLAGS, etc.). In a few places, notation such as EAX is used to refer specifically to lower 32 bits of the indicated register.

27.1 BASIC VM-ENTRY CHECKS

Before a VM entry commences, the current state of the logical processor is checked in the following order:

1. If the logical processor is in virtual-8086 mode or compatibility mode, an invalid-opcode exception is generated.
2. If the current privilege level (CPL) is not zero, a general-protection exception is generated.
3. If there is no current VMCS, RFLAGS.CF is set to 1 and control passes to the next instruction.
4. If there is a current VMCS but the current VMCS is a shadow VMCS (see Section 25.10), RFLAGS.CF is set to 1 and control passes to the next instruction.
5. If there is a current VMCS that is not a shadow VMCS, the following conditions are evaluated in order; any of these cause VM entry to fail:
 - a. If there is MOV-SS blocking (see Table 25-3).
 - b. If the VM entry is invoked by VMLAUNCH and the VMCS launch state is not clear.
 - c. If the VM entry is invoked by VMRESUME and the VMCS launch state is not launched.

If any of these checks fail, RFLAGS.ZF is set to 1 and control passes to the next instruction. An error number indicating the cause of the failure is stored in the VM-instruction error field. See Chapter 31 for the error numbers.

27.2 CHECKS ON VMX CONTROLS AND HOST-STATE AREA

If the checks in Section 27.1 do not cause VM entry to fail, the control and host-state areas of the VMCS are checked to ensure that they are proper for supporting VMX non-root operation, that the VMCS is correctly configured to support the next VM exit, and that, after the next VM exit, the processor's state is consistent with the Intel 64 and IA-32 architectures.

VM entry fails if any of these checks fail. When such failures occur, control is passed to the next instruction, RFLAGS.ZF is set to 1 to indicate the failure, and the VM-instruction error field is loaded with an error number that indicates whether the failure was due to the controls or the host-state area (see Chapter 31).

These checks may be performed in any order. Thus, an indication by error number of one cause (for example, host state) does not imply that there are not also other errors. Different processors may thus give different error numbers for the same VMCS. Some checks prevent establishment of settings (or combinations of settings) that are currently reserved. Future processors may allow such settings (or combinations) and may not perform the corresponding checks. The correctness of software should not rely on VM-entry failures resulting from the checks documented in this section.

The checks on the controls and the host-state area are presented in Section 27.2.1 through Section 27.2.4. These sections reference VMCS fields that correspond to processor state. Unless otherwise stated, these references are to fields in the host-state area.

27.2.1 Checks on VMX Controls

This section identifies VM-entry checks on the VMX control fields.

27.2.1.1 VM-Execution Control Fields

VM entries perform the following checks on the VM-execution control fields:¹

- Reserved bits in the pin-based VM-execution controls must be set properly. Software may consult the VMX capability MSRs to determine the proper settings (see Appendix A.3.1).

1. If the "activate secondary controls" primary processor-based VM-execution control is 0, VM entry operates as if each secondary processor-based VM-execution control were 0. Similarly, if the "activate tertiary controls" primary processor-based VM-execution control is 0, VM entry operates as if each tertiary processor-based VM-execution control were 0. See Section 25.6.2.

- Reserved bits in the primary processor-based VM-execution controls must be set properly. Software may consult the VMX capability MSR to determine the proper settings (see Appendix A.3.2).
- If the “activate secondary controls” primary processor-based VM-execution control is 1, reserved bits in the secondary processor-based VM-execution controls must be cleared. Software may consult the VMX capability MSR to determine which bits are reserved (see Appendix A.3.3).
If the “activate secondary controls” primary processor-based VM-execution control is 0 (or if the processor does not support the 1-setting of that control), no checks are performed on the secondary processor-based VM-execution controls. The logical processor operates as if all the secondary processor-based VM-execution controls were 0.
- If the “activate tertiary controls” primary processor-based VM-execution control is 1, reserved bits in the tertiary processor-based VM-execution controls must be cleared. Software may consult the VMX capability MSR to determine which bits are reserved (see Appendix A.3.4).
If the “activate tertiary controls” primary processor-based VM-execution control is 0 (or if the processor does not support the 1-setting of that control), no checks are performed on the tertiary processor-based VM-execution controls. The logical processor operates as if all the tertiary processor-based VM-execution controls were 0.
- The CR3-target count must not be greater than 4. Future processors may support a different number of CR3-target values. Software should read the VMX capability MSR IA32_VMX_MISC to determine the number of values supported (see Appendix A.6).
- If the “use I/O bitmaps” VM-execution control is 1, bits 11:0 of each I/O-bitmap address must be 0. Neither address should set any bits beyond the processor’s physical-address width.^{1,2}
- If the “use MSR bitmaps” VM-execution control is 1, bits 11:0 of the MSR-bitmap address must be 0. The address should not set any bits beyond the processor’s physical-address width.³
- If the “use TPR shadow” VM-execution control is 1, the virtual-APIC address must satisfy the following checks:
 - Bits 11:0 of the address must be 0.
 - The address should not set any bits beyond the processor’s physical-address width.⁴
 If all of the above checks are satisfied and the “use TPR shadow” VM-execution control is 1, bytes 3:1 of VTPR (see Section 30.1.1) may be cleared (behavior may be implementation-specific).
The clearing of these bytes may occur even if the VM entry fails. This is true either if the failure causes control to pass to the instruction following the VM-entry instruction or if it causes processor state to be loaded from the host-state area of the VMCS.
- If the “use TPR shadow” VM-execution control is 1 and the “virtual-interrupt delivery” VM-execution control is 0, bits 31:4 of the TPR threshold VM-execution control field must be 0.
- The following check is performed if the “use TPR shadow” VM-execution control is 1 and the “virtualize APIC accesses” and “virtual-interrupt delivery” VM-execution controls are both 0: the value of bits 3:0 of the TPR threshold VM-execution control field should not be greater than the value of bits 7:4 of VTPR (see Section 30.1.1).
- If the “NMI exiting” VM-execution control is 0, the “virtual NMIs” VM-execution control must be 0.
- If the “virtual NMIs” VM-execution control is 0, the “NMI-window exiting” VM-execution control must be 0.
- If the “virtualize APIC-accesses” VM-execution control is 1, the APIC-access address must satisfy the following checks:
 - Bits 11:0 of the address must be 0.
 - The address should not set any bits beyond the processor’s physical-address width.⁵

1. Software can determine a processor’s physical-address width by executing CPUID with 80000008H in EAX. The physical-address width is returned in bits 7:0 of EAX.

2. If IA32_VMX_BASIC[48] is read as 1, these addresses must not set any bits in the range 63:32; see Appendix A.1.

3. If IA32_VMX_BASIC[48] is read as 1, this address must not set any bits in the range 63:32; see Appendix A.1.

4. If IA32_VMX_BASIC[48] is read as 1, this address must not set any bits in the range 63:32; see Appendix A.1.

5. If IA32_VMX_BASIC[48] is read as 1, this address must not set any bits in the range 63:32; see Appendix A.1.

- If the “use TPR shadow” VM-execution control is 0, the following VM-execution controls must also be 0: “virtualize x2APIC mode”, “APIC-register virtualization”, “virtual-interrupt delivery”, and “IPI virtualization”.
- If the “virtualize x2APIC mode” VM-execution control is 1, the “virtualize APIC accesses” VM-execution control must be 0.
- If the “virtual-interrupt delivery” VM-execution control is 1, the “external-interrupt exiting” VM-execution control must be 1.
- If the “process posted interrupts” VM-execution control is 1, the following must be true:
 - The “virtual-interrupt delivery” VM-execution control is 1.
 - The “acknowledge interrupt on exit” VM-exit control is 1.
 - The posted-interrupt notification vector has a value in the range 0–255 (bits 15:8 are all 0).
 - Bits 5:0 of the posted-interrupt descriptor address are all 0.
 - The posted-interrupt descriptor address does not set any bits beyond the processor’s physical-address width.¹
- If the “IPI virtualization” VM-execution control is 1, the following must be true:
 - Bits 2:0 of the PID-pointer table address are all 0.
 - The PID-pointer table address does not set any bits beyond the processor’s physical-address width.
 - The address of the last entry in the PID-pointer table does not set any bits beyond the processor’s physical-address width. (This address is the PID-pointer table address plus 8 times the last PID-pointer index.)
- If the “enable VPID” VM-execution control is 1, the value of the VPID VM-execution control field must not be 0000H.
- If the “enable EPT” VM-execution control is 1, the EPTP VM-execution control field (see Table 25-9 in Section 25.6.11) must satisfy the following checks:
 - The EPT memory type (bits 2:0) must be a value supported by the processor as indicated in the IA32_VMX_EPT_VPID_CAP MSR (see Appendix A.10).
 - Bits 5:3 must contain a value 1 less than an EPT page-walk length supported by the processor as indicated in the IA32_VMX_EPT_VPID_CAP MSR (see Section 29.3.2 and Appendix A.10).
 - Bit 6 (enable bit for accessed and dirty flags for EPT) must be 0 if bit 21 of the IA32_VMX_EPT_VPID_CAP MSR (see Appendix A.10) is read as 0, indicating that the processor does not support accessed and dirty flags for EPT.
 - Reserved bits 11:7 and 63:N (where N is the processor’s physical-address width) must all be 0.
- The “enable EPT” VM-execution control must be 1 if any of the following VM-execution controls is 1: “enable PML”, “unrestricted guest”, “mode-based execute control for EPT”, “sub-page write permissions for EPT”, “Intel PT uses guest physical addresses”, “enable HLAT”, “EPT paging-write control”, or “guest-paging verification”.
- If the “enable PML” VM-execution control is 1, the PML address must satisfy the following checks:
 - Bits 11:0 of the address must be 0.
 - The address should not set any bits beyond the processor’s physical-address width.
- If the “sub-page write permissions for EPT” VM-execution control is 1, the SPPTP VM-execution control field (see Table 25-11 in Section 25.6.22) must satisfy the following checks:
 - Bits 11:0 of the address must be 0.
 - The address should not set any bits beyond the processor’s physical-address width.
- If the “enable VM functions” processor-based VM-execution control is 1, reserved bits in the VM-function controls must be clear. Software may consult the VMX capability MSRs to determine which bits are reserved (see Appendix A.11). In addition, the following check is performed based on the setting of bits in the VM-function controls (see Section 25.6.14):

1. If IA32_VMX_BASIC[48] is read as 1, this address must not set any bits in the range 63:32; see Appendix A.1.

- If “EPTP switching” VM-function control is 1, the “enable EPT” VM-execution control must also be 1. In addition, the EPTP-list address must satisfy the following checks:
 - Bits 11:0 of the address must be 0.
 - The address must not set any bits beyond the processor’s physical-address width.

If the “enable VM functions” processor-based VM-execution control is 0, no checks are performed on the VM-function controls.

- If the “VMCS shadowing” VM-execution control is 1, the VMREAD-bitmap and VMWRITE-bitmap addresses must each satisfy the following checks:
 - Bits 11:0 of the address must be 0.
 - The address must not set any bits beyond the processor’s physical-address width.
- If the “EPT-violation #VE” VM-execution control is 1, the virtualization-exception information address must satisfy the following checks:
 - Bits 11:0 of the address must be 0.
 - The address must not set any bits beyond the processor’s physical-address width.
- If the logical processor is operating with Intel PT enabled (if IA32_RTIT_CTL.TraceEn = 1) at the time of VM entry, the “load IA32_RTIT_CTL” VM-entry control must be 0.
- If the “Intel PT uses guest physical addresses” VM-execution control is 1, the “load IA32_RTIT_CTL” VM-entry control and the “clear IA32_RTIT_CTL” VM-exit control must both be 1.
- If the “use TSC scaling” VM-execution control is 1, the TSC-multiplier must not be zero.
- If the “enable HLAT” VM-execution control is 1, the following bits in the HLATP VM-execution control field (see Table 25-12 in Section 25.6.23) must be zero: bits 2:0, bits 11:5, and bits beyond the processor’s physical-address width.
- If the “PASID translation” VM-execution control is 1, the low PASID directory address and the high PASID directory address must each satisfy the following checks:
 - Bits 11:0 of the address must be 0.
 - The address must not set any bits beyond the processor’s physical-address width.

27.2.1.2 VM-Exit Control Fields

VM entries perform the following checks on the VM-exit control fields.

- Reserved bits in the primary VM-exit controls must be set properly. Software may consult the VMX capability MSRs to determine the proper settings (see Appendix A.4.1).
- If the “activate secondary controls” primary VM-exit control is 1, reserved bits in the secondary VM-exit controls must be cleared. Software may consult the VMX capability MSRs to determine which bits are reserved (see Appendix A.4.2).
- If the “activate secondary controls” primary VM-exit control is 0 (or if the processor does not support the 1-setting of that control), no checks are performed on the secondary VM-exit controls. The logical processor operates as if all the secondary VM-exit controls were 0.
- If the “activate VMX-preemption timer” VM-execution control is 0, the “save VMX-preemption timer value” VM-exit control must also be 0.
- The following checks are performed for the VM-exit MSR-store address if the VM-exit MSR-store count field is non-zero:
 - The lower 4 bits of the VM-exit MSR-store address must be 0. The address should not set any bits beyond the processor’s physical-address width.¹

1. Software can determine a processor’s physical-address width by executing CPUID with 80000008H in EAX. The physical-address width is returned in bits 7:0 of EAX.

- The address of the last byte in the VM-exit MSR-store area should not set any bits beyond the processor's physical-address width. The address of this last byte is VM-exit MSR-store address + (MSR count * 16) - 1. (The arithmetic used for the computation uses more bits than the processor's physical-address width.)

If IA32_VMX_BASIC[48] is read as 1, neither address should set any bits in the range 63:32; see Appendix A.1.

- The following checks are performed for the VM-exit MSR-load address if the VM-exit MSR-load count field is non-zero:
 - The lower 4 bits of the VM-exit MSR-load address must be 0. The address should not set any bits beyond the processor's physical-address width.
 - The address of the last byte in the VM-exit MSR-load area should not set any bits beyond the processor's physical-address width. The address of this last byte is VM-exit MSR-load address + (MSR count * 16) - 1. (The arithmetic used for the computation uses more bits than the processor's physical-address width.)
- If IA32_VMX_BASIC[48] is read as 1, neither address should set any bits in the range 63:32; see Appendix A.1.

27.2.1.3 VM-Entry Control Fields

VM entries perform the following checks on the VM-entry control fields.

- Reserved bits in the VM-entry controls must be set properly. Software may consult the VMX capability MSRs to determine the proper settings (see Appendix A.5).
- Fields relevant to VM-entry event injection must be set properly. These fields are the VM-entry interruption-information field (see Table 25-17 in Section 25.8.3), the VM-entry exception error code, and the VM-entry instruction length. If the valid bit (bit 31) in the VM-entry interruption-information field is 1, the following must hold:
 - The field's interruption type (bits 10:8) is not set to a reserved value. Value 1 is reserved on all logical processors; value 7 (other event) is reserved on logical processors that do not support the 1-setting of the "monitor trap flag" VM-execution control.
 - The field's vector (bits 7:0) is consistent with the interruption type:
 - If the interruption type is non-maskable interrupt (NMI), the vector is 2.
 - If the interruption type is hardware exception, the vector is at most 31.
 - If the interruption type is other event, the vector is 0 (pending MTF VM exit).
 - The field's deliver-error-code bit (bit 11) is 1 if each of the following holds: (1) the interruption type is hardware exception; (2) bit 0 (corresponding to CR0.PE) is set in the CR0 field in the guest-state area; (3) IA32_VMX_BASIC[56] is read as 0 (see Appendix A.1); and (4) the vector indicates one of the following exceptions: #DF (vector 8), #TS (10), #NP (11), #SS (12), #GP (13), #PF (14), or #AC (17).
 - The field's deliver-error-code bit is 0 if any of the following holds: (1) the interruption type is not hardware exception; (2) bit 0 is clear in the CR0 field in the guest-state area; or (3) IA32_VMX_BASIC[56] is read as 0 and the vector is in one of the following ranges: 0-7, 9, 15, 16, or 18-31.
 - Reserved bits in the field (30:12) are 0.
 - If the deliver-error-code bit (bit 11) is 1, bits 31:16 of the VM-entry exception error-code field are 0.
 - If the interruption type is software interrupt, software exception, or privileged software exception, the VM-entry instruction-length field is in the range 0-15. A VM-entry instruction length of 0 is allowed only if IA32_VMX_MISC[30] is read as 1; see Appendix A.6.
- The following checks are performed for the VM-entry MSR-load address if the VM-entry MSR-load count field is non-zero:
 - The lower 4 bits of the VM-entry MSR-load address must be 0. The address should not set any bits beyond the processor's physical-address width.¹

1. Software can determine a processor's physical-address width by executing CPUID with 80000008H in EAX. The physical-address width is returned in bits 7:0 of EAX.

- The address of the last byte in the VM-entry MSR-load area should not set any bits beyond the processor's physical-address width. The address of this last byte is VM-entry MSR-load address + (MSR count * 16) – 1. (The arithmetic used for the computation uses more bits than the processor's physical-address width.)

If IA32_VMX_BASIC[48] is read as 1, neither address should set any bits in the range 63:32; see Appendix A.1.

- If the processor is not in SMM, the "entry to SMM" and "deactivate dual-monitor treatment" VM-entry controls must be 0.
- The "entry to SMM" and "deactivate dual-monitor treatment" VM-entry controls cannot both be 1.

27.2.2 Checks on Host Control Registers, MSRs, and SSP

The following checks are performed on fields in the host-state area that correspond to control registers and MSRs:

- The CR0 field must not set any bit to a value not supported in VMX operation (see Section 24.8).¹
- The CR4 field must not set any bit to a value not supported in VMX operation (see Section 24.8).
- If bit 23 in the CR4 field (corresponding to CET) is 1, bit 16 in the CR0 field (WP) must also be 1.
- On processors that support Intel 64 architecture, the CR3 field must be such that bits 63:52 and bits in the range 51:32 beyond the processor's physical-address width must be 0.^{2,3}
- On processors that support Intel 64 architecture, the IA32_SYSENTER_ESP field and the IA32_SYSENTER_EIP field must each contain a canonical address.
- If the "load IA32_PERF_GLOBAL_CTRL" VM-exit control is 1, bits reserved in the IA32_PERF_GLOBAL_CTRL MSR must be 0 in the field for that register (see Figure 20-3).
- If the "load IA32_PAT" VM-exit control is 1, the value of the field for the IA32_PAT MSR must be one that could be written by WRMSR without fault at CPL 0. Specifically, each of the 8 bytes in the field must have one of the values 0 (UC), 1 (WC), 4 (WT), 5 (WP), 6 (WB), or 7 (UC-).
- If the "load IA32_EFER" VM-exit control is 1, bits reserved in the IA32_EFER MSR must be 0 in the field for that register. In addition, the values of the LMA and LME bits in the field must each be that of the "host address-space size" VM-exit control.
- If the "load CET state" VM-exit control is 1, the IA32_S_CET field must not set any bits reserved in the IA32_S_CET MSR, and bit 10 (corresponding to SUPPRESS) and bit 11 (TRACKER) in the field cannot both be set.
- If the "load CET state" VM-exit control is 1, bits 1:0 must be 0 in the SSP field.
- If the "load PKRS" VM-exit control is 1, bits 63:32 must be 0 in the IA32_PKRS field.

27.2.3 Checks on Host Segment and Descriptor-Table Registers

The following checks are performed on fields in the host-state area that correspond to segment and descriptor-table registers:

- In the selector field for each of CS, SS, DS, ES, FS, GS, and TR, the RPL (bits 1:0) and the TI flag (bit 2) must be 0.
- The selector fields for CS and TR cannot be 0000H.
- The selector field for SS cannot be 0000H if the "host address-space size" VM-exit control is 0.
- On processors that support Intel 64 architecture, the base-address fields for FS, GS, GDTR, IDTR, and TR must contain canonical addresses.

1. The bits corresponding to CR0.NW (bit 29) and CR0.CD (bit 30) are never checked because the values of these bits are not changed by VM exit; see Section 28.5.1.
2. Software can determine a processor's physical-address width by executing CPUID with 80000008H in EAX. The physical-address width is returned in bits 7:0 of EAX.
3. Bit 63 of the CR3 field in the host-state area must be 0. This is true even though, if CR4.PCIDE = 1, bit 63 of the source operand to MOV to CR3 is used to determine whether cached translation information is invalidated.

27.2.4 Checks Related to Address-Space Size

On processors that support Intel 64 architecture, the following checks related to address-space size are performed on VMX controls and fields in the host-state area:

- If the logical processor is outside IA-32e mode (if IA32_EFER.LMA = 0) at the time of VM entry, the following must hold:
 - The “IA-32e mode guest” VM-entry control is 0.
 - The “host address-space size” VM-exit control is 0.
- If the logical processor is in IA-32e mode (if IA32_EFER.LMA = 1) at the time of VM entry, the “host address-space size” VM-exit control must be 1.
- If the “host address-space size” VM-exit control is 0, the following must hold:
 - The “IA-32e mode guest” VM-entry control is 0.
 - Bit 17 of the CR4 field (corresponding to CR4.PCIDE) is 0.
 - Bits 63:32 in the RIP field are 0.
 - If the “load CET state” VM-exit control is 1, bits 63:32 in the IA32_S_CET field and in the SSP field are 0.
- If the “host address-space size” VM-exit control is 1, the following must hold:
 - Bit 5 of the CR4 field (corresponding to CR4.PAE) is 1.
 - The RIP field contains a canonical address.
 - If the “load CET state” VM-exit control is 1, the IA32_S_CET field and the SSP field contain canonical addresses.
- If the “load CET state” VM-exit control is 1, the IA32_INTERRUPT_SSP_TABLE_ADDR field contains a canonical address.

On processors that do not support Intel 64 architecture, checks are performed to ensure that the “IA-32e mode guest” VM-entry control and the “host address-space size” VM-exit control are both 0.

27.3 CHECKING AND LOADING GUEST STATE

If all checks on the VMX controls and the host-state area pass (see Section 27.2), the following operations take place concurrently: (1) the guest-state area of the VMCS is checked to ensure that, after the VM entry completes, the state of the logical processor is consistent with IA-32 and Intel 64 architectures; (2) processor state is loaded from the guest-state area or as specified by the VM-entry control fields; and (3) address-range monitoring is cleared.

Because the checking and the loading occur concurrently, a failure may be discovered only after some state has been loaded. For this reason, the logical processor responds to such failures by loading state from the host-state area, as it would for a VM exit. See Section 27.8.

27.3.1 Checks on the Guest State Area

This section describes checks performed on fields in the guest-state area. These checks may be performed in any order. Some checks prevent establishment of settings (or combinations of settings) that are currently reserved. Future processors may allow such settings (or combinations) and may not perform the corresponding checks. The correctness of software should not rely on VM-entry failures resulting from the checks documented in this section.

The following subsections reference fields that correspond to processor state. Unless otherwise stated, these references are to fields in the guest-state area.

27.3.1.1 Checks on Guest Control Registers, Debug Registers, and MSRs

The following checks are performed on fields in the guest-state area corresponding to control registers, debug registers, and MSRs:

- The CR0 field must not set any bit to a value not supported in VMX operation (see Section 24.8). The following are exceptions:
 - Bit 0 (corresponding to CR0.PE) and bit 31 (PG) are not checked if the “unrestricted guest” VM-execution control is 1.¹
 - Bit 29 (corresponding to CR0.NW) and bit 30 (CD) are never checked because the values of these bits are not changed by VM entry; see Section 27.3.2.1.
- If bit 31 in the CR0 field (corresponding to PG) is 1, bit 0 in that field (PE) must also be 1.²
- The CR4 field must not set any bit to a value not supported in VMX operation (see Section 24.8).
- If bit 23 in the CR4 field (corresponding to CET) is 1, bit 16 in the CR0 field (WP) must also be 1.
- If the “load debug controls” VM-entry control is 1, bits reserved in the IA32_DEBUGCTL MSR must be 0 in the field for that register. The first processors to support the virtual-machine extensions supported only the 1-setting of this control and thus performed this check unconditionally.
- The following checks are performed on processors that support Intel 64 architecture:
 - If the “IA-32e mode guest” VM-entry control is 1, bit 31 in the CR0 field (corresponding to CR0.PG) and bit 5 in the CR4 field (corresponding to CR4.PAE) must each be 1.³
 - If the “IA-32e mode guest” VM-entry control is 0, bit 17 in the CR4 field (corresponding to CR4.PCIDE) must be 0.
 - The CR3 field must be such that bits 63:52 and bits in the range 51:32 beyond the processor’s physical-address width are 0.^{4,5}
 - If the “load debug controls” VM-entry control is 1, bits 63:32 in the DR7 field must be 0. The first processors to support the virtual-machine extensions supported only the 1-setting of this control and thus performed this check unconditionally (if they supported Intel 64 architecture).
 - The IA32_SYSENTER_ESP field and the IA32_SYSENTER_EIP field must each contain a canonical address.
 - If the “load CET state” VM-entry control is 1, the IA32_S_CET field and the IA32_INTERRUPT_SSP_TABLE_ADDR field must contain canonical addresses.
- If the “load IA32_PERF_GLOBAL_CTRL” VM-entry control is 1, bits reserved in the IA32_PERF_GLOBAL_CTRL MSR must be 0 in the field for that register (see Figure 20-3).
- If the “load IA32_PAT” VM-entry control is 1, the value of the field for the IA32_PAT MSR must be one that could be written by WRMSR without fault at CPL 0. Specifically, each of the 8 bytes in the field must have one of the values 0 (UC), 1 (WC), 4 (WT), 5 (WP), 6 (WB), or 7 (UC-).
- If the “load IA32_EFER” VM-entry control is 1, the following checks are performed on the field for the IA32_EFER MSR:
 - Bits reserved in the IA32_EFER MSR must be 0.
 - Bit 10 (corresponding to IA32_EFER.LMA) must equal the value of the “IA-32e mode guest” VM-entry control. It must also be identical to bit 8 (LME) if bit 31 in the CR0 field (corresponding to CR0.PG) is 1.⁶

-
1. “Unrestricted guest” is a secondary processor-based VM-execution control. If bit 31 of the primary processor-based VM-execution controls is 0, VM entry functions as if the “unrestricted guest” VM-execution control were 0. See Section 25.6.2.
 2. If the capability MSR IA32_VMX_CRO_FIXED0 reports that CR0.PE must be 1 in VMX operation, bit 0 in the CR0 field must be 1 unless the “unrestricted guest” VM-execution control and bit 31 of the primary processor-based VM-execution controls are both 1.
 3. If the capability MSR IA32_VMX_CRO_FIXED0 reports that CR0.PG must be 1 in VMX operation, bit 31 in the CR0 field must be 1 unless the “unrestricted guest” VM-execution control and bit 31 of the primary processor-based VM-execution controls are both 1.
 4. Software can determine a processor’s physical-address width by executing CPUID with 80000008H in EAX. The physical-address width is returned in bits 7:0 of EAX.
 5. Bit 63 of the CR3 field in the guest-state area must be 0. This is true even though, if CR4.PCIDE = 1, bit 63 of the source operand to MOV to CR3 is used to determine whether cached translation information is invalidated.
 6. If the capability MSR IA32_VMX_CRO_FIXED0 reports that CR0.PG must be 1 in VMX operation, bit 31 in the CR0 field must be 1 unless the “unrestricted guest” VM-execution control and bit 31 of the primary processor-based VM-execution controls are both 1.

- If the “load IA32_BNDCFGS” VM-entry control is 1, the following checks are performed on the field for the IA32_BNDCFGS MSR:
 - Bits reserved in the IA32_BNDCFGS MSR must be 0.
 - The linear address in bits 63:12 must be canonical.
- If the “load IA32_RTIT_CTL” VM-entry control is 1, bits reserved in the IA32_RTIT_CTL MSR must be 0 in the field for that register (see Table 33-6).
- If the “load CET state” VM-entry control is 1, the IA32_S_CET field must not set any bits reserved in the IA32_S_CET MSR, and bit 10 (corresponding to SUPPRESS) and bit 11 (TRACKER) of the field cannot both be set.
- If the “load guest IA32_LBR_CTL” VM-entry control is 1, bits reserved in the IA32_LBR_CTL MSR must be 0 in the field for that register.
- If the “load PKRS” VM-entry control is 1, bits 63:32 must be 0 in the IA32_PKRS field.
- If the “load UINV” VM-entry control is 1, bits 15:8 must be 0 in the guest UINV field.

27.3.1.2 Checks on Guest Segment Registers

This section specifies the checks on the fields for CS, SS, DS, ES, FS, GS, TR, and LDTR. The following terms are used in defining these checks:

- The guest will be **virtual-8086** if the VM flag (bit 17) is 1 in the RFLAGS field in the guest-state area.
- The guest will be **IA-32e mode** if the “IA-32e mode guest” VM-entry control is 1. (This is possible only on processors that support Intel 64 architecture.)
- Any one of these registers is said to be **usable** if the unusable bit (bit 16) is 0 in the access-rights field for that register.

The following are the checks on these fields:

- Selector fields.
 - TR. The TI flag (bit 2) must be 0.
 - LDTR. If LDTR is usable, the TI flag (bit 2) must be 0.
 - SS. If the guest will not be virtual-8086 and the “unrestricted guest” VM-execution control is 0, the RPL (bits 1:0) must equal the RPL of the selector field for CS.¹
- Base-address fields.
 - CS, SS, DS, ES, FS, GS. If the guest will be virtual-8086, the address must be the selector field shifted left 4 bits (multiplied by 16).
 - The following checks are performed on processors that support Intel 64 architecture:
 - TR, FS, GS. The address must be canonical.
 - LDTR. If LDTR is usable, the address must be canonical.
 - CS. Bits 63:32 of the address must be zero.
 - SS, DS, ES. If the register is usable, bits 63:32 of the address must be zero.
- Limit fields for CS, SS, DS, ES, FS, GS. If the guest will be virtual-8086, the field must be 0000FFFFH.
- Access-rights fields.
 - CS, SS, DS, ES, FS, GS.
 - If the guest will be virtual-8086, the field must be 000000F3H. This implies the following:
 - Bits 3:0 (Type) must be 3, indicating an expand-up read/write accessed data segment.
 - Bit 4 (S) must be 1.

1. “Unrestricted guest” is a secondary processor-based VM-execution control. If bit 31 of the primary processor-based VM-execution controls is 0, VM entry functions as if the “unrestricted guest” VM-execution control were 0. See Section 25.6.2.

- Bits 6:5 (DPL) must be 3.
- Bit 7 (P) must be 1.
- Bits 11:8 (reserved), bit 12 (software available), bit 13 (reserved/L), bit 14 (D/B), bit 15 (G), bit 16 (unusable), and bits 31:17 (reserved) must all be 0.
- If the guest will not be virtual-8086, the different sub-fields are considered separately:
 - Bits 3:0 (Type).
 - CS. The values allowed depend on the setting of the “unrestricted guest” VM-execution control:
 - If the control is 0, the Type must be 9, 11, 13, or 15 (accessed code segment).
 - If the control is 1, the Type must be either 3 (read/write accessed expand-up data segment) or one of 9, 11, 13, and 15 (accessed code segment).
 - SS. If SS is usable, the Type must be 3 or 7 (read/write, accessed data segment).
 - DS, ES, FS, GS. The following checks apply if the register is usable:
 - Bit 0 of the Type must be 1 (accessed).
 - If bit 3 of the Type is 1 (code segment), then bit 1 of the Type must be 1 (readable).
 - Bit 4 (S). If the register is CS or if the register is usable, S must be 1.
 - Bits 6:5 (DPL).
 - CS.
 - If the Type is 3 (read/write accessed expand-up data segment), the DPL must be 0. The Type can be 3 only if the “unrestricted guest” VM-execution control is 1.
 - If the Type is 9 or 11 (non-conforming code segment), the DPL must equal the DPL in the access-rights field for SS.
 - If the Type is 13 or 15 (conforming code segment), the DPL cannot be greater than the DPL in the access-rights field for SS.
 - SS.
 - If the “unrestricted guest” VM-execution control is 0, the DPL must equal the RPL from the selector field.
 - The DPL must be 0 either if the Type in the access-rights field for CS is 3 (read/write accessed expand-up data segment) or if bit 0 in the CR0 field (corresponding to CR0.PE) is 0.¹
 - DS, ES, FS, GS. The DPL cannot be less than the RPL in the selector field if (1) the “unrestricted guest” VM-execution control is 0; (2) the register is usable; and (3) the Type in the access-rights field is in the range 0 – 11 (data segment or non-conforming code segment).
 - Bit 7 (P). If the register is CS or if the register is usable, P must be 1.
 - Bits 11:8 (reserved). If the register is CS or if the register is usable, these bits must all be 0.
 - Bit 14 (D/B). For CS, D/B must be 0 if the guest will be IA-32e mode and the L bit (bit 13) in the access-rights field is 1.
 - Bit 15 (G). The following checks apply if the register is CS or if the register is usable:
 - If any bit in the limit field in the range 11:0 is 0, G must be 0.
 - If any bit in the limit field in the range 31:20 is 1, G must be 1.
 - Bits 31:17 (reserved). If the register is CS or if the register is usable, these bits must all be 0.

1. The following apply if either the “unrestricted guest” VM-execution control or bit 31 of the primary processor-based VM-execution controls is 0: (1) bit 0 in the CR0 field must be 1 if the capability MSR IA32_VMX_CR0_FIXED0 reports that CR0.PE must be 1 in VMX operation; and (2) the Type in the access-rights field for CS cannot be 3.

- TR. The different sub-fields are considered separately:
 - Bits 3:0 (Type).
 - If the guest will not be IA-32e mode, the Type must be 3 (16-bit busy TSS) or 11 (32-bit busy TSS).
 - If the guest will be IA-32e mode, the Type must be 11 (64-bit busy TSS).
 - Bit 4 (S). S must be 0.
 - Bit 7 (P). P must be 1.
 - Bits 11:8 (reserved). These bits must all be 0.
 - Bit 15 (G).
 - If any bit in the limit field in the range 11:0 is 0, G must be 0.
 - If any bit in the limit field in the range 31:20 is 1, G must be 1.
 - Bit 16 (Unusable). The unusable bit must be 0.
 - Bits 31:17 (reserved). These bits must all be 0.
- LDTR. The following checks on the different sub-fields apply only if LDTR is usable:
 - Bits 3:0 (Type). The Type must be 2 (LDT).
 - Bit 4 (S). S must be 0.
 - Bit 7 (P). P must be 1.
 - Bits 11:8 (reserved). These bits must all be 0.
 - Bit 15 (G).
 - If any bit in the limit field in the range 11:0 is 0, G must be 0.
 - If any bit in the limit field in the range 31:20 is 1, G must be 1.
 - Bits 31:17 (reserved). These bits must all be 0.

27.3.1.3 Checks on Guest Descriptor-Table Registers

The following checks are performed on the fields for GDTR and IDTR:

- On processors that support Intel 64 architecture, the base-address fields must contain canonical addresses.
- Bits 31:16 of each limit field must be 0.

27.3.1.4 Checks on Guest RIP, RFLAGS, and SSP

The following checks are performed on fields in the guest-state area corresponding to RIP, RFLAGS, and SSP (shadow-stack pointer):

- RIP. The following checks are performed on processors that support Intel 64 architecture:
 - Bits 63:32 must be 0 if the “IA-32e mode guest” VM-entry control is 0 or if the L bit (bit 13) in the access-rights field for CS is 0.
 - If the processor supports $N < 64$ linear-address bits, bits 63:N must be identical if the “IA-32e mode guest” VM-entry control is 1 and the L bit in the access-rights field for CS is 1.¹ (No check applies if the processor supports 64 linear-address bits.) The guest RIP value is not required to be canonical; the value of bit N-1 may differ from that of bit N.
- RFLAGS.
 - Reserved bits 63:22 (bits 31:22 on processors that do not support Intel 64 architecture), bit 15, bit 5 and bit 3 must be 0 in the field, and reserved bit 1 must be 1.

1. Software can determine the number N by executing CPUID with 80000008H in EAX. The number of linear-address bits supported is returned in bits 15:8 of EAX.

- The VM flag (bit 17) must be 0 either if the “IA-32e mode guest” VM-entry control is 1 or if bit 0 in the CR0 field (corresponding to CR0.PE) is 0.¹
- The IF flag (RFLAGS[bit 9]) must be 1 if the valid bit (bit 31) in the VM-entry interruption-information field is 1 and the interruption type (bits 10:8) is external interrupt.
- SSP. The following checks are performed if the “load CET state” VM-entry control is 1
 - Bits 1:0 must be 0.
 - If the processor supports the Intel 64 architecture, bits 63:N must be identical, where N is the CPU’s maximum linear-address width. (This check does not apply if the processor supports 64 linear-address bits.) The guest SSP value is not required to be canonical; the value of bit N-1 may differ from that of bit N.

27.3.1.5 Checks on Guest Non-Register State

The following checks are performed on fields in the guest-state area corresponding to non-register state:

- Activity state.
 - The activity-state field must contain a value in the range 0 – 3, indicating an activity state supported by the implementation (see Section 25.4.2). Future processors may include support for other activity states. Software should read the VMX capability MSR IA32_VMX_MISC (see Appendix A.6) to determine what activity states are supported.
 - The activity-state field must not indicate the HLT state if the DPL (bits 6:5) in the access-rights field for SS is not 0.²
 - The activity-state field must indicate the active state if the interruptibility-state field indicates blocking by either MOV-SS or by STI (if either bit 0 or bit 1 in that field is 1).
 - If the valid bit (bit 31) in the VM-entry interruption-information field is 1, the interruption to be delivered (as defined by interruption type and vector) must not be one that would normally be blocked while a logical processor is in the activity state corresponding to the contents of the activity-state field. The following items enumerate the interruptions (as specified in the VM-entry interruption-information field) whose injection is allowed for the different activity states:
 - Active. Any interruption is allowed.
 - HLT. The only events allowed are the following:
 - Those with interruption type external interrupt or non-maskable interrupt (NMI).
 - Those with interruption type hardware exception and vector 1 (debug exception) or vector 18 (machine-check exception).
 - Those with interruption type other event and vector 0 (pending MTF VM exit).
 See Table 25-17 in Section 25.8.3 for details regarding the format of the VM-entry interruption-information field.
 - Shutdown. Only NMIs and machine-check exceptions are allowed.
 - Wait-for-SIPI. No interruptions are allowed.
 - The activity-state field must not indicate the wait-for-SIPI state if the “entry to SMM” VM-entry control is 1.
- Interruptibility state.
 - The reserved bits (bits 31:5) must be 0.
 - The field cannot indicate blocking by both STI and MOV SS (bits 0 and 1 cannot both be 1).
 - Bit 0 (blocking by STI) must be 0 if the IF flag (bit 9) is 0 in the RFLAGS field.

1. If the capability MSR IA32_VMX_CR0_FIXED0 reports that CR0.PE must be 1 in VMX operation, bit 0 in the CR0 field must be 1 unless the “unrestricted guest” VM-execution control and bit 31 of the primary processor-based VM-execution controls are both 1.

2. As noted in Section 25.4.1, SS.DPL corresponds to the logical processor’s current privilege level (CPL).

- Bit 0 (blocking by STI) and bit 1 (blocking by MOV-SS) must both be 0 if the valid bit (bit 31) in the VM-entry interruption-information field is 1 and the interruption type (bits 10:8) in that field has value 0, indicating external interrupt, or value 2, indicating non-maskable interrupt (NMI).
- Bit 2 (blocking by SMI) must be 0 if the processor is not in SMM.
- Bit 2 (blocking by SMI) must be 1 if the “entry to SMM” VM-entry control is 1.
- Bit 3 (blocking by NMI) must be 0 if the “virtual NMIs” VM-execution control is 1, the valid bit (bit 31) in the VM-entry interruption-information field is 1, and the interruption type (bits 10:8) in that field has value 2 (indicating NMI).
- If bit 4 (enclave interruption) is 1, bit 1 (blocking by MOV-SS) must be 0 and the processor must support for SGX by enumerating CPUID.(EAX=07H,ECX=0):EBX.SGX[bit 2] as 1.

NOTE

If the “virtual NMIs” VM-execution control is 0, there is no requirement that bit 3 be 0 if the valid bit in the VM-entry interruption-information field is 1 and the interruption type in that field has value 2.

- Pending debug exceptions.
 - Bits 11:4, bit 13, bit 15, and bits 63:17 (bits 31:17 on processors that do not support Intel 64 architecture) must be 0.
 - The following checks are performed if any of the following holds: (1) the interruptibility-state field indicates blocking by STI (bit 0 in that field is 1); (2) the interruptibility-state field indicates blocking by MOV SS (bit 1 in that field is 1); or (3) the activity-state field indicates HLT:
 - Bit 14 (BS) must be 1 if the TF flag (bit 8) in the RFLAGS field is 1 and the BTF flag (bit 1) in the IA32_DEBUGCTL field is 0.
 - Bit 14 (BS) must be 0 if the TF flag (bit 8) in the RFLAGS field is 0 or the BTF flag (bit 1) in the IA32_DEBUGCTL field is 1.
 - The following checks are performed if bit 16 (RTM) is 1:
 - Bits 11:0, bits 15:13, and bits 63:17 (bits 31:17 on processors that do not support Intel 64 architecture) must be 0; bit 12 must be 1.
 - The processor must support for RTM by enumerating CPUID.(EAX=07H,ECX=0):EBX[bit 11] as 1.
 - The interruptibility-state field must not indicate blocking by MOV SS (bit 1 in that field must be 0).
- VMCS link pointer. The following checks apply if the field contains a value other than FFFFFFFF_FFFFFFFFH:
 - Bits 11:0 must be 0.
 - Bits beyond the processor’s physical-address width must be 0.^{1,2}
 - The 4 bytes located in memory referenced by the value of the field (as a physical address) must satisfy the following:
 - Bits 30:0 must contain the processor’s VMCS revision identifier (see Section 25.2).³
 - Bit 31 must contain the setting of the “VMCS shadowing” VM-execution control.⁴ This implies that the referenced VMCS is a shadow VMCS (see Section 25.10) if and only if the “VMCS shadowing” VM-execution control is 1.

1. Software can determine a processor’s physical-address width by executing CPUID with 80000008H in EAX. The physical-address width is returned in bits 7:0 of EAX.

2. If IA32_VMX_BASIC[48] is read as 1, this field must not set any bits in the range 63:32; see Appendix A.1.

3. Earlier versions of this manual specified that the VMCS revision identifier was a 32-bit field. For all processors produced prior to this change, bit 31 of the VMCS revision identifier was 0.

4. “VMCS shadowing” is a secondary processor-based VM-execution control. If bit 31 of the primary processor-based VM-execution controls is 0, VM entry functions as if the “VMCS shadowing” VM-execution control were 0. See Section 25.6.2.

- If the processor is not in SMM or the “entry to SMM” VM-entry control is 1, the field must not contain the current VMCS pointer.
- If the processor is in SMM and the “entry to SMM” VM-entry control is 0, the field must differ from the executive-VMCS pointer.

27.3.1.6 Checks on Guest Page-Directory-Pointer-Table Entries

If CR0.PG = 1, CR4.PAE = 1, and IA32_EFER.LME = 0, the logical processor uses **PAE paging** (see Section 4.4 in the Intel® 64 and IA-32 Architectures Software Developer’s Manual, Volume 3A).¹ When PAE paging is in use, the physical address in CR3 references a table of **page-directory-pointer-table entries** (PDPTEs). A MOV to CR3 when PAE paging is in use checks the validity of the PDPTEs.

A VM entry is to a guest that uses PAE paging if (1) bit 31 (corresponding to CR0.PG) is set in the CR0 field in the guest-state area; (2) bit 5 (corresponding to CR4.PAE) is set in the CR4 field; and (3) the “IA-32e mode guest” VM-entry control is 0. Such a VM entry checks the validity of the PDPTEs:

- If the “enable EPT” VM-execution control is 0, VM entry checks the validity of the PDPTEs referenced by the CR3 field in the guest-state area if either (1) PAE paging was not in use before the VM entry; or (2) the value of CR3 is changing as a result of the VM entry. VM entry may check their validity even if neither (1) nor (2) hold.²
- If the “enable EPT” VM-execution control is 1, VM entry checks the validity of the PDPTe fields in the guest-state area (see Section 25.4.2).

A VM entry to a guest that does not use PAE paging does not check the validity of any PDPTEs.

A VM entry that checks the validity of the PDPTEs uses the same checks that are used when CR3 is loaded with MOV to CR3 when PAE paging is in use.³ If MOV to CR3 would cause a general-protection exception due to the PDPTEs that would be loaded (e.g., because a reserved bit is set), the VM entry fails.

27.3.2 Loading Guest State

Processor state is updated on VM entries in the following ways:

- Some state is loaded from the guest-state area.
- Some state is determined by VM-entry controls.
- The page-directory pointers are loaded based on the values of certain control registers.

This loading may be performed in any order and in parallel with the checking of VMCS contents (see Section 27.3.1).

The loading of guest state is detailed in Section 27.3.2.1 to Section 27.3.2.4. These sections reference VMCS fields that correspond to processor state. Unless otherwise stated, these references are to fields in the guest-state area.

In addition to the state loading described in this section, VM entries may load MSRs from the VM-entry MSR-load area (see Section 27.4). This loading occurs only after the state loading described in this section and the checking of VMCS contents described in Section 27.3.1.

27.3.2.1 Loading Guest Control Registers, Debug Registers, and MSRs

The following items describe how guest control registers, debug registers, and MSRs are loaded on VM entry:

-
1. On processors that support Intel 64 architecture, the physical-address extension may support more than 36 physical-address bits. Software can determine the number physical-address bits supported by executing CPUID with 80000008H in EAX. The physical-address width is returned in bits 7:0 of EAX.
 2. “Enable EPT” is a secondary processor-based VM-execution control. If bit 31 of the primary processor-based VM-execution controls is 0, VM entry functions as if the “enable EPT” VM-execution control were 0. See Section 25.6.2.
 3. This implies that (1) bits 11:9 in each PDPTe are ignored; and (2) if bit 0 (present) is clear in one of the PDPTEs, bits 63:1 of that PDPTe are ignored.

- CR0 is loaded from the CR0 field with the exception of the following bits, which are never modified on VM entry: ET (bit 4); reserved bits 15:6, 17, and 28:19; NW (bit 29) and CD (bit 30).¹ The values of these bits in the CR0 field are ignored.
- CR3 and CR4 are loaded from the CR3 field and the CR4 field, respectively.
- If the “load debug controls” VM-entry control is 1, DR7 is loaded from the DR7 field with the exception that bit 12 and bits 15:14 are always 0 and bit 10 is always 1. The values of these bits in the DR7 field are ignored. The first processors to support the virtual-machine extensions supported only the 1-setting of the “load debug controls” VM-entry control and thus always loaded DR7 from the DR7 field.
- The following describes how certain MSRs are loaded using fields in the guest-state area:
 - If the “load debug controls” VM-entry control is 1, the IA32_DEBUGCTL MSR is loaded from the IA32_DEBUGCTL field. The first processors to support the virtual-machine extensions supported only the 1-setting of this control and thus always loaded the IA32_DEBUGCTL MSR from the IA32_DEBUGCTL field.
 - The IA32_SYSENTER_CS MSR is loaded from the IA32_SYSENTER_CS field. Since this field has only 32 bits, bits 63:32 of the MSR are cleared to 0.
 - The IA32_SYSENTER_ESP and IA32_SYSENTER_EIP MSRs are loaded from the IA32_SYSENTER_ESP field and the IA32_SYSENTER_EIP field, respectively. On processors that do not support Intel 64 architecture, these fields have only 32 bits; bits 63:32 of the MSRs are cleared to 0.
 - The following are performed on processors that support Intel 64 architecture:
 - The MSRs FS.base and GS.base are loaded from the base-address fields for FS and GS, respectively (see Section 27.3.2.2).
 - If the “load IA32_EFER” VM-entry control is 0, bits in the IA32_EFER MSR are modified as follows:
 - IA32_EFER.LMA is loaded with the setting of the “IA-32e mode guest” VM-entry control.
 - If CR0 is being loaded so that CR0.PG = 1, IA32_EFER.LME is also loaded with the setting of the “IA-32e mode guest” VM-entry control.² Otherwise, IA32_EFER.LME is unmodified.
 - See below for the case in which the “load IA32_EFER” VM-entry control is 1
 - If the “load IA32_PERF_GLOBAL_CTRL” VM-entry control is 1, the IA32_PERF_GLOBAL_CTRL MSR is loaded from the IA32_PERF_GLOBAL_CTRL field.
 - If the “load IA32_PAT” VM-entry control is 1, the IA32_PAT MSR is loaded from the IA32_PAT field.
 - If the “load IA32_EFER” VM-entry control is 1, the IA32_EFER MSR is loaded from the IA32_EFER field.
 - If the “load IA32_BNDCFGS” VM-entry control is 1, the IA32_BNDCFGS MSR is loaded from the IA32_BNDCFGS field.
 - If the “load IA32_RTIT_CTL” VM-entry control is 1, the IA32_RTIT_CTL MSR is loaded from the IA32_RTIT_CTL field.
 - If the “load CET” VM-entry control is 1, the IA32_S_CET and IA32_INTERRUPT_SSP_TABLE_ADDR MSRs are loaded from the IA32_S_CET field and the IA32_INTERRUPT_SSP_TABLE_ADDR field, respectively. On processors that do not support Intel 64 architecture, these fields have only 32 bits; bits 63:32 of the MSRs are cleared to 0.
 - If the “load guest IA32_LBR_CTL” VM-entry control is 1, the IA32_LBR_CTL MSR is loaded from the IA32_LBR_CTL guest state field.
 - If the “load PKRS” VM-entry control is 1, the IA32_PKRS MSR is loaded from the IA32_PKRS field.

With the exception of FS.base and GS.base, any of these MSRs is subsequently overwritten if it appears in the VM-entry MSR-load area. See Section 27.4.

-
1. Bits 15:6, bit 17, and bit 28:19 of CR0 and CR0.ET are unchanged by executions of MOV to CR0. Bits 15:6, bit 17, and bit 28:19 of CR0 are always 0 and CR0.ET is always 1.
 2. If the capability MSR IA32_VMX_CR0_FIXED0 reports that CR0.PG must be 1 in VMX operation, VM entry must be loading CR0 so that CR0.PG = 1 unless the “unrestricted guest” VM-execution control and bit 31 of the primary processor-based VM-execution controls are both 1.

- The SMBASE register is unmodified by all VM entries except those that return from SMM.

27.3.2.2 Loading Guest Segment Registers and Descriptor-Table Registers

For each of CS, SS, DS, ES, FS, GS, TR, and LDTR, fields are loaded from the guest-state area as follows:

- The unusable bit is loaded from the access-rights field. This bit can never be set for TR (see Section 27.3.1.2). If it is set for one of the other registers, the following apply:
 - For each of CS, SS, DS, ES, FS, and GS, uses of the segment cause faults (general-protection exception or stack-fault exception) outside 64-bit mode, just as they would had the segment been loaded using a null selector. This bit does not cause accesses to fault in 64-bit mode.
 - If this bit is set for LDTR, uses of LDTR cause general-protection exceptions in all modes, just as they would had LDTR been loaded using a null selector.

If this bit is clear for any of CS, SS, DS, ES, FS, GS, TR, and LDTR, a null selector value does not cause a fault (general-protection exception or stack-fault exception).
- TR. The selector, base, limit, and access-rights fields are loaded.
- CS.
 - The following fields are always loaded: selector, base address, limit, and (from the access-rights field) the L, D, and G bits.
 - For the other fields, the unusable bit of the access-rights field is consulted:
 - If the unusable bit is 0, all of the access-rights field is loaded.
 - If the unusable bit is 1, the remainder of CS access rights are undefined after VM entry.
- SS, DS, ES, FS, GS, and LDTR.
 - The selector fields are loaded.
 - For the other fields, the unusable bit of the corresponding access-rights field is consulted:
 - If the unusable bit is 0, the base-address, limit, and access-rights fields are loaded.
 - If the unusable bit is 1, the base address, the segment limit, and the remainder of the access rights are undefined after VM entry with the following exceptions:
 - Bits 3:0 of the base address for SS are cleared to 0.
 - SS.DPL is always loaded from the SS access-rights field. This will be the current privilege level (CPL) after the VM entry completes.
 - SS.B is always set to 1.
 - The base addresses for FS and GS are loaded from the corresponding fields in the VMCS. On processors that support Intel 64 architecture, the values loaded for base addresses for FS and GS are also manifest in the FS.base and GS.base MSRs.
 - On processors that support Intel 64 architecture, the base address for LDTR is set to an undefined but canonical value.
 - On processors that support Intel 64 architecture, bits 63:32 of the base addresses for SS, DS, and ES are cleared to 0.

GDTR and IDTR are loaded using the base and limit fields.

27.3.2.3 Loading Guest RIP, RSP, RFLAGS, and SSP

RSP, RIP, and RFLAGS are loaded from the RSP field, the RIP field, and the RFLAGS field, respectively.

If the “load CET” VM-entry control is 1, SSP (shadow-stack pointer) is loaded from the SSP field.

The following items regard the upper 32 bits of these fields on VM entries that are not to 64-bit mode:

- Bits 63:32 of RSP are undefined outside 64-bit mode. Thus, a logical processor may ignore the contents of bits 63:32 of the RSP field on VM entries that are not to 64-bit mode.

- As noted in Section 27.3.1.4, bits 63:32 of the RIP and RFLAGS fields must be 0 on VM entries that are not to 64-bit mode. (The same is true for SSP for VM entries that are not to 64-bit mode when the “load CET” VM-entry control is 1.)

27.3.2.4 Loading Page-Directory-Pointer-Table Entries

As noted in Section 27.3.1.6, the logical processor uses PAE paging if CR0.PG = 1, CR4.PAE = 1, and IA32_EFER.LME = 0. A VM entry to a guest that uses PAE paging loads the PDPTEs into internal, non-architectural registers based on the setting of the “enable EPT” VM-execution control:

- If the control is 0, the PDPTEs are loaded from the page-directory-pointer table referenced by the physical address in the value of CR3 being loaded by the VM entry (see Section 27.3.2.1). The values loaded are treated as physical addresses in VMX non-root operation.
- If the control is 1, the PDPTEs are loaded from corresponding fields in the guest-state area (see Section 25.4.2). The values loaded are treated as guest-physical addresses in VMX non-root operation.

27.3.2.5 Updating Non-Register State

Section 29.4 describes how the VMX architecture controls how a logical processor manages information in the TLBs and paging-structure caches. The following items detail how VM entries invalidate cached mappings:

- If the “enable VPID” VM-execution control is 0, the logical processor invalidates linear mappings and combined mappings associated with VPID 0000H (for all PCIDs); combined mappings for VPID 0000H are invalidated for all EPTRTA values (EPTRTA is the value of bits 51:12 of EPTP).
- VM entries are not required to invalidate any guest-physical mappings, nor are they required to invalidate any linear mappings or combined mappings if the “enable VPID” VM-execution control is 1.

If the “virtual-interrupt delivery” VM-execution control is 1, VM entry loads the values of RVI and SVI from the guest interrupt-status field in the VMCS (see Section 25.4.2). After doing so, the logical processor first causes PPR virtualization (Section 30.1.3) and then evaluates pending virtual interrupts (Section 30.2.1).

If a virtual interrupt is recognized, it may be delivered in VMX non-root operation immediately after VM entry (including any specified event injection) completes; see Section 27.7.5. See Section 30.2.2 for details regarding the delivery of virtual interrupts.

27.3.3 Clearing Address-Range Monitoring

The Intel 64 and IA-32 architectures allow software to monitor a specified address range using the MONITOR and MWAIT instructions. See Section 9.10.4 in the Intel® 64 and IA-32 Architectures Software Developer’s Manual, Volume 3A. VM entries clear any address-range monitoring that may be in effect.

27.4 LOADING MSRS

VM entries may load MSRs from the VM-entry MSR-load area (see Section 25.8.2). Specifically each entry in that area (up to the number specified in the VM-entry MSR-load count) is processed in order by loading the MSR indexed by bits 31:0 with the contents of bits 127:64 as they would be written by WRMSR.¹

Processing of an entry fails in any of the following cases:

- The value of bits 31:0 is either C0000100H (the IA32_FS_BASE MSR) or C0000101 (the IA32_GS_BASE MSR).
- The value of bits 31:8 is 000008H, meaning that the indexed MSR is one that allows access to an APIC register when the local APIC is in x2APIC mode.
- The value of bits 31:0 indicates an MSR that can be written only in system-management mode (SMM) and the VM entry did not commence in SMM. (IA32_SMM_MONITOR_CTL is an MSR that can be written only in SMM.)

1. Because attempts to modify the value of IA32_EFER.LMA by WRMSR are ignored, attempts to modify it using the VM-entry MSR-load area are also ignored.

- The value of bits 31:0 indicates an MSR that cannot be loaded on VM entries for model-specific reasons. A processor may prevent loading of certain MSRs even if they can normally be written by WRMSR. Such model-specific behavior is documented in Chapter 2, “Model-Specific Registers (MSRs),” in the Intel® 64 and IA-32 Architectures Software Developer’s Manual, Volume 4.
- Bits 63:32 are not all 0.
- An attempt to write bits 127:64 to the MSR indexed by bits 31:0 of the entry would cause a general-protection exception if executed via WRMSR with CPL = 0.¹

The VM entry fails if processing fails for any entry. The logical processor responds to such failures by loading state from the host-state area, as it would for a VM exit. See Section 27.8.

If any MSR is being loaded in such a way that would architecturally require a TLB flush, the TLBs are updated so that, after VM entry, the logical processor will not use any translations that were cached before the transition.

27.5 TRACE-ADDRESS PRE-TRANSLATION (TAPT)

When the “Intel PT uses guest physical addresses” VM-execution control is 1, the addresses used by Intel PT are treated as guest-physical addresses, and these are translated to physical addresses using EPT.

VM entry uses **trace-address pre-translation (TAPT)** to prevent buffered trace data from being lost due to an EPT violation; see Section 26.5.4.2. VM entry uses TAPT only if Intel PT will be enabled following VM entry (IA32_RTIT_CTL.TraceEn = 1) and only if the “Intel PT uses guest physical addresses” VM-execution control is 1

As noted in Section 26.5.4, TAPT may cause a VM exit due to an EPT violation, EPT misconfiguration, page-modification log-full event, or APIC access. If such a VM exit occurs as a result of TAPT during VM entry, the VM exit operates as if it had occurred in VMX non-root operation after the VM entry completed (in the guest context).

If TAPT during VM entry causes a VM exit, the VM entry does not perform event injection (Section 27.6), even if the valid bit in the VM-entry interruption-information field is 1. Such VM exits save the contents of VM-entry interruption-information and VM-entry exception error code fields into the IDT-vectoring information and IDT-vectoring error code fields, respectively.

27.6 EVENT INJECTION

If the valid bit in the VM-entry interruption-information field (see Section 25.8.3) is 1, VM entry causes an event to be delivered (or made pending) after all components of guest state have been loaded (including MSRs) and after the VM-execution control fields have been established.

- If the interruption type in the field is 0 (external interrupt), 2 (non-maskable interrupt); 3 (hardware exception), 4 (software interrupt), 5 (privileged software exception), or 6 (software exception), the event is delivered as described in Section 27.6.1.
- If the interruption type in the field is 7 (other event) and the vector field is 0, an MTF VM exit is pending after VM entry. See Section 27.6.2.

27.6.1 Vectored-Event Injection

VM entry delivers an injected vectored event within the guest context established by VM entry. This means that delivery occurs after all components of guest state have been loaded (including MSRs) and after the VM-execution

1. If CR0.PG = 1, WRMSR to the IA32_EFER MSR causes a general-protection exception if it would modify the LME bit. If VM entry has established CR0.PG = 1, the IA32_EFER MSR should not be included in the VM-entry MSR-load area for the purpose of modifying the LME bit.

control fields have been established.¹ The event is delivered using the vector in that field to select a descriptor in the IDT. Since event injection occurs after loading IDTR from the guest-state area, this is the guest IDT.

Section 27.6.1.1 provides details of vectored-event injection. In general, the event is delivered exactly as if it had been generated normally.

An exception is made if the following all hold: bit 25 (UINTR) is set to 1 in the guest CR4 field and the “IA-32e mode guest” VM-entry control is 1, and VM entry is modified if it is injecting an external interrupt whose vector is the value that UINV would have after VM entry. In this case, the logical processor then performs user-interrupt notification processing as specified in Section 7.5.2 instead of the process described in Section 27.6.1.1. (If the guest activity-state field indicated the HLT state, the logical processor enters the HLT state following user-interrupt notification processing.)

If event delivery (or user-interrupt notification processing; see above) encounters a nested exception (for example, a general-protection exception because the vector indicates a descriptor beyond the IDT limit), the exception bitmap is consulted using the vector of that exception:

- If the bit for the nested exception is 0, the nested exception is delivered normally. If the nested exception is benign, it is delivered through the IDT. If it is contributory or a page fault, a double fault may be generated, depending on the nature of the event whose delivery encountered the nested exception. See Chapter 6, “Interrupt 8—Double Fault Exception (#DF)” in the Intel® 64 and IA-32 Architectures Software Developer’s Manual, Volume 3A.²
- If the bit for the nested exception is 1, a VM exit occurs. Section 27.6.1.2 details cases in which event injection causes a VM exit.

27.6.1.1 Details of Vectored-Event Injection

The event-injection process is controlled by the contents of the VM-entry interruption information field (format given in Table 25-17), the VM-entry exception error-code field, and the VM-entry instruction-length field. The following items provide details of the process:

- The value pushed on the stack for RFLAGS is generally that which was loaded from the guest-state area. The value pushed for the RF flag is not modified based on the type of event being delivered. However, the pushed value of RFLAGS may be modified if a software interrupt is being injected into a guest that will be in virtual-8086 mode (see below). After RFLAGS is pushed on the stack, the value in the RFLAGS register is modified as is done normally when delivering an event through the IDT.
- The instruction pointer that is pushed on the stack depends on the type of event and whether nested exceptions occur during its delivery. The term **current guest RIP** refers to the value to be loaded from the guest-state area. The value pushed is determined as follows:³
 - If VM entry successfully injects (with no nested exception) an event with interruption type external interrupt, NMI, or hardware exception, the current guest RIP is pushed on the stack.
 - If VM entry successfully injects (with no nested exception) an event with interruption type software interrupt, privileged software exception, or software exception, the current guest RIP is incremented by the VM-entry instruction length before being pushed on the stack.
 - If VM entry encounters an exception while injecting an event and that exception does not cause a VM exit, the current guest RIP is pushed on the stack regardless of event type or VM-entry instruction length. If the encountered exception does cause a VM exit that saves RIP, the saved RIP is current guest RIP.
- If the deliver-error-code bit (bit 11) is set in the VM-entry interruption-information field, the contents of the VM-entry exception error-code field is pushed on the stack as an error code would be pushed during delivery of an exception.

1. This does not imply that injection of an exception or interrupt will cause a VM exit due to the settings of VM-execution control fields (such as the exception bitmap) that would cause a VM exit if the event had occurred in VMX non-root operation. In contrast, a nested exception encountered during event delivery may cause a VM exit; see Section 27.6.1.1.

2. Hardware exceptions with the following unused vectors are considered benign: 15 and 21–31. A hardware exception with vector 20 is considered benign unless the processor supports the 1-setting of the “EPT-violation #VE” VM-execution control; in that case, it has the same severity as page faults.

3. While these items refer to RIP, the width of the value pushed (16 bits, 32 bits, or 64 bits) is determined normally.

- DR6, DR7, and the IA32_DEBUGCTL MSR are not modified by event injection, even if the event has vector 1 (normal deliveries of debug exceptions, which have vector 1, do update these registers).
- If VM entry is injecting a software interrupt and the guest will be in virtual-8086 mode (RFLAGS.VM = 1), no general-protection exception can occur due to RFLAGS.IOPL < 3. A VM monitor should check RFLAGS.IOPL before injecting such an event and, if desired, inject a general-protection exception instead of a software interrupt.
- If VM entry is injecting a software interrupt and the guest will be in virtual-8086 mode with virtual-8086 mode extensions (RFLAGS.VM = CR4.VME = 1), event delivery is subject to VME-based interrupt redirection based on the software interrupt redirection bitmap in the task-state segment (TSS) as follows:
 - If bit n in the bitmap is clear (where n is the number of the software interrupt), the interrupt is directed to an 8086 program interrupt handler: the processor uses a 16-bit interrupt-vector table (IVT) located at linear address zero. If the value of RFLAGS.IOPL is less than 3, the following modifications are made to the value of RFLAGS that is pushed on the stack: IOPL is set to 3, and IF is set to the value of VIF.
 - If bit n in the bitmap is set (where n is the number of the software interrupt), the interrupt is directed to a protected-mode interrupt handler. (In other words, the injection is treated as described in the next item.) In this case, the software interrupt does not invoke such a handler if RFLAGS.IOPL < 3 (a general-protection exception occurs instead). However, as noted above, RFLAGS.IOPL cannot cause an injected software interrupt to cause such an exception. Thus, in this case, the injection invokes a protected-mode interrupt handler independent of the value of RFLAGS.IOPL.

Injection of events of other types are not subject to this redirection.

- If VM entry is injecting a software interrupt (not redirected as described above) or software exception, privilege checking is performed on the IDT descriptor being accessed as would be the case for executions of INT n , INT3, or INTO (the descriptor's DPL cannot be less than CPL). There is no checking of RFLAGS.IOPL, even if the guest will be in virtual-8086 mode. Failure of this check may lead to a nested exception. Injection of an event with interruption type external interrupt, NMI, hardware exception, and privileged software exception, or with interruption type software interrupt and being redirected as described above, do not perform these checks.
- If VM entry is injecting a non-maskable interrupt (NMI) and the "virtual NMIs" VM-execution control is 1, virtual-NMI blocking is in effect after VM entry.
- The transition causes a last-branch record to be logged if the LBR bit is set in the IA32_DEBUGCTL MSR. This is true even for events such as debug exceptions, which normally clear the LBR bit before delivery.
- The last-exception record MSRs (LERs) may be updated based on the setting of the LBR bit in the IA32_DEBUGCTL MSR. Events such as debug exceptions, which normally clear the LBR bit before they are delivered, and therefore do not normally update the LERs, may do so as part of VM-entry event injection.
- If injection of an event encounters a nested exception, the value of the EXT bit (bit 0) in any error code for that nested exception is determined as follows:
 - If event being injected has interruption type external interrupt, NMI, hardware exception, or privileged software exception and encounters a nested exception (but does not produce a double fault), the error code for that exception sets the EXT bit.
 - If event being injected is a software interrupt or a software exception and encounters a nested exception, the error code for that exception clears the EXT bit.
 - If event delivery encounters a nested exception and delivery of that exception encounters another exception (but does not produce a double fault), the error code for that exception sets the EXT bit.
 - If a double fault is produced, the error code for the double fault is 0000H (the EXT bit is clear).

27.6.1.2 VM Exits During Event Injection

An event being injected never causes a VM exit directly regardless of the settings of the VM-execution controls. For example, setting the "NMI exiting" VM-execution control to 1 does not cause a VM exit due to injection of an NMI.

However, the event-delivery process may lead to a VM exit:

- If the vector in the VM-entry interruption-information field identifies a task gate in the IDT, the attempted task switch may cause a VM exit just as it would had the injected event occurred during normal execution in VMX non-root operation (see Section 26.4.2).

- If event delivery encounters a nested exception, a VM exit may occur depending on the contents of the exception bitmap (see Section 26.2).
- If event delivery generates a double-fault exception (due to a nested exception); the logical processor encounters another nested exception while attempting to call the double-fault handler; and that exception does not cause a VM exit due to the exception bitmap; then a VM exit occurs due to triple fault (see Section 26.2).
- If event delivery injects a double-fault exception and encounters a nested exception that does not cause a VM exit due to the exception bitmap, then a VM exit occurs due to triple fault (see Section 26.2).
- If the “virtualize APIC accesses” VM-execution control is 1 and event delivery generates an access to the APIC-access page, that access is treated as described in Section 30.4 and may cause a VM exit.¹

If the event-delivery process does cause a VM exit, the processor state before the VM exit is determined just as it would be had the injected event occurred during normal execution in VMX non-root operation. If the injected event directly accesses a task gate that cause a VM exit or if the first nested exception encountered causes a VM exit, information about the injected event is saved in the IDT-vectoring information field (see Section 28.2.4).

The material in this section applies also if injection of an external interrupt results in user-interrupt notification processing instead of event delivery (see Section 27.6.1 earlier).

27.6.1.3 Event Injection for VM Entries to Real-Address Mode

If VM entry is loading CR0.PE with 0, any injected vectored event is delivered as would normally be done in real-address mode.² Specifically, VM entry uses the vector provided in the VM-entry interruption-information field to select a 4-byte entry from an interrupt-vector table at the linear address in IDTR.base. Further details are provided in Section 15.1.4 in the Intel® 64 and IA-32 Architectures Software Developer’s Manual, Volume 3A.

Because bit 11 (deliver error code) in the VM-entry interruption-information field must be 0 if CR0.PE will be 0 after VM entry (see Section 27.2.1.3), vectored events injected with CR0.PE = 0 do not push an error code on the stack. This is consistent with event delivery in real-address mode.

If event delivery encounters a fault (due to a violation of IDTR.limit or of SS.limit), the fault is treated as if it had occurred during event delivery in VMX non-root operation. Such a fault may lead to a VM exit as discussed in Section 27.6.1.2.

27.6.2 Injection of Pending MTF VM Exits

If the interruption type in the VM-entry interruption-information field is 7 (other event) and the vector field is 0, VM entry causes an MTF VM exit to be pending on the instruction boundary following VM entry. This is the case even if the “monitor trap flag” VM-execution control is 0. See Section 26.5.2 for the treatment of pending MTF VM exits.

27.7 SPECIAL FEATURES OF VM ENTRY

This section details a variety of features of VM entry. It uses the following terminology: a VM entry is **vectoring** if the valid bit (bit 31) of the VM-entry interruption information field is 1 and the interruption type in the field is 0 (external interrupt), 2 (non-maskable interrupt); 3 (hardware exception), 4 (software interrupt), 5 (privileged software exception), or 6 (software exception).

1. “Virtualize APIC accesses” is a secondary processor-based VM-execution control. If bit 31 of the primary processor-based VM-execution controls is 0, VM entry functions as if the “virtualize APIC accesses” VM-execution control were 0. See Section 25.6.2.

2. If the capability MSR IA32_VMX_CRO_FIXED0 reports that CR0.PE must be 1 in VMX operation, VM entry must be loading CR0.PE with 1 unless the “unrestricted guest” VM-execution control and bit 31 of the primary processor-based VM-execution controls are both 1.

27.7.1 Interruptibility State

The interruptibility-state field in the guest-state area (see Table 25-3) contains bits that control blocking by STI, blocking by MOV SS, and blocking by NMI. This field impacts event blocking after VM entry as follows:

- If the VM entry is vectoring, there is no blocking by STI or by MOV SS following the VM entry, regardless of the contents of the interruptibility-state field.
- If the VM entry is not vectoring, the following apply:
 - Events are blocked by STI if and only if bit 0 in the interruptibility-state field is 1. This blocking is cleared after the guest executes one instruction or incurs an exception (including a debug exception made pending by VM entry; see Section 27.7.3).
 - Events are blocked by MOV SS if and only if bit 1 in the interruptibility-state field is 1. This may affect the treatment of pending debug exceptions; see Section 27.7.3. This blocking is cleared after the guest executes one instruction or incurs an exception (including a debug exception made pending by VM entry).
- The blocking of non-maskable interrupts (NMIs) is determined as follows:
 - If the “virtual NMIs” VM-execution control is 0, NMIs are blocked if and only if bit 3 (blocking by NMI) in the interruptibility-state field is 1. If the “NMI exiting” VM-execution control is 0, execution of the IRET instruction removes this blocking (even if the instruction generates a fault). If the “NMI exiting” control is 1, IRET does not affect this blocking.
 - The following items describe the use of bit 3 (blocking by NMI) in the interruptibility-state field if the “virtual NMIs” VM-execution control is 1:
 - The bit’s value does not affect the blocking of NMIs after VM entry. NMIs are not blocked in VMX non-root operation (except for ordinary blocking for other reasons, such as by the MOV SS instruction, the wait-for-SIPI state, etc.)
 - The bit’s value determines whether there is virtual-NMI blocking after VM entry. If the bit is 1, virtual-NMI blocking is in effect after VM entry. If the bit is 0, there is no virtual-NMI blocking after VM entry unless the VM entry is injecting an NMI (see Section 27.6.1.1). Execution of IRET removes virtual-NMI blocking (even if the instruction generates a fault).

If the “NMI exiting” VM-execution control is 0, the “virtual NMIs” control must be 0; see Section 27.2.1.1.
- Blocking of system-management interrupts (SMIs) is determined as follows:
 - If the VM entry was not executed in system-management mode (SMM), SMI blocking is unchanged by VM entry.
 - If the VM entry was executed in SMM, SMIs are blocked after VM entry if and only if the bit 2 in the interruptibility-state field is 1.

27.7.2 Activity State

The activity-state field in the guest-state area controls whether, after VM entry, the logical processor is active or in one of the inactive states identified in Section 25.4.2. The use of this field is determined as follows:

- If the VM entry is vectoring, the logical processor is in the active state after VM entry. While the consistency checks described in Section 27.3.1.5 on the activity-state field do apply in this case, the contents of the activity-state field do not determine the activity state after VM entry.
- If the VM entry is not vectoring, the logical processor ends VM entry in the activity state specified in the guest-state area. If VM entry ends with the logical processor in an inactive activity state, the VM entry generates any special bus cycle that is normally generated when that activity state is entered from the active state. If VM entry would end with the logical processor in the shutdown state and the logical processor is in SMX operation,¹ an Intel® TXT shutdown condition occurs. The error code used is 0000H, indicating “legacy shutdown.” See the Intel® Trusted Execution Technology Preliminary Architecture Specification.

1. A logical processor is in SMX operation if GETSEC[SEXIT] has not been executed since the last execution of GETSEC[SENDER]. See Chapter 6, “Safer Mode Extensions Reference,” in the Intel® 64 and IA-32 Architectures Software Developer’s Manual, Volume 2B.

- Some activity states unconditionally block certain events. The following blocking is in effect after any VM entry that puts the processor in the indicated state:
 - The active state blocks start-up IPIs (SIPIs). SIPIs that arrive while a logical processor is in the active state and in VMX non-root operation are discarded and do not cause VM exits.
 - The HLT state blocks start-up IPIs (SIPIs). SIPIs that arrive while a logical processor is in the HLT state and in VMX non-root operation are discarded and do not cause VM exits.
 - The shutdown state blocks external interrupts and SIPIs. External interrupts that arrive while a logical processor is in the shutdown state and in VMX non-root operation do not cause VM exits even if the “external-interrupt exiting” VM-execution control is 1. SIPIs that arrive while a logical processor is in the shutdown state and in VMX non-root operation are discarded and do not cause VM exits.
 - The wait-for-SIPI state blocks external interrupts, non-maskable interrupts (NMIs), INIT signals, and system-management interrupts (SMIs). Such events do not cause VM exits if they arrive while a logical processor is in the wait-for-SIPI state and in VMX non-root operation.

27.7.3 Delivery of Pending Debug Exceptions after VM Entry

The pending debug exceptions field in the guest-state area indicates whether there are debug exceptions that have not yet been delivered (see Section 25.4.2). This section describes how these are treated on VM entry.

There are no pending debug exceptions after VM entry if any of the following are true:

- The VM entry is vectoring with one of the following interruption types: external interrupt, non-maskable interrupt (NMI), hardware exception, or privileged software exception.
- The interruptibility-state field does not indicate blocking by MOV SS and the VM entry is vectoring with either of the following interruption type: software interrupt or software exception.
- The VM entry is not vectoring and the activity-state field indicates either shutdown or wait-for-SIPI.

If none of the above hold, the pending debug exceptions field specifies the debug exceptions that are pending for the guest. There are **valid pending debug exceptions** if either the BS bit (bit 14) or the enable-breakpoint bit (bit 12) is 1. If there are valid pending debug exceptions, they are handled as follows:

- If the VM entry is not vectoring, the pending debug exceptions are treated as they would had they been encountered normally in guest execution:
 - If the logical processor is not blocking such exceptions (the interruptibility-state field indicates no blocking by MOV SS), a debug exception is delivered after VM entry (see below).
 - If the logical processor is blocking such exceptions (due to blocking by MOV SS), the pending debug exceptions are held pending or lost as would normally be the case.
- If the VM entry is vectoring (with interruption type software interrupt or software exception and with blocking by MOV SS), the following items apply:
 - For injection of a software interrupt or of a software exception with vector 3 (#BP) or vector 4 (#OF) — or a privileged software exception with vector 1 (#DB) — the pending debug exceptions are treated as they would had they been encountered normally in guest execution if the corresponding instruction (INT1, INT3, or INTO) were executed after a MOV SS that encountered a debug trap.
 - For injection of a software exception with a vector other than 3 and 4, the pending debug exceptions may be lost or they may be delivered after injection (see below).

If there are no valid pending debug exceptions (as defined above), no pending debug exceptions are delivered after VM entry.

If a pending debug exception is delivered after VM entry, it has the priority of “traps on the previous instruction” (see Section 6.9 in the Intel® 64 and IA-32 Architectures Software Developer’s Manual, Volume 3A). Thus, INIT signals and system-management interrupts (SMIs) take priority of such an exception, as do VM exits induced by the TPR threshold (see Section 27.7.7) and pending MTF VM exits (see Section 27.7.8). The exception takes priority over any pending non-maskable interrupt (NMI) or external interrupt and also over VM exits due to the 1-settings of the “interrupt-window exiting” and “NMI-window exiting” VM-execution controls.

A pending debug exception delivered after VM entry causes a VM exit if the bit 1 (#DB) is 1 in the exception bitmap. If it does not cause a VM exit, it updates DR6 normally.

27.7.4 VMX-Preemption Timer

If the “activate VMX-preemption timer” VM-execution control is 1, VM entry starts the VMX-preemption timer with the unsigned value in the VMX-preemption timer-value field.

It is possible for the VMX-preemption timer to expire during VM entry (e.g., if the value in the VMX-preemption timer-value field is zero). If this happens (and if the VM entry was not to the wait-for-SIPI state), a VM exit occurs with its normal priority after any event injection and before execution of any instruction following VM entry. For example, any pending debug exceptions established by VM entry (see Section 27.7.3) take priority over a timer-induced VM exit. (The timer-induced VM exit will occur after delivery of the debug exception, unless that exception or its delivery causes a different VM exit.)

See Section 26.5.1 for details of the operation of the VMX-preemption timer in VMX non-root operation, including the blocking and priority of the VM exits that it causes.

27.7.5 Interrupt-Window Exiting and Virtual-Interrupt Delivery

If “interrupt-window exiting” VM-execution control is 1, an open interrupt window may cause a VM exit immediately after VM entry (see Section 26.2 for details). If the “interrupt-window exiting” VM-execution control is 0 but the “virtual-interrupt delivery” VM-execution control is 1, a virtual interrupt may be delivered immediately after VM entry (see Section 27.3.2.5 and Section 30.2.1).

The following items detail the treatment of these events:

- These events occur after any event injection specified for VM entry.
- Non-maskable interrupts (NMIs) and higher priority events take priority over these events. These events take priority over external interrupts and lower priority events.
- These events wake the logical processor if it just entered the HLT state because of a VM entry (see Section 27.7.2). They do not occur if the logical processor just entered the shutdown state or the wait-for-SIPI state.

27.7.6 NMI-Window Exiting

The “NMI-window exiting” VM-execution control may cause a VM exit to occur immediately after VM entry (see Section 26.2 for details).

The following items detail the treatment of these VM exits:

- These VM exits follow event injection if such injection is specified for VM entry.
- Debug-trap exceptions (see Section 27.7.3) and higher priority events take priority over VM exits caused by this control. VM exits caused by this control take priority over non-maskable interrupts (NMIs) and lower priority events.
- VM exits caused by this control wake the logical processor if it just entered either the HLT state or the shutdown state because of a VM entry (see Section 27.7.2). They do not occur if the logical processor just entered the wait-for-SIPI state.

27.7.7 VM Exits Induced by the TPR Threshold

If the “use TPR shadow” and “virtualize APIC accesses” VM-execution controls are both 1 and the “virtual-interrupt delivery” VM-execution control is 0, a VM exit occurs immediately after VM entry if the value of bits 3:0 of the TPR threshold VM-execution control field is greater than the value of bits 7:4 of VTPR (see Section 30.1.1).¹

1. “Virtualize APIC accesses” and “virtual-interrupt delivery” are secondary processor-based VM-execution controls. If bit 31 of the primary processor-based VM-execution controls is 0, VM entry functions as if these controls were 0. See Section 25.6.2.

The following items detail the treatment of these VM exits:

- The VM exits are not blocked if RFLAGS.IF = 0 or by the setting of bits in the interruptibility-state field in guest-state area.
- The VM exits follow event injection if such injection is specified for VM entry.
- VM exits caused by this control take priority over system-management interrupts (SMIs), INIT signals, and lower priority events. They thus have priority over the VM exits described in Section 27.7.5, Section 27.7.6, and Section 27.7.8, as well as any interrupts or debug exceptions that may be pending at the time of VM entry.
- These VM exits wake the logical processor if it just entered the HLT state as part of a VM entry (see Section 27.7.2). They do not occur if the logical processor just entered the shutdown state or the wait-for-SIPI state. If such a VM exit is suppressed because the processor just entered the shutdown state, it occurs after the delivery of any event that cause the logical processor to leave the shutdown state while remaining in VMX non-root operation (e.g., due to an NMI that occurs while the “NMI-exiting” VM-execution control is 0).
- The basic exit reason is “TPR below threshold.”

27.7.8 Pending MTF VM Exits

As noted in Section 27.6.2, VM entry may cause an MTF VM exit to be pending immediately after VM entry. The following items detail the treatment of these VM exits:

- System-management interrupts (SMIs), INIT signals, and higher priority events take priority over these VM exits. These VM exits take priority over debug-trap exceptions and lower priority events.
- These VM exits wake the logical processor if it just entered the HLT state because of a VM entry (see Section 27.7.2). They do not occur if the logical processor just entered the shutdown state or the wait-for-SIPI state.

27.7.9 VM Entries and Advanced Debugging Features

VM entries are not logged with last-branch records, do not produce branch-trace messages, and do not update the branch-trace store.

27.7.10 User-Interrupt Recognition After VM Entry

A VM entry results in recognition of a pending user interrupt if it completes with CR4.UINTR = IA32_EFER.LMA = 1 and with UIRR ≠ 0; otherwise, no pending user interrupt is recognized.

27.8 VM-ENTRY FAILURES DURING OR AFTER LOADING GUEST STATE

VM-entry failures due to the checks identified in Section 27.3.1 and failures during the MSR loading identified in Section 27.4 are treated differently from those that occur earlier in VM entry. In these cases, the following steps take place:

1. Information about the VM-entry failure is recorded in the VM-exit information fields:
 - Exit reason.
 - Bits 15:0 of this field contain the basic exit reason. It is loaded with a number indicating the general cause of the VM-entry failure. The following numbers are used:
 33. VM-entry failure due to invalid guest state. A VM entry failed one of the checks identified in Section 27.3.1.
 34. VM-entry failure due to MSR loading. A VM entry failed in an attempt to load MSRs (see Section 27.4).
 41. VM-entry failure due to machine-check event. A machine-check event occurred during VM entry (see Section 27.9).

- Bit 31 is set to 1 to indicate a VM-entry failure.
 - The remainder of the field (bits 30:16) is cleared.
- Exit qualification. This field is set based on the exit reason.
- VM-entry failure due to invalid guest state. In most cases, the exit qualification is cleared to 0. The following non-zero values are used in the cases indicated:
 1. Not used.
 2. Failure was due to a problem loading the PDPTes (see Section 27.3.1.6).
 3. Failure was due to an attempt to inject a non-maskable interrupt (NMI) into a guest that is blocking events through the STI blocking bit in the interruptibility-state field.
 4. Failure was due to an invalid VMCS link pointer (see Section 27.3.1.5).

VM-entry checks on guest-state fields may be performed in any order. Thus, an indication by exit qualification of one cause does not imply that there are not also other errors. Different processors may give different exit qualifications for the same VMCS.
 - VM-entry failure due to MSR loading. The exit qualification is loaded to indicate which entry in the VM-entry MSR-load area caused the problem (1 for the first entry, 2 for the second, etc.).
- All other VM-exit information fields are unmodified.
2. Processor state is loaded as would be done on a VM exit (see Section 28.5). If this results in $[CR4.PAE \& CR0.PG \& \sim IA32_EFER.LMA] = 1$, page-directory-pointer-table entries (PDPTes) may be checked and loaded (see Section 28.5.4).
 3. The state of blocking by NMI is what it was before VM entry.
 4. MSRs are loaded as specified in the VM-exit MSR-load area (see Section 28.6).

Although this process resembles that of a VM exit, many steps taken during a VM exit do not occur for these VM-entry failures:

- Most VM-exit information fields are not updated (see step 1 above).
- The valid bit in the VM-entry interruption-information field is not cleared.
- The guest-state area is not modified.
- No MSRs are saved into the VM-exit MSR-store area.

27.9 MACHINE-CHECK EVENTS DURING VM ENTRY

If a machine-check event occurs during a VM entry, one of the following occurs:

- The machine-check event is handled as if it occurred before the VM entry:
 - If $CR4.MCE = 0$, operation of the logical processor depends on whether the logical processor is in SMX operation:¹
 - If the logical processor is in SMX operation, an Intel[®] TXT shutdown condition occurs. The error code used is 000CH, indicating “unrecoverable machine-check condition.”
 - If the logical processor is outside SMX operation, it goes to the shutdown state.
 - If $CR4.MCE = 1$, a machine-check exception (#MC) is delivered through the IDT.
- The machine-check event is handled after VM entry completes:
 - If the VM entry ends with $CR4.MCE = 0$, operation of the logical processor depends on whether the logical processor is in SMX operation:

1. A logical processor is in SMX operation if GETSEC[SEXIT] has not been executed since the last execution of GETSEC[SENDER]. A logical processor is outside SMX operation if GETSEC[SENDER] has not been executed or if GETSEC[SEXIT] was executed after the last execution of GETSEC[SENDER]. See Chapter 7, “Safer Mode Extensions Reference,” in the Intel[®] 64 and IA-32 Architectures Software Developer’s Manual, Volume 2D.

VM ENTRIES

- If the logical processor is in SMX operation, an Intel[®] TXT shutdown condition occurs with error code 000CH (unrecoverable machine-check condition).
- If the logical processor is outside SMX operation, it goes to the shutdown state.
- If the VM entry ends with CR4.MCE = 1, a machine-check exception (#MC) is generated:
 - If bit 18 (#MC) of the exception bitmap is 0, the exception is delivered through the guest IDT.
 - If bit 18 of the exception bitmap is 1, the exception causes a VM exit.
- A VM-entry failure occurs as described in Section 27.8. The basic exit reason is 41, for “VM-entry failure due to machine-check event.”

The first option is not used if the machine-check event occurs after any guest state has been loaded. The second option is used only if VM entry is able to load all guest state.

VM exits occur in response to certain instructions and events in VMX non-root operation as detailed in Section 26.1 through Section 26.2. VM exits perform the following operations:

1. Information about the cause of the VM exit is recorded in the VM-exit information fields and VM-entry control fields are modified as described in Section 28.2.
2. Processor state is saved in the guest-state area (Section 28.3).
3. MSRs may be saved in the VM-exit MSR-store area (Section 28.4). This step is not performed for SMM VM exits that activate the dual-monitor treatment of SMIs and SMM.
4. The following may be performed in parallel and in any order (Section 28.5):
 - Processor state is loaded based in part on the host-state area and some VM-exit controls. This step is not performed for SMM VM exits that activate the dual-monitor treatment of SMIs and SMM. See Section 32.15.6 for information on how processor state is loaded by such VM exits.
 - Address-range monitoring is cleared.
5. MSRs may be loaded from the VM-exit MSR-load area (Section 28.6). This step is not performed for SMM VM exits that activate the dual-monitor treatment of SMIs and SMM.

VM exits are not logged with last-branch records, do not produce branch-trace messages, and do not update the branch-trace store.

Section 28.1 clarifies the nature of the architectural state before a VM exit begins. The steps described above are detailed in Section 28.2 through Section 28.6.

Section 32.15 describes the dual-monitor treatment of system-management interrupts (SMIs) and system-management mode (SMM). Under this treatment, ordinary transitions to SMM are replaced by VM exits to a separate SMM monitor. Called **SMM VM exits**, these are caused by the arrival of an SMI or the execution of VMCALL in VMX root operation. SMM VM exits differ from other VM exits in ways that are detailed in Section 32.15.2.

28.1 ARCHITECTURAL STATE BEFORE A VM EXIT

This section describes the architectural state that exists before a VM exit, especially for VM exits caused by events that would normally be delivered through the IDT. Note the following:

- An exception causes a VM exit **directly** if the bit corresponding to that exception is set in the exception bitmap. A non-maskable interrupt (NMI) causes a VM exit directly if the “NMI exiting” VM-execution control is 1. An external interrupt causes a VM exit directly if the “external-interrupt exiting” VM-execution control is 1. A start-up IPI (SIPI) that arrives while a logical processor is in the wait-for-SIPI activity state causes a VM exit directly. INIT signals that arrive while the processor is not in the wait-for-SIPI activity state cause VM exits directly.
- An exception, NMI, external interrupt, or software interrupt causes a VM exit **indirectly** if it does not do so directly but delivery of the event causes a nested exception, double fault, task switch, APIC access (see Section 30.4), EPT violation, EPT misconfiguration, page-modification log-full event (see Section 29.3.6), or SPP-related event (see Section 29.3.4) that causes a VM exit.
- An event **results** in a VM exit if it causes a VM exit (directly or indirectly).

The following bullets detail when architectural state is and is not updated in response to VM exits:

- If an event causes a VM exit directly, it does not update architectural state as it would have if it had it not caused the VM exit:
 - A debug exception does not update DR6, DR7, or IA32_DEBUGCTL. (Information about the nature of the debug exception is saved in the exit qualification field.)
 - A page fault does not update CR2. (The linear address causing the page fault is saved in the exit-qualification field.)

- An NMI causes subsequent NMIs to be blocked, but only after the VM exit completes.
 - An external interrupt does not acknowledge the interrupt controller and the interrupt remains pending, unless the “acknowledge interrupt on exit” VM-exit control is 1. In such a case, the interrupt controller is acknowledged and the interrupt is no longer pending.
 - The flags L0 – L3 in DR7 (bit 0, bit 2, bit 4, and bit 6) are not cleared when a task switch causes a VM exit.
 - If a task switch causes a VM exit, none of the following are modified by the task switch: old task-state segment (TSS); new TSS; old TSS descriptor; new TSS descriptor; RFLAGS.NT¹; or the TR register.
 - No last-exception record is made if the event that would do so directly causes a VM exit.
 - If a machine-check exception causes a VM exit directly, this does not prevent machine-check MSRs from being updated. These are updated by the machine-check event itself and not the resulting machine-check exception.
 - If the logical processor is in an inactive state (see Section 25.4.2) and not executing instructions, some events may be blocked but others may return the logical processor to the active state. Unblocked events may cause VM exits.² If an unblocked event causes a VM exit directly, a return to the active state occurs only after the VM exit completes.³ The VM exit generates any special bus cycle that is normally generated when the active state is entered from that activity state.
- MTF VM exits (see Section 26.5.2 and Section 27.7.8) are not blocked in the HLT activity state. If an MTF VM exit occurs in the HLT activity state, the logical processor returns to the active state only after the VM exit completes. MTF VM exits are blocked the shutdown state and the wait-for-SIPI state.
- If an event causes a VM exit indirectly, the event does update architectural state:
 - A debug exception updates DR6, DR7, and the IA32_DEBUGCTL MSR. No debug exceptions are considered pending.
 - A page fault updates CR2.
 - An NMI causes subsequent NMIs to be blocked before the VM exit commences.
 - An external interrupt acknowledges the interrupt controller and the interrupt is no longer pending.
 - If the logical processor had been in an inactive state, it enters the active state and, before the VM exit commences, generates any special bus cycle that is normally generated when the active state is entered from that activity state.
 - There is no blocking by STI or by MOV SS when the VM exit commences.
 - Processor state that is normally updated as part of delivery through the IDT (CS, RIP, SS, RSP, RFLAGS) is not modified. However, the incomplete delivery of the event may write to the stack.
 - The treatment of last-exception records is implementation dependent:
 - Some processors make a last-exception record when beginning the delivery of an event through the IDT (before it can encounter a nested exception). Such processors perform this update even if the event encounters a nested exception that causes a VM exit (including the case where nested exceptions lead to a triple fault).
 - Other processors delay making a last-exception record until event delivery has reached some event handler successfully (perhaps after one or more nested exceptions). Such processors do not update the last-exception record if a VM exit or triple fault occurs before an event handler is reached.

1. This chapter uses the notation RAX, RIP, RSP, RFLAGS, etc. for processor registers because most processors that support VMX operation also support Intel 64 architecture. For processors that do not support Intel 64 architecture, this notation refers to the 32-bit forms of those registers (EAX, EIP, ESP, EFLAGS, etc.). In a few places, notation such as EAX is used to refer specifically to lower 32 bits of the indicated register.

2. If a VM exit takes the processor from an inactive state resulting from execution of a specific instruction (HLT or MWAIT), the value saved for RIP by that VM exit will reference the following instruction.

3. An exception is made if the logical processor had been inactive due to execution of MWAIT; in this case, it is considered to have become active before the VM exit.

- If the “virtual NMIs” VM-execution control is 1, VM entry injects an NMI, and delivery of the NMI causes a nested exception, double fault, task switch, EPT violation, EPT misconfiguration, page-modification log-full event, or SPP-related event, or APIC access that causes a VM exit, virtual-NMI blocking is in effect before the VM exit commences.
- If a VM exit results from a fault, EPT violation, EPT misconfiguration, page-modification log-full event, or SPP-related event that is encountered during execution of IRET and the “NMI exiting” VM-execution control is 0, any blocking by NMI is cleared before the VM exit commences. However, the previous state of blocking by NMI may be recorded in the exit qualification or in the VM-exit interruption-information field; see Section 28.2.3.
- If a VM exit results from a fault, EPT violation, EPT misconfiguration, page-modification log-full event, or SPP-related event that is encountered during execution of IRET and the “virtual NMIs” VM-execution control is 1, virtual-NMI blocking is cleared before the VM exit commences. However, the previous state of blocking by NMI may be recorded in the exit qualification or in the VM-exit interruption-information field; see Section 28.2.3.
- Suppose that a VM exit is caused directly by an x87 FPU Floating-Point Error (#MF) or by any of the following events if the event was unblocked due to (and given priority over) an x87 FPU Floating-Point Error: an INIT signal, an external interrupt, an NMI, an SMI; or a machine-check exception. In these cases, there is no blocking by STI or by MOV SS when the VM exit commences.
- Normally, a last-branch record may be made when an event is delivered through the IDT. However, if such an event results in a VM exit before delivery is complete, no last-branch record is made.
- If machine-check exception results in a VM exit, processor state is suspect and may result in suspect state being saved to the guest-state area. A VM monitor should consult the RIPV and EIPV bits in the IA32_MCG_STATUS MSR before resuming a guest that caused a VM exit resulting from a machine-check exception.
- If a VM exit results from a fault, APIC access (see Section 30.4), EPT violation, EPT misconfiguration, page-modification log-full event, or SPP-related event that is encountered while executing an instruction, data breakpoints due to that instruction may have been recognized and information about them may be saved in the pending debug exceptions field (unless the VM exit clears that field; see Section 28.3.4).
- The following VM exits are considered to happen after an instruction is executed:
 - VM exits resulting from debug traps (single-step, I/O breakpoints, and data breakpoints).
 - VM exits resulting from debug exceptions (data breakpoints) whose recognition was delayed by blocking by MOV SS.
 - VM exits resulting from some machine-check exceptions.
 - Trap-like VM exits due to execution of MOV to CR8 when the “CR8-load exiting” VM-execution control is 0 and the “use TPR shadow” VM-execution control is 1 (see Section 30.3). (Such VM exits can occur only from 64-bit mode and thus only on processors that support Intel 64 architecture.)
 - Trap-like VM exits due to execution of WRMSR when the “use MSR bitmaps” VM-execution control is 1; the value of ECX is in the range 800H–8FFH; and the bit corresponding to the ECX value in write bitmap for low MSRs is 0; and the “virtualize x2APIC mode” VM-execution control is 1. See Section 30.5.
 - VM exits caused by APIC-write emulation (see Section 30.4.3.2) that result from APIC accesses as part of instruction execution.

For these VM exits, the instruction’s modifications to architectural state complete before the VM exit occurs. Such modifications include those to the logical processor’s interruptibility state (see Table 25-3). If there had been blocking by MOV SS, POP SS, or STI before the instruction executed, such blocking is no longer in effect.

A VM exit that occurs in enclave mode sets bit 27 of the exit-reason field and bit 4 of the guest interruptibility-state field. Before such a VM exit is delivered, an Asynchronous Enclave Exit (AEX) occurs (see Chapter 37, “Enclave Exiting Events”). An AEX modifies architectural state (Section 37.3). In particular, the processor establishes the following architectural state as indicated:

- The following bits in RFLAGS are cleared: CF, PF, AF, ZF, SF, OF, and RF.
- FS and GS are restored to the values they had prior to the most recent enclave entry.
- RIP is loaded with the AEP of interrupted enclave thread.
- RSP is loaded from the URSP field in the enclave’s state-save area (SSA).

28.2 RECORDING VM-EXIT INFORMATION AND UPDATING VM-ENTRY CONTROL FIELDS

VM exits begin by recording information about the nature of and reason for the VM exit in the VM-exit information fields. Section 28.2.1 to Section 28.2.5 detail the use of these fields.

In addition to updating the VM-exit information fields, the valid bit (bit 31) is cleared in the VM-entry interruption-information field. If bit 5 of the IA32_VMX_MISC MSR (index 485H) is read as 1 (see Appendix A.6), the value of IA32_EFER.LMA is stored into the “IA-32e mode guest” VM-entry control.¹

28.2.1 Basic VM-Exit Information

Section 25.9.1 defines the basic VM-exit information fields. The following items detail their use.

- **Exit reason.**
 - Bits 15:0 of this field contain the basic exit reason. It is loaded with a number indicating the general cause of the VM exit. Appendix C lists the numbers used and their meaning.
 - Bit 25 is set if the “prematurely busy shadow stack” VM-exit control is 1 and the VM exit caused a shadow stack become prematurely busy (see Section 26.4.3). Otherwise, the bit is cleared.
 - Bit 26 of this field is set to 1 if the VM exit occurred after assertion of a bus lock while the “VMM bus-lock detection” VM-execution control was 1. Such VM exits include those that occur due to the 1-setting of that control as well as others that might occur during execution of an instruction that asserted a bus lock.
 - Bit 27 of this field is set to 1 if the VM exit occurred while the logical processor was in enclave mode. Such VM exits include those caused by interrupts, non-maskable interrupts, system-management interrupts, INIT signals, and exceptions occurring in enclave mode as well as exceptions encountered during the delivery of such events incident to enclave mode. A VM exit also sets this bit if it is incident to delivery of an event injected by VM entry and the guest interruptibility-state field indicates an enclave interruption (bit 4 of the field is 1).
 - The remainder of the field (bits 31:28 and bits 24:16) is cleared to 0 (certain SMM VM exits may set some of these bits; see Section 32.15.2.3).²
- **Exit qualification.** This field is saved for VM exits due to the following causes: debug exceptions; page-fault exceptions; start-up IPIs (SIPIs); system-management interrupts (SMIs) that arrive immediately after the execution of I/O instructions; task switches; INVEPT; INVLPG; INVPCID; INVVPID; LGDT; LIDT; LLDT; LTR; SGDT; SIDT; SLDT; STR; VMCLEAR; VMPTRLD; VMPTRST; VMREAD; VMWRITE; VMXON; WBINVD; WBNOINVD; XRSTORS; XSAVES; control-register accesses; MOV DR; I/O instructions; MWAIT; accesses to the APIC-access page (see Section 30.4); EPT violations (see Section 29.3.3.2); EOI virtualization (see Section 30.1.4); APIC-write emulation (see Section 30.4.3.3); page-modification log full (see Section 29.3.6); SPP-related events (see Section 29.3.4); and instruction timeout (see Section 26.2). For all other VM exits, this field is cleared. The following items provide details:
 - For a debug exception, the exit qualification contains information about the debug exception. The information has the format given in Table 28-1.

Table 28-1. Exit Qualification for Debug Exceptions

Bit Position(s)	Contents
3:0	B3 - B0. When set, each of these bits indicates that the corresponding breakpoint condition was met. Any of these bits may be set even if its corresponding enabling bit in DR7 is not set.
10:4	Not currently defined.

1. Bit 5 of the IA32_VMX_MISC MSR is read as 1 on any logical processor that supports the 1-setting of the “unrestricted guest” VM-execution control.
 2. Bit 31 of this field is set on certain VM-entry failures; see Section 27.8.

Table 28-1. Exit Qualification for Debug Exceptions (Contd.)

Bit Position(s)	Contents
11	BLD. When set, this bit indicates that a bus lock was asserted while OS bus-lock detection was enabled and CPL > 0 (see Section 18.3.1.6 (“OS Bus-Lock Detection”)). ¹
12	Not currently defined.
13	BD. When set, this bit indicates that the cause of the debug exception is “debug register access detected.”
14	BS. When set, this bit indicates that the cause of the debug exception is either the execution of a single instruction (if RFLAGS.TF = 1 and IA32_DEBUGCTL.BTF = 0) or a taken branch (if RFLAGS.TF = DEBUGCTL.BTF = 1).
15	Not currently defined.
16	RTM. When set, this bit indicates that a debug exception (#DB) or a breakpoint exception (#BP) occurred inside an RTM region while advanced debugging of RTM transactional regions was enabled (see Section 16.3.7, “RTM-Enabled Debugger Support,” of the Intel® 64 and IA-32 Architectures Software Developer’s Manual, Volume 1). ²
63:17	Not currently defined. Bits 63:32 exist only on processors that support Intel 64 architecture.

NOTES:

1. In general, the format of this field matches that of DR6. However, DR6 **clears** bit 11 to indicate detection of a bus lock, while this field **sets** the bit to indicate that condition.
2. In general, the format of this field matches that of DR6. However, DR6 **clears** bit 16 to indicate an RTM-related exception, while this field **sets** the bit to indicate that condition.

- For a page-fault exception, the exit qualification contains the linear address that caused the page fault. On processors that support Intel 64 architecture, bits 63:32 are cleared if the logical processor was not in 64-bit mode before the VM exit.

If the page-fault exception occurred during execution of an instruction in enclave mode (and not during delivery of an event incident to enclave mode), bits 11:0 of the exit qualification are cleared.

- For a start-up IPI (SIPI), the exit qualification contains the SIPI vector information in bits 7:0. Bits 63:8 of the exit qualification are cleared to 0.
- For a task switch, the exit qualification contains details about the task switch, encoded as shown in Table 28-2.
- For INVLPG, the exit qualification contains the linear-address operand of the instruction.
 - On processors that support Intel 64 architecture, bits 63:32 are cleared if the logical processor was not in 64-bit mode before the VM exit.
 - If the INVLPG source operand specifies an unusable segment, the linear address specified in the exit qualification will match the linear address that the INVLPG would have used if no VM exit occurred. This address is not architecturally defined and may be implementation-specific.

Table 28-2. Exit Qualification for Task Switches

Bit Position(s)	Contents
15:0	Selector of task-state segment (TSS) to which the guest attempted to switch
29:16	Not currently defined

Table 28-2. Exit Qualification for Task Switches (Contd.)

Bit Position(s)	Contents
31:30	Source of task switch initiation: 0: CALL instruction 1: IRET instruction 2: JMP instruction 3: Task gate in IDT
63:32	Not currently defined. These bits exist only on processors that support Intel 64 architecture.

- For INVEPT, INVPCID, INVVPID, LGDT, LIDT, LLDT, LTR, SGDT, SIDT, SLDT, STR, VMCLEAR, VMPTRLD, VMPTRST, VMREAD, VMWRITE, VMXON, XRSTORS, and XSAVES, the exit qualification receives the value of the instruction’s displacement field, which is sign-extended to 64 bits if necessary (32 bits on processors that do not support Intel 64 architecture). If the instruction has no displacement (for example, has a register operand), zero is stored into the exit qualification.

On processors that support Intel 64 architecture, an exception is made for RIP-relative addressing (used only in 64-bit mode). Such addressing causes an instruction to use an address that is the sum of the displacement field and the value of RIP that references the following instruction. In this case, the exit qualification is loaded with the sum of the displacement field and the appropriate RIP value.

In all cases, bits of this field beyond the instruction’s address size are undefined. For example, suppose that the address-size field in the VM-exit instruction-information field (see Section 25.9.4 and Section 28.2.5) reports an *n*-bit address size. Then bits 63:*n* (bits 31:*n* on processors that do not support Intel 64 architecture) of the instruction displacement are undefined.

- For a control-register access, the exit qualification contains information about the access and has the format given in Table 28-3.
- For MOV DR, the exit qualification contains information about the instruction and has the format given in Table 28-4.
- For an I/O instruction, the exit qualification contains information about the instruction and has the format given in Table 28-5.
- For MWAIT, the exit qualification contains a value that indicates whether address-range monitoring hardware was armed. The exit qualification is set either to 0 (if address-range monitoring hardware is not armed) or to 1 (if address-range monitoring hardware is armed).
- WBINVD and WBNOINVD use the same basic exit reason (see Appendix C). For WBINVD, the exit qualification is 0, while for WBNOINVD it is 1.
- For an APIC-access VM exit resulting from a linear access or a guest-physical access to the APIC-access page (see Section 30.4), the exit qualification contains information about the access and has the format given in Table 28-6.¹

If the access to the APIC-access page occurred during execution of an instruction in enclave mode (and not during delivery of an event incident to enclave mode), bits 11:0 of the exit qualification are cleared.

Such a VM exit that set bits 15:12 of the exit qualification to 0000b (data read during instruction execution) or 0001b (data write during instruction execution) set bit 12—which distinguishes data read from data write—to that which would have been stored in bit 1—W/R—of the page-fault error code had the access caused a page fault instead of an APIC-access VM exit. This implies the following:

- For an APIC-access VM exit caused by the CLFLUSH and CLFLUSHOPT instructions, the access type is “data read during instruction execution.”
- For an APIC-access VM exit caused by the ENTER instruction, the access type is “data write during instruction execution.”

1. The exit qualification is undefined if the access was part of the logging of a branch record or a processor-event-based-sampling (PEBS) record to the DS save area. It is recommended that software configure the paging structures so that no address in the DS save area translates to an address on the APIC-access page.

Table 28-3. Exit Qualification for Control-Register Accesses

Bit Positions	Contents
3:0	Number of control register (0 for CLTS and LMSW). Bit 3 is always 0 on processors that do not support Intel 64 architecture as they do not support CR8.
5:4	Access type: 0 = MOV to CR 1 = MOV from CR 2 = CLTS 3 = LMSW
6	LMSW operand type: 0 = register 1 = memory For CLTS and MOV CR, cleared to 0
7	Not currently defined
11:8	For MOV CR, the general-purpose register: 0 = RAX 1 = RCX 2 = RDX 3 = RBX 4 = RSP 5 = RBP 6 = RSI 7 = RDI 8-15 represent R8-R15, respectively (used only on processors that support Intel 64 architecture) For CLTS and LMSW, cleared to 0
15:12	Not currently defined
31:16	For LMSW, the LMSW source data For CLTS and MOV CR, cleared to 0
63:32	Not currently defined. These bits exist only on processors that support Intel 64 architecture.

- For an APIC-access VM exit caused by the MASKMOVQ instruction or the MASKMOVDQU instruction, the access type is “data write during instruction execution.”
- For an APIC-access VM exit caused by the MONITOR instruction, the access type is “data read during instruction execution.”
- For an APIC-access VM exit caused directly by an access to a linear address in the DS save area (BTS or PEBS), the access type is “linear access for monitoring.”
- For an APIC-access VM exit caused by a guest-physical access performed for an access to the DS save area (e.g., to access a paging structure to translate a linear address), the access type is “guest-physical access for monitoring or trace.”
- For an APIC-access VM exit caused by trace-address pre-translation (TAPT) when the “Intel PT uses guest physical addresses” VM-execution control is 1, the access type is “guest-physical access for monitoring or trace.”

Such a VM exit stores 1 for bit 31 for IDT-vectoring information field (see Section 28.2.4) if and only if it sets bits 15:12 of the exit qualification to 0011b (linear access during event delivery) or 1010b (guest-physical access during event delivery).

See Section 30.4.4 for further discussion of these instructions and APIC-access VM exits.

For APIC-access VM exits resulting from physical accesses to the APIC-access page (see Section 30.4.6), the exit qualification is undefined.

- For an EPT violation, the exit qualification contains information about the access causing the EPT violation and has the format given in Table 28-7.

As noted in that table, the format and meaning of the exit qualification depends on the setting of the “mode-based execute control for EPT” VM-execution control and whether the processor supports advanced VM-exit information for EPT violations.¹

An EPT violation that occurs during as a result of execution of a read-modify-write operation sets bit 1 (data write). Whether it also sets bit 0 (data read) is implementation-specific and, for a given implementation, may differ for different kinds of read-modify-write operations.

Table 28-4. Exit Qualification for MOV DR

Bit Position(s)	Contents
2:0	Number of debug register
3	Not currently defined
4	Direction of access (0 = MOV to DR; 1 = MOV from DR)
7:5	Not currently defined
11:8	General-purpose register: 0 = RAX 1 = RCX 2 = RDX 3 = RBX 4 = RSP 5 = RBP 6 = RSI 7 = RDI 8 - 15 = R8 - R15, respectively
63:12	Not currently defined. Bits 63:32 exist only on processors that support Intel 64 architecture.

Table 28-5. Exit Qualification for I/O Instructions

Bit Position(s)	Contents
2:0	Size of access: 0 = 1-byte 1 = 2-byte 3 = 4-byte Other values not used
3	Direction of the attempted access (0 = OUT, 1 = IN)
4	String instruction (0 = not string; 1 = string)

1. Software can determine whether advanced VM-exit information for EPT violations is supported by consulting the VMX capability MSR IA32_VMX_EPT_VPID_CAP (see Appendix A.10).

Table 28-5. Exit Qualification for I/O Instructions (Contd.)

Bit Position(s)	Contents
5	REP prefixed (0 = not REP; 1 = REP)
6	Operand encoding (0 = DX, 1 = immediate)
15:7	Not currently defined
31:16	Port number (as specified in DX or in an immediate operand)
63:32	Not currently defined. These bits exist only on processors that support Intel 64 architecture.

Table 28-6. Exit Qualification for APIC-Access VM Exits from Linear Accesses and Guest-Physical Accesses

Bit Position(s)	Contents
11:0	<ul style="list-style-type: none"> ▪ If the APIC-access VM exit is due to a linear access, the offset of access within the APIC page. ▪ Undefined if the APIC-access VM exit is due a guest-physical access
15:12	<p>Access type:</p> <ul style="list-style-type: none"> 0 = linear access for a data read during instruction execution 1 = linear access for a data write during instruction execution 2 = linear access for an instruction fetch 3 = linear access (read or write) during event delivery 4 = linear access for monitoring 10 = guest-physical access during event delivery 11 = guest-physical access for monitoring or trace 15 = guest-physical access for an instruction fetch or during instruction execution <p>Other values not used</p>
16	This bit is set for certain accesses that are asynchronous to instruction execution and not part of event delivery. These includes guest-physical accesses related to trace output by Intel PT (see Section 26.5.4), accesses related to PEBS on processors with the “EPT-friendly” enhancement (see Section 20.9.5), and accesses that occur during user-interrupt delivery (see Section 7.4.2).
63:17	Not currently defined. Bits 63:32 exist only on processors that support Intel 64 architecture.

Bit 12 reports “NMI unblocking due to IRET”; see Section 28.2.3.

Bit 16 is set for certain accesses that are asynchronous to instruction execution and not part of event delivery. These include trace-address pre-translation (TAPT) for Intel PT (see Section 26.5.4), accesses related to PEBS on processors with the “EPT-friendly” enhancement (see Section 20.9.5), and accesses as part of user-interrupt delivery (see Section 7.4.2).

- For VM exits caused as part of EOI virtualization (Section 30.1.4), bits 7:0 of the exit qualification are set to vector of the virtual interrupt that was dismissed by the EOI virtualization. Bits above bit 7 are cleared.
- For APIC-write VM exits (Section 30.4.3.3), bits 11:0 of the exit qualification are set to the page offset of the write access that caused the VM exit.¹ Bits above bit 11 are cleared.
- For a VM exit due to a page-modification log-full event (Section 29.3.6), bit 12 of the exit qualification reports “NMI unblocking due to IRET” (see Section 28.2.3). Bit 16 is set if the VM exit occurs during TAPT, EPT-friendly PEBS, or user-interrupt delivery. All other bits of the exit qualification are undefined.
- For a VM exit due to an SPP-related event (Section 29.3.4), bit 11 of the exit qualification indicates the type of event: 0 indicates an SPP misconfiguration and 1 indicates an SPP miss. Bit 12 of the exit qualification

1. Execution of WRMSR with ECX = 83FH (self-IPI MSR) can lead to an APIC-write VM exit; the exit qualification for such an APIC-write VM exit is 3F0H.

reports “NMI unblocking due to IRET” (see Section 28.2.3). Bit 16 is set if the VM exit occurs during TAPT EPT-friendly PEBS, or user-interrupt delivery. All other bits of the exit qualification are undefined.

- If the “PASID translation” VM-execution control, PASID translation is performed for executions of the ENQCMD and ENQCMDs instructions (see Section 26.5.8). PASID translation may fail, resulting in a VM exit. Such a VM exit saves an exit qualification specified in the following items:
 - For ENQCMD, the exit qualification is IA32_PASID[19:0].
 - For ENQCMDs, the exit qualification contains the low 32 bits of the instruction’s source operand (which had been read from memory prior to PASID translation).
- For a VM exit due to an instruction timeout (Section 26.2), bit 0 indicates (if set) that the context of the virtual machine is invalid and that the VM should not be resumed. Bit 12 of the exit qualification reports “NMI unblocking due to IRET” (see Section 28.2.3). All other bits of the exit qualification are undefined.
- **Guest linear address.** For some VM exits, this field receives a linear address that pertains to the VM exit. The field is set for different VM exits as follows:
 - VM exits due to attempts to execute LMSW with a memory operand. In these cases, this field receives the linear address of that operand. Bits 63:32 are cleared if the logical processor was not in 64-bit mode before the VM exit.
 - VM exits due to attempts to execute INS or OUTS for which the relevant segment is usable (if the relevant segment is not usable, the value is undefined). (ES is always the relevant segment for INS; for OUTS, the relevant segment is DS unless overridden by an instruction prefix.) The linear address is the base address of relevant segment plus (E)DI (for INS) or (E)SI (for OUTS). Bits 63:32 are cleared if the logical processor was not in 64-bit mode before the VM exit.

Table 28-7. Exit Qualification for EPT Violations

Bit Position(s)	Contents
0	Set if the access causing the EPT violation was a data read. ¹
1	Set if the access causing the EPT violation was a data write. ¹
2	Set if the access causing the EPT violation was an instruction fetch.
3	The logical-AND of bit 0 in the EPT paging-structure entries used to translate the guest-physical address of the access causing the EPT violation (indicates whether the guest-physical address was readable). ²
4	The logical-AND of bit 1 in the EPT paging-structure entries used to translate the guest-physical address of the access causing the EPT violation (indicates whether the guest-physical address was writeable). ²
5	The logical-AND of bit 2 in the EPT paging-structure entries used to translate the guest-physical address of the access causing the EPT violation. ² If the “mode-based execute control for EPT” VM-execution control is 0, this indicates whether the guest-physical address was executable. If that control is 1, this indicates whether the guest-physical address was executable for supervisor-mode linear addresses.
6	If the “mode-based execute control” VM-execution control is 0, the value of this bit is undefined. If that control is 1, this bit is the logical-AND of bit 10 in the EPT paging-structure entries used to translate the guest-physical address of the access causing the EPT violation. In this case, it indicates whether the guest-physical address was executable for user-mode linear addresses. ³
7	Set if the guest linear-address field is valid. The guest linear-address field is valid for all EPT violations except those resulting from an attempt to load the guest PDPTes as part of the execution of the MOV CR instruction and those due to trace-address pre-translation (TAPT; Section 26.5.4).

Table 28-7. Exit Qualification for EPT Violations (Contd.)

Bit Position(s)	Contents
8	<p>If bit 7 is 1:</p> <ul style="list-style-type: none"> ▪ Set if the access causing the EPT violation is to a guest-physical address that is the translation of a linear address. ▪ Clear if the access causing the EPT violation is to a paging-structure entry as part of a page walk or the update of an accessed or dirty bit. <p>Reserved if bit 7 is 0 (cleared to 0).</p>
9	<p>If bit 7 is 1, bit 8 is 1, and the processor supports advanced VM-exit information for EPT violations,⁴ this bit is 0 if the linear address is a supervisor-mode linear address and 1 if it is a user-mode linear address. (If CR0.PG = 0, the translation of every linear address is a user-mode linear address and thus this bit will be 1.) Otherwise, this bit is undefined.</p>
10	<p>If bit 7 is 1, bit 8 is 1, and the processor supports advanced VM-exit information for EPT violations,⁴ this bit is 0 if paging translates the linear address to a read-only page and 1 if it translates to a read/write page. (If CR0.PG = 0, every linear address is read/write and thus this bit will be 1.) Otherwise, this bit is undefined.</p>
11	<p>If bit 7 is 1, bit 8 is 1, and the processor supports advanced VM-exit information for EPT violations,⁴ this bit is 0 if paging translates the linear address to an executable page and 1 if it translates to an execute-disable page. (If CR0.PG = 0, CR4.PAE = 0, or IA32_EFER.NXE = 0, every linear address is executable and thus this bit will be 0.) Otherwise, this bit is undefined.</p>
12	NMI unblocking due to IRET (see Section 28.2.3).
13	Set if the access causing the EPT violation was a shadow-stack access.
14	<p>If supervisor shadow-stack control is enabled (by setting bit 7 of EPTP), this bit is the same as bit 60 in the EPT paging-structure entry that maps the page of the guest-physical address of the access causing the EPT violation. Otherwise (or if translation of the guest-physical address terminates before reaching an EPT paging-structure entry that maps a page), this bit is undefined.</p>
15	This bit is set if the EPT violation was caused as a result of guest-paging verification. See Section 29.3.3.2.
16	<p>This bit is set if the access was asynchronous to instruction execution not the result of event delivery. The bit is set if the access is related to trace output by Intel PT (see Section 26.5.4), accesses related to PEBS on processors with the “EPT-friendly” enhancement (see Section 20.9.5), or to user-interrupt delivery (see Section 7.4.2). Otherwise, this bit is cleared.</p>
63:17	Not currently defined. Bits 63:32 exist only on processors that support Intel 64 architecture.

NOTES:

1. If accessed and dirty flags for EPT are enabled, processor accesses to guest paging-structure entries are treated as writes with regard to EPT violations (see Section 29.3.3.2). If such an access causes an EPT violation, the processor sets both bit 0 and bit 1 of the exit qualification.
2. Bits 5:3 are cleared to 0 if either (1) any of EPT paging-structure entries used to translate the guest-physical address of the access causing the EPT violation is not present; or (2) 4-level EPT is in use and the guest-physical address sets any bits in the range 51:48 (see Section 29.3.2).
3. Bit 6 is cleared to 0 if (1) the “mode-based execute control” VM-execution control is 1; and (2) either (a) any of EPT paging-structure entries used to translate the guest-physical address of the access causing the EPT violation is not present; or (b) 4-level EPT is in use and the guest-physical address sets any bits in the range 51:48 (see Section 29.3.2).
4. Software can determine whether advanced VM-exit information for EPT violations is supported by consulting the VMX capability MSR IA32_VMX_EPT_VPID_CAP (see Appendix A.10).

- VM exits due to EPT violations that set bit 7 of the exit qualification (see Table 28-7; these are all EPT violations except those resulting from an attempt to load the PDPTes as of execution of the MOV CR instruction and those due to TAPT). The linear address may translate to the guest-physical address whose access caused the EPT violation. Alternatively, translation of the linear address may reference a paging-

structure entry whose access caused the EPT violation. Bits 63:32 are cleared if the logical processor was not in 64-bit mode before the VM exit.

If the EPT violation occurred during execution of an instruction in enclave mode (and not during delivery of an event incident to enclave mode), bits 11:0 of this field are cleared.

- VM exits due to SPP-related events.
- If the “prematurely busy shadow stack” VM-exit control is 1, certain VM exits (besides those noted above) save the linear address that pertains to the VM exit if the VM exit caused a shadow stack to become prematurely busy (see Section 26.4.3). This is true for VM exits due for these reasons: EPT misconfiguration, page-modification log-full event, and instruction timeout. (A VM exit due to instruction timeout that sets bit 0 of the exit qualification, indicating that VM context is invalid, does not save a valid linear address.)
- For all other VM exits, the field is undefined.
- **Guest-physical address.** For a VM exit due to an EPT violation, an EPT misconfiguration, or an SPP-related event, this field receives the guest-physical address that caused the EPT violation or EPT misconfiguration. For all other VM exits, the field is undefined.

If the EPT violation or EPT misconfiguration occurred during execution of an instruction in enclave mode (and not during delivery of an event incident to enclave mode), bits 11:0 of this field are cleared.

28.2.2 Information for VM Exits Due to Vectored Events

Section 25.9.2 defines fields containing information for VM exits due to the following events: exceptions (including those generated by the instructions INT1, INT3, INTO, BOUND, UD0, UD1, and UD2); external interrupts that occur while the “acknowledge interrupt on exit” VM-exit control is 1; and non-maskable interrupts (NMIs).¹ Such VM exits include those that occur on an attempt at a task switch that causes an exception before generating the VM exit due to the task switch that causes the VM exit.

The following items detail the use of these fields:

- **VM-exit interruption information** (format given in Table 25-19). The following items detail how this field is established for VM exits due to these events:
 - For an exception, bits 7:0 receive the exception vector (at most 31). For an NMI, bits 7:0 are set to 2. For an external interrupt, bits 7:0 receive the vector.
 - Bits 10:8 are set to 0 (external interrupt), 2 (non-maskable interrupt), 3 (hardware exception), 5 (privileged software exception), or 6 (software exception). Hardware exceptions comprise all exceptions except the following:
 - Debug exceptions (#DB) generated by the INT1 instruction; these are privileged software exceptions. (Other debug exceptions are considered hardware exceptions, as are those caused by executions of INT1 in enclave mode.)
 - Breakpoint exceptions (#BP; generated by INT3) and overflow exceptions (#OF; generated by INTO); these are software exceptions. (A #BP that occurs in enclave mode is considered a hardware exception.)
- BOUND-range exceeded exceptions (#BR; generated by BOUND) and invalid opcode exceptions (#UD) generated by UD0, UD1, and UD2 are hardware exceptions.
- Bit 11 is set to 1 if the VM exit is caused by a hardware exception that would have delivered an error code on the stack. This bit is always 0 if the VM exit occurred while the logical processor was in real-address mode (CR0.PE=0).² If bit 11 is set to 1, the error code is placed in the VM-exit interruption error code (see below).
 - Bit 12 reports “NMI unblocking due to IRET”; see Section 28.2.3. The value of this bit is undefined if the VM exit is due to a double fault (the interruption type is hardware exception and the vector is 8).

1. INT1 and INT3 refer to the instructions with opcodes F1 and CC, respectively, and not to INT *n* with value 1 or 3 for *n*.

2. If the capability MSR IA32_VMX_CR0_FIXED0 reports that CR0.PE must be 1 in VMX operation, a logical processor cannot be in real-address mode unless the “unrestricted guest” VM-execution control and bit 31 of the primary processor-based VM-execution controls are both 1.

- Bits 30:13 are always set to 0.
- Bit 31 is always set to 1.

For other VM exits (including those due to external interrupts when the “acknowledge interrupt on exit” VM-exit control is 0), the field is marked invalid (by clearing bit 31) and the remainder of the field is undefined.

- **VM-exit interruption error code.**

- For VM exits that set both bit 31 (valid) and bit 11 (error code valid) in the VM-exit interruption-information field, this field receives the error code that would have been pushed on the stack had the event causing the VM exit been delivered normally through the IDT. The EXT bit is set in this field exactly when it would be set normally. For exceptions that occur during the delivery of double fault (if the IDT-vectoring information field indicates a double fault), the EXT bit is set to 1, assuming that (1) that the exception would produce an error code normally (if not incident to double-fault delivery) and (2) that the error code uses the EXT bit (not for page faults, which use a different format).
- For other VM exits, the value of this field is undefined.

28.2.3 Information About NMI Unblocking Due to IRET

A VM exit may occur during execution of the IRET instruction for reasons including the following: faults, EPT violations, page-modification log-full events, SPP-related events, or instruction timeouts.

An execution of IRET that commences while non-maskable interrupts (NMIs) are blocked will unblock NMIs even if a fault or VM exit occurs; the state saved by such a VM exit will indicate that NMIs were not blocked.

VM exits for the reasons enumerated above provide more information to software by saving a bit called “NMI unblocking due to IRET.” This bit is defined if (1) either the “NMI exiting” VM-execution control is 0 or the “virtual NMIs” VM-execution control is 1; (2) the VM exit does not set the valid bit in the IDT-vectoring information field (see Section 28.2.4); and (3) the VM exit is not due to a double fault. In these cases, the bit is defined as follows:

- The bit is 1 if the VM exit resulted from a memory access as part of execution of the IRET instruction and one of the following holds:
 - The “virtual NMIs” VM-execution control is 0 and blocking by NMI (see Table 25-3) was in effect before execution of IRET.
 - The “virtual NMIs” VM-execution control is 1 and virtual-NMI blocking was in effect before execution of IRET.
- The bit is 0 for all other relevant VM exits.

For VM exits due to faults, NMI unblocking due to IRET is saved in bit 12 of the VM-exit interruption-information field (Section 28.2.2). For VM exits due to EPT violations, page-modification log-full events, SPP-related events, and instruction timeouts, NMI unblocking due to IRET is saved in bit 12 of the exit qualification (Section 28.2.1).

(Executions of IRET may also incur VM exits due to APIC accesses and EPT misconfigurations. These VM exits do not report information about NMI unblocking due to IRET.)

28.2.4 Information for VM Exits During Event Delivery

Section 25.9.3 defined fields containing information for VM exits that occur while delivering an event through the IDT and as a result of any of the following cases:¹

- A fault occurs during event delivery and causes a VM exit (because the bit associated with the fault is set to 1 in the exception bitmap).
- A task switch is invoked through a task gate in the IDT. The VM exit occurs due to the task switch only after the initial checks of the task switch pass (see Section 26.4.2).
- Event delivery causes an APIC-access VM exit (see Section 30.4).

1. This includes the case in which a VM exit occurs while delivering a software interrupt (INT *n*) through the 16-bit IVT (interrupt vector table) that is used in virtual-8086 mode with virtual-machine extensions (if RFLAGS.VM = CR4.VME = 1).

- An EPT violation, EPT misconfiguration, page-modification log-full event, or SPP-related event that occurs during event delivery.
- Any of the above VM exits that occur during user-interrupt notification processing (see Section 7.5.2). Such VM exits will be treated as if they occurred during delivery of an external interrupt with the vector UINV.

These fields are used for VM exits that occur during delivery of events injected as part of VM entry (see Section 27.6.1.2).

A VM exit is not considered to occur during event delivery in any of the following circumstances:

- The original event causes the VM exit directly (for example, because the original event is a non-maskable interrupt (NMI) and the “NMI exiting” VM-execution control is 1).
- The original event results in a double-fault exception that causes the VM exit directly.
- The VM exit occurred as a result of fetching the first instruction of the handler invoked by the event delivery.
- The VM exit is caused by a triple fault.
- The original event was a software interrupt (INT n) executed in virtual-8086 mode with EFLAGS.IOPL < 3 and the VM exit was due to a general-protection exception (#GP) that occurred because either CR4.VME = 0 or bit n of the software interrupt redirection bit map in the TSS is set.

The following items detail the use of these fields:

- IDT-vectoring information (format given in Table 25-20). The following items detail how this field is established for VM exits that occur during event delivery:
 - If the VM exit occurred during delivery of an exception, bits 7:0 receive the exception vector (at most 31). If the VM exit occurred during delivery of an NMI, bits 7:0 are set to 2. If the VM exit occurred during delivery of an external interrupt, bits 7:0 receive the vector.
 - Bits 10:8 are set to indicate the type of event that was being delivered when the VM exit occurred: 0 (external interrupt), 2 (non-maskable interrupt), 3 (hardware exception), 4 (software interrupt), 5 (privileged software interrupt), or 6 (software exception).

Hardware exceptions comprise all exceptions except the following:¹

- Debug exceptions (#DB) generated by the INT1 instruction; these are privileged software exceptions. (Other debug exceptions are considered hardware exceptions, as are those caused by executions of INT1 in enclave mode.)
- Breakpoint exceptions (#BP; generated by INT3) and overflow exceptions (#OF; generated by INTO); these are software exceptions. (A #BP that occurs in enclave mode is considered a hardware exception.)

BOUND-range exceeded exceptions (#BR; generated by BOUND) and invalid opcode exceptions (#UD) generated by UD0, UD1, and UD2 are hardware exceptions.

- Bit 11 is set to 1 if the VM exit occurred during delivery of a hardware exception that would have delivered an error code on the stack. This bit is always 0 if the VM exit occurred while the logical processor was in real-address mode (CR0.PE=0).² If bit 11 is set to 1, the error code is placed in the IDT-vectoring error code (see below).
- Bit 12 is undefined.
- Bits 30:13 are always set to 0.
- Bit 31 is always set to 1.

For other VM exits, the field is marked invalid (by clearing bit 31) and the remainder of the field is undefined.

- IDT-vectoring error code.

1. In the following items, INT1 and INT3 refer to the instructions with opcodes F1 and CC, respectively, and not to INT n with value 1 or 3 for n .

2. If the capability MSR IA32_VMX_CR0_FIXED0 reports that CR0.PE must be 1 in VMX operation, a logical processor cannot be in real-address mode unless the “unrestricted guest” VM-execution control and bit 31 of the primary processor-based VM-execution controls are both 1.

- For VM exits that set both bit 31 (valid) and bit 11 (error code valid) in the IDT-vectoring information field, this field receives the error code that would have been pushed on the stack by the event that was being delivered through the IDT at the time of the VM exit. The EXT bit is set in this field when it would be set normally.
- For other VM exits, the value of this field is undefined.

28.2.5 Information for VM Exits Due to Instruction Execution

Section 25.9.4 defined fields containing information for VM exits that occur due to instruction execution. (The VM-exit instruction length is also used for VM exits that occur during the delivery of a software interrupt or software exception.) The following items detail their use.

- **VM-exit instruction length.** This field is used in the following cases:
 - For fault-like VM exits due to attempts to execute one of the following instructions that cause VM exits unconditionally (see Section 26.1.2) or based on the settings of VM-execution controls (see Section 26.1.3): CLTS, CPUID, ENCLS, GETSEC, HLT, IN, INS, INVND, INVEPT, INVLPG, INVPCID, INVVPID, LGDT, LIDT, LLDT, LMSW, LOADIWKEY, LTR, MONITOR, MOV CR, MOV DR, MWAIT, OUT, OUTS, PAUSE, PCONFIG, RDMSR, RDPIC, RDRAND, RDSEED, RDTSC, RDTSCP, RSM, SGDT, SIDT, SLDT, STR, TPAUSE, UMWAIT, VMCALL, VMCLEAR, VMLAUNCH, VMPTRLD, VMPTRST, VMREAD, VMRESUME, VMWRITE, VMXOFF, VMXON, WBINVD, WBNOINVD, WRMSR, XRSTORS, XSETBV, and XSAVES.¹
 - For VM exits due to software exceptions (those generated by executions of INT3 or INTO) or privileged software exceptions (those generated by executions of INT1).
 - For VM exits due to faults encountered during delivery of a software interrupt, privileged software exception, or software exception.
 - For VM exits due to attempts to effect a task switch via instruction execution. These are VM exits that produce an exit reason indicating task switch and either of the following:
 - An exit qualification indicating execution of CALL, IRET, or JMP instruction.
 - An exit qualification indicating a task gate in the IDT and an IDT-vectoring information field indicating that the task gate was encountered during delivery of a software interrupt, privileged software exception, or software exception.
 - For APIC-access VM exits and for VM exits caused by EPT violations, page-modification log-full events, and SPP-related events encountered during delivery of a software interrupt, privileged software exception, or software exception.²
 - For VM exits due to executions of VMFUNC that fail because one of the following is true:
 - EAX indicates a VM function that is not enabled (the bit at position EAX is 0 in the VM-function controls; see Section 26.5.6.2).
 - EAX = 0 and either ECX ≥ 512 or the value of ECX selects an invalid tentative EPTP value (see Section 26.5.6.3).

In all the above cases, this field receives the length in bytes (1–15) of the instruction (including any instruction prefixes) whose execution led to the VM exit (see the next paragraph for one exception).

The cases of VM exits encountered during delivery of a software interrupt, privileged software exception, or software exception include those encountered during delivery of events injected as part of VM entry (see Section 27.6.1.2). If the original event was injected as part of VM entry, this field receives the value of the VM-entry instruction length.

All VM exits other than those listed in the above items leave this field undefined.

-
1. This item applies only to fault-like VM exits. It does not apply to trap-like VM exits following executions of the MOV to CR8 instruction when the “use TPR shadow” VM-execution control is 1 or to those following executions of the WRMSR instruction when the “virtualize x2APIC mode” VM-execution control is 1.
 2. The VM-exit instruction-length field is not defined following APIC-access VM exits resulting from physical accesses (see Section 30.4.6) even if encountered during delivery of a software interrupt, privileged software exception, or software exception.

If the VM exit occurred in enclave mode, this field is cleared (none of the previous items apply).

Table 28-8. Format of the VM-Exit Instruction-Information Field as Used for INS and OUTS

Bit Position(s)	Content
6:0	Undefined.
9:7	Address size: 0: 16-bit 1: 32-bit 2: 64-bit (used only on processors that support Intel 64 architecture) Other values not used.
14:10	Undefined.
17:15	Segment register: 0: ES 1: CS 2: SS 3: DS 4: FS 5: GS Other values not used. Undefined for VM exits due to execution of INS.
31:18	Undefined.

- **VM-exit instruction information.** For VM exits due to attempts to execute INS, INVEPT, INVPCID, INVVPID, LIDT, LGDT, LLDT, LOADIWKEY, LTR, OUTS, RDRAND, RDSEED, SIDT, SGDT, SLDT, STR, TPAUSE, UMWAIT, VMCLEAR, VMPTRLD, VMPTRST, VMREAD, VMWRITE, VMXON, XRSTORS, or XSAVES, this field receives information about the instruction that caused the VM exit. The format of the field depends on the identity of the instruction causing the VM exit:

 - For VM exits due to attempts to execute INS or OUTS, the field has the format is given in Table 28-8.¹
 - For VM exits due to attempts to execute INVEPT, INVPCID, or INVVPID, the field has the format is given in Table 28-9.
 - For VM exits due to attempts to execute LIDT, LGDT, SIDT, or SGDT, the field has the format is given in Table 28-10.
 - For VM exits due to attempts to execute LLDT, LTR, SLDT, or STR, the field has the format is given in Table 28-11.
 - For VM exits due to attempts to execute RDRAND, RDSEED, TPAUSE, or UMWAIT, the field has the format is given in Table 28-12.
 - For VM exits due to attempts to execute VMCLEAR, VMPTRLD, VMPTRST, VMXON, XRSTORS, or XSAVES, the field has the format is given in Table 28-13.
 - For VM exits due to attempts to execute VMREAD or VMWRITE, the field has the format is given in Table 28-14.
 - For VM exits due to attempts to execute LOADIWKEY, the field has the format is given in Table 28-15.

For all other VM exits, the field is undefined, unless the VM exit occurred in enclave mode, in which case the field is cleared.
- **I/O RCX, I/O RSI, I/O RDI, I/O RIP.** These fields are undefined except for SMM VM exits due to system-management interrupts (SMIs) that arrive immediately after retirement of I/O instructions. See Section 32.15.2.3. Note that, if the VM exit occurred in enclave mode, these fields are all cleared.

1. The format of the field was undefined for these VM exits on the first processors to support the virtual-machine extensions. Software can determine whether the format specified in Table 28-8 is used by consulting the VMX capability MSR IA32_VMX_BASIC (see Appendix A.1).

Table 28-9. Format of the VM-Exit Instruction-Information Field as Used for INVEPT, INVPCID, and INVVPID

Bit Position(s)	Content
1:0	Scaling: 0: no scaling 1: scale by 2 2: scale by 4 3: scale by 8 (used only on processors that support Intel 64 architecture) Undefined for instructions with no index register (bit 22 is set).
6:2	Undefined.
9:7	Address size: 0: 16-bit 1: 32-bit 2: 64-bit (used only on processors that support Intel 64 architecture) Other values not used.
10	Cleared to 0.
14:11	Undefined.
17:15	Segment register: 0: ES 1: CS 2: SS 3: DS 4: FS 5: GS Other values not used.
21:18	IndexReg: 0 = RAX 1 = RCX 2 = RDX 3 = RBX 4 = RSP 5 = RBP 6 = RSI 7 = RDI 8-15 represent R8-R15, respectively (used only on processors that support Intel 64 architecture) Undefined for instructions with no index register (bit 22 is set).
22	IndexReg invalid (0 = valid; 1 = invalid)
26:23	BaseReg (encoded as IndexReg above) Undefined for memory instructions with no base register (bit 27 is set).
27	BaseReg invalid (0 = valid; 1 = invalid)
31:28	Reg2 (same encoding as IndexReg above)

Table 28-10. Format of the VM-Exit Instruction-Information Field as Used for LIDT, LGDT, SIDT, or SGDT

Bit Position(s)	Content
1:0	Scaling: 0: no scaling 1: scale by 2 2: scale by 4 3: scale by 8 (used only on processors that support Intel 64 architecture) Undefined for instructions with no index register (bit 22 is set).

Table 28-10. Format of the VM-Exit Instruction-Information Field as Used for LIDT, LGDT, SIDT, or SGDT (Contd.)

Bit Position(s)	Content
6:2	Undefined.
9:7	Address size: 0: 16-bit 1: 32-bit 2: 64-bit (used only on processors that support Intel 64 architecture) Other values not used.
10	Cleared to 0.
11	Operand size: 0: 16-bit 1: 32-bit Undefined for VM exits from 64-bit mode.
14:12	Undefined.
17:15	Segment register: 0: ES 1: CS 2: SS 3: DS 4: FS 5: GS Other values not used.
21:18	IndexReg: 0 = RAX 1 = RCX 2 = RDX 3 = RBX 4 = RSP 5 = RBP 6 = RSI 7 = RDI 8-15 represent R8-R15, respectively (used only on processors that support Intel 64 architecture) Undefined for instructions with no index register (bit 22 is set).
22	IndexReg invalid (0 = valid; 1 = invalid)
26:23	BaseReg (encoded as IndexReg above) Undefined for instructions with no base register (bit 27 is set).
27	BaseReg invalid (0 = valid; 1 = invalid)
29:28	Instruction identity: 0: SGDT 1: SIDT 2: LGDT 3: LIDT
31:30	Undefined.

Table 28-11. Format of the VM-Exit Instruction-Information Field as Used for LLDT, LTR, SLDT, and STR

Bit Position(s)	Content
1:0	Scaling: 0: no scaling 1: scale by 2 2: scale by 4 3: scale by 8 (used only on processors that support Intel 64 architecture) Undefined for register instructions (bit 10 is set) and for memory instructions with no index register (bit 10 is clear and bit 22 is set).
2	Undefined.
6:3	Reg1: 0 = RAX 1 = RCX 2 = RDX 3 = RBX 4 = RSP 5 = RBP 6 = RSI 7 = RDI 8-15 represent R8-R15, respectively (used only on processors that support Intel 64 architecture) Undefined for memory instructions (bit 10 is clear).
9:7	Address size: 0: 16-bit 1: 32-bit 2: 64-bit (used only on processors that support Intel 64 architecture) Other values not used. Undefined for register instructions (bit 10 is set).
10	Mem/Reg (0 = memory; 1 = register).
14:11	Undefined.
17:15	Segment register: 0: ES 1: CS 2: SS 3: DS 4: FS 5: GS Other values not used. Undefined for register instructions (bit 10 is set).
21:18	IndexReg (encoded as Reg1 above) Undefined for register instructions (bit 10 is set) and for memory instructions with no index register (bit 10 is clear and bit 22 is set).
22	IndexReg invalid (0 = valid; 1 = invalid) Undefined for register instructions (bit 10 is set).
26:23	BaseReg (encoded as Reg1 above) Undefined for register instructions (bit 10 is set) and for memory instructions with no base register (bit 10 is clear and bit 27 is set).
27	BaseReg invalid (0 = valid; 1 = invalid) Undefined for register instructions (bit 10 is set).

Table 28-11. Format of the VM-Exit Instruction-Information Field as Used for LLDT, LTR, SLDT, and STR (Contd.)

Bit Position(s)	Content
29:28	Instruction identity: 0: SLDT 1: STR 2: LLDT 3: LTR
31:30	Undefined.

Table 28-12. Format of the VM-Exit Instruction-Information Field as Used for RDRAND, RDSEED, TPAUSE, and UMWAIT

Bit Position(s)	Content
2:0	Undefined.
6:3	Operand register (destination for RDRAND and RDSEED; source for TPAUSE and UMWAIT): 0 = RAX 1 = RCX 2 = RDX 3 = RBX 4 = RSP 5 = RBP 6 = RSI 7 = RDI 8-15 represent R8-R15, respectively (used only on processors that support Intel 64 architecture)
10:7	Undefined.
12:11	Operand size: 0: 16-bit 1: 32-bit 2: 64-bit The value 3 is not used.
31:13	Undefined.

Table 28-13. Format of the VM-Exit Instruction-Information Field as Used for VMCLEAR, VMPTRLD, VMPTRST, VMXON, XRSTORS, and XSAVES

Bit Position(s)	Content
1:0	Scaling: 0: no scaling 1: scale by 2 2: scale by 4 3: scale by 8 (used only on processors that support Intel 64 architecture) Undefined for instructions with no index register (bit 22 is set).
6:2	Undefined.
9:7	Address size: 0: 16-bit 1: 32-bit 2: 64-bit (used only on processors that support Intel 64 architecture) Other values not used.
10	Cleared to 0.

Table 28-13. Format of the VM-Exit Instruction-Information Field as Used for VMCLEAR, VMPTRLD, VMPTRST, VMXON, XRSTORS, and XSAVES (Contd.)

Bit Position(s)	Content
14:11	Undefined.
17:15	Segment register: 0: ES 1: CS 2: SS 3: DS 4: FS 5: GS Other values not used.
21:18	IndexReg: 0 = RAX 1 = RCX 2 = RDX 3 = RBX 4 = RSP 5 = RBP 6 = RSI 7 = RDI 8-15 represent R8-R15, respectively (used only on processors that support Intel 64 architecture) Undefined for instructions with no index register (bit 22 is set).
22	IndexReg invalid (0 = valid; 1 = invalid)
26:23	BaseReg (encoded as IndexReg above) Undefined for instructions with no base register (bit 27 is set).
27	BaseReg invalid (0 = valid; 1 = invalid)
31:28	Undefined.

Table 28-14. Format of the VM-Exit Instruction-Information Field as Used for VMREAD and VMWRITE

Bit Position(s)	Content
1:0	Scaling: 0: no scaling 1: scale by 2 2: scale by 4 3: scale by 8 (used only on processors that support Intel 64 architecture) Undefined for register instructions (bit 10 is set) and for memory instructions with no index register (bit 10 is clear and bit 22 is set).
2	Undefined.

Table 28-14. Format of the VM-Exit Instruction-Information Field as Used for VMREAD and VMWRITE (Contd.)

Bit Position(s)	Content
6:3	Reg1: 0 = RAX 1 = RCX 2 = RDX 3 = RBX 4 = RSP 5 = RBP 6 = RSI 7 = RDI 8-15 represent R8-R15, respectively (used only on processors that support Intel 64 architecture) Undefined for memory instructions (bit 10 is clear).
9:7	Address size: 0: 16-bit 1: 32-bit 2: 64-bit (used only on processors that support Intel 64 architecture) Other values not used. Undefined for register instructions (bit 10 is set).
10	Mem/Reg (0 = memory; 1 = register).
14:11	Undefined.
17:15	Segment register: 0: ES 1: CS 2: SS 3: DS 4: FS 5: GS Other values not used. Undefined for register instructions (bit 10 is set).
21:18	IndexReg (encoded as Reg1 above) Undefined for register instructions (bit 10 is set) and for memory instructions with no index register (bit 10 is clear and bit 22 is set).
22	IndexReg invalid (0 = valid; 1 = invalid) Undefined for register instructions (bit 10 is set).
26:23	BaseReg (encoded as Reg1 above) Undefined for register instructions (bit 10 is set) and for memory instructions with no base register (bit 10 is clear and bit 27 is set).
27	BaseReg invalid (0 = valid; 1 = invalid) Undefined for register instructions (bit 10 is set).
31:28	Reg2 (same encoding as Reg1 above)

Table 28-15. Format of the VM-Exit Instruction-Information Field as Used for LOADIWKEY

Bit Position(s)	Content
2:0	Undefined.
6:3	Reg1: identifies the first XMM register operand (XMM0-XMM15; values 8-15 are used only on processors that support Intel 64 architecture).
30:7	Undefined.
31:28	Reg2: identifies the second XMM register operand (see above).

28.3 SAVING GUEST STATE

VM exits save certain components of processor state into corresponding fields in the guest-state area of the VMCS (see Section 25.4). On processors that support Intel 64 architecture, the full value of each natural-width field (see Section 25.11.2) is saved regardless of the mode of the logical processor before and after the VM exit.

In general, the state saved is that which was in the logical processor at the time the VM exit commences. See Section 28.1 for a discussion of which architectural updates occur at that time.

Section 28.3.1 through Section 28.3.4 provide details for how various components of processor state are saved. These sections reference VMCS fields that correspond to processor state. Unless otherwise stated, these references are to fields in the guest-state area.

28.3.1 Saving Control Registers, Debug Registers, and MSRs

Contents of certain control registers, debug registers, and MSRs are saved as follows:

- The contents of CR0, CR3, CR4, and the IA32_SYSENTER_CS, IA32_SYSENTER_ESP, and IA32_SYSENTER_EIP MSRs are saved into the corresponding fields. Bits 63:32 of the IA32_SYSENTER_CS MSR are not saved. On processors that do not support Intel 64 architecture, bits 63:32 of the IA32_SYSENTER_ESP and IA32_SYSENTER_EIP MSRs are not saved.
- If the “save debug controls” VM-exit control is 1, the contents of DR7 and the IA32_DEBUGCTL MSR are saved into the corresponding fields. The first processors to support the virtual-machine extensions supported only the 1-setting of this control and thus always saved data into these fields.
- If the “save IA32_PAT” VM-exit control is 1, the contents of the IA32_PAT MSR are saved into the corresponding field.
- If the “save IA32_EFER” VM-exit control is 1, the contents of the IA32_EFER MSR are saved into the corresponding field.
- If the processor supports either the 1-setting of the “load IA32_BNDCFGS” VM-entry control or that of the “clear IA32_BNDCFGS” VM-exit control, the contents of the IA32_BNDCFGS MSR are saved into the corresponding field.
- If the processor supports either the 1-setting of the “load IA32_RTIT_CTL” VM-entry control or that of the “clear IA32_RTIT_CTL” VM-exit control, the contents of the IA32_RTIT_CTL MSR are saved into the corresponding field.
- If the processor supports the 1-setting of the “load CET” VM-entry control, the contents of the IA32_S_CET and IA32_INTERRUPT_SSP_TABLE_ADDR MSRs are saved into the corresponding fields. On processors that do not support Intel 64 architecture, bits 63:32 of these MSRs are not saved.
- If the processor supports either the 1-setting of the “load guest IA32_LBR_CTL” VM-entry control or that of the “clear IA32_LBR_CTL” VM-exit control, the contents of the IA32_LBR_CTL MSR are saved into the corresponding field.
- If the processor supports the 1-setting of the “load PKRS” VM-entry control, the contents of the IA32_PKRS MSR are saved into the corresponding field.
- If a processor supports user interrupts, every VM exit saves UINV into the guest UINV field in the VMCS (bits 15:8 of the field are cleared).
- If the “save IA32_PERF_GLOBAL_CTL” VM-exit control is 1, the contents of the IA32_PERF_GLOBAL_CTL MSR are saved into the corresponding field.
- The value of the SMBASE field is undefined after all VM exits except SMM VM exits. See Section 32.15.2.

28.3.2 Saving Segment Registers and Descriptor-Table Registers

For each segment register (CS, SS, DS, ES, FS, GS, LDTR, or TR), the values saved for the base-address, segment-limit, and access rights are based on whether the register was unusable (see Section 25.4.1) before the VM exit:

- If the register was unusable, the values saved into the following fields are undefined: (1) base address; (2) segment limit; and (3) bits 7:0 and bits 15:12 in the access-rights field. The following exceptions apply:

- CS.
 - The base-address and segment-limit fields are saved.
 - The L, D, and G bits are saved in the access-rights field.
- SS.
 - DPL is saved in the access-rights field.
 - On processors that support Intel 64 architecture, bits 63:32 of the value saved for the base address are always zero.
- DS and ES. On processors that support Intel 64 architecture, bits 63:32 of the values saved for the base addresses are always zero.
- FS and GS. The base-address field is saved.
- LDTR. The value saved for the base address is always canonical.
- If the register was not unusable, the values saved into the following fields are those which were in the register before the VM exit: (1) base address; (2) segment limit; and (3) bits 7:0 and bits 15:12 in access rights.
- Bits 31:17 and 11:8 in the access-rights field are always cleared. Bit 16 is set to 1 if and only if the segment is unusable.

The contents of the GDTR and IDTR registers are saved into the corresponding base-address and limit fields.

28.3.3 Saving RIP, RSP, RFLAGS, and SSP

The contents of the RIP, RSP, RFLAGS, and SSP (shadow-stack pointer) registers are saved as follows:

- The value saved in the RIP field is determined by the nature and cause of the VM exit:
 - If the VM exit occurred in enclave mode, the value saved is the AEP of interrupted enclave thread (the remaining items do not apply).
 - If the VM exit occurs due to by an attempt to execute an instruction that causes VM exits unconditionally or that has been configured to cause a VM exit via the VM-execution controls, the value saved references that instruction.
 - If the VM exit is caused by an occurrence of an INIT signal, a start-up IPI (SIPI), or system-management interrupt (SMI), the value saved is that which was in RIP before the event occurred.
 - If the VM exit occurs due to the 1-setting of either the “interrupt-window exiting” VM-execution control or the “NMI-window exiting” VM-execution control, the value saved is that which would be in the register had the VM exit not occurred.
 - If the VM exit is due to an external interrupt, non-maskable interrupt (NMI), or hardware exception (as defined in Section 28.2.2), the value saved is the return pointer that would have been saved (either on the stack had the event been delivered through a trap or interrupt gate,¹ or into the old task-state segment had the event been delivered through a task gate).
 - If the VM exit is due to a triple fault, the value saved is the return pointer that would have been saved (either on the stack had the event been delivered through a trap or interrupt gate, or into the old task-state segment had the event been delivered through a task gate) had delivery of the double fault not encountered the nested exception that caused the triple fault.
 - If the VM exit is due to a software exception (due to an execution of INT3 or INTO) or a privileged software exception (due to an execution of INT1), the value saved references the INT3, INTO, or INT1 instruction that caused that exception.
 - Suppose that the VM exit is due to a task switch that was caused by execution of CALL, IRET, or JMP or by execution of a software interrupt (INT *n*), software exception (due to execution of INT3 or INTO), or privileged software exception (due to execution of INT1) that encountered a task gate in the IDT. The value saved references the instruction that caused the task switch (CALL, IRET, JMP, INT *n*, INT3, INTO, INT1).

1. The reference here is to the full value of RIP before any truncation that would occur had the stack width been only 32 bits or 16 bits.

- Suppose that the VM exit is due to a task switch that was caused by a task gate in the IDT that was encountered for any reason except the direct access by a software interrupt or software exception. The value saved is that which would have been saved in the old task-state segment had the task switch completed normally.
- If the VM exit is due to an execution of MOV to CR8 or WRMSR that reduced the value of bits 7:4 of VTPR (see Section 30.1.1) below that of TPR threshold VM-execution control field (see Section 30.1.2), the value saved references the instruction following the MOV to CR8 or WRMSR.
- If the VM exit was caused by APIC-write emulation (see Section 30.4.3.2) that results from an APIC access as part of instruction execution, the value saved references the instruction following the one whose execution caused the APIC-write emulation.
- The contents of the RSP register are saved into the RSP field.
- With the exception of the resume flag (RF; bit 16), the contents of the RFLAGS register is saved into the RFLAGS field. RFLAGS.RF is saved as follows:
 - If the VM exit occurred in enclave mode, the value saved is 0 (the remaining items do not apply).
 - If the VM exit is caused directly by an event that would normally be delivered through the IDT, the value saved is that which would appear in the saved RFLAGS image (either that which would be saved on the stack had the event been delivered through a trap or interrupt gate¹ or into the old task-state segment had the event been delivered through a task gate) had the event been delivered through the IDT. See below for VM exits due to task switches caused by task gates in the IDT.
 - If the VM exit is caused by a triple fault, the value saved is that which the logical processor would have in RF in the RFLAGS register had the triple fault taken the logical processor to the shutdown state.
 - If the VM exit is caused by a task switch (including one caused by a task gate in the IDT), the value saved is that which would have been saved in the RFLAGS image in the old task-state segment (TSS) had the task switch completed normally without exception.
 - If the VM exit is caused by an attempt to execute an instruction that unconditionally causes VM exits or one that was configured to do with a VM-execution control, the value saved is 0.²
 - For APIC-access VM exits and for VM exits caused by EPT violations, EPT misconfigurations, page-modification log-full events, or SPP-related events, the value saved depends on whether the VM exit occurred during delivery of an event through the IDT:
 - If the VM exit stored 0 for bit 31 for IDT-vectoring information field (because the VM exit did not occur during delivery of an event through the IDT; see Section 28.2.4), the value saved is 1.
 - If the VM exit stored 1 for bit 31 for IDT-vectoring information field (because the VM exit did occur during delivery of an event through the IDT), the value saved is the value that would have appeared in the saved RFLAGS image had the event been delivered through the IDT (see above).
 - For all other VM exits, the value saved is the value RFLAGS.RF had before the VM exit occurred.
- If the processor supports the 1-setting of the “load CET” VM-entry control, the contents of the SSP register are saved into the SSP field.

28.3.4 Saving Non-Register State

Information corresponding to guest non-register state is saved as follows:

-
1. The reference here is to the full value of RFLAGS before any truncation that would occur had the stack width been only 32 bits or 16 bits.
 2. This is true even if RFLAGS.RF was 1 before the instruction was executed. If, in response to such a VM exit, a VM monitor re-enters the guest to re-execute the instruction that caused the VM exit (for example, after clearing the VM-execution control that caused the VM exit), the instruction may encounter a code breakpoint that has already been processed. A VM monitor can avoid this by setting the guest value of RFLAGS.RF to 1 before resuming guest software.

- The activity-state field is saved with the logical processor's activity state before the VM exit.¹ See Section 28.1 for details of how events leading to a VM exit may affect the activity state. If the VM exit occurred during user-interrupt notification processing (see Section 7.5.2) and the logical processor would have entered the HLT state following user-interrupt notification processing, the saved activity state is "HLT".
- The interruptibility-state field is saved to reflect the logical processor's interruptibility before the VM exit.
 - See Section 28.1 for details of how events leading to a VM exit may affect this state.
 - VM exits that end outside system-management mode (SMM) save bit 2 (blocking by SMI) as 0 regardless of the state of such blocking before the VM exit.
 - Bit 3 (blocking by NMI) is treated specially if the "virtual NMIs" VM-execution control is 1. In this case, the value saved for this field does not indicate the blocking of NMIs but rather the state of virtual-NMI blocking.
 - Bit 4 (enclave interruption) is set to 1 if the VM exit occurred while the logical processor was in enclave mode.

Such VM exits includes those caused by interrupts, non-maskable interrupts, system-management interrupts, INIT signals, and exceptions occurring in enclave mode as well as exceptions encountered during the delivery of such events incident to enclave mode.

A VM exit that is incident to delivery of an event injected by VM entry leaves this bit unmodified.

- The pending debug exceptions field is saved as clear for all VM exits except the following:
 - A VM exit caused by an INIT signal, a machine-check exception, or a system-management interrupt (SMI).
 - A VM exit with basic exit reason "TPR below threshold",² "virtualized EOI", "APIC write", "monitor trap flag," or "bus-lock detected."
 - A VM exit due to trace-address pre-translation (TAPT; see Section 26.5.4) or due to accesses related to PEBS on processors with the "EPT-friendly" enhancement (see Section 20.9.5). Such VM exits can have basic exit reason "APIC access," "EPT violation," "EPT misconfiguration," "page-modification log full," or "SPP-related event." When due to TAPT or PEBS, these VM exits (with the exception of those due to EPT misconfigurations) set bit 16 of the exit qualification, indicating that they are asynchronous to instruction execution and not part of event delivery.
 - VM exits that are not caused by debug exceptions and that occur while there is MOV-SS blocking of debug exceptions.

For VM exits that do not clear the field, the value saved is determined as follows:

- Each of bits 3:0 may be set if it corresponds to a matched breakpoint. This may be true even if the corresponding breakpoint is not enabled in DR7.
- Suppose that a VM exit is due to an INIT signal, a machine-check exception, or an SMI; or that a VM exit has basic exit reason "TPR below threshold" or "monitor trap flag." In this case, the value saved sets bits corresponding to the causes of any debug exceptions that were pending at the time of the VM exit.

If the VM exit occurs immediately after VM entry, the value saved may match that which was loaded on VM entry (see Section 27.7.3). Otherwise, the following items apply:

- Bit 12 (enabled breakpoint) is set to 1 in any of the following cases:
 - If there was at least one matched data or I/O breakpoint that was enabled in DR7.
 - If it had been set on VM entry, causing there to be valid pending debug exceptions (see Section 27.7.3) and the VM exit occurred before those exceptions were either delivered or lost.
 - If the XBEGIN instruction was executed immediately before the VM exit and advanced debugging of RTM transactional regions had been enabled (see Section 16.3.7, "RTM-Enabled Debugger Support," of Intel® 64 and IA-32 Architectures Software Developer's Manual, Volume 1). (This does not apply to VM exits with basic exit reason "monitor trap flag.")
 - If a bus lock was asserted while CPL > 0 and OS bus-lock detection was enabled.

1. If this activity state was an inactive state resulting from execution of a specific instruction (HLT or MWAIT), the value saved for RIP by that VM exit will reference the following instruction.

2. This item includes VM exits that occur as a result of certain VM entries (Section 27.7.7).

In other cases, bit 12 is cleared to 0.

- Bit 14 (BS) is set if RFLAGS.TF = 1 in either of the following cases:
 - IA32_DEBUGCTL.BTF = 0 and the cause of a pending debug exception was the execution of a single instruction.
 - IA32_DEBUGCTL.BTF = 1 and the cause of a pending debug exception was a taken branch.
- Bit 16 (RTM) is set if a debug exception (#DB) or a breakpoint exception (#BP) occurred inside an RTM region while advanced debugging of RTM transactional regions had been enabled. (This does not apply to VM exits with basic exit reason “monitor trap flag.”)
- Suppose that a VM exit is due to another reason (but not a debug exception) and occurs while there is MOV-SS blocking of debug exceptions. In this case, the value saved sets bits corresponding to the causes of any debug exceptions that were pending at the time of the VM exit. If the VM exit occurs immediately after VM entry (no instructions were executed in VMX non-root operation), the value saved may match that which was loaded on VM entry (see Section 27.7.3). Otherwise, the following items apply:
 - Bit 12 (enabled breakpoint) is set to 1 if there was at least one matched data or I/O breakpoint that was enabled in DR7. Bit 12 is also set if it had been set on VM entry, causing there to be valid pending debug exceptions (see Section 27.7.3) and the VM exit occurred before those exceptions were either delivered or lost. In other cases, bit 12 is cleared to 0.
 - The setting of bit 14 (BS) is implementation-specific. However, it is not set if RFLAGS.TF = 0 or IA32_DEBUGCTL.BTF = 1.
- The reserved bits in the field are cleared.
- If the “save VMX-preemption timer value” VM-exit control is 1, the value of timer is saved into the VMX-preemption timer-value field. This is the value loaded from this field on VM entry as subsequently decremented (see Section 26.5.1). VM exits due to timer expiration save the value 0. Other VM exits may also save the value 0 if the timer expired during VM exit. (If the “save VMX-preemption timer value” VM-exit control is 0, VM exit does not modify the value of the VMX-preemption timer-value field.)
- If the logical processor supports the 1-setting of the “enable EPT” VM-execution control, values are saved into the four (4) PDPTE fields as follows:
 - If the “enable EPT” VM-execution control is 1 and the logical processor was using PAE paging at the time of the VM exit, the PDPTE values currently in use are saved:¹
 - The values saved into bits 11:9 of each of the fields is undefined.
 - If the value saved into one of the fields has bit 0 (present) clear, the value saved into bits 63:1 of that field is undefined. That value need not correspond to the value that was loaded by VM entry or to any value that might have been loaded in VMX non-root operation.
 - If the value saved into one of the fields has bit 0 (present) set, the value saved into bits 63:12 of the field is a guest-physical address.
 - If the “enable EPT” VM-execution control is 0 or the logical processor was not using PAE paging at the time of the VM exit, the values saved are undefined.

28.4 SAVING MSRS

After processor state is saved to the guest-state area, values of MSRs may be stored into the VM-exit MSR-store area (see Section 25.7.2). Specifically each entry in that area (up to the number specified in the VM-exit MSR-store count) is processed in order by storing the value of the MSR indexed by bits 31:0 (as they would be read by RDMSR) into bits 127:64. Processing of an entry fails in either of the following cases:

1. A logical processor uses PAE paging if CR0.PG = 1, CR4.PAE = 1 and IA32_EFER.LMA = 0. See Section 4.4 in the Intel® 64 and IA-32 Architectures Software Developer’s Manual, Volume 3A. “Enable EPT” is a secondary processor-based VM-execution control. If bit 31 of the primary processor-based VM-execution controls is 0, VM exit functions as if the “enable EPT” VM-execution control were 0. See Section 25.6.2.

- The value of bits 31:8 is 000008H, meaning that the indexed MSR is one that allows access to an APIC register when the local APIC is in x2APIC mode.
- The value of bits 31:0 indicates an MSR that can be read only in system-management mode (SMM) and the VM exit will not end in SMM. (IA32_SMBASE is an MSR that can be read only in SMM.)
- The value of bits 31:0 indicates an MSR that cannot be saved on VM exits for model-specific reasons. A processor may prevent certain MSRs (based on the value of bits 31:0) from being stored on VM exits, even if they can normally be read by RDMSR. Such model-specific behavior is documented in Chapter 2, “Model-Specific Registers (MSRs),” in the Intel® 64 and IA-32 Architectures Software Developer’s Manual, Volume 4.
- Bits 63:32 of the entry are not all 0.
- An attempt to read the MSR indexed by bits 31:0 would cause a general-protection exception if executed via RDMSR with CPL = 0.

A VMX abort occurs if processing fails for any entry. See Section 28.7.

28.5 LOADING HOST STATE

Processor state is updated on VM exits in the following ways:

- Some state is loaded from or otherwise determined by the contents of the host-state area.
- Some state is determined by VM-exit controls.
- Some state is established in the same way on every VM exit.
- The page-directory pointers are loaded based on the values of certain control registers.

This loading may be performed in any order.

On processors that support Intel 64 architecture, the full values of each 64-bit field loaded (for example, the base address for GDTR) is loaded regardless of the mode of the logical processor before and after the VM exit.

The loading of host state is detailed in Section 28.5.1 to Section 28.5.5. These sections reference VMCS fields that correspond to processor state. Unless otherwise stated, these references are to fields in the host-state area.

A logical processor is in IA-32e mode after a VM exit only if the “host address-space size” VM-exit control is 1. If the logical processor was in IA-32e mode before the VM exit and this control is 0, a VMX abort occurs. See Section 28.7.

In addition to loading host state, VM exits clear address-range monitoring (Section 28.5.6).

After the state loading described in this section, VM exits may load MSRs from the VM-exit MSR-load area (see Section 28.6). This loading occurs only after the state loading described in this section.

28.5.1 Loading Host Control Registers, Debug Registers, MSRs

VM exits load new values for controls registers, debug registers, and some MSRs:

- CR0, CR3, and CR4 are loaded from the CR0 field, the CR3 field, and the CR4 field, respectively, with the following exceptions:
 - The following bits are not modified:
 - For CR0, ET, CD, NW; bits 63:32 (on processors that support Intel 64 architecture), 28:19, 17, and 15:6; and any bits that are fixed in VMX operation (see Section 24.8).¹
 - For CR3, bits 63:52 and bits in the range 51:32 beyond the processor’s physical-address width (they are cleared to 0).² (This item applies only to processors that support Intel 64 architecture.)

1. Bits 28:19, 17, and 15:6 of CR0 and CR0.ET are unchanged by executions of MOV to CR0. CR0.ET is always 1 and the other bits are always 0.

2. Software can determine a processor’s physical-address width by executing CPUID with 80000008H in EAX. The physical-address width is returned in bits 7:0 of EAX.

- For CR4, any bits that are fixed in VMX operation (see Section 24.8).
 - CR4.PAE is set to 1 if the “host address-space size” VM-exit control is 1.
 - CR4.PCIDE is set to 0 if the “host address-space size” VM-exit control is 0.
- DR7 is set to 400H.
- If the “clear UINV” VM-exit control is 1, VM exit clears UINV.
- The following MSRs are established as follows:
 - The IA32_DEBUGCTL MSR is cleared to 00000000_00000000H.
 - The IA32_SYSENTER_CS MSR is loaded from the IA32_SYSENTER_CS field. Since that field has only 32 bits, bits 63:32 of the MSR are cleared to 0.
 - The IA32_SYSENTER_ESP and IA32_SYSENTER_EIP MSRs are loaded from the IA32_SYSENTER_ESP and IA32_SYSENTER_EIP fields, respectively.

If the processor does not support the Intel 64 architecture, these fields have only 32 bits; bits 63:32 of the MSRs are cleared to 0.

If the processor supports the Intel 64 architecture with $N < 64$ linear-address bits, each of bits 63:N is set to the value of bit $N-1$.¹
 - The following steps are performed on processors that support Intel 64 architecture:
 - The MSRs FS.base and GS.base are loaded from the base-address fields for FS and GS, respectively (see Section 28.5.2).
 - The LMA and LME bits in the IA32_EFER MSR are each loaded with the setting of the “host address-space size” VM-exit control.
 - If the “load IA32_PERF_GLOBAL_CTRL” VM-exit control is 1, the IA32_PERF_GLOBAL_CTRL MSR is loaded from the IA32_PERF_GLOBAL_CTRL field. Bits that are reserved in that MSR are maintained with their reserved values.
 - If the “load IA32_PAT” VM-exit control is 1, the IA32_PAT MSR is loaded from the IA32_PAT field. Bits that are reserved in that MSR are maintained with their reserved values.
 - If the “load IA32_EFER” VM-exit control is 1, the IA32_EFER MSR is loaded from the IA32_EFER field. Bits that are reserved in that MSR are maintained with their reserved values.
 - If the “clear IA32_BNDCFGS” VM-exit control is 1, the IA32_BNDCFGS MSR is cleared to 00000000_00000000H; otherwise, it is not modified.
 - If the “clear IA32_RTIT_CTL” VM-exit control is 1, the IA32_RTIT_CTL MSR is cleared to 00000000_00000000H; otherwise, it is not modified.
 - If the “load CET” VM-exit control is 1, the IA32_S_CET and IA32_INTERRUPT_SSP_TABLE_ADDR MSRs are loaded from the IA32_S_CET and IA32_INTERRUPT_SSP_TABLE_ADDR fields, respectively.

If the processor does not support the Intel 64 architecture, these fields have only 32 bits; bits 63:32 of the MSRs are cleared to 0.

If the processor supports the Intel 64 architecture with $N < 64$ linear-address bits, each of bits 63:N is set to the value of bit $N-1$.
 - If the “load PKRS” VM-exit control is 1, the IA32_PKRS MSR is loaded from the IA32_PKRS field. Bits 63:32 of that MSR are maintained with zeroes.

With the exception of FS.base and GS.base, any of these MSRs is subsequently overwritten if it appears in the VM-exit MSR-load area. See Section 28.6.

1. Software can determine the number N by executing CPUID with 80000008H in EAX. The number of linear-address bits supported is returned in bits 15:8 of EAX.

28.5.2 Loading Host Segment and Descriptor-Table Registers

Each of the registers CS, SS, DS, ES, FS, GS, and TR is loaded as follows (see below for the treatment of LDTR):

- The selector is loaded from the selector field. The segment is unusable if its selector is loaded with zero. The checks specified in Section 27.2.3 limit the selector values that may be loaded. In particular, CS and TR are never loaded with zero and are thus never unusable. SS can be loaded with zero only on processors that support Intel 64 architecture and only if the VM exit is to 64-bit mode (64-bit mode allows use of segments marked unusable).
- The base address is set as follows:
 - CS. Cleared to zero.
 - SS, DS, and ES. Undefined if the segment is unusable; otherwise, cleared to zero.
 - FS and GS. Undefined (but, on processors that support Intel 64 architecture, canonical) if the segment is unusable and the VM exit is not to 64-bit mode; otherwise, loaded from the base-address field.
 If the processor supports the Intel 64 architecture and the processor supports $N < 64$ linear-address bits, each of bits 63:N is set to the value of bit $N-1$.¹ The values loaded for base addresses for FS and GS are also manifest in the FS.base and GS.base MSRs.
 - TR. Loaded from the host-state area. If the processor supports the Intel 64 architecture and the processor supports $N < 64$ linear-address bits, each of bits 63:N is set to the value of bit $N-1$.
- The segment limit is set as follows:
 - CS. Set to FFFFFFFFH (corresponding to a descriptor limit of FFFFFFFH and a G-bit setting of 1).
 - SS, DS, ES, FS, and GS. Undefined if the segment is unusable; otherwise, set to FFFFFFFFH.
 - TR. Set to 00000067H.
- The type field and S bit are set as follows:
 - CS. Type set to 11 and S set to 1 (execute/read, accessed, non-conforming code segment).
 - SS, DS, ES, FS, and GS. Undefined if the segment is unusable; otherwise, type set to 3 and S set to 1 (read/write, accessed, expand-up data segment).
 - TR. Type set to 11 and S set to 0 (busy 32-bit task-state segment).
- The DPL is set as follows:
 - CS, SS, and TR. Set to 0. The current privilege level (CPL) will be 0 after the VM exit completes.
 - DS, ES, FS, and GS. Undefined if the segment is unusable; otherwise, set to 0.
- The P bit is set as follows:
 - CS, TR. Set to 1.
 - SS, DS, ES, FS, and GS. Undefined if the segment is unusable; otherwise, set to 1.
- On processors that support Intel 64 architecture, CS.L is loaded with the setting of the “host address-space size” VM-exit control. Because the value of this control is also loaded into IA32_EFER.LMA (see Section 28.5.1), no VM exit is ever to compatibility mode (which requires IA32_EFER.LMA = 1 and CS.L = 0).
- D/B.
 - CS. Loaded with the inverse of the setting of the “host address-space size” VM-exit control. For example, if that control is 0, indicating a 32-bit guest, CS.D/B is set to 1.
 - SS. Set to 1.
 - DS, ES, FS, and GS. Undefined if the segment is unusable; otherwise, set to 1.
 - TR. Set to 0.
- G.

1. Software can determine the number N by executing CPUID with 80000008H in EAX. The number of linear-address bits supported is returned in bits 15:8 of EAX.

- CS. Set to 1.
- SS, DS, ES, FS, and GS. Undefined if the segment is unusable; otherwise, set to 1.
- TR. Set to 0.

The host-state area does not contain a selector field for LDTR. LDTR is established as follows on all VM exits: the selector is cleared to 0000H, the segment is marked unusable and is otherwise undefined (although the base address is always canonical).

The base addresses for GDTR and IDTR are loaded from the GDTR base-address field and the IDTR base-address field, respectively. If the processor supports the Intel 64 architecture and the processor supports $N < 64$ linear-address bits, each of bits 63:N of each base address is set to the value of bit N-1 of that base address. The GDTR and IDTR limits are each set to FFFFH.

28.5.3 Loading Host RIP, RSP, RFLAGS, and SSP

RIP and RSP are loaded from the RIP field and the RSP field, respectively. RFLAGS is cleared, except bit 1, which is always set.

If the “load CET” VM-exit control is 1, SSP (shadow-stack pointer) is loaded from the SSP field.

28.5.4 Checking and Loading Host Page-Directory-Pointer-Table Entries

If $CR0.PG = 1$, $CR4.PAE = 1$, and $IA32_EFER.LMA = 0$, the logical processor uses **PAE paging**. See Section 4.4 of the Intel® 64 and IA-32 Architectures Software Developer’s Manual, Volume 3A.¹ When in PAE paging is in use, the physical address in CR3 references a table of **page-directory-pointer-table entries** (PDPTEs). A MOV to CR3 when PAE paging is in use checks the validity of the PDPTes and, if they are valid, loads them into the processor (into internal, non-architectural registers).

A VM exit is to a VMM that uses PAE paging if (1) bit 5 (corresponding to CR4.PAE) is set in the CR4 field in the host-state area of the VMCS; and (2) the “host address-space size” VM-exit control is 0. Such a VM exit may check the validity of the PDPTes referenced by the CR3 field in the host-state area of the VMCS. Such a VM exit must check their validity if either (1) PAE paging was not in use before the VM exit; or (2) the value of CR3 is changing as a result of the VM exit. A VM exit to a VMM that does not use PAE paging must not check the validity of the PDPTes.

A VM exit that checks the validity of the PDPTes uses the same checks that are used when CR3 is loaded with MOV to CR3 when PAE paging is in use. If MOV to CR3 would cause a general-protection exception due to the PDPTes that would be loaded (e.g., because a reserved bit is set), a VMX abort occurs (see Section 28.7). If a VM exit to a VMM that uses PAE does not cause a VMX abort, the PDPTes are loaded into the processor as would MOV to CR3, using the value of CR3 being load by the VM exit.

28.5.5 Updating Non-Register State

VM exits affect the non-register state of a logical processor as follows:

- A logical processor is always in the active state after a VM exit.
- Event blocking is affected as follows:
 - There is no blocking by STI or by MOV SS after a VM exit.
 - VM exits caused directly by non-maskable interrupts (NMIs) cause blocking by NMI (see Table 25-3). Other VM exits do not affect blocking by NMI. (See Section 28.1 for the case in which an NMI causes a VM exit indirectly.)
- There are no pending debug exceptions after a VM exit.

1. On processors that support Intel 64 architecture, the physical-address extension may support more than 36 physical-address bits. Software can determine a processor’s physical-address width by executing CPUID with 80000008H in EAX. The physical-address width is returned in bits 7:0 of EAX.

Section 29.4 describes how the VMX architecture controls how a logical processor manages information in the TLBs and paging-structure caches. The following items detail how VM exits invalidate cached mappings:

- If the “enable VPID” VM-execution control is 0, the logical processor invalidates linear mappings and combined mappings associated with VPID 0000H (for all PCIDs); combined mappings for VPID 0000H are invalidated for all EPTRTA values (EPTRTA is the value of bits 51:12 of EPTP).
- VM exits are not required to invalidate any guest-physical mappings, nor are they required to invalidate any linear mappings or combined mappings if the “enable VPID” VM-execution control is 1.

28.5.6 Clearing Address-Range Monitoring

The Intel 64 and IA-32 architectures allow software to monitor a specified address range using the MONITOR and MWAIT instructions. See Section 9.10.4 in the Intel® 64 and IA-32 Architectures Software Developer’s Manual, Volume 3A. VM exits clear any address-range monitoring that may be in effect.

28.6 LOADING MSRS

VM exits may load MSRs from the VM-exit MSR-load area (see Section 25.7.2). Specifically each entry in that area (up to the number specified in the VM-exit MSR-load count) is processed in order by loading the MSR indexed by bits 31:0 with the contents of bits 127:64 as they would be written by WRMSR.

Processing of an entry fails in any of the following cases:

- The value of bits 31:0 is either C0000100H (the IA32_FS_BASE MSR) or C0000101H (the IA32_GS_BASE MSR).
- The value of bits 31:8 is 000008H, meaning that the indexed MSR is one that allows access to an APIC register when the local APIC is in x2APIC mode.
- The value of bits 31:0 indicates an MSR that can be written only in system-management mode (SMM) and the VM exit will not end in SMM. (IA32_SMM_MONITOR_CTL is an MSR that can be written only in SMM.)
- The value of bits 31:0 indicates an MSR that cannot be loaded on VM exits for model-specific reasons. A processor may prevent loading of certain MSRs even if they can normally be written by WRMSR. Such model-specific behavior is documented in Chapter 2, “Model-Specific Registers (MSRs),” in the Intel® 64 and IA-32 Architectures Software Developer’s Manual, Volume 4.
- Bits 63:32 are not all 0.
- An attempt to write bits 127:64 to the MSR indexed by bits 31:0 of the entry would cause a general-protection exception if executed via WRMSR with CPL = 0.¹

If processing fails for any entry, a VMX abort occurs. See Section 28.7.

If any MSR is being loaded in such a way that would architecturally require a TLB flush, the TLBs are updated so that, after VM exit, the logical processor does not use any translations that were cached before the transition.

28.7 VMX ABORTS

A problem encountered during a VM exit leads to a **VMX abort**. A VMX abort takes a logical processor into a shut-down state as described below.

A VMX abort does not modify the VMCS data in the VMCS region of any active VMCS. The contents of these data are thus suspect after the VMX abort.

On a VMX abort, a logical processor saves a nonzero 32-bit VMX-abort indicator field at byte offset 4 in the VMCS region of the VMCS whose misconfiguration caused the failure (see Section 25.2). The following values are used:

1. Note the following about processors that support Intel 64 architecture. If CRO.PG = 1, WRMSR to the IA32_EFER MSR causes a general-protection exception if it would modify the LME bit. Since CRO.PG is always 1 in VMX operation, the IA32_EFER MSR should not be included in the VM-exit MSR-load area for the purpose of modifying the LME bit.

1. There was a failure in saving guest MSRs (see Section 28.4).
2. Host checking of the page-directory-pointer-table entries (PDPTes) failed (see Section 28.5.4).
3. The current VMCS has been corrupted (through writes to the corresponding VMCS region) in such a way that the logical processor cannot complete the VM exit properly.
4. There was a failure on loading host MSRs (see Section 28.6).
5. There was a machine-check event during VM exit (see Section 28.8).
6. The logical processor was in IA-32e mode before the VM exit and the “host address-space size” VM-exit control was 0 (see Section 28.5).

Some of these causes correspond to failures during the loading of state from the host-state area. Because the loading of such state may be done in any order (see Section 28.5) a VM exit that might lead to a VMX abort for multiple reasons (for example, the current VMCS may be corrupt and the host PDPTes might not be properly configured). In such cases, the VMX-abort indicator could correspond to any one of those reasons.

A logical processor never reads the VMX-abort indicator in a VMCS region and writes it only with one of the non-zero values mentioned above. The VMX-abort indicator allows software on one logical processor to diagnose the VMX-abort on another. For this reason, it is recommended that software running in VMX root operation zero the VMX-abort indicator in the VMCS region of any VMCS that it uses.

After saving the VMX-abort indicator, operation of a logical processor experiencing a VMX abort depends on whether the logical processor is in SMX operation:¹

- If the logical processor is in SMX operation, an Intel[®] TXT shutdown condition occurs. The error code used is 000DH, indicating “VMX abort.” See the Intel[®] Trusted Execution Technology Measured Launched Environment Programming Guide.
- If the logical processor is outside SMX operation, it issues a special bus cycle (to notify the chipset) and enters the **VMX-abort shutdown state**. RESET is the only event that wakes a logical processor from the VMX-abort shutdown state. The following events do not affect a logical processor in this state: machine-check events; INIT signals; external interrupts; non-maskable interrupts (NMIs); start-up IPIs (SIPIs); and system-management interrupts (SMIs).

28.8 MACHINE-CHECK EVENTS DURING VM EXIT

If a machine-check event occurs during VM exit, one of the following occurs:

- The machine-check event is handled as if it occurred before the VM exit:
 - If CR4.MCE = 0, operation of the logical processor depends on whether the logical processor is in SMX operation:¹
 - If the logical processor is in SMX operation, an Intel[®] TXT shutdown condition occurs. The error code used is 000CH, indicating “unrecoverable machine-check condition.”
 - If the logical processor is outside SMX operation, it goes to the shutdown state.
 - If CR4.MCE = 1, a machine-check exception (#MC) is generated:
 - If bit 18 (#MC) of the exception bitmap is 0, the exception is delivered through the guest IDT.
 - If bit 18 of the exception bitmap is 1, the exception causes a VM exit.
- The machine-check event is handled after VM exit completes:
 - If the VM exit ends with CR4.MCE = 0, operation of the logical processor depends on whether the logical processor is in SMX operation:

1. A logical processor is in SMX operation if GETSEC[SEXIT] has not been executed since the last execution of GETSEC[SENDER]. A logical processor is outside SMX operation if GETSEC[SENDER] has not been executed or if GETSEC[SEXIT] was executed after the last execution of GETSEC[SENDER]. See Chapter 7, “Safer Mode Extensions Reference,” in Intel[®] 64 and IA-32 Architectures Software Developer’s Manual, Volume 2D.

- If the logical processor is in SMX operation, an Intel[®] TXT shutdown condition occurs with error code 000CH (unrecoverable machine-check condition).
- If the logical processor is outside SMX operation, it goes to the shutdown state.
- If the VM exit ends with CR4.MCE = 1, a machine-check exception (#MC) is delivered through the host IDT.
- A VMX abort is generated (see Section 28.7). The logical processor blocks events as done normally in VMX abort. The VMX abort indicator is 5, for “machine-check event during VM exit.”

The first option is not used if the machine-check event occurs after any host state has been loaded. The second option is used only if VM entry is able to load all host state.

28.9 USER-INTERRUPT RECOGNITION AFTER VM EXIT

A VM exit results in recognition of a pending user interrupt if it completes with CR4.UINTR = IA32_EFER.LMA = 1 and with UIRR ≠ 0; otherwise, no pending user interrupt is recognized.

CHAPTER 29

VMX SUPPORT FOR ADDRESS TRANSLATION

The architecture for VMX operation includes two features that support address translation: virtual-processor identifiers (VPIDs) and the extended page-table mechanism (EPT). VPIDs are a mechanism for managing translations of linear addresses. EPT defines a layer of address translation that augments the translation of linear addresses.

Section 29.1 details the architecture of VPIDs. Section 29.3 provides the details of EPT. Section 29.4 explains how a logical processor may cache information from the paging structures, how it may use that cached information, and how software can managed the cached information.

29.1 VIRTUAL PROCESSOR IDENTIFIERS (VPIDS)

The original architecture for VMX operation required VMX transitions to flush the TLBs and paging-structure caches. This ensured that translations cached for the old linear-address space would not be used after the transition.

Virtual-processor identifiers (**VPIDs**) introduce to VMX operation a facility by which a logical processor may cache information for multiple linear-address spaces. When VPIDs are used, VMX transitions may retain cached information and the logical processor switches to a different linear-address space.

Section 29.4 details the mechanisms by which a logical processor manages information cached for multiple address spaces. A logical processor may tag some cached information with a 16-bit VPID. This section specifies how the current VPID is determined at any point in time:

- The current VPID is 0000H in the following situations:
 - Outside VMX operation. (This includes operation in system-management mode under the default treatment of SMIs and SMM with VMX operation; see Section 32.14.)
 - In VMX root operation.
 - In VMX non-root operation when the “enable VPID” VM-execution control is 0.
- If the logical processor is in VMX non-root operation and the “enable VPID” VM-execution control is 1, the current VPID is the value of the VPID VM-execution control field in the VMCS. (VM entry ensures that this value is never 0000H; see Section 27.2.1.1.)

VPIDs and PCIDs (see Section 4.10.1) can be used concurrently. When this is done, the processor associates cached information with both a VPID and a PCID. Such information is used only if the current VPID and PCID **both** match those associated with the cached information.

29.2 HYPERVISOR-MANAGED LINEAR-ADDRESS TRANSLATION (HLAT)

Hypervisor-managed linear-address translation (HLAT) is a feature that changes the way in which linear addresses are translated in VMX non-root operation. Instead of ordinary paging, translation uses a modified process called **HLAT paging**.

HLAT paging is used only if the “enable HLAT” VM-execution control is 1. HLAT paging is used only for the paging modes 4-level paging and 5-level paging. Because HLAT paging is a modification of ordinary paging, details of the feature are given in Section 4.5, which describes the operation of 4-level paging and 5-level paging.

29.3 THE EXTENDED PAGE TABLE MECHANISM (EPT)

The extended page-table mechanism (**EPT**) is a feature that can be used to support the virtualization of physical memory. When EPT is in use, certain addresses that would normally be treated as physical addresses (and used to access memory) are instead treated as **guest-physical addresses**. Guest-physical addresses are translated by traversing a set of **EPT paging structures** to produce physical addresses that are used to access memory.

- Section 29.3.1 gives an overview of EPT.
- Section 29.3.2 describes operation of EPT-based address translation.
- Section 29.3.3 discusses VM exits that may be caused by EPT.
- Section 29.3.7 describes interactions between EPT and memory typing.

29.3.1 EPT Overview

EPT is used when the “enable EPT” VM-execution control is 1.¹ It translates the guest-physical addresses used in VMX non-root operation and those used by VM entry for event injection.

The translation from guest-physical addresses to physical addresses is determined by a set of **EPT paging structures**. The EPT paging structures are similar to those used to translate linear addresses while the processor is in IA-32e mode. Section 29.3.2 gives the details of the EPT paging structures.

If $CR0.PG = 1$, linear addresses are translated through paging structures referenced through control register CR3.² While the “enable EPT” VM-execution control is 1, these are called **guest paging structures**. There are no guest paging structures if $CR0.PG = 0$.³

When the “enable EPT” VM-execution control is 1, the identity of **guest-physical addresses** depends on the value of $CR0.PG$:

- If $CR0.PG = 0$, each linear address is treated as a guest-physical address.
- If $CR0.PG = 1$, guest-physical addresses are those derived from the contents of control register CR3 and the guest paging structures. (This includes the values of the PDPTes, which logical processors store in internal, non-architectural registers.) The latter includes (in page-table entries and in other paging-structure entries for which bit 7—PS—is 1) the addresses to which linear addresses are translated by the guest paging structures.

If $CR0.PG = 1$, the translation of a linear address to a physical address requires multiple translations of guest-physical addresses using EPT. Assume, for example, that $CR4.PAE = CR4.PSE = 0$. The translation of a 32-bit linear address then operates as follows:

- Bits 31:22 of the linear address select an entry in the guest page directory located at the guest-physical address in CR3. The guest-physical address of the guest page-directory entry (PDE) is translated through EPT to determine the guest PDE’s physical address.
- Bits 21:12 of the linear address select an entry in the guest page table located at the guest-physical address in the guest PDE. The guest-physical address of the guest page-table entry (PTE) is translated through EPT to determine the guest PTE’s physical address.
- Bits 11:0 of the linear address is the offset in the page frame located at the guest-physical address in the guest PTE. The guest-physical address determined by this offset is translated through EPT to determine the physical address to which the original linear address translates.

In addition to translating a guest-physical address to a physical address, EPT specifies the privileges that software is allowed when accessing the address. Attempts at disallowed accesses are called **EPT violations** and cause VM exits. See Section 29.3.3.

A processor uses EPT to translate guest-physical addresses only when those addresses are used to access memory. This principle implies the following:

- The MOV to CR3 instruction loads CR3 with a guest-physical address. Whether that address is translated through EPT depends on whether PAE paging is being used.⁴

1. “Enable EPT” is a secondary processor-based VM-execution control. If bit 31 of the primary processor-based VM-execution controls is 0, the logical processor operates as if the “enable EPT” VM-execution control were 0. See Section 25.6.2.
2. If HLAT paging is enabled, the processor uses the HLATP VMCS field instead of CR3. See Section 4.5.1. For simplicity, the remainder of this section refers only to CR3.
3. If the capability MSR IA32_VMX_CR0_FIXED0 reports that $CR0.PG$ must be 1 in VMX operation, $CR0.PG$ can be 0 in VMX non-root operation only if the “unrestricted guest” VM-execution control and bit 31 of the primary processor-based VM-execution controls are both 1.
4. A logical processor uses PAE paging if $CR0.PG = 1$, $CR4.PAE = 1$ and $IA32_EFER.LMA = 0$. See Section 4.4 in the Intel® 64 and IA-32 Architectures Software Developer’s Manual, Volume 3A.

- If PAE paging is not being used, the instruction does not use that address to access memory and does **not** cause it to be translated through EPT. (If CR0.PG = 1, the address will be translated through EPT on the next memory accessing using a linear address.)
- If PAE paging is being used, the instruction loads the four (4) page-directory-pointer-table entries (PDPTEs) from that address and it **does** cause the address to be translated through EPT.
- Section 4.4.1 identifies executions of MOV to CR0 and MOV to CR4 that load the PDPTEs from the guest-physical address in CR3. Such executions cause that address to be translated through EPT.
- The PDPTEs contain guest-physical addresses. The instructions that load the PDPTEs (see above) do not use those addresses to access memory and do **not** cause them to be translated through EPT. The address in a PDPTE will be translated through EPT on the next memory accessing using a linear address that uses that PDPTE.

29.3.2 EPT Translation Mechanism

The EPT translation mechanism can be configured in either of two modes: **4-level EPT** or **5-level EPT**. 4-level EPT accesses at most 4 EPT paging-structure entries (an EPT page-walk length of 4) to translate a guest-physical address and uses only bits 47:0 of each guest-physical address. In contrast, 5-level EPT may access up to 5 EPT paging-structure entries (an EPT page-walk length of 5) and uses guest-physical address bits 56:0.¹

The EPT page-walk length is configured using the extended-page-table pointer (EPTP), a VM-execution control field (see Table 25-9 in Section 25.6.11). Specifically, bits 5:3 contain a value one less than EPT page-walk length. Thus, a value of 3 configures 4-level EPT, while a value of 4 configures 5-level EPT.²

The remainder of this section describes the translation process used by 4-level EPT and 5-level EPT. Because the processes used by the two EPT modes are similar, they are described together in the following items (with any differences identified):

- With 5-level EPT, 4-KByte naturally aligned EPT PML5 table is located at the physical address specified in bits 51:12 of the EPTP. An EPT PML5 table comprises 512 64-bit entries (EPT PML5Es). An EPT PML5E is selected using the physical address defined as follows:
 - Bits 63:52 are all 0.
 - Bits 51:12 are from the EPTP.
 - Bits 11:3 are bits 56:48 of the guest-physical address.³
 - Bits 2:0 are all 0.

Because an EPT PML5E is identified using bits 56:48 of the guest-physical address, it controls access to a 256-TByte region of the guest-physical-address space. The format of an EPT PML5E is given in Table 29-1.
- With 4-level EPT, bits 51:48 of the guest-physical address must all be zero; otherwise, an EPT violation occurs (see Section 29.3.3).
- A 4-KByte naturally aligned EPT PML4 table is located at the physical address specified in the EPTP (for 4-level EPT) or in the EPT PML5E (for 5-level EPT). An EPT PML4 table comprises 512 64-bit entries (EPT PML4Es). An EPT PML4E is selected using the physical address defined as follows:
 - Bits 63:52 are all 0.
 - Bits 51:12 are from the EPTP (for 4-level EPT) or from bits 51:12 of the EPT PML4E (for 5-level EPT).
 - Bits 11:3 are bits 47:39 of the guest-physical address.
 - Bits 2:0 are all 0.

1. Physical addresses and guest-physical addresses are architecturally limited to 52 bits (e.g., by paging), so in practice bits 56:52 are zero.

2. Software should read the VMX capability MSR IA32_VMX_EPT_VPID_CAP (see Appendix A.10) to determine what EPT page-walk lengths are supported.

3. Bits 56:52 of each guest-physical address are necessarily zero because guest-physical addresses are architecturally limited to 52 bits.

Table 29-1. Format of an EPT PML5 Entry (PML5E) that References an EPT PML4 Table

Bit Position(s)	Contents
0	Read access; indicates whether reads are allowed from the 256-TByte region controlled by this entry.
1	Write access; indicates whether writes are allowed to the 256-TByte region controlled by this entry.
2	If the “mode-based execute control for EPT” VM-execution control is 0, execute access; indicates whether instruction fetches are allowed from the 256-TByte region controlled by this entry. If that control is 1, execute access for supervisor-mode linear addresses; indicates whether instruction fetches are allowed from supervisor-mode linear addresses in the 256-TByte region controlled by this entry.
7:3	Reserved (must be 0).
8	If bit 6 of EPTP is 1, accessed flag for EPT; indicates whether software has accessed the 256-TByte region controlled by this entry (see Section 29.3.5). Ignored if bit 6 of EPTP is 0.
9	Ignored.
10	Execute access for user-mode linear addresses. If the “mode-based execute control for EPT” VM-execution control is 1, indicates whether instruction fetches are allowed from user-mode linear addresses in the 256-TByte region controlled by this entry. If that control is 0, this bit is ignored.
11	Ignored.
(N-1):12	Physical address of 4-KByte aligned EPT PML4 table referenced by this entry. ¹
51:N	Reserved (must be 0).
63:52	Ignored.

NOTES:

1. N is the physical-address width supported by the processor. Software can determine a processor’s physical-address width by executing CPUID with 80000008H in EAX. The physical-address width is returned in bits 7:0 of EAX.

Because an EPT PML4E is identified using bits 47:39 of the guest-physical address, it controls access to a 512-GByte region of the guest-physical-address space. The format of an EPT PML4E is given in Table 29-2.

- A 4-KByte naturally aligned EPT page-directory-pointer table is located at the physical address specified in bits 51:12 of the EPT PML4E. An EPT page-directory-pointer table comprises 512 64-bit entries (EPT PDPTes). An EPT PDPTE is selected using the physical address defined as follows:
 - Bits 63:52 are all 0.
 - Bits 51:12 are from the EPT PML4E.
 - Bits 11:3 are bits 38:30 of the guest-physical address.
 - Bits 2:0 are all 0.

Because an EPT PDPTE is identified using bits 47:30 of the guest-physical address, it controls access to a 1-GByte region of the guest-physical-address space. Use of the EPT PDPTE depends on the value of bit 7 in that entry:¹

- If bit 7 of the EPT PDPTE is 1, the EPT PDPTE maps a 1-GByte page. The final physical address is computed as follows:
 - Bits 63:52 are all 0.
 - Bits 51:30 are from the EPT PDPTE.
 - Bits 29:0 are from the original guest-physical address.

1. Not all processors allow bit 7 of an EPT PDPTE to be set to 1. Software should read the VMX capability MSR IA32_VMX_EPT_VPID_CAP (see Appendix A.10) to determine whether this is allowed.

Table 29-2. Format of an EPT PML4 Entry (PML4E) that References an EPT Page-Directory-Pointer Table

Bit Position(s)	Contents
0	Read access; indicates whether reads are allowed from the 512-GByte region controlled by this entry.
1	Write access; indicates whether writes are allowed to the 512-GByte region controlled by this entry.
2	If the “mode-based execute control for EPT” VM-execution control is 0, execute access; indicates whether instruction fetches are allowed from the 512-GByte region controlled by this entry. If that control is 1, execute access for supervisor-mode linear addresses; indicates whether instruction fetches are allowed from supervisor-mode linear addresses in the 512-GByte region controlled by this entry.
7:3	Reserved (must be 0).
8	If bit 6 of EPTP is 1, accessed flag for EPT; indicates whether software has accessed the 512-GByte region controlled by this entry (see Section 29.3.5). Ignored if bit 6 of EPTP is 0.
9	Ignored.
10	Execute access for user-mode linear addresses. If the “mode-based execute control for EPT” VM-execution control is 1, indicates whether instruction fetches are allowed from user-mode linear addresses in the 512-GByte region controlled by this entry. If that control is 0, this bit is ignored.
11	Ignored.
(N-1):12	Physical address of 4-KByte aligned EPT page-directory-pointer table referenced by this entry. ¹
51:N	Reserved (must be 0).
63:52	Ignored.

NOTES:

1. N is the physical-address width supported by the processor.

The format of an EPT PDPTE that maps a 1-GByte page is given in Table 29-3.

- If bit 7 of the EPT PDPTE is 0, a 4-KByte naturally aligned EPT page directory is located at the physical address specified in bits 51:12 of the EPT PDPTE. The format of an EPT PDPTE that references an EPT page directory is given in Table 29-4.

Table 29-3. Format of an EPT Page-Directory-Pointer-Table Entry (PDPTE) that Maps a 1-GByte Page

Bit Position(s)	Contents
0	Read access; indicates whether reads are allowed from the 1-GByte page referenced by this entry.
1	Write access; indicates whether writes are allowed to the 1-GByte page referenced by this entry.
2	If the “mode-based execute control for EPT” VM-execution control is 0, execute access; indicates whether instruction fetches are allowed from the 1-GByte page controlled by this entry. If that control is 1, execute access for supervisor-mode linear addresses; indicates whether instruction fetches are allowed from supervisor-mode linear addresses in the 1-GByte page controlled by this entry.
5:3	EPT memory type for this 1-GByte page (see Section 29.3.7).
6	Ignore PAT memory type for this 1-GByte page (see Section 29.3.7).
7	Must be 1 (otherwise, this entry references an EPT page directory).
8	If bit 6 of EPTP is 1, accessed flag for EPT; indicates whether software has accessed the 1-GByte page referenced by this entry (see Section 29.3.5). Ignored if bit 6 of EPTP is 0.
9	If bit 6 of EPTP is 1, dirty flag for EPT; indicates whether software has written to the 1-GByte page referenced by this entry (see Section 29.3.5). Ignored if bit 6 of EPTP is 0.
10	Execute access for user-mode linear addresses. If the “mode-based execute control for EPT” VM-execution control is 1, indicates whether instruction fetches are allowed from user-mode linear addresses in the 1-GByte page controlled by this entry. If that control is 0, this bit is ignored.
11	Ignored.
29:12	Reserved (must be 0).
(N-1):30	Physical address of the 1-GByte page referenced by this entry. ¹
51:N	Reserved (must be 0).
56:52	Ignored.
57	Verify guest paging. If the “guest-paging verification” VM-execution control is 1, indicates limits on the guest paging structures used to access the 1-GByte page controlled by this entry (see Section 29.3.3.2). If that control is 0, this bit is ignored.
58	Paging-write access. If the “EPT paging-write control” VM-execution control is 1, indicates that guest paging may update the 1-GByte page controlled by this entry (see Section 29.3.3.2). If that control is 0, this bit is ignored.
59	Ignored.
60	Supervisor shadow stack. If bit 7 of EPTP is 1, indicates whether supervisor shadow stack accesses are allowed to guest-physical addresses in the 1-GByte page mapped by this entry (see Section 29.3.3.2). Ignored if bit 7 of EPTP is 0.
62:61	Ignored.
63	Suppress #VE. If the “EPT-violation #VE” VM-execution control is 1, EPT violations caused by accesses to this page are convertible to virtualization exceptions only if this bit is 0 (see Section 26.5.7.1). If “EPT-violation #VE” VM-execution control is 0, this bit is ignored.

NOTES:

1. N is the physical-address width supported by the processor.

Table 29-4. Format of an EPT Page-Directory-Pointer-Table Entry (PDPTE) that References an EPT Page Directory

Bit Position(s)	Contents
0	Read access; indicates whether reads are allowed from the 1-GByte region controlled by this entry.
1	Write access; indicates whether writes are allowed to the 1-GByte region controlled by this entry.
2	If the “mode-based execute control for EPT” VM-execution control is 0, execute access; indicates whether instruction fetches are allowed from the 1-GByte region controlled by this entry. If that control is 1, execute access for supervisor-mode linear addresses; indicates whether instruction fetches are allowed from supervisor-mode linear addresses in the 1-GByte region controlled by this entry.
7:3	Reserved (must be 0).
8	If bit 6 of EPTP is 1, accessed flag for EPT; indicates whether software has accessed the 1-GByte region controlled by this entry (see Section 29.3.5). Ignored if bit 6 of EPTP is 0.
9	Ignored.
10	Execute access for user-mode linear addresses. If the “mode-based execute control for EPT” VM-execution control is 1, indicates whether instruction fetches are allowed from user-mode linear addresses in the 1-GByte region controlled by this entry. If that control is 0, this bit is ignored.
11	Ignored.
(N-1):12	Physical address of 4-KByte aligned EPT page directory referenced by this entry. ¹
51:N	Reserved (must be 0).
63:52	Ignored.

NOTES:

1. N is the physical-address width supported by the processor.

An EPT page-directory comprises 512 64-bit entries (PDEs). An EPT PDE is selected using the physical address defined as follows:

- Bits 63:52 are all 0.
- Bits 51:12 are from the EPT PDPTE.
- Bits 11:3 are bits 29:21 of the guest-physical address.
- Bits 2:0 are all 0.

Because an EPT PDE is identified using bits 47:21 of the guest-physical address, it controls access to a 2-MByte region of the guest-physical-address space. Use of the EPT PDE depends on the value of bit 7 in that entry:

- If bit 7 of the EPT PDE is 1, the EPT PDE maps a 2-MByte page. The final physical address is computed as follows:
 - Bits 63:52 are all 0.
 - Bits 51:21 are from the EPT PDE.
 - Bits 20:0 are from the original guest-physical address.

The format of an EPT PDE that maps a 2-MByte page is given in Table 29-5.

- If bit 7 of the EPT PDE is 0, a 4-KByte naturally aligned EPT page table is located at the physical address specified in bits 51:12 of the EPT PDE. The format of an EPT PDE that references an EPT page table is given in Table 29-6.

An EPT page table comprises 512 64-bit entries (PTEs). An EPT PTE is selected using a physical address defined as follows:

- Bits 63:52 are all 0.

Table 29-5. Format of an EPT Page-Directory Entry (PDE) that Maps a 2-MByte Page

Bit Position(s)	Contents
0	Read access; indicates whether reads are allowed from the 2-MByte page referenced by this entry.
1	Write access; indicates whether writes are allowed to the 2-MByte page referenced by this entry.
2	If the “mode-based execute control for EPT” VM-execution control is 0, execute access; indicates whether instruction fetches are allowed from the 2-MByte page controlled by this entry. If that control is 1, execute access for supervisor-mode linear addresses; indicates whether instruction fetches are allowed from supervisor-mode linear addresses in the 2-MByte page controlled by this entry.
5:3	EPT memory type for this 2-MByte page (see Section 29.3.7).
6	Ignore PAT memory type for this 2-MByte page (see Section 29.3.7).
7	Must be 1 (otherwise, this entry references an EPT page table).
8	If bit 6 of EPTP is 1, accessed flag for EPT; indicates whether software has accessed the 2-MByte page referenced by this entry (see Section 29.3.5). Ignored if bit 6 of EPTP is 0.
9	If bit 6 of EPTP is 1, dirty flag for EPT; indicates whether software has written to the 2-MByte page referenced by this entry (see Section 29.3.5). Ignored if bit 6 of EPTP is 0.
10	Execute access for user-mode linear addresses. If the “mode-based execute control for EPT” VM-execution control is 1, indicates whether instruction fetches are allowed from user-mode linear addresses in the 2-MByte page controlled by this entry. If that control is 0, this bit is ignored.
11	Ignored.
20:12	Reserved (must be 0).
(N-1):21	Physical address of the 2-MByte page referenced by this entry. ¹
51:N	Reserved (must be 0).
56:52	Ignored.
57	Verify guest paging. If the “guest-paging verification” VM-execution control is 1, indicates limits on the guest paging structures used to access the 2-MByte page controlled by this entry (see Section 29.3.3.2). If that control is 0, this bit is ignored.
58	Paging-write access. If the “EPT paging-write control” VM-execution control is 1, indicates that guest paging may update the 2-MByte page controlled by this entry (see Section 29.3.3.2). If that control is 0, this bit is ignored.
59	Ignored.
60	Supervisor shadow stack. If bit 7 of EPTP is 1, indicates whether supervisor shadow stack accesses are allowed to guest-physical addresses in the 2-MByte page mapped by this entry (see Section 29.3.3.2). Ignored if bit 7 of EPTP is 0.
62:61	Ignored.
63	Suppress #VE. If the “EPT-violation #VE” VM-execution control is 1, EPT violations caused by accesses to this page are convertible to virtualization exceptions only if this bit is 0 (see Section 26.5.7.1). If “EPT-violation #VE” VM-execution control is 0, this bit is ignored.

NOTES:

1. N is the physical-address width supported by the processor.

- Bits 51:12 are from the EPT PDE.

- Bits 11:3 are bits 20:12 of the guest-physical address.
- Bits 2:0 are all 0.
- Because an EPT PTE is identified using bits 47:12 of the guest-physical address, every EPT PTE maps a 4-KByte page. The final physical address is computed as follows:
 - Bits 63:52 are all 0.
 - Bits 51:12 are from the EPT PTE.
 - Bits 11:0 are from the original guest-physical address.

The format of an EPT PTE is given in Table 29-7.

An EPT paging-structure entry is **present** if any of bits 2:0 is 1; otherwise, the entry is **not present**. The processor ignores bits 62:3 and uses the entry neither to reference another EPT paging-structure entry nor to produce a physical address. A reference using a guest-physical address whose translation encounters an EPT paging-structure that is not present causes an EPT violation (see Section 29.3.3.2). (If the “EPT-violation #VE” VM-execution control is 1, the EPT violation is convertible to a virtualization exception only if bit 63 is 0; see Section 26.5.7.1. If the “EPT-violation #VE” VM-execution control is 0, this bit is ignored.)

Table 29-6. Format of an EPT Page-Directory Entry (PDE) that References an EPT Page Table

Bit Position(s)	Contents
0	Read access; indicates whether reads are allowed from the 2-MByte region controlled by this entry.
1	Write access; indicates whether writes are allowed to the 2-MByte region controlled by this entry.
2	If the “mode-based execute control for EPT” VM-execution control is 0, execute access; indicates whether instruction fetches are allowed from the 2-MByte region controlled by this entry. If that control is 1, execute access for supervisor-mode linear addresses; indicates whether instruction fetches are allowed from supervisor-mode linear addresses in the 2-MByte region controlled by this entry.
6:3	Reserved (must be 0).
7	Must be 0 (otherwise, this entry maps a 2-MByte page).
8	If bit 6 of EPTP is 1, accessed flag for EPT; indicates whether software has accessed the 2-MByte region controlled by this entry (see Section 29.3.5). Ignored if bit 6 of EPTP is 0.
9	Ignored.
10	Execute access for user-mode linear addresses. If the “mode-based execute control for EPT” VM-execution control is 1, indicates whether instruction fetches are allowed from user-mode linear addresses in the 2-MByte region controlled by this entry. If that control is 0, this bit is ignored.
11	Ignored.
(N-1):12	Physical address of 4-KByte aligned EPT page table referenced by this entry. ¹
51:N	Reserved (must be 0).
63:52	Ignored.

NOTES:

1. N is the physical-address width supported by the processor.

NOTE

If the “mode-based execute control for EPT” VM-execution control is 1, an EPT paging-structure entry is present if any of bits 2:0 **or bit 10** is 1. If bits 2:0 are all 0 but bit 10 is 1, the entry is used normally to reference another EPT paging-structure entry or to produce a physical address.

The discussion above describes how the EPT paging structures reference each other and how the logical processor traverses those structures when translating a guest-physical address. It does not cover all details of the translation process. Additional details are provided as follows:

- Situations in which the translation process may lead to VM exits (sometimes before the process completes) are described in Section 29.3.3.
- Interactions between the EPT translation mechanism and memory typing are described in Section 29.3.7.

Figure 29-1 gives a summary of the formats of the EPTP and the EPT paging-structure entries. For the EPT paging structure entries, it identifies separately the format of entries that map pages, those that reference other EPT paging structures, and those that do neither because they are not present; bits 2:0 and bit 7 are highlighted because they determine how a paging-structure entry is used. (Figure 29-1 does not comprehend the fact that, if the “mode-based execute control for EPT” VM-execution control is 1, an entry is present if any of bits 2:0 or bit 10 is 1.)

29.3.3 EPT-Induced VM Exits

Accesses using guest-physical addresses may cause VM exits due to EPT misconfigurations, EPT violations, and page-modification log-full events. An **EPT misconfiguration** occurs when, in the course of translating a guest-physical address, the logical processor encounters an EPT paging-structure entry that contains an unsupported value (see Section 29.3.3.1). An **EPT violation** occurs when there is no EPT misconfiguration but the EPT paging-structure entries disallow an access using the guest-physical address (see Section 29.3.3.2). A **page-modification log-full event** occurs when the logical processor determines a need to create a page-modification log entry and the current log is full (see Section 29.3.6).

These events occur only due to an attempt to access memory with a guest-physical address. Loading CR3 with a guest-physical address with the MOV to CR3 instruction can cause neither an EPT configuration nor an EPT violation until that address is used to access a paging structure.¹

If the “EPT-violation #VE” VM-execution control is 1, certain EPT violations may cause virtualization exceptions instead of VM exits. See Section 26.5.7.1.

29.3.3.1 EPT Misconfigurations

An EPT misconfiguration occurs if translation of a guest-physical address encounters an EPT paging-structure entry that meets any of the following conditions:

- Bit 0 of the entry is clear (indicating that data reads are not allowed) and any of the following hold:
 - Bit 1 is set (indicating that data writes are allowed).
 - The processor does not support execute-only translations and either of the following hold:
 - Bit 2 is set (indicating that instruction fetches are allowed).²
 - The “mode-based execute control for EPT” VM-execution control is 1 and bit 10 is set (indicating that instruction fetches are allowed from user-mode linear addresses).

Software should read the VMX capability MSR IA32_VMX_EPT_VPID_CAP to determine whether execute-only translations are supported (see Appendix A.10).

- The “EPT paging-write control” VM-execution control is 1, the entry maps a page, and bit 58 is set (indicating that paging writes are allowed).
- The entry is present (see Section 29.3.2) and of the following holds:

1. If the logical processor is using PAE paging—because CR0.PG = CR4.PAE = 1 and IA32_EFER.LMA = 0—the MOV to CR3 instruction loads the PDPTs from memory using the guest-physical address being loaded into CR3. In this case, therefore, the MOV to CR3 instruction may cause an EPT misconfiguration, an EPT violation, or a page-modification log-full event.

2. If the “mode-based execute control for EPT” VM-execution control is 1, setting bit 2 indicates that instruction fetches are allowed from supervisor-mode linear addresses.

Table 29-7. Format of an EPT Page-Table Entry that Maps a 4-KByte Page

Bit Position(s)	Contents
0	Read access; indicates whether reads are allowed from the 4-KByte page referenced by this entry.
1	Write access; indicates whether writes are allowed to the 4-KByte page referenced by this entry.
2	If the “mode-based execute control for EPT” VM-execution control is 0, execute access; indicates whether instruction fetches are allowed from the 4-KByte page controlled by this entry. If that control is 1, execute access for supervisor-mode linear addresses; indicates whether instruction fetches are allowed from supervisor-mode linear addresses in the 4-KByte page controlled by this entry.
5:3	EPT memory type for this 4-KByte page (see Section 29.3.7).
6	Ignore PAT memory type for this 4-KByte page (see Section 29.3.7).
7	Ignored.
8	If bit 6 of EPTP is 1, accessed flag for EPT; indicates whether software has accessed the 4-KByte page referenced by this entry (see Section 29.3.5). Ignored if bit 6 of EPTP is 0.
9	If bit 6 of EPTP is 1, dirty flag for EPT; indicates whether software has written to the 4-KByte page referenced by this entry (see Section 29.3.5). Ignored if bit 6 of EPTP is 0.
10	Execute access for user-mode linear addresses. If the “mode-based execute control for EPT” VM-execution control is 1, indicates whether instruction fetches are allowed from user-mode linear addresses in the 4-KByte page controlled by this entry. If that control is 0, this bit is ignored.
11	Ignored.
(N-1):12	Physical address of the 4-KByte page referenced by this entry. ¹
51:N	Reserved (must be 0).
56:52	Ignored.
57	Verify guest paging. If the “guest-paging verification” VM-execution control is 1, indicates limits on the guest paging structures used to access the 4-KByte page controlled by this entry (see Section 29.3.3.2). If that control is 0, this bit is ignored.
58	Paging-write access. If the “EPT paging-write control” VM-execution control is 1, indicates that guest paging may update the 4-KByte page controlled by this entry (see Section 29.3.3.2). If that control is 0, this bit is ignored.
59	Ignored.
60	Supervisor shadow stack. If bit 7 of EPTP is 1, indicates whether supervisor shadow stack accesses are allowed to guest-physical addresses in the 4-KByte page mapped by this entry (see Section 29.3.3.2). Ignored if bit 7 of EPTP is 0.
61	Sub-page write permissions. If the “sub-page write permissions for EPT” VM-execution control is 1, writes to individual 128-byte regions of the 4-KByte page referenced by this entry may be allowed even if the page would normally not be writable (see Section 29.3.4). If “sub-page write permissions for EPT” VM-execution control is 0, this bit is ignored.
62	Ignored.
63	Suppress #VE. If the “EPT-violation #VE” VM-execution control is 1, EPT violations caused by accesses to this page are convertible to virtualization exceptions only if this bit is 0 (see Section 26.5.7.1). If “EPT-violation #VE” VM-execution control is 0, this bit is ignored.

NOTES:

1. N is the physical-address width supported by the processor.

- A reserved bit is set. This includes the setting of a bit in the range 51:12 that is beyond the logical processor's physical-address width.¹ See Section 29.3.2 for details of which bits are reserved in which EPT paging-structure entries.
- The entry is the last one used to translate a guest physical address (either an EPT PDE with bit 7 set to 1 or an EPT PTE) and the value of bits 5:3 (EPT memory type) is 2, 3, or 7 (these values are reserved).

EPT misconfigurations result when an EPT paging-structure entry is configured with settings reserved for future functionality. Software developers should be aware that such settings may be used in the future and that an EPT paging-structure entry that causes an EPT misconfiguration on one processor might not do so in the future.

29.3.3.2 EPT Violations

An EPT violation may occur during an access using a guest-physical address whose translation does not cause an EPT misconfiguration. An EPT violation occurs in any of the following situations:

- Translation of the guest-physical address encounters an EPT paging-structure entry that is not present (see Section 29.3.2).
- The access is a data read and, for any byte to be read, bit 0 (read access) was clear in any of the EPT paging-structure entries used to translate the guest-physical address of the byte. Reads by the logical processor of guest paging structures to translate a linear address are considered to be data reads.

1. Software can determine a processor's physical-address width by executing CPUID with 80000008H in EAX. The physical-address width is returned in bits 7:0 of EAX.

6. If the “mode-based execute control for EPT” VM-execution control is 1, an EPT paging-structure entry is present if any of bits 2:0 or bit 10 is 1. This table does not comprehend that fact.
7. Suppress #VE. If the “EPT-violation #VE” VM-execution control is 0, this bit is ignored.
8. Supervisor shadow-stack page. If bit 7 of the EPTP is 0, this bit is ignored.
9. Paging-write access. If the “EPT paging-write control” VM-execution control is 0, this bit is ignored.
10. Verify guest paging. If the “guest-paging verification” VM-execution control is 0, this bit is ignored.
11. Sub-page write permissions. If the “sub-page write permissions for EPT” VM-execution control is 0, this bit is ignored.

- The access is a data write and, for any byte to be written, bit 1 (write access) was clear in any of the EPT paging-structure entries used to translate the guest-physical address of the byte. Writes by the logical processor to guest paging structures to update accessed and dirty flags are considered to be data writes. If bit 6 of the EPT pointer (EPTP) is 1 (enabling accessed and dirty flags for EPT), processor accesses to guest paging-structure entries are treated as writes with regard to EPT violations. Thus, if bit 1 is clear in any of the EPT paging-structure entries used to translate the guest-physical address of a guest paging-structure entry, an attempt to use that entry to translate a linear address causes an EPT violation.

(This does not apply to loads of the PDPTTE registers by the MOV to CR instruction for PAE paging; see Section 4.4.1. Those loads of guest PDPTEs are treated as reads and do not cause EPT violations due to a guest-physical address not being writable.)

Processor writes to guest paging structures to update accessed and dirty flags are called **paging writes**. (When accessed and dirty flags for EPT are enabled all processor accesses to guest paging structures are considered paging writes.) If the “EPT paging-write control” VM-execution control is 1, clearing the write-access bit in the EPT paging-structure entry that maps a page does not prevent a paging write if bit 58 (paging-write access) in that entry is 1. (EPT paging-structure entries that reference other EPT paging structures do not use bit 58, and it remains the case that they must set the write-access bit for paging writes to be allowed.)

If the “sub-page write permissions for EPT” VM-execution control is 1, data writes to a guest-physical address that would cause an EPT violation (as indicated above) do not do so in certain situations. If the guest-physical address is mapped using a 4-KByte page and bit 61 (sub-page write permissions) of the EPT PTE used to map the page is 1, writes to certain 128-byte sub-pages may be allowed. See Section 29.3.4 for details.

- The access is an instruction fetch and the EPT paging structures prevent execute access to any of the bytes being fetched. Whether this occurs depends upon the setting of the “mode-based execute control for EPT” VM-execution control:
 - If the control is 0, an instruction fetch from a byte is prevented if bit 2 (execute access) was clear in any of the EPT paging-structure entries used to translate the guest-physical address of the byte.
 - If the control is 1, an instruction fetch from a byte is prevented in either of the following cases:
 - Paging maps the linear address of the byte as a supervisor-mode address and bit 2 (execute access for supervisor-mode linear addresses) was clear in any of the EPT paging-structure entries used to translate the guest-physical address of the byte.

Paging maps a linear address as a supervisor-mode address if the U/S flag (bit 2) is 0 in at least one of the paging-structure entries controlling the translation of the linear address.
 - Paging maps the linear address of the byte as a user-mode address and bit 10 (execute access for user-mode linear addresses) was clear in any of the EPT paging-structure entries used to translate the guest-physical address of the byte.

Paging maps a linear address as a user-mode address if the U/S flag is 1 in all of the paging-structure entries controlling the translation of the linear address. If paging is disabled (CR0.PG = 0), every linear address is a user-mode address.
- If supervisor shadow-stack control is enabled (by setting bit 7 of EPTP), the access is a supervisor shadow-stack access, and the EPT paging-structure entries used to translate the guest-physical address of the access disallow supervisor shadow-stack accesses. Such an access is disallowed if any of the following hold:
 - Bit 0 (read access) is clear in any EPT paging-structure entry used to translate the guest-physical address of the access.

- Bit 1 (write access) is clear in any EPT paging-structure entry that references an EPT paging structure in the translation of the guest-physical address. (Clearing bit 1 in the EPT paging-structure entry that maps the page of the guest-physical address does not disallow shadow-stack reads and writes.)
- Bit 60 (supervisor-shadow stack access) is clear in the EPT paging-structure entry that maps the page of the guest-physical address.

Supervisor shadow-stack control and the supervisor-shadow stack access bits in EPT paging-structure entries do not affect other accesses (including user shadow-stack accesses).

- If the “guest-paging verification” and “EPT paging-write control” VM-execution controls are both 1, **guest-paging verification** is performed for certain accesses related to translation of a linear address.

Specifically, guest-paging verification may apply to an access using a guest-physical address to the guest paging-structure entry that maps a page for the linear address (see Chapter 4, “Paging”). It applies if bit 57 (verify guest paging) is set in the EPT paging-structure entry that maps a page for that guest-physical address.

When guest-paging verification occurs, there is an EPT violation if bit 58 (paging-write access) is clear in the EPT paging-structure entry that was used to map a page for the guest-physical address of any guest paging-structure entry that was used during translation of the original linear address.¹

See Section 29.3.3.3 for details regarding the prioritization of such EPT violations relative to any page faults that may occur due to the original reference to the linear address being translated.

29.3.3.3 Prioritization of EPT Misconfigurations and EPT Violations

The translation of a linear address to a physical address requires one or more translations of guest-physical addresses using EPT (see Section 29.3.1). This section specifies the relative priority of EPT-induced VM exits with respect to each other and to other events that may be encountered when accessing memory using a linear address.

For an access to a guest-physical address, determination of whether an EPT misconfiguration or an EPT violation occurs is based on an iterative process:²

1. An EPT paging-structure entry is read (initially, this is an EPT PML5 entry or an EPT PML4 entry):
 - a. If the entry is not present (see Section 29.3.2), an EPT violation occurs.
 - b. If the entry is present but its contents are not configured properly (see Section 29.3.3.1), an EPT misconfiguration occurs.
 - c. If the entry is present and its contents are configured properly, operation depends on whether the entry references another EPT paging structure (or if instead it is an EPT PDPTTE or EPT PDE with bit 7 set to 1, or an EPT PTE):
 - i) If the entry does reference another EPT paging structure, an entry from that structure is accessed; step 1 is executed for that other entry.
 - ii) Otherwise, the entry is used to produce the ultimate physical address (the translation of the original guest-physical address); step 2 is executed.
2. Once the ultimate physical address is determined, the privileges determined by the EPT paging-structure entries are evaluated:
 - a. If the access to the guest-physical address is not allowed by these privileges (see Section 29.3.3.2), an EPT violation occurs.
 - b. If the access to the guest-physical address is allowed by these privileges, memory is accessed using the ultimate physical address.

If CR0.PG = 1, the translation of a linear address is also an iterative process, with the processor first accessing an entry in the guest paging structure referenced by the guest-physical address in CR3,³ then accessing an entry in

-
1. When there is a restart of HLAT paging (see Section 4.5), the guest paging-structure entries used by HLAT paging (prior to the restart) are not relevant to guest-paging verification.
 2. This is a simplification of the more detailed description given in Section 29.3.2.
 3. If PAE paging is in use, the processor instead uses the guest-physical address in the appropriate PDPTTE register. If HLAT paging is enabled, the processor instead uses the HLATP VMCS field. For simplicity, the remainder of this section refers only to CR3.

another guest paging structure referenced by the guest-physical address in the first guest paging-structure entry, etc. Each guest-physical address is itself translated using EPT and may cause an EPT-induced VM exit. The following items detail how page faults and EPT-induced VM exits are recognized during this iterative process:

1. An attempt is made to access a guest paging-structure entry with a guest-physical address (initially, the address in CR3).
 - a. If the access fails because of an EPT misconfiguration or an EPT violation (see above), an EPT-induced VM exit occurs.
 - b. If the access does not cause an EPT-induced VM exit, the translation continues. If guest-paging verification is enabled (see Section 29.3.3.2), the processor notes whether the EPT paging-structure entry used to map a page for the guest-physical address set bit 58 (paging write). Then, bit 0 (the present flag) of the guest paging-structure entry is consulted:
 - i) If the present flag is 0 or any reserved bit is set, a page fault occurs.
 - ii) If the present flag is 1, no reserved bit is set, operation depends on whether the entry references another guest paging structure (whether it is a guest PDE with PS = 1 or a guest PTE):
 - If the entry does reference another guest paging structure, an entry from that structure is accessed; step 1 is executed for that other entry.
 - Otherwise, the entry is used to produce the ultimate guest-physical address (the translation of the original linear address); step 2 is executed.
2. Once the ultimate guest-physical address is determined, the privileges determined by the guest paging-structure entries are evaluated:
 - a. If the access to the linear address is not allowed by these privileges (e.g., it was a write to a read-only page), a page fault occurs.
 - b. If the access to the linear address is allowed by these privileges, an attempt is made to access memory at the ultimate guest-physical address:
 - i) If the access fails because of an EPT misconfiguration or an EPT violation (see above), an EPT-induced VM exit occurs. It is at this point that guest-paging verification occurs (if enabled), using the paging-write bits that were noted at occurrences of step 1b above (see Section 29.3.3.2 for details of guest-paging verification).
 - ii) If the access does not cause an EPT-induced VM exit, memory is accessed using the ultimate physical address (the translation, using EPT, of the ultimate guest-physical address).

If CR0.PG = 0, a linear address is treated as a guest-physical address and is translated using EPT (see above). This process, if it completes without an EPT violation or EPT misconfiguration, produces a physical address and determines the privileges allowed by the EPT paging-structure entries. If these privileges do not allow the access to the physical address (see Section 29.3.3.2), an EPT violation occurs. Otherwise, memory is accessed using the physical address.

29.3.4 Sub-Page Write Permissions

Section 29.3.3.2 explained how EPT enforces the access rights for guest-physical addresses using EPT violations. Since these access rights are determined using the EPT paging-structure entries that are used to translate a guest-physical address, their granularity is limited to that which is used to map pages (1-GByte, 2-MByte, or 4-KByte).

The **sub-page write-permission** feature allows the control of write accesses to guest-physical addresses to be controlled at finer granularity. Sub-page write permissions allow write accesses to be controlled at the granularity of naturally aligned 128-byte **sub-pages**. Specifically, the feature allows writes to selected sub-pages of 4-KByte page that would otherwise not be writable.

Sub-page write permissions are enabled setting the “sub-page write permissions for EPT” VM-execution control to 1. The remainder of this section describes changes to processor operation with this control setting.

Section 29.3.4.1 identifies the data accesses that are eligible for sub-page write permissions. Section 29.3.4.2 explains how the processor determines whether to allow such an access.

29.3.4.1 Write Accesses That Are Eligible for Sub-Page Write Permissions

A guest-physical address is eligible for sub-page write permissions if writes to it would be disallowed following Section 29.3.3.2: bit 1 (write access) is clear in any of the EPT paging-structure entries used to translate the guest-physical address. Guest-physical addresses to which writes would be disallowed for other reasons (e.g., the translation encounters an EPT paging-structure entry that is not present) are not eligible for sub-page write permissions.

In addition, a guest-physical address is eligible for sub-page write permissions only if it is mapped using a 4-KByte page and bit 61 (sub-page write permissions) of the EPT PTE used to map the page is 1. (Guest-physical addresses mapped with larger pages are not eligible for sub-page write permissions.)

For some memory accesses, the processor ignores bit 61 in an EPT PTE used to map a 4-KByte page and does not apply sub-page write permissions to the access. (In such a case, the access causes an EPT violation when indicated by the conditions given in Section 29.3.3.2.) Sub-page write permissions never apply to the following accesses:

- A write access performed within a transactional region.
- A write access by an enclave to an address within the enclave's ELRANGE. (Sub-page write permissions may apply to write accesses by an enclaves to addresses outside its ELRANGE.)
- A write access to the enclave page cache (EPC) by an Intel SGX instruction.
- A write access to a guest paging structure to update an accessed or dirty flag.
- Processor accesses to guest paging-structure entries when accessed and dirty flags for EPT are enabled (such accesses are treated as writes with regard to EPT violations).

There are additional accesses to which sub-page write permissions might not be applied (behavior is model-specific). The following items enumerate examples:

- A write access that crosses two 4-KByte pages. In this case, sub-page permissions may be applied to neither or to only one of the pages. (There is no write to either page unless the write is allowed to both pages.)
- A write access by an instruction that performs multiple write accesses (sub-page write permissions are intended principally for basic instructions such as AND, MOV, OR, TEST, XCHG, and XOR).

If a guest-physical address is eligible for sub-page write permissions, the processor determines whether to allow write to the address using the process described in Section 29.3.4.2.

If a guest-physical address is eligible for sub-page write permissions and that address translates to an address on the APIC-access page (see Section 30.4), the processor may treat a write access to the address as if the “virtualize APIC accesses” VM-execution control were 0. For that reason, it is recommended that software not configure any guest-physical address that translates to an address on the APIC-access page to be eligible for sub-page write permissions.

29.3.4.2 Determining an Access's Sub-Page Write Permission

Sub-page write permissions control write accesses individually to each of the 32 128-byte sub-pages of a 4-KByte page. Bits 11:7 of guest-physical address identify the sub-page.

For each guest-physical address eligible for sub-page write permissions, there is a 64-bit **sub-page permission vector (SPP vector)**. All addresses on a 4-KByte page use the same SPP vector. If an address's sub-page number (bits 11:7 of the address) is *S*, writes to address are allowed if and only if bit 2*S* of the sub-page permission is set to 1. (The bits at odd positions in a SPP vector are not used and must be zero.)

Each page's SPP vector is located in memory. For a write to a guest-physical address eligible for sub-page write permissions, the processor uses the following process to locate the address's SPP vector:

1. The SPPTP (sub-page-permission-table pointer) VM-execution control field contains the physical address of the 4-KByte root SPP table (SSPL4 table). Bits 47:39 of the guest-physical address identify a 64-bit entry in that table, called an SPPL4E.
2. A 4-KByte SPPL3 table is located at the physical address in the selected SPPL4E. Bits 38:30 of the guest-physical address identify a 64-bit entry in that table, called an SPPL3E.
3. A 4-KByte SPPL2 table is located at the physical address in the selected SPPL3E. Bits 29:21 of the guest-physical address identify a 64-bit entry in that table, called an SPPL2E.

4. A 4-KByte SPP-vector table (SSPL1 table) is located at the physical address in the selected SPPL2E. Bits 20:12 of the guest-physical address identify the 64-bit SPP vector for the address. As noted earlier, bit 2S of the sub-page permission vector determines whether the address may be written, where S is the value of address bits 11:7.

(The memory type used to access these tables is reported in bits 53:50 of the IA32_VMX_BASIC MSR. See Appendix A.1.)

A write access to multiple 128-byte sub-pages on a single 4-KByte page is allowed only if the indicated bit in the page's SPP vector for each of those sub-pages is set to 1. The following items apply to cases in which an access writes to two 4-KByte pages:

- If a write to either page would be disallowed according to Section 29.3.3.2, the access might be disallowed even if the guest-physical address of that page is eligible for sub-page write permissions. (This behavior is model-specific.)
- The access is allowed only if, for each page, either (1) a write to the page would be allowed following Section 29.3.3.2; or (2) both (a) the guest-physical address of that page is eligible for sub-page write permissions; and (b) the page's sub-page vector allows the write (as described above).

Bit 0 of each entry (SPPL4E, SPPL3E, or SPPL2E) is the entry's **valid** bit. If the process above accesses an entry in which this bit is 0, the process stops and the logical processor incurs an **SPP miss**.

In each entry (SPPL4E, SPPL3E, or SPPL2E), bits 11:1 are reserved, as are bits 63:N, where N is the processor's physical-address width. If the process above accesses an entry in which the valid bit is 1 and in which some reserved bit is set, the process stops and the logical processor incurs an **SPP misconfiguration**. Bits in an SPP vector in odd positions are also reserved; an SPP misconfiguration occurs also any of those bits are set in the final SPP vector.

SPP misses and SPP misconfigurations are called **SPP-related events** and cause VM exits.

29.3.5 Accessed and Dirty Flags for EPT

The Intel 64 architecture supports **accessed and dirty flags** in ordinary paging-structure entries (see Section 4.8). Some processors also support corresponding flags in EPT paging-structure entries. Software should read the VMX capability MSR IA32_VMX_EPT_VPID_CAP (see Appendix A.10) to determine whether the processor supports this feature.

Software can enable accessed and dirty flags for EPT using bit 6 of the extended-page-table pointer (EPTP), a VM-execution control field (see Table 25-9 in Section 25.6.11). If this bit is 1, the processor will set the accessed and dirty flags for EPT as described below. In addition, setting this flag causes processor accesses to guest paging-structure entries to be treated as writes (see below and Section 29.3.3.2).

For any EPT paging-structure entry that is used during guest-physical-address translation, bit 8 is the accessed flag. For a EPT paging-structure entry that maps a page (as opposed to referencing another EPT paging structure), bit 9 is the dirty flag.

Whenever the processor uses an EPT paging-structure entry as part of guest-physical-address translation, it sets the accessed flag in that entry (if it is not already set).

Whenever there is a write to a guest-physical address, the processor sets the dirty flag (if it is not already set) in the EPT paging-structure entry that identifies the final physical address for the guest-physical address (either an EPT PTE or an EPT paging-structure entry in which bit 7 is 1).

When accessed and dirty flags for EPT are enabled, processor accesses to guest paging-structure entries are treated as writes (see Section 29.3.3.2). Thus, such an access will cause the processor to set the dirty flag in the EPT paging-structure entry that identifies the final physical address of the guest paging-structure entry.

(This does not apply to loads of the PDPT registers for PAE paging by the MOV to CR instruction; see Section 4.4.1. Those loads of guest PDPTs are treated as reads and do not cause the processor to set the dirty flag in any EPT paging-structure entry.)

These flags are "sticky," meaning that, once set, the processor does not clear them; only software can clear them.

A processor may cache information from the EPT paging-structure entries in TLBs and paging-structure caches (see Section 29.4). This fact implies that, if software changes an accessed flag or a dirty flag from 1 to 0, the processor might not set the corresponding bit in memory on a subsequent access using an affected guest-physical address.

29.3.6 Page-Modification Logging

When accessed and dirty flags for EPT are enabled, software can track writes to guest-physical addresses using a feature called **page-modification logging**.

Software can enable page-modification logging by setting the “enable PML” VM-execution control (see Table 25-7 in Section 25.6.2). When this control is 1, the processor adds entries to the **page-modification log** as described below. The page-modification log is a 4-KByte region of memory located at the physical address in the PML address VM-execution control field. The page-modification log consists of 512 64-bit entries; the PML index VM-execution control field indicates the next entry to use.

Before allowing a guest-physical access, the processor may determine that it first needs to set an accessed or dirty flag for EPT (see Section 29.3.5). When this happens, the processor examines the PML index. If the PML index is not in the range 0–511, there is a **page-modification log-full event** and a VM exit occurs. In this case, the accessed or dirty flag is not set, and the guest-physical access that triggered the event does not occur.

If instead the PML index is in the range 0–511, the processor proceeds to update accessed or dirty flags for EPT as described in Section 29.3.5. If the processor updated a dirty flag for EPT (changing it from 0 to 1), it then operates as follows:

1. The guest-physical address of the access is written to the page-modification log. Specifically, the guest-physical address is written to physical address determined by adding 8 times the PML index to the PML address. Bits 11:0 of the value written are always 0 (the guest-physical address written is thus 4-KByte aligned).
2. The PML index is decremented by 1 (this may cause the value to transition from 0 to FFFFH).

Because the processor decrements the PML index with each log entry, the value may transition from 0 to FFFFH. At that point, no further logging will occur, as the processor will determine that the PML index is not in the range 0–511 and will generate a page-modification log-full event (see above).

29.3.7 EPT and Memory Typing

This section specifies how a logical processor determines the memory type use for a memory access while EPT is in use. (See Chapter 12, “Memory Cache Control,” of the Intel® 64 and IA-32 Architectures Software Developer’s Manual, Volume 3A, for details of memory typing in the Intel 64 architecture.) Section 29.3.7.1 explains how the memory type is determined for accesses to the EPT paging structures. Section 29.3.7.2 explains how the memory type is determined for an access using a guest-physical address that is translated using EPT.

29.3.7.1 Memory Type Used for Accessing EPT Paging Structures

This section explains how the memory type is determined for accesses to the EPT paging structures. The determination is based first on the value of bit 30 (cache disable—CD) in control register CR0:

- If CR0.CD = 0, the memory type used for any such reference is the EPT paging-structure memory type, which is specified in bits 2:0 of the extended-page-table pointer (EPTP), a VM-execution control field (see Section 25.6.11). A value of 0 indicates the uncacheable type (UC), while a value of 6 indicates the write-back type (WB). Other values are reserved.
- If CR0.CD = 1, the memory type used for any such reference is uncacheable (UC).

The MTRRs have no effect on the memory type used for an access to an EPT paging structure.

29.3.7.2 Memory Type Used for Translated Guest-Physical Addresses

The **effective memory type** of a memory access using a guest-physical address (an access that is translated using EPT) is the memory type that is used to access memory. The effective memory type is based on the value of

bit 30 (cache disable—CD) in control register CR0; the **last** EPT paging-structure entry used to translate the guest-physical address (either an EPT PDE with bit 7 set to 1 or an EPT PTE); and the PAT memory type (see below):

- The **PAT memory type** depends on the value of CR0.PG:
 - If CR0.PG = 0, the PAT memory type is WB (writeback).¹
 - If CR0.PG = 1, the PAT memory type is the memory type selected from the IA32_PAT MSR as specified in Section 12.12.3, “Selecting a Memory Type from the PAT.”²
- The **EPT memory type** is specified in bits 5:3 of the last EPT paging-structure entry: 0 = UC; 1 = WC; 4 = WT; 5 = WP; and 6 = WB. Other values are reserved and cause EPT misconfigurations (see Section 29.3.3).
- If CR0.CD = 0, the effective memory type depends upon the value of bit 6 of the last EPT paging-structure entry:
 - If the value is 0, the effective memory type is the combination of the EPT memory type and the PAT memory type specified in Table 12-7 in Section 12.5.2.2, using the EPT memory type in place of the MTRR memory type.
 - If the value is 1, the memory type used for the access is the EPT memory type. The PAT memory type is ignored.
- If CR0.CD = 1, the effective memory type is UC.

The MTRRs have no effect on the memory type used for an access to a guest-physical address.

29.4 CACHING TRANSLATION INFORMATION

Processors supporting Intel® 64 and IA-32 architectures may accelerate the address-translation process by caching on the processor data from the structures in memory that control that process. Such caching is discussed in Section 4.10, “Caching Translation Information,” in the Intel® 64 and IA-32 Architectures Software Developer’s Manual, Volume 3A. The current section describes how this caching interacts with the VMX architecture.

The VPID and EPT features of the architecture for VMX operation augment this caching architecture. EPT defines the guest-physical address space and defines translations to that address space (from the linear-address space) and from that address space (to the physical-address space). Both features control the ways in which a logical processor may create and use information cached from the paging structures.

Section 29.4.1 describes the different kinds of information that may be cached. Section 29.4.2 specifies when such information may be cached and how it may be used. Section 29.4.3 details how software can invalidate cached information.

29.4.1 Information That May Be Cached

Section 4.10, “Caching Translation Information,” in the Intel® 64 and IA-32 Architectures Software Developer’s Manual, Volume 3A, identifies two kinds of translation-related information that may be cached by a logical processor: **translations**, which are mappings from linear page numbers to physical page frames, and **paging-structure caches**, which map the upper bits of a linear page number to information from the paging-structure entries used to translate linear addresses matching those upper bits.

The same kinds of information may be cached when VPIDs and EPT are in use. A logical processor may cache and use such information based on its function. Information with different functionality is identified as follows:

1. If the capability MSR IA32_VMX_CR0_FIXED0 reports that CR0.PG must be 1 in VMX operation, CR0.PG can be 0 in VMX non-root operation only if the “unrestricted guest” VM-execution control and bit 31 of the primary processor-based VM-execution controls are both 1.
2. Table 12-11 in Section 12.12.3, “Selecting a Memory Type from the PAT,” illustrates how the PAT memory type is selected based on the values of the PAT, PCD, and PWT bits in a page-table entry (or page-directory entry with PS = 1). For accesses to a guest paging-structure entry X, the PAT memory type is selected from the table by using a value of 0 for the PAT bit with the values of PCD and PWT from the paging-structure entry Y that references X (or from CR3 if X is in the root paging structure). With PAE paging, the PAT memory type for accesses to the PDPTes is WB.

- **Linear mappings.**¹ There are two kinds:
 - Linear translations. Each of these is a mapping from a linear page number to the physical page frame to which it translates, along with information about access privileges and memory typing.
 - Linear paging-structure-cache entries. Each of these is a mapping from the upper portion of a linear address to the physical address of the paging structure used to translate the corresponding region of the linear-address space, along with information about access privileges. For example, bits 47:39 of a linear address would map to the address of the relevant page-directory-pointer table.

Linear mappings do not contain information from any EPT paging structure.

- **Guest-physical mappings.**² There are two kinds:
 - Guest-physical translations. Each of these is a mapping from a guest-physical page number to the physical page frame to which it translates, along with information about access privileges and memory typing.
 - Guest-physical paging-structure-cache entries. Each of these is a mapping from the upper portion of a guest-physical address to the physical address of the EPT paging structure used to translate the corresponding region of the guest-physical address space, along with information about access privileges.

The information in guest-physical mappings about access privileges and memory typing is derived from EPT paging structures.

- **Combined mappings.**³ There are two kinds:
 - Combined translations. Each of these is a mapping from a linear page number to the physical page frame to which it translates, along with information about access privileges and memory typing.
 - Combined paging-structure-cache entries. Each of these is a mapping from the upper portion of a linear address to the physical address of the paging structure used to translate the corresponding region of the linear-address space, along with information about access privileges.

The information in combined mappings about access privileges and memory typing is derived from both guest paging structures and EPT paging structures.

Guest-physical mappings and combined mappings may also include SPP vectors and information about the data structures used to locate SPP vectors (see Section 29.3.4.2).

29.4.2 Creating and Using Cached Translation Information

The following items detail the creation of the mappings described in the previous section:⁴

- The following items describe the creation of mappings while EPT is not in use (including execution outside VMX non-root operation):
 - Linear mappings may be created. They are derived from the paging structures referenced (directly or indirectly) by the current value of CR3 and are associated with the current VPID and the current PCID.
 - No linear mappings are created with information derived from paging-structure entries that are not present (bit 0 is 0) or that set reserved bits. For example, if a PTE is not present, no linear mapping are created for any linear page number whose translation would use that PTE.
 - No guest-physical or combined mappings are created while EPT is not in use.
- The following items describe the creation of mappings while EPT is in use:
 - Guest-physical mappings may be created. They are derived from the EPT paging structures referenced (directly or indirectly) by bits 51:12 of the current EPTP. These 40 bits contain the address of the EPT root

1. Earlier versions of this manual used the term “VPID-tagged” to identify linear mappings.
 2. Earlier versions of this manual used the term “EPTP-tagged” to identify guest-physical mappings.
 3. Earlier versions of this manual used the term “dual-tagged” to identify combined mappings.
 4. This section associated cached information with the current VPID and PCID. If PCIDs are not supported or are not being used (e.g., because CR4.PCIDE = 0), all the information is implicitly associated with PCID 000H; see Section 4.10.1, “Process-Context Identifiers (PCIDs),” in the Intel® 64 and IA-32 Architectures Software Developer’s Manual, Volume 3A.

table (a EPT PML4 table with 4-level EPT or a EPT PML5 table with 5-level EPT); the notation **EPTRTA** refers to those 40 bits. Newly created guest-physical mappings are associated with the current EPTRTA.

- Combined mappings may be created. They are derived from the EPT paging structures referenced (directly or indirectly) by the current EPTRTA. If CR0.PG = 1, they are also derived from the paging structures referenced (directly or indirectly) by the current value of CR3. They are associated with the current VPID, the current PCID, and the current EPTRTA.¹ No combined paging-structure-cache entries are created if CR0.PG = 0.²
- No guest-physical mappings or combined mappings are created with information derived from EPT paging-structure entries that are not present (see Section 29.3.2) or that are misconfigured (see Section 29.3.3.1).
- No combined mappings are created with information derived from guest paging-structure entries that are not present or that set reserved bits.
- No linear mappings are created while EPT is in use.

The following items detail the use of the various mappings:

- If EPT is not in use (e.g., when outside VMX non-root operation), a logical processor may use cached mappings as follows:
 - For accesses using linear addresses, it may use linear mappings associated with the current VPID and the current PCID. It may also use global TLB entries (linear mappings) associated with the current VPID and any PCID.
 - No guest-physical or combined mappings are used while EPT is not in use.
- If EPT is in use, a logical processor may use cached mappings as follows:
 - For accesses using linear addresses, it may use combined mappings associated with the current VPID, the current PCID, and the current EPTRTA. It may also use global TLB entries (combined mappings) associated with the current VPID, the current EPTRTA, and any PCID.
 - For accesses using guest-physical addresses, it may use guest-physical mappings associated with the current EPTRTA.
 - No linear mappings are used while EPT is in use.

29.4.3 Invalidating Cached Translation Information

Software modifications of paging structures (including EPT paging structures and the data structures used to locate SPP vectors) may result in inconsistencies between those structures and the mappings cached by a logical processor. Certain operations invalidate information cached by a logical processor and can be used to eliminate such inconsistencies.

29.4.3.1 Operations that Invalidate Cached Mappings

The following operations invalidate cached mappings as indicated:

- Operations that architecturally invalidate entries in the TLBs or paging-structure caches independent of VMX operation (e.g., the INVLPG and INVPCID instructions) invalidate linear mappings and combined mappings.³ They are required to do so only for the current VPID (but, for combined mappings, all EPTRTAs). Linear

1. At any given time, a logical processor may be caching combined mappings for a VPID and a PCID that are associated with different EPTRTAs. Similarly, it may be caching combined mappings for an EPTRTA that are associated with different VPIDs and PCIDs.

2. If the capability MSR IA32_VMX_CRO_FIXED0 reports that CR0.PG must be 1 in VMX operation, CR0.PG can be 0 in VMX non-root operation only if the “unrestricted guest” VM-execution control and bit 31 of the primary processor-based VM-execution controls are both 1.

3. See Section 4.10.4, “Invalidation of TLBs and Paging-Structure Caches,” in the Intel® 64 and IA-32 Architectures Software Developer’s Manual, Volume 3A, for an enumeration of operations that architecturally invalidate entries in the TLBs and paging-structure caches independent of VMX operation.

mappings for the current VPID are invalidated even if EPT is in use.¹ Combined mappings for the current VPID are invalidated even if EPT is not in use.²

- An EPT violation invalidates any guest-physical mappings (associated with the current EPTRTA) that would be used to translate the guest-physical address that caused the EPT violation. If that guest-physical address was the translation of a linear address, the EPT violation also invalidates any combined mappings for that linear address associated with the current PCID, the current VPID and the current EPTRTA.
- If the “enable VPID” VM-execution control is 0, VM entries and VM exits invalidate linear mappings and combined mappings associated with VPID 0000H (for all PCIDs). Combined mappings for VPID 0000H are invalidated for all EPTRTAs.
- Execution of the INVVPID instruction invalidates linear mappings and combined mappings. Invalidation is based on instruction operands, called the INVVPID type and the INVVPID descriptor. Four INVVPID types are currently defined:
 - **Individual-address.** If the INVVPID type is 0, the logical processor invalidates linear mappings and combined mappings associated with the VPID specified in the INVVPID descriptor and that would be used to translate the linear address specified in of the INVVPID descriptor. Linear mappings and combined mappings for that VPID and linear address are invalidated for all PCIDs and, for combined mappings, all EPTRTAs. (The instruction may also invalidate mappings associated with other VPIDs and for other linear addresses.)
 - **Single-context.** If the INVVPID type is 1, the logical processor invalidates all linear mappings and combined mappings associated with the VPID specified in the INVVPID descriptor. Linear mappings and combined mappings for that VPID are invalidated for all PCIDs and, for combined mappings, all EPTRTAs. (The instruction may also invalidate mappings associated with other VPIDs.)
 - **All-context.** If the INVVPID type is 2, the logical processor invalidates linear mappings and combined mappings associated with all VPIDs except VPID 0000H and with all PCIDs. (The instruction may also invalidate linear mappings with VPID 0000H.) Combined mappings are invalidated for all EPTRTAs.
 - **Single-context-retaining-globals.** If the INVVPID type is 3, the logical processor invalidates linear mappings and combined mappings associated with the VPID specified in the INVVPID descriptor. Linear mappings and combined mappings for that VPID are invalidated for all PCIDs and, for combined mappings, all EPTRTAs. The logical processor is **not** required to invalidate information that was used for **global** translations (although it may do so). See Section 4.10, “Caching Translation Information,” for details regarding global translations. (The instruction may also invalidate mappings associated with other VPIDs.)

See Chapter 31 for details of the INVVPID instruction. See Section 29.4.3.3 for guidelines regarding use of this instruction.

- Execution of the INVEPT instruction invalidates guest-physical mappings and combined mappings. Invalidation is based on instruction operands, called the INVEPT type and the INVEPT descriptor. Two INVEPT types are currently defined:
 - **Single-context.** If the INVEPT type is 1, the logical processor invalidates all guest-physical mappings and combined mappings associated with the EPTRTA specified in the INVEPT descriptor. Combined mappings for that EPTRTA are invalidated for all VPIDs and all PCIDs. (The instruction may invalidate mappings associated with other EPTRTAs.)
 - **All-context.** If the INVEPT type is 2, the logical processor invalidates guest-physical mappings and combined mappings associated with all EPTRTAs (and, for combined mappings, for all VPIDs and PCIDs).

See Chapter 31 for details of the INVEPT instruction. See Section 29.4.3.4 for guidelines regarding use of this instruction.

- A power-up or a reset invalidates all linear mappings, guest-physical mappings, and combined mappings.

1. While no linear mappings are created while EPT is in use, a logical processor may retain, while EPT is in use, linear mappings (for the same VPID as the current one) there were created earlier, when EPT was not in use.

2. While no combined mappings are created while EPT is not in use, a logical processor may retain, while EPT is in not use, combined mappings (for the same VPID as the current one) there were created earlier, when EPT was in use.

29.4.3.2 Operations that Need Not Invalidate Cached Mappings

The following items detail cases of operations that are not required to invalidate certain cached mappings:

- Operations that architecturally invalidate entries in the TLBs or paging-structure caches independent of VMX operation are not required to invalidate any guest-physical mappings.
- The INVVPID instruction is not required to invalidate any guest-physical mappings.
- The INVEPT instruction is not required to invalidate any linear mappings.
- VMX transitions are not required to invalidate any guest-physical mappings. If the “enable VPID” VM-execution control is 1, VMX transitions are not required to invalidate any linear mappings or combined mappings.
- The VMXOFF and VMXON instructions are not required to invalidate any linear mappings, guest-physical mappings, or combined mappings.

A logical processor may invalidate any cached mappings at any time. For this reason, the operations identified above may invalidate the indicated mappings despite the fact that doing so is not required.

29.4.3.3 Guidelines for Use of the INVVPID Instruction

The need for VMM software to use the INVVPID instruction depends on how that software is virtualizing memory.

If EPT is not in use, it is likely that the VMM is virtualizing the guest paging structures. Such a VMM may configure the VMCS so that all or some of the operations that invalidate entries the TLBs and the paging-structure caches (e.g., the INVLPG instruction) cause VM exits. If VMM software is emulating these operations, it may be necessary to use the INVVPID instruction to ensure that the logical processor’s TLBs and the paging-structure caches are appropriately invalidated.

Requirements of when software should use the INVVPID instruction depend on the specific algorithm being used for page-table virtualization. The following items provide guidelines for software developers:

- Emulation of the INVLPG instruction may require execution of the INVVPID instruction as follows:
 - The INVVPID type is individual-address (0).
 - The VPID in the INVVPID descriptor is the one assigned to the virtual processor whose execution is being emulated.
 - The linear address in the INVVPID descriptor is that of the operand of the INVLPG instruction being emulated.
- Some instructions invalidate all entries in the TLBs and paging-structure caches—except for global translations. An example is the MOV to CR3 instruction. (See Section 4.10, “Caching Translation Information,” in the Intel® 64 and IA-32 Architectures Software Developer’s Manual, Volume 3A, for details regarding global translations.) Emulation of such an instruction may require execution of the INVVPID instruction as follows:
 - The INVVPID type is single-context-retaining-globals (3).
 - The VPID in the INVVPID descriptor is the one assigned to the virtual processor whose execution is being emulated.
- Some instructions invalidate all entries in the TLBs and paging-structure caches—including for global translations. An example is the MOV to CR4 instruction if the value of value of bit 4 (page global enable—PGE) is changing. Emulation of such an instruction may require execution of the INVVPID instruction as follows:
 - The INVVPID type is single-context (1).
 - The VPID in the INVVPID descriptor is the one assigned to the virtual processor whose execution is being emulated.

If EPT is not in use, the logical processor associates all mappings it creates with the current VPID, and it will use such mappings to translate linear addresses. For that reason, a VMM should not use the same VPID for different non-EPT guests that use different page tables. Doing so may result in one guest using translations that pertain to the other.

If EPT is in use, the instructions enumerated above might not be configured to cause VM exits and the VMM might not be emulating them. In that case, executions of the instructions by guest software properly invalidate the

required entries in the TLBs and paging-structure caches (see Section 29.4.3.1); execution of the INVVPID instruction is not required.

If EPT is in use, the logical processor associates all mappings it creates with the value of bits 51:12 of current EPTP. If a VMM uses different EPTP values for different guests, it may use the same VPID for those guests. Doing so cannot result in one guest using translations that pertain to the other.

The following guidelines apply more generally and are appropriate even if EPT is in use:

- As detailed in Section 30.4.5, an access to the APIC-access page might not cause an APIC-access VM exit if software does not properly invalidate information that may be cached from the paging structures. If, at one time, the current VPID on a logical processor was a non-zero value X, it is recommended that software use the INVVPID instruction with the “single-context” INVVPID type and with VPID X in the INVVPID descriptor before a VM entry on the same logical processor that establishes VPID X and either (a) the “virtualize APIC accesses” VM-execution control was changed from 0 to 1; or (b) the value of the APIC-access address was changed.
- Software can use the INVVPID instruction with the “all-context” INVVPID type immediately after execution of the VMXON instruction or immediately prior to execution of the VMXOFF instruction. Either prevents potentially undesired retention of information cached from paging structures between separate uses of VMX operation.

29.4.3.4 Guidelines for Use of the INVEPT Instruction

The following items provide guidelines for use of the INVEPT instruction to invalidate information cached from the EPT paging structures.

- Software should use the INVEPT instruction with the “single-context” INVEPT type after making any of the following changes to an EPT paging-structure entry (the INVEPT descriptor should contain an EPTP value that references — directly or indirectly — the modified EPT paging structure):
 - Changing any of the privilege bits 2:0 from 1 to 0.¹
 - Changing the physical address in bits 51:12.
 - Clearing bit 8 (the accessed flag) if accessed and dirty flags for EPT will be enabled.
 - For an EPT PDPTE or an EPT PDE, changing bit 7 (which determines whether the entry maps a page).
 - For the **last** EPT paging-structure entry used to translate a guest-physical address (an EPT PDPTE with bit 7 set to 1, an EPT PDE with bit 7 set to 1, or an EPT PTE), changing either bits 5:3 or bit 6. (These bits determine the effective memory type of accesses using that EPT paging-structure entry; see Section 29.3.7.)
 - For the **last** EPT paging-structure entry used to translate a guest-physical address (an EPT PDPTE with bit 7 set to 1, an EPT PDE with bit 7 set to 1, or an EPT PTE), clearing bit 9 (the dirty flag) if accessed and dirty flags for EPT will be enabled.
- Software should use the INVEPT instruction with the “single-context” INVEPT type before a VM entry with an EPTP value X such that $X[6] = 1$ (accessed and dirty flags for EPT are enabled) if the logical processor had earlier been in VMX non-root operation with an EPTP value Y such that $Y[6] = 0$ (accessed and dirty flags for EPT are not enabled) and $Y[51:12] = X[51:12]$.
- Software should use the INVEPT instruction with the “single-context” INVEPT type before a VM entry with an EPTP value X if the logical processor had earlier been in VMX non-root operation with an EPTP value Y such that $Y[5:3] \neq X[5:3]$ (different EPT page-walk length) and $Y[51:12] = X[51:12]$.
- Software may use the INVEPT instruction after modifying a present EPT paging-structure entry (see Section 29.3.2) to change any of the privilege bits 2:0 from 0 to 1.² Failure to do so may cause an EPT violation that would not otherwise occur. Because an EPT violation invalidates any mappings that would be used by the access that caused the EPT violation (see Section 29.4.3.1), an EPT violation will not recur if the original access is performed again, even if the INVEPT instruction is not executed.

1. If the “mode-based execute control for EPT” VM-execution control is 1, software should use the INVEPT instruction after changing privilege bit 10 from 1 to 0.

2. If the “mode-based execute control for EPT” VM-execution control is 1, software may use the INVEPT instruction after modifying a present EPT paging-structure entry to change privilege bit 10 from 0 to 1.

- Because a logical processor does not cache any information derived from EPT paging-structure entries that are not present (see Section 29.3.2) or misconfigured (see Section 29.3.3.1), it is not necessary to execute INVEPT following modification of an EPT paging-structure entry that had been not present or misconfigured.
- As detailed in Section 30.4.5, an access to the APIC-access page might not cause an APIC-access VM exit if software does not properly invalidate information that may be cached from the EPT paging structures. If EPT was in use on a logical processor at one time with EPTP X, it is recommended that software use the INVEPT instruction with the “single-context” INVEPT type and with EPTP X in the INVEPT descriptor before a VM entry on the same logical processor that enables EPT with EPTP X and either (a) the “virtualize APIC accesses” VM-execution control was changed from 0 to 1; or (b) the value of the APIC-access address was changed.
- Software can use the INVEPT instruction with the “all-context” INVEPT type immediately after execution of the VMXON instruction or immediately prior to execution of the VMXOFF instruction. Either prevents potentially undesired retention of information cached from EPT paging structures between separate uses of VMX operation.

In a system containing more than one logical processor, software must account for the fact that information from an EPT paging-structure entry may be cached on logical processors other than the one that modifies that entry. The process of propagating the changes to a paging-structure entry is commonly referred to as “TLB shutdown.” A discussion of TLB shutdown appears in Section 4.10.5, “Propagation of Paging-Structure Changes to Multiple Processors,” in the Intel[®] 64 and IA-32 Architectures Software Developer’s Manual, Volume 3A.

CHAPTER 30

APIC VIRTUALIZATION AND VIRTUAL INTERRUPTS

The VMCS includes controls that enable the virtualization of interrupts and the Advanced Programmable Interrupt Controller (APIC).

When these controls are used, the processor will emulate many accesses to the APIC, track the state of the virtual APIC, and deliver virtual interrupts — all in VMX non-root operation with out a VM exit.¹

The processor tracks the state of the virtual APIC using a virtual-APIC page identified by the virtual-machine monitor (VMM). Section 30.1 discusses the virtual-APIC page and how the processor uses it to track the state of the virtual APIC.

The following are the VM-execution controls relevant to APIC virtualization and virtual interrupts (see Section 25.6 for information about the locations of these controls):

- **Virtual-interrupt delivery.** This control enables the evaluation and delivery of pending virtual interrupts (Section 30.2). It also enables the emulation of writes (memory-mapped or MSR-based, as enabled) to the APIC registers that control interrupt prioritization.
- **Use TPR shadow.** This control enables emulation of accesses to the APIC's task-priority register (TPR) via CR8 (Section 30.3) and, if enabled, via the memory-mapped or MSR-based interfaces.
- **Virtualize APIC accesses.** This control enables virtualization of memory-mapped accesses to the APIC (Section 30.4) by causing VM exits on accesses to a VMM-specified APIC-access page. Some of the other controls, if set, may cause some of these accesses to be emulated rather than causing VM exits.
- **Virtualize x2APIC mode.** This control enables virtualization of MSR-based accesses to the APIC (Section 30.5).
- **APIC-register virtualization.** This control allows memory-mapped and MSR-based reads of most APIC registers (as enabled) by satisfying them from the virtual-APIC page. It directs memory-mapped writes to the APIC-access page to the virtual-APIC page, following them by VM exits for VMM emulation.
- **Process posted interrupts.** This control allows software to post virtual interrupts in a data structure and send a notification to another logical processor; upon receipt of the notification, the target processor will process the posted interrupts by copying them into the virtual-APIC page (Section 30.6).
- **IPI virtualization.** This control enables the virtualization of interprocessor interrupts (Section 30.1.6).

"Virtualize APIC accesses", "virtualize x2APIC mode", "virtual-interrupt delivery", and "APIC-register virtualization" are all secondary processor-based VM-execution controls; if bit 31 of the primary processor-based VM-execution controls is 0, the processor operates as if these controls were all 0. "IPI virtualization" is a tertiary processor-based VM-execution control; if bit 17 of the primary processor-based VM-execution controls is 0, the processor operates as if "IPI virtualization" were 0. See Section 25.6.2.

30.1 VIRTUAL APIC STATE

The **virtual-APIC page** is a 4-KByte region of memory that the processor uses to virtualize certain accesses to APIC registers and to manage virtual interrupts. The physical address of the virtual-APIC page is the **virtual-APIC address**, a 64-bit VM-execution control field in the VMCS (see Section 25.6.8).

Depending on the settings of certain VM-execution controls, the processor may virtualize certain fields on the virtual-APIC page with functionality analogous to that performed by the local APIC. Section 30.1.1 identifies and defines these fields. Section 30.1.2, Section 30.1.3, Section 30.1.4, and Section 30.1.5 detail the actions taken to virtualize updates to some of these fields.

With the exception of fields corresponding to virtualized APIC registers (defined in Section 30.1.1), software may modify the virtual-APIC page referenced by the current VMCS of a logical processor in VMX non-root operation. (This is an exception to the general requirement given in Section 25.11.4.)

1. In most cases, it is not necessary for a virtual-machine monitor (VMM) to inject virtual interrupts as part of VM entry.

30.1.1 Virtualized APIC Registers

Depending on the setting of certain VM-execution controls, a logical processor may virtualize certain accesses to APIC registers using the following fields on the virtual-APIC page:

- **Virtual task-priority register (VTPR):** the 32-bit field located at offset 080H on the virtual-APIC page.
- **Virtual processor-priority register (VPPR):** the 32-bit field located at offset 0A0H on the virtual-APIC page.
- **Virtual end-of-interrupt register (VEOI):** the 32-bit field located at offset 0B0H on the virtual-APIC page.
- **Virtual interrupt-service register (VISR):** the 256-bit value comprising eight non-contiguous 32-bit fields at offsets 100H, 110H, 120H, 130H, 140H, 150H, 160H, and 170H on the virtual-APIC page. Bit x of the VISR is at bit position $(x \& 1FH)$ at offset $(100H | ((x \& E0H) \gg 1))$. The processor uses only the low 4 bytes of each of the 16-byte fields at offsets 100H, 110H, 120H, 130H, 140H, 150H, 160H, and 170H.
- **Virtual interrupt-request register (VIRR):** the 256-bit value comprising eight non-contiguous 32-bit fields at offsets 200H, 210H, 220H, 230H, 240H, 250H, 260H, and 270H on the virtual-APIC page. Bit x of the VIRR is at bit position $(x \& 1FH)$ at offset $(200H | ((x \& E0H) \gg 1))$. The processor uses only the low 4 bytes of each of the 16-Byte fields at offsets 200H, 210H, 220H, 230H, 240H, 250H, 260H, and 270H.
- **Virtual interrupt-command register (VICR_LO):** the 32-bit field located at offset 300H on the virtual-APIC page.
- **Virtual interrupt-command register (VICR_HI):** the 32-bit field located at offset 310H on the virtual-APIC page.

The VTPR field virtualizes the TPR whenever the “use TPR shadow” VM-execution control is 1. The other fields indicated above virtualize the corresponding APIC registers whenever the “virtual-interrupt delivery” VM-execution control is 1. (VICR_LO and VICR_HI also virtualize the ICR when the “IPI virtualization” VM-execution control is 1.)

30.1.2 TPR Virtualization

The processor performs **TPR virtualization** in response to the following operations: (1) virtualization of the MOV to CR8 instruction; (2) virtualization of a write to offset 080H on the APIC-access page; and (3) virtualization of the WRMSR instruction with ECX = 808H. See Section 30.3, Section 30.4.3, and Section 30.5 for details of when TPR virtualization is performed.

The following pseudocode details the behavior of TPR virtualization:

```

IF “virtual-interrupt delivery” is 0
  THEN
    IF VTPR[7:4] < TPR threshold (see Section 25.6.8)
      THEN cause VM exit due to TPR below threshold;
    FI;
  ELSE
    perform PPR virtualization (see Section 30.1.3);
    evaluate pending virtual interrupts (see Section 30.2.1);
  FI;

```

Any VM exit caused by TPR virtualization is trap-like: the instruction causing TPR virtualization completes before the VM exit occurs (for example, the value of CS:RIP saved in the guest-state area of the VMCS references the next instruction).

30.1.3 PPR Virtualization

The processor performs **PPR virtualization** in response to the following operations: (1) VM entry; (2) TPR virtualization; and (3) EOI virtualization. See Section 27.3.2.5, Section 30.1.2, and Section 30.1.4 for details of when PPR virtualization is performed.

PPR virtualization uses the guest interrupt status (specifically, SVI; see Section 25.4.2) and VTPR. The following pseudocode details the behavior of PPR virtualization:

```

IF VTPR[7:4] ≥ SVI[7:4]

```

```

    THEN VPPR := VTPR & FFH;
    ELSE VPPR := SVI & FOH;
FI;

```

PPR virtualization always clears bytes 3:1 of VPPR.

PPR virtualization is caused only by TPR virtualization, EOI virtualization, and VM entry. Delivery of a virtual interrupt also modifies VPPR, but in a different way (see Section 30.2.2). No other operations modify VPPR, even if they modify SVI, VISR, or VTPR.

30.1.4 EOI Virtualization

The processor performs **EOI virtualization** in response to the following operations: (1) virtualization of a write to offset 0B0H on the APIC-access page; and (2) virtualization of the WRMSR instruction with ECX = 80BH. See Section 30.4.3 and Section 30.5 for details of when EOI virtualization is performed. EOI virtualization occurs only if the “virtual-interrupt delivery” VM-execution control is 1.

EOI virtualization uses and updates the guest interrupt status (specifically, SVI; see Section 25.4.2). The following pseudocode details the behavior of EOI virtualization:

```

Vector := SVI;
VISR[Vector] := 0; (see Section 30.1.1 for definition of VISR)
IF any bits set in VISR
    THEN SVI := highest index of bit set in VISR
    ELSE SVI := 0;
FI;
perform PPR virtualization (see Section 30.1.3);
IF EOI_exit_bitmap[Vector] = 1 (see Section 25.6.8 for definition of EOI_exit_bitmap)
    THEN cause EOI-induced VM exit with Vector as exit qualification;
    ELSE evaluate pending virtual interrupts; (see Section 30.2.1)
FI;

```

Any VM exit caused by EOI virtualization is trap-like: the instruction causing EOI virtualization completes before the VM exit occurs (for example, the value of CS:RIP saved in the guest-state area of the VMCS references the next instruction).

30.1.5 Self-IPI Virtualization

The processor performs **self-IPI virtualization** in response to the following operations: (1) virtualization of a write to offset 300H on the APIC-access page; and (2) virtualization of the WRMSR instruction with ECX = 83FH. See Section 30.4.3 and Section 30.5 for details of when self-IPI virtualization is performed. Self-IPI virtualization occurs only if the “virtual-interrupt delivery” VM-execution control is 1.

Each operation that leads to self-IPI virtualization provides an 8-bit vector (see Section 30.4.3 and Section 30.5). Self-IPI virtualization updates the guest interrupt status (specifically, RVI; see Section 25.4.2). The following pseudocode details the behavior of self-IPI virtualization:

```

VIRR[Vector] := 1; (see Section 30.1.1 for definition of VIRR)
RVI := max[RVI, Vector];
evaluate pending virtual interrupts; (see Section 30.2.1)

```

30.1.6 IPI Virtualization

The processor performs **IPI virtualization** in response to the following operations: (1) virtualization of a write to offset 300H on the APIC-access page (Section 30.4.3); (2) virtualization of the WRMSR instruction with ECX = 830H (Section 30.5); and (3) virtualization of some executions of SENDUIPI (Section 30.7). IPI virtualization occurs only if the “IPI virtualization” VM-execution control is 1.

Each operation that leads to IPI virtualization provides an 8-bit virtual vector *V* and a 32-bit virtual APIC ID *T*. IPI virtualization uses those values to initiate the indicated virtual IPI using the PID-pointer table. (Recall that the PID-pointer table address is a field in the VMCS, as is the last PID-pointer index.)

Specifically, the CPU uses the virtual APIC ID to select an entry from the PID-pointer table. It uses the address in that entry to locate a posted-interrupt descriptor (PID) and then posts a virtual interrupt with vector *V* in that PID. The following pseudocode details the behavior of self-IPI virtualization:

```

IF V < 16
  THEN APIC-write VM exit; // illegal vector
ELSE IF T ≤ last PID-pointer index
  THEN
    PID_ADDR := 8 bytes at (PID-pointer table address + (T << 3));
    IF PID_ADDR sets bits beyond the processor's physical-address width OR
      PID_ADDR[5:0] ≠ 000001b // PID pointer not valid or reserved bits set
    THEN APIC-write VM exit; // See Section 30.4.3.3
    ELSE
      PIR := 32 bytes at PID_ADDR; // under lock
      PIR[V] := 1;
      store PIR at PID_ADDR; // release lock
      NotifyInfo := 8 bytes at PID_ADDR + 32; // under lock
      IF NotifyInfo.ON = 0 AND NotifyInfo.SN = 0
        THEN
          NotifyInfo.ON := 1;
          SendNotify := 1;
          ELSE SendNotify := 0;
      FI;
      store NotifyInfo at PID_ADDR + 32; // release lock
      IF SendNotify = 1
        THEN send an IPI specified by NotifyInfo.NDST and NotifyInfo.NV;
      FI;
    FI;
  ELSE APIC-write VM exit; // virtual APIC ID beyond end of tables
FI;

```

The sending of the notification IPI is indicated by fields in the selected PID: NDST (PID[319:288]) and NV (PID[279:272]):

- If the local APIC is in xAPIC mode, this is the IPI that would be generated by writing NDST[15:8] (PID[303:296]) to ICR_HI[31:24] (offset 310H from IA32_APIC_BASE) and then writing NV to ICR_LO (offset 300H from IA32_APIC_BASE).
- If the local APIC is in x2APIC mode, this is the IPI that would be generated by executing WRMSR with ECX = 830H (ICR), EAX = NV, and EDX = NDST.

If the pseudocode specifies an APIC-write VM exit, this VM exit occurs as if there had been a write access to page offset 300H on the APIC-access page (see Section 30.4.3.3).

30.2 EVALUATION AND DELIVERY OF VIRTUAL INTERRUPTS

If the “virtual-interrupt delivery” VM-execution control is 1, certain actions in VMX non-root operation or during VM entry cause the processor to evaluate and deliver virtual interrupts.

Evaluation of virtual interrupts is triggered by certain actions change the state of the virtual-APIC page and is described in Section 30.2.1. This evaluation may result in recognition of a virtual interrupt. Once a virtual interrupt is recognized, the processor may deliver it within VMX non-root operation without a VM exit. Virtual-interrupt delivery is described in Section 30.2.2.

30.2.1 Evaluation of Pending Virtual Interrupts

If the “virtual-interrupt delivery” VM-execution control is 1, certain actions cause a logical processor to **evaluate pending virtual interrupts**.

The following actions cause the evaluation of pending virtual interrupts: VM entry; TPR virtualization; EOI virtualization; self-IPI virtualization; and posted-interrupt processing. See Section 27.3.2.5, Section 30.1.2, Section

30.1.4, Section 30.1.5, and Section 30.6 for details of when evaluation of pending virtual interrupts is performed. No other operations cause the evaluation of pending virtual interrupts, even if they modify RVI or VPPR.

Evaluation of pending virtual interrupts uses the guest interrupt status (specifically, RVI; see Section 25.4.2). The following pseudocode details the evaluation of pending virtual interrupts:

```
IF "interrupt-window exiting" is 0 AND
  RVI[7:4] > VPPR[7:4] (see Section 30.1.1 for definition of VPPR)
  THEN recognize a pending virtual interrupt;
ELSE
  do not recognize a pending virtual interrupt;
FI;
```

Once recognized, a virtual interrupt may be delivered in VMX non-root operation; see Section 30.2.2.

Evaluation of pending virtual interrupts is caused only by VM entry, TPR virtualization, EOI virtualization, self-IPI virtualization, and posted-interrupt processing. No other operations do so, even if they modify RVI or VPPR. The logical processor ceases recognition of a pending virtual interrupt following the delivery of a virtual interrupt.

30.2.2 Virtual-Interrupt Delivery

If a virtual interrupt has been recognized (see Section 30.2.1), it is delivered at an instruction boundary when the following conditions all hold: (1) RFLAGS.IF = 1; (2) there is no blocking by STI; (3) there is no blocking by MOV SS or by POP SS; and (4) the "interrupt-window exiting" VM-execution control is 0.

Virtual-interrupt delivery has the same priority as that of VM exits due to the 1-setting of the "interrupt-window exiting" VM-execution control.¹ Thus, non-maskable interrupts (NMIs) and higher priority events take priority over delivery of a virtual interrupt; delivery of a virtual interrupt takes priority over external interrupts and lower priority events.

Virtual-interrupt delivery wakes a logical processor from the same inactive activity states as would an external interrupt. Specifically, it wakes a logical processor from the states entered using the HLT and MWAIT instructions. It does not wake a logical processor in the shutdown state or in the wait-for-SIPI state.

Virtual-interrupt delivery updates the guest interrupt status (both RVI and SVI; see Section 25.4.2) and delivers an event within VMX non-root operation without a VM exit. The following pseudocode details the behavior of virtual-interrupt delivery (see Section 30.1.1 for definition of VISR, VIRR, and VPPR):

```
Vector := RVI;
VISR[Vector] := 1;
SVI := Vector;
VPPR := Vector & FOH;
VIRR[Vector] := 0;
IF any bits set in VIRR
  THEN RVI := highest index of bit set in VIRR
  ELSE RVI := 0;
FI;
cease recognition of any pending virtual interrupt;
IF transactional execution is in effect
  THEN abort transactional execution and transition to a non-transactional execution;
FI;
IF logical processor is in enclave mode
  THEN cause an Asynchronous Enclave Exit (AEX) (see Chapter 37, "Enclave Exiting Events")
FI;
IF CR4.UINTR = 1 AND IA32_EFER.LMA = 1 AND Vector = UINV
  THEN virtualize user-interrupt notification identification and processing (see Section 30.2.3)
  ELSE deliver interrupt with Vector through IDT;
```

1. A logical processor never recognizes or delivers a virtual interrupt if the "interrupt-window exiting" VM-execution control is 1. Because of this, the relative priority of virtual-interrupt delivery and VM exits due to the 1-setting of that control is not defined.

FI;

30.2.3 Virtualizing User-Interrupt Notifications

Section 7.5 describes the process of user-interrupt notification identification and processing. If the “virtual-interrupt delivery” VM-execution control is 1, this process is modified as described in the following paragraphs.

The virtualized form of user-interrupt notification identification begins as described in Section 30.2.2. Following this, instead of writing zero to the EOI register in the local APIC, the logical processor performs the initial steps of EOI virtualization:

```
VISR[V] := 0;
IF any bit is set in VISR
  THEN SVI := highest index of bit set in VISR
  ELSE SVI := 0;
FI;
perform PPR virtualization (Section 30.1.3);
```

Unlike EOI virtualization resulting from a guest write to the EOI register (as defined for virtual-interrupt delivery), the logical processor does not check the EOI-exit bitmap as part of this modified form of user-interrupt notification identification, and the corresponding VM exits cannot occur.

Following this modified form of user-interrupt notification identification, the logical processor then performs user-interrupt notification processing as specified in Section 7.5.2.

A logical processor is not interruptible during this modified form of user-interrupt notification identification or between it and any subsequent user-interrupt notification processing.

If the user-interrupt notification identification that precedes user-interrupt notification processing occurred while the logical processor was in the HLT state, the logical processor returns to the HLT state following user-interrupt notification processing.

30.3 VIRTUALIZING CR8-BASED TPR ACCESSES

In 64-bit mode, software can access the local APIC’s task-priority register (TPR) through CR8. Specifically, software uses the MOV from CR8 and MOV to CR8 instructions (see Section 11.8.6, “Task Priority in IA-32e Mode”). This section describes how these accesses can be virtualized.

A virtual-machine monitor can virtualize these CR8-based APIC accesses by setting the “CR8-load exiting” and “CR8-store exiting” VM-execution controls, ensuring that the accesses cause VM exits (see Section 26.1.3). Alternatively, there are methods for virtualizing some CR8-based APIC accesses without VM exits.

Normally, an execution of MOV from CR8 or MOV to CR8 that does not fault or cause a VM exit accesses the APIC’s TPR. However, such an execution are treated specially if the “use TPR shadow” VM-execution control is 1. The following items provide details:

- **MOV from CR8.** The instruction loads bits 3:0 of its destination operand with bits 7:4 of VTPR (see Section 30.1.1). Bits 63:4 of the destination operand are cleared.
- **MOV to CR8.** The instruction stores bits 3:0 of its source operand into bits 7:4 of VTPR; the remainder of VTPR (bits 3:0 and bits 31:8) are cleared. Following this, the processor performs TPR virtualization (see Section 30.1.2).

30.4 VIRTUALIZING MEMORY-MAPPED APIC ACCESSES

When the local APIC is in xAPIC mode, software accesses the local APIC’s control registers using a memory-mapped interface. Specifically, software uses linear addresses that translate to physical addresses on page frame indicated by the base address in the IA32_APIC_BASE MSR (see Section 11.4.4, “Local APIC Status and Location”). This section describes how these accesses can be virtualized.

A virtual-machine monitor (VMM) can virtualize these memory-mapped APIC accesses by ensuring that any access to a linear address that would access the local APIC instead causes a VM exit. This could be done using paging or the extended page-table mechanism (EPT). Another way is by using the 1-setting of the “virtualize APIC accesses” VM-execution control.

If the “virtualize APIC accesses” VM-execution control is 1, the logical processor treats specially memory accesses using linear addresses that translate to physical addresses in the 4-KByte **APIC-access page**.^{1,2} (The APIC-access page is identified by the **APIC-access address**, a field in the VMCS; see Section 25.6.8.)

In general, an access to the APIC-access page causes an **APIC-access VM exit**. APIC-access VM exits provide a VMM with information about the access causing the VM exit. Section 30.4.1 discusses the priority of APIC-access VM exits.

Certain VM-execution controls enable the processor to virtualize certain accesses to the APIC-access page without a VM exit. In general, this virtualization causes these accesses to be made to the virtual-APIC page instead of the APIC-access page.

NOTES

Unless stated otherwise, this section characterizes only linear accesses to the APIC-access page; an access to the APIC-access page is a linear access if (1) it results from a memory access using a linear address; and (2) the access’s physical address is the translation of that linear address. Section 30.4.6 discusses accesses to the APIC-access page that are not linear accesses.

The distinction between the APIC-access page and the virtual-APIC page allows a VMM to share paging structures or EPT paging structures among the virtual processors of a virtual machine (the shared paging structures referencing the same APIC-access address, which appears in the VMCS of all the virtual processors) while giving each virtual processor its own virtual APIC (the VMCS of each virtual processor will have a unique virtual-APIC address).

Section 30.4.2 discusses when and how the processor may virtualize read accesses from the APIC-access page. Section 30.4.3 does the same for write accesses. When virtualizing a write to the APIC-access page, the processor typically takes actions in addition to passing the write through to the virtual-APIC page.

The discussion in those sections uses the concept of an **operation** within which these memory accesses may occur. For those discussions, an “operation” can be an iteration of a REP-prefixed string instruction, an execution of any other instruction, or delivery of an event through the IDT.

The 1-setting of the “virtualize APIC accesses” VM-execution control may also affect accesses to the APIC-access page that do not result directly from linear addresses. This is discussed in Section 30.4.6.

Special treatment may apply to Intel SGX instructions or if the logical processor is in enclave mode. See Section 39.5.3 for details.

30.4.1 Priority of APIC-Access VM Exits

The following items specify the priority of APIC-access VM exits relative to other events.

- The priority of an APIC-access VM exit due to a memory access is below that of any page fault or EPT violation that that access may incur. That is, an access does not cause an APIC-access VM exit if it would cause a page fault or an EPT violation.

1. Even when addresses are translated using EPT (see Section 29.3), the determination of whether an APIC-access VM exit occurs depends on an access’s physical address, not its guest-physical address. Even when CR0.PG = 0, ordinary memory accesses by software use linear addresses; the fact that CR0.PG = 0 means only that the identity translation is used to convert linear addresses to physical (or guest-physical) addresses.

2. If EPT is enabled and there is write to a guest-physical address that translates to an address on the APIC-access page that is eligible for sub-page write permissions (see Section 29.3.4.1), the processor may treat the write as if the “virtualize APIC accesses” VM-execution control were 0 (and not apply the treatment specified in this section). For that reason, it is recommended that software not configure any guest-physical address that translates to an address on the APIC-access page to be eligible for sub-page write permissions.

- A memory access does not cause an APIC-access VM exit until after the accessed flags are set in the paging structures (including EPT paging structures, if enabled).
- A write access does not cause an APIC-access VM exit until after the dirty flags are set in the appropriate paging structure and EPT paging structure (if enabled).
- With respect to all other events, any APIC-access VM exit due to a memory access has the same priority as any page fault or EPT violation that the access could cause. (This item applies to other events that the access may generate as well as events that may be generated by other accesses by the same operation.)

These principles imply, among other things, that an APIC-access VM exit may occur during the execution of a repeated string instruction (including `INS` and `OUTS`). Suppose, for example, that the first n iterations (n may be 0) of such an instruction do not access the APIC-access page and that the next iteration does access that page. As a result, the first n iterations may complete and be followed by an APIC-access VM exit. The instruction pointer saved in the VMCS references the repeated string instruction and the values of the general-purpose registers reflect the completion of n iterations.

30.4.2 Virtualizing Reads from the APIC-Access Page

A read access from the APIC-access page causes an APIC-access VM exit if any of the following are true:

- The “use TPR shadow” VM-execution control is 0.
- The access is for an instruction fetch.
- The access is more than 32 bits in size.
- The access is part of an operation for which the processor has already virtualized a write to the APIC-access page.
- The access is not entirely contained within the low 4 bytes of a naturally aligned 16-byte region. That is, bits 3:2 of the access’s address are 0, and the same is true of the address of the highest byte accessed.

If none of the above are true, whether a read access is virtualized depends on the setting of the “APIC-register virtualization” and “virtual-interrupt delivery” VM-execution controls:

- A read access is virtualized if its page offset is 080H (task priority) regardless of the settings of the “APIC-register virtualization” and “virtual-interrupt delivery” VM-execution controls.
- If the “virtual-interrupt delivery” VM-execution control is 1, a read access is virtualized if its page offset is 0B0H (end of interrupt) or 300H (interrupt command — low).
- If “APIC-register virtualization” is 1, a read access is virtualized if it is entirely within one the following ranges of offsets:
 - 020H–023H (local APIC ID);
 - 030H–033H (local APIC version);
 - 080H–083H (task priority);
 - 0B0H–0B3H (end of interrupt);
 - 0D0H–0D3H (logical destination);
 - 0E0H–0E3H (destination format);
 - 0F0H–0F3H (spurious-interrupt vector);
 - 100H–103H, 110H–113H, 120H–123H, 130H–133H, 140H–143H, 150H–153H, 160H–163H, or 170H–173H (in-service);
 - 180H–183H, 190H–193H, 1A0H–1A3H, 1B0H–1B3H, 1C0H–1C3H, 1D0H–1D3H, 1E0H–1E3H, or 1F0H–1F3H (trigger mode);
 - 200H–203H, 210H–213H, 220H–223H, 230H–233H, 240H–243H, 250H–253H, 260H–263H, or 270H–273H (interrupt request);
 - 280H–283H (error status);
 - 300H–303H or 310H–313H (interrupt command);

- 320H–323H, 330H–333H, 340H–343H, 350H–353H, 360H–363H, or 370H–373H (LVT entries);
- 380H–383H (initial count); or
- 3E0H–3E3H (divide configuration).

In all other cases, the access causes an APIC-access VM exit.

A read access from the APIC-access page that is virtualized returns data from the corresponding page offset on the virtual-APIC page.¹

30.4.3 Virtualizing Writes to the APIC-Access Page

Whether a write access to the APIC-access page is virtualized depends on the settings of the VM-execution controls and the page offset of the access. Section 30.4.3.1 details when APIC-write virtualization occurs.

Unlike reads, writes to the local APIC have side effects; because of this, virtualization of writes to the APIC-access page may require emulation specific to the access's page offset (which identifies the APIC register being accessed). Section 30.4.3.2 describes this **APIC-write emulation**.

For some page offsets, it is necessary for software to complete the virtualization after a write completes. In these cases, the processor causes an **APIC-write VM exit** to invoke VMM software. Section 30.4.3.3 discusses APIC-write VM exits.

30.4.3.1 Determining Whether a Write Access is Virtualized

A write access to the APIC-access page causes an APIC-access VM exit if any of the following are true:

- The "use TPR shadow" VM-execution control is 0.
- The access is more than 32 bits in size.
- The access is part of an operation for which the processor has already virtualized a write (with a different page offset or a different size) to the APIC-access page.
- The access is not entirely contained within the low 4 bytes of a naturally aligned 16-byte region. That is, bits 3:2 of the access's address are 0, and the same is true of the address of the highest byte accessed.

If none of the above are true, whether a write access is virtualized depends on the settings of the "APIC-register virtualization", "virtual-interrupt delivery", and "IPI virtualization" VM-execution controls:

- A write access is virtualized if its page offset is 080H (task priority) regardless of the settings of the "APIC-register virtualization" and "virtual-interrupt delivery" VM-execution controls.
- If the "virtual-interrupt delivery" VM-execution control is 1, a write access is virtualized if its page offset is 0B0H (end of interrupt) or 300H (interrupt command — low).
- If the "IPI virtualization" VM-execution control is 1, a write access is virtualized if its page offset is 300H.
- If the "APIC-register virtualization" VM-execution control is 1, a write access is virtualized if it is entirely within one the following ranges of offsets:
 - 020H–023H (local APIC ID);
 - 080H–083H (task priority);
 - 0B0H–0B3H (end of interrupt);
 - 0D0H–0D3H (logical destination);
 - 0E0H–0E3H (destination format);
 - 0F0H–0F3H (spurious-interrupt vector);
 - 280H–283H (error status);
 - 300H–303H or 310H–313H (interrupt command);

1. The memory type used for accesses that read from the virtual-APIC page is reported in bits 53:50 of the IA32_VMX_BASIC MSR (see Appendix A.1).

- 320H–323H, 330H–333H, 340H–343H, 350H–353H, 360H–363H, or 370H–373H (LVT entries);
- 380H–383H (initial count); or
- 3E0H–3E3H (divide configuration).

In all other cases, the access causes an APIC-access VM exit.

The processor virtualizes a write access to the APIC-access page by writing data to the corresponding page offset on the virtual-APIC page.¹ Following this, the processor performs certain actions after completion of the operation of which the access was a part.² APIC-write emulation is described in Section 30.4.3.2.

30.4.3.2 APIC-Write Emulation

If the processor virtualizes a write access to the APIC-access page, it performs additional actions after completion of an operation of which the access was a part. These actions are called **APIC-write emulation**.

The details of APIC-write emulation depend upon the page offset of the virtualized write access:³

- 080H (task priority). The processor clears bytes 3:1 of VTPR and then causes TPR virtualization (Section 30.1.2).
- 0B0H (end of interrupt). If the “virtual-interrupt delivery” VM-execution control is 1, the processor clears VEOI and then causes EOI virtualization (Section 30.1.4); otherwise, the processor causes an APIC-write VM exit (Section 30.4.3.3).
- 300H (interrupt command — low). If the “virtual-interrupt delivery” VM-execution control is 1, the processor checks the value of VICR_LO to determine whether the following are all true:
 - Reserved bits (31:20, 17:16, 13) and bit 12 (delivery status) are all 0.
 - Bits 19:18 (destination shorthand) are 01B (self).
 - Bit 15 (trigger mode) is 0 (edge).
 - Bits 10:8 (delivery mode) are 000B (fixed).
 - Bits 7:4 (the upper half of the vector) are **not** 0000B.

If all of the items above are true, the processor performs self-IPI virtualization using the 8-bit vector in byte 0 of VICR_LO (Section 30.1.5).

If the “virtual-interrupt delivery” VM-execution control is 0, or if any of the items above are false, behavior depends on the setting of the “IPI virtualization” VM-execution control:

- If the “IPI virtualization” VM-execution control is 1, the processor checks the value of VICR_LO to determine whether the following are all true:
 - Reserved bits (31:20, 17:16, 13) and bit 12 (delivery status) are all 0.
 - Bits 19:18 (destination shorthand) are 00B (no shorthand).
 - Bit 15 (trigger mode) is 0 (edge).
 - Bit 11 (destination mode) is 0 (physical).
 - Bits 10:8 (delivery mode) are 000B (fixed).

If all of the items above are true, the processor performs IPI virtualization using the 8-bit vector in byte 0 of VICR_LO and the 8-bit APIC ID in VICR_HI[31:24] (Section 30.1.6); otherwise, the processor causes an APIC-write VM exit.

- If the “IPI virtualization” VM-execution control is 0, the processor causes an APIC-write VM exit.

1. The memory type used for accesses that write to the virtual-APIC page is reported in bits 53:50 of the IA32_VMX_BASIC MSR (see Appendix A.1).

2. Recall that, for the purposes of this discussion, an operation is an iteration of a REP-prefixed string instruction, an execution of any other instruction, or delivery of an event through the IDT.

3. For any operation, there can be only one page offset for which a write access was virtualized. This is because a write access is not virtualized if the processor has already virtualized a write access for the same operation with a different page offset.

- 310H–313H (interrupt command — high). The processor clears bytes 2:0 of VICR_HI. No other virtualization or VM exit occurs.
- Any other page offset. The processor causes an APIC-write VM exit.

APIC-write emulation takes priority over system-management interrupts (SMIs), INIT signals, and lower priority events. APIC-write emulation is not blocked if RFLAGS.IF = 0 or by the MOV SS, POP SS, or STI instructions.

If an operation causes a fault after a write access to the APIC-access page and before APIC-write emulation, and that fault is delivered without a VM exit, APIC-write emulation occurs after the fault is delivered and before the fault handler can execute. If an operation causes a VM exit (perhaps due to a fault) after a write access to the APIC-access page and before APIC-write emulation, the APIC-write emulation does not occur.

30.4.3.3 APIC-Write VM Exits

In certain cases, VMM software must be invoked to complete the virtualization of a write access to the APIC-access page. In this case, APIC-write emulation causes an **APIC-write VM exit**. (Section 30.4.3.2 details the cases that causes APIC-write VM exits.)

APIC-write VM exits are invoked by APIC-write emulation, and APIC-write emulation occurs after an operation that performs a write access to the APIC-access page. Because of this, every APIC-write VM exit is trap-like: it occurs after completion of the operation containing the write access that caused the VM exit (for example, the value of CS:RIP saved in the guest-state area of the VMCS references the next instruction).

The basic exit reason for an APIC-write VM exit is “APIC write.” The exit qualification is the page offset of the write access that led to the VM exit.

As noted in Section 30.5, execution of WRMSR with ECX = 83FH (self-IPI MSR) can lead to an APIC-write VM exit if the “virtual-interrupt delivery” VM-execution control is 1; the exit qualification for the APIC-write VM exit is 3F0H. As noted in Section 30.1.6 and in Section 30.7, IPI virtualization and execution of SENDIPI may lead to APIC-write VM exits; these VM exits produce an exit qualification of 300H.

30.4.4 Instruction-Specific Considerations

Certain instructions that use linear address may cause page faults even though they do not use those addresses to access memory. The APIC-virtualization features may affect these instructions as well:

- **CLFLUSH, CLFLUSHOPT.** With regard to faulting, the processor operates as if each of these instructions reads from the linear address in its source operand. If that address translates to one on the APIC-access page, the instruction may cause an APIC-access VM exit. If it does not, it will flush the corresponding cache line on the virtual-APIC page instead of the APIC-access page.
- **ENTER.** With regard to faulting, the processor operates if ENTER writes to the byte referenced by the final value of the stack pointer (even though it does not if its size operand is non-zero). If that value translates to an address on the APIC-access page, the instruction may cause an APIC-access VM exit. If it does not, it will cause the APIC-write emulation appropriate to the address’s page offset.
- **MASKMOVQ and MASKMOVDQU.** Even if the instruction’s mask is zero, the processor may operate with regard to faulting as if MASKMOVQ or MASKMOVDQU writes to memory (the behavior is implementation-specific). In such a situation, an APIC-access VM exit may occur.
- **MONITOR.** With regard to faulting, the processor operates as if MONITOR reads from the effective address in RAX. If the resulting linear address translates to one on the APIC-access page, the instruction may cause an APIC-access VM exit.¹ If it does not, it will monitor the corresponding address on the virtual-APIC page instead of the APIC-access page.
- **PREFETCH.** An execution of the PREFETCH instruction that would result in an access to the APIC-access page does not cause an APIC-access VM exit. Such an access may prefetch data; if so, it is from the corresponding address on the virtual-APIC page.

1. This chapter uses the notation RAX, RIP, RSP, RFLAGS, etc. for processor registers because most processors that support VMX operation also support Intel 64 architecture. For IA-32 processors, this notation refers to the 32-bit forms of those registers (EAX, EIP, ESP, EFLAGS, etc.). In a few places, notation such as EAX is used to refer specifically to lower 32 bits of the indicated register.

Virtualization of accesses to the APIC-access page is principally intended for basic instructions such as AND, MOV, OR, TEST, XCHG, and XOR. Use of an instruction that normally operates on floating-point, SSE, AVX, or AVX-512 registers may cause an APIC-access VM exit unconditionally regardless of the page offset it accesses on the APIC-access page.

30.4.5 Issues Pertaining to Page Size and TLB Management

The 1-setting of the “virtualize APIC accesses” VM-execution is guaranteed to apply only if translations to the APIC-access address use a 4-KByte page. The following items provide details:

- If EPT is not in use, any linear address that translates to an address on the APIC-access page should use a 4-KByte page. Any access to a linear address that translates to the APIC-access page using a larger page may operate as if the “virtualize APIC accesses” VM-execution control were 0.
- If EPT is in use, any guest-physical address that translates to an address on the APIC-access page should use a 4-KByte page. Any access to a linear address that translates to a guest-physical address that in turn translates to the APIC-access page using a larger page may operate as if the “virtualize APIC accesses” VM-execution control were 0. (This is true also for guest-physical accesses to the APIC-access page; see Section 30.4.6.1.)

In addition, software should perform appropriate TLB invalidation when making changes that may affect APIC-virtualization. The specifics depend on whether VPIDs or EPT is being used:

- **VPIDs being used but EPT not being used.** Suppose that there is a VPID that has been used before and that software has since made either of the following changes: (1) set the “virtualize APIC accesses” VM-execution control when it had previously been 0; or (2) changed the paging structures so that some linear address translates to the APIC-access address when it previously did not. In that case, software should execute INVVPID (see “INVVPID— Invalidate Translations Based on VPID” in Section 31.3) before performing on the same logical processor and with the same VPID.¹
- **EPT being used.** Suppose that there is an EPTP value that has been used before and that software has since made either of the following changes: (1) set the “virtualize APIC accesses” VM-execution control when it had previously been 0; or (2) changed the EPT paging structures so that some guest-physical address translates to the APIC-access address when it previously did not. In that case, software should execute INVEPT (see “INVEPT— Invalidate Translations Derived from EPT” in Section 31.3) before performing on the same logical processor and with the same EPTP value.²
- **Neither VPIDs nor EPT being used.** No invalidation is required.

Failure to perform the appropriate TLB invalidation may result in the logical processor operating as if the “virtualize APIC accesses” VM-execution control were 0 in responses to accesses to the affected address. (No invalidation is necessary if neither VPIDs nor EPT is being used.)

30.4.6 APIC Accesses Not Directly Resulting From Linear Addresses

Section 30.4 has described the treatment of accesses that use linear addresses that translate to addresses on the APIC-access page. This section considers memory accesses that do not result directly from linear addresses.

- An access is called a **guest-physical access** if (1) CR0.PG = 1;³ (2) the “enable EPT” VM-execution control is 1;⁴ (3) the access’s physical address is the result of an EPT translation; and (4) either (a) the access was not generated by a linear address; or (b) the access’s guest-physical address is not the translation of the access’s linear address. Section 30.4.6.1 discusses the treatment of guest-physical accesses to the APIC-access page.

1. INVVPID should use either (1) the all-contexts INVVPID type; (2) the single-context INVVPID type with the VPID in the INVVPID descriptor; or (3) the individual-address INVVPID type with the linear address and the VPID in the INVVPID descriptor.

2. INVEPT should use either (1) the global INVEPT type; or (2) the single-context INVEPT type with the EPTP value in the INVEPT descriptor.

3. If the capability MSR IA32_VMX_CRO_FIXED0 reports that CR0.PG must be 1 in VMX operation, CR0.PG must be 1 unless the “unrestricted guest” VM-execution control and bit 31 of the primary processor-based VM-execution controls are both 1.

4. “Enable EPT” is a secondary processor-based VM-execution control. If bit 31 of the primary processor-based VM-execution controls is 0, VMX non-root operation functions as if the “enable EPT” VM-execution control were 0. See Section 25.6.2.

- An access is called a **physical access** if (1) either (a) the “enable EPT” VM-execution control is 0; or (b) the access’s physical address is not the result of a translation through the EPT paging structures; and (2) either (a) the access is not generated by a linear address; or (b) the access’s physical address is not the translation of its linear address. Section 30.4.6.2 discusses the treatment of physical accesses to the APIC-access page.

30.4.6.1 Guest-Physical Accesses to the APIC-Access Page

Guest-physical accesses include the following when guest-physical addresses are being translated using EPT:

- Reads from the guest paging structures when translating a linear address (such an access uses a guest-physical address that is not the translation of that linear address).
- Loads of the page-directory-pointer-table entries by MOV to CR when the logical processor is using (or that causes the logical processor to use) PAE paging (see Section 4.4).
- Updates to the accessed and dirty flags in the guest paging structures when using a linear address (such an access uses a guest-physical address that is not the translation of that linear address).
- Memory accesses by Intel Processor Trace when the “Intel PT uses guest physical addresses” VM-execution control is 1 (see Section 26.5.4).

Every guest-physical access using a guest-physical address that translates to an address on the APIC-access page causes an APIC-access VM exit. Such accesses are never virtualized regardless of the page offset.

The following items specify the priority relative to other events of APIC-access VM exits caused by guest-physical accesses to the APIC-access page.

- The priority of an APIC-access VM exit caused by a guest-physical access to memory is below that of any EPT violation that that access may incur. That is, a guest-physical access does not cause an APIC-access VM exit if it would cause an EPT violation.
- With respect to all other events, any APIC-access VM exit caused by a guest-physical access has the same priority as any EPT violation that the guest-physical access could cause.

30.4.6.2 Physical Accesses to the APIC-Access Page

Physical accesses include the following:

- If the “enable EPT” VM-execution control is 0:
 - Reads from the paging structures when translating a linear address.
 - Loads of the page-directory-pointer-table entries by MOV to CR when the logical processor is using (or that causes the logical processor to use) PAE paging (see Section 4.4).
 - Updates to the accessed and dirty flags in the paging structures.
- If the “enable EPT” VM-execution control is 1, accesses to the EPT paging structures (including updates to the accessed and dirty flags for EPT).
- Any of the following accesses made by the processor to support VMX non-root operation:
 - Accesses to the VMCS region.
 - Accesses to data structures referenced (directly or indirectly) by physical addresses in VM-execution control fields in the VMCS. These include the I/O bitmaps, the MSR bitmaps, and the virtual-APIC page.
- Accesses that effect transitions into and out of SMM.¹ These include the following:
 - Accesses to SMRAM during SMI delivery and during execution of RSM.
 - Accesses during SMM VM exits (including accesses to MSEG) and during VM entries that return from SMM.

A physical access to the APIC-access page may or may not cause an APIC-access VM exit. If it does not cause an APIC-access VM exit, it may access the APIC-access page or the virtual-APIC page. Physical write accesses to the APIC-access page may or may not cause APIC-write emulation or APIC-write VM exits.

1. Technically, these accesses do not occur in VMX non-root operation. They are included here for clarity.

The priority of an APIC-access VM exit caused by physical access is not defined relative to other events that the access may cause.

It is recommended that software not set the APIC-access address to any of the addresses used by physical memory accesses (identified above). For example, it should not set the APIC-access address to the physical address of any of the active paging structures if the “enable EPT” VM-execution control is 0.

30.5 VIRTUALIZING MSR-BASED APIC ACCESSES

When the local APIC is in x2APIC mode, software accesses the local APIC’s control registers using the MSR interface. Specifically, software uses the RDMSR and WRMSR instructions, setting ECX (identifying the MSR being accessed) to values in the range 800H–8FFH (see Section 11.12, “Extended XAPIC (x2APIC)”). This section describes how these accesses can be virtualized.

A virtual-machine monitor can virtualize these MSR-based APIC accesses by configuring the MSR bitmaps (see Section 25.6.9) to ensure that the accesses cause VM exits (see Section 26.1.3). Alternatively, there are methods for virtualizing some MSR-based APIC accesses without VM exits.

Normally, an execution of RDMSR or WRMSR that does not fault or cause a VM exit accesses the MSR indicated in ECX. However, such an execution treats some values of ECX in the range 800H–8FFH specially if the “virtualize x2APIC mode” VM-execution control is 1. The following items provide details:

- **RDMSR.** The instruction’s behavior depends on the setting of the “APIC-register virtualization” VM-execution control.
 - If the “APIC-register virtualization” VM-execution control is 0, behavior depends upon the value of ECX.
 - If ECX contains 808H (indicating the TPR MSR), the instruction reads the 8 bytes from offset 080H on the virtual-APIC page (VTPR and the 4 bytes above it) into EDX:EAX. This occurs even if the local APIC is not in x2APIC mode (no general-protection fault occurs because the local APIC is not x2APIC mode).
 - If ECX contains any other value in the range 800H–8FFH, the instruction operates normally. If the local APIC is in x2APIC mode and ECX indicates a readable APIC register, EDX and EAX are loaded with the value of that register. If the local APIC is not in x2APIC mode or ECX does not indicate a readable APIC register, a general-protection fault occurs.
 - If “APIC-register virtualization” is 1 and ECX contains a value in the range 800H–8FFH, the instruction reads the 8 bytes from offset X on the virtual-APIC page into EDX:EAX, where $X = (ECX \& FFH) \ll 4$. This occurs even if the local APIC is not in x2APIC mode (no general-protection fault occurs because the local APIC is not in x2APIC mode).
- **WRMSR.** The instruction’s behavior depends on the value of ECX and the setting of the “virtual-interrupt delivery” and “IPI virtualization” VM-execution controls.

Special processing applies in the following cases: (1) ECX contains 808H (indicating the TPR MSR); (2) ECX contains 80BH (indicating the EOI MSR) and the “virtual-interrupt delivery” VM-execution control is 1; (3) ECX contains 83FH (indicating the self-IPI MSR) and the “virtual-interrupt delivery” VM-execution control is 1; and (4) ECX contains 830H (indicating the ICR MSR) and the “IPI virtualization” VM-execution control is 1.

If special processing applies, no general-protection exception is produced due to the fact that the local APIC is in xAPIC mode. However, WRMSR does perform the normal reserved-bit checking:

- If ECX contains 808H or 83FH, a general-protection fault occurs if either EDX or EAX[31:8] is non-zero.
 - If ECX contains 80BH, a general-protection fault occurs if either EDX or EAX is non-zero.
 - If ECX contains 830H, a general-protection fault occurs if any of bits 31:20, 17:16, or 13 of EAX is non-zero.
- If there is no fault, WRMSR stores EDX:EAX at offset X on the virtual-APIC page, where $X = (ECX \& FFH) \ll 4$. Following this, the processor performs an operation depending on the value of ECX:
- If ECX contains 808H, the processor performs TPR virtualization (see Section 30.1.2).
 - If ECX contains 80BH, the processor performs EOI virtualization (see Section 30.1.4).
 - If ECX contains 83FH, the processor then checks the value of EAX[7:4] and proceeds as follows:

- If the value is non-zero, the logical processor performs self-IPI virtualization with the 8-bit vector in EAX[7:0] (see Section 30.1.5).
 - If the value is zero, the logical processor causes an APIC-write VM exit as if there had been a write access to page offset 3F0H on the APIC-access page (see Section 30.4.3.3).
- If ECX contains 830H, the processor then checks the value of VICR to determine whether the following are all true:
- Bits 19:18 (destination shorthand) are 00B (no shorthand).
 - Bit 15 (trigger mode) is 0 (edge).
 - Bit 12 (unused) is 0.
 - Bit 11 (destination mode) is 0 (physical).
 - Bits 10:8 (delivery mode) are 000B (fixed).

If all of the items above are true, the processor performs IPI virtualization using the 8-bit vector in byte 0 of VICR and the 32-bit APIC ID in VICR[63:32] (see Section 30.1.6). Otherwise, the logical processor causes an APIC-write VM exit (see Section 30.4.3.3).

If special processing does not apply, the instruction operates normally. If the local APIC is in x2APIC mode and ECX indicates a writable APIC register, the value in EDX:EAX is written to that register. If the local APIC is not in x2APIC mode or ECX does not indicate a writable APIC register, a general-protection fault occurs.

30.6 POSTED-INTERRUPT PROCESSING

Posted-interrupt processing is a feature by which a processor processes the virtual interrupts by recording them as pending on the virtual-APIC page.

Posted-interrupt processing is enabled by setting the “process posted interrupts” VM-execution control. The processing is performed in response to the arrival of an interrupt with the **posted-interrupt notification vector**. In response to such an interrupt, the processor processes virtual interrupts recorded in a data structure called a **posted-interrupt descriptor**. The posted-interrupt notification vector and the address of the posted-interrupt descriptor are fields in the VMCS; see Section 25.6.8.

If the “process posted interrupts” VM-execution control is 1, a logical processor uses a 64-byte posted-interrupt descriptor located at the posted-interrupt descriptor address. The posted-interrupt descriptor has the following format:

Table 30-1. Format of Posted-Interrupt Descriptor

Bit Position(s)	Name	Description
255:0	Posted-interrupt requests	One bit for each interrupt vector. There is a posted-interrupt request for a vector if the corresponding bit is 1.
256	Outstanding notification	If this bit is set, there is a notification outstanding for one or more posted interrupts in bits 255:0.
511:257	Reserved for software and other agents	These bits may be used by software and by other agents in the system (e.g., chipset). The processor does not modify these bits.

The notation **PIR** (posted-interrupt requests) refers to the 256 posted-interrupt bits in the posted-interrupt descriptor.

Use of the posted-interrupt descriptor differs from that of other data structures that are referenced by pointers in a VMCS. There is a general requirement that software ensure that each such data structure is modified only when no logical processor with a current VMCS that references it is in VMX non-root operation. That requirement does not apply to the posted-interrupt descriptor. There is a requirement, however, that such modifications be done using locked read-modify-write instructions.

If the “external-interrupt exiting” VM-execution control is 1, any unmasked external interrupt causes a VM exit (see Section 26.2). If the “process posted interrupts” VM-execution control is also 1, this behavior is changed and the processor handles an external interrupt as follows:¹

1. The local APIC is acknowledged; this provides the processor core with an interrupt vector, called here the **physical vector**.
2. If the physical vector equals the posted-interrupt notification vector, the logical processor continues to the next step. Otherwise, a VM exit occurs as it would normally due to an external interrupt; the vector is saved in the VM-exit interruption-information field.
3. The processor clears the outstanding-notification bit in the posted-interrupt descriptor. This is done atomically so as to leave the remainder of the descriptor unmodified (e.g., with a locked AND operation).
4. The processor writes zero to the EOI register in the local APIC; this dismisses the interrupt with the posted-interrupt notification vector from the local APIC.
5. The logical processor performs a logical-OR of PIR into VIRR and clears PIR. No other agent can read or write a PIR bit (or group of bits) between the time it is read (to determine what to OR into VIRR) and when it is cleared.
6. The logical processor sets RVI to be the maximum of the old value of RVI and the highest index of all bits that were set in PIR; if no bit was set in PIR, RVI is left unmodified.
7. The logical processor evaluates pending virtual interrupts as described in Section 30.2.1.

The logical processor performs the steps above in an uninterruptible manner. If step #7 leads to recognition of a virtual interrupt, the processor may deliver that interrupt immediately.

Steps #1 to #7 above occur when the interrupt controller delivers an unmasked external interrupt to the CPU core. The following items consider certain cases of interrupt delivery:

- Interrupt delivery can occur between iterations of a REP-prefixed instruction (after at least one iteration has completed but before all iterations have completed). If this occurs, the following items characterize processor state after posted-interrupt processing completes and before guest execution resumes:
 - RIP references the REP-prefixed instruction;
 - RCX, RSI, and RDI are updated to reflect the iterations completed; and
 - RFLAGS.RF = 1.
- Interrupt delivery can occur when the logical processor is in the active, HLT, or MWAIT states. If the logical processor had been in the active or MWAIT state before the arrival of the interrupt, it is in the active state following completion of step #7; if it had been in the HLT state, it returns to the HLT state after step #7 (if a pending virtual interrupt was recognized, the logical processor may immediately wake from the HLT state).
- Interrupt delivery can occur while the logical processor is in enclave mode. If the logical processor had been in enclave mode before the arrival of the interrupt, an Asynchronous Enclave Exit (AEX) may occur before the steps #1 to #7 (see Chapter 37, “Enclave Exiting Events”). If no AEX occurs before step #1 and a VM exit occurs at step #2, an AEX occurs before the VM exit is delivered.

30.7 VIRTUALIZING SENDUIPI

The user-interrupt feature includes the SENDUIPI instruction that software operating with CPL = 3 can use to send user interrupts to another software thread (“user IPIs”). The SENDUIPI instruction has the following high-level operation:

- read selected entry from user-interrupt target table;
- use address in entry to read the referenced user posted-interrupt descriptor (UPID);
- update certain fields in UPID;
- if necessary, send ordinary IPI indicated in UPID’s notification information;

1. VM entry ensures that the “process posted interrupts” VM-execution control is 1 only if the “external-interrupt exiting” VM-execution control is also 1. See Section 27.2.1.1.

The last step uses two fields in the UPID: an 8-bit notification vector (UPID.NV) and a 32-bit notification destination (an APIC ID, UPID.NDST). Outside of VMX non-root operation, the processor implements the last step as follows:

- If the local APIC is in xAPIC mode, it writes UPID.NDST[15:8] to ICR_HI[31:24] (offset 310H from IA32_APIC_BASE) and then writes UPID.NV to ICR_LO (offset 300H).
- If the local APIC is in x2APIC mode, it performs the control-register write that would be done by an execution of WRMSR with ECX = 310H (ICR), EAX = UPID.NV, and EDX = UPID.NDST.

In VMX non-root operation, implementation of the step depends on the settings of the “use TPR shadow,” “virtualize APIC accesses,” and “IPI virtualization” VM-execution controls:¹

1. If the “use TPR shadow” VM-execution control is 0, the behavior is not modified: the logical processor sends the specified IPI by writing to the local APIC’s ICR as specified above (based on the current mode of the local APIC).
2. If the “use TPR shadow” VM-execution control is 1 and the “virtualize APIC accesses” VM-execution control is 0, the logical processor virtualizes the sending of an x2APIC-mode IPI with the following steps:
 - a. The 64-bit value Z is written to offset 300H on the virtual-APIC page (VICR), where Z[7:0] = UPID.NV (the 8-bit virtual vector), Z[63:32] = UPID.NDST (the 32-bit virtual APIC ID) and Z[31:8] = 000000H (indicating a physically addressed fixed-mode IPI).
 - b. If the “IPI virtualization” VM-execution control is 1, IPI virtualization (Section 30.1.6) is performed using the vector UPID.NV and the 32-bit virtual APIC ID UPID.NDST.
3. If the “use TPR shadow” and “virtualize APIC accesses” VM-execution controls are both 1, the logical processor virtualizes the sending of an xAPIC-mode IPI by performing the following steps:
 - a. The 32-bit value X is written to offset 310H on the virtual-APIC page (VICR_HI), where X[31:24] = UPID.NDST[15:8] (the 8-bit virtual APIC ID) and X[23:0] = 000000H.²
 - b. The 32-bit value Y is written to offset 300H on the virtual-APIC page (VICR_LO), where Y[7:0] = UPID.NV (the 8-bit virtual vector) and Y[31:8] = 000000H (indicating a physically addressed fixed-mode IPI).
 - c. If the “IPI virtualization” VM-execution control is 1, IPI virtualization is performed using the vector UPID.NV and the APIC ID UPID.NDST[15:8]. IPI virtualization will use only the 8-bit APIC ID from bits 15:8 of the UPID’s destination field (the 8-bit value written earlier to bits 31:24 of VICR_HI).
4. If the “use TPR shadow” VM-execution control is 1 and the “IPI virtualization” VM-execution control is 0, an APIC-write VM exit occurs as if there had been a write access to page offset 300H on the APIC-access page (see Section 30.4.3.3).

1. The setting of the “virtualize x2APIC mode” VM-execution control does not affect this operation.

2. For xAPIC mode (which is virtualized if the “virtualize APIC accesses” VM-execution control is 1), the destination APIC ID is in byte 1 (not byte 0) of the UPID’s 4-byte NDST field.

31.1 OVERVIEW

This chapter describes the virtual-machine extensions (VMX) for the Intel 64 and IA-32 architectures. VMX is intended to support virtualization of processor hardware and a system software layer acting as a host to multiple guest software environments. The virtual-machine extensions (VMX) includes five instructions that manage the virtual-machine control structure (VMCS), four instructions that manage VMX operation, two TLB-management instructions, and two instructions for use by guest software. Additional details of VMX are described in Chapter 24 through Chapter 30.

The behavior of the VMCS-maintenance instructions is summarized below:

- **VMPTTRLD** — This instruction takes a single 64-bit source operand that is in memory. It makes the referenced VMCS active and current, loading the current-VMCS pointer with this operand and establishes the current VMCS based on the contents of VMCS-data area in the referenced VMCS region. Because this makes the referenced VMCS active, a logical processor may start maintaining on the processor some of the VMCS data for the VMCS.
- **VMPTTRST** — This instruction takes a single 64-bit destination operand that is in memory. The current-VMCS pointer is stored into the destination operand.
- **VMPCLEAR** — This instruction takes a single 64-bit operand that is in memory. The instruction sets the launch state of the VMCS referenced by the operand to “clear”, renders that VMCS inactive, and ensures that data for the VMCS have been written to the VMCS-data area in the referenced VMCS region. If the operand is the same as the current-VMCS pointer, that pointer is made invalid.
- **VMPCREAD** — This instruction reads a component from a VMCS (the encoding of that field is given in a register operand) and stores it into a destination operand that may be a register or in memory.
- **VMPCWRITE** — This instruction writes a component to a VMCS (the encoding of that field is given in a register operand) from a source operand that may be a register or in memory.

The behavior of the VMX management instructions is summarized below:

- **VMPLAUNCH** — This instruction launches a virtual machine managed by the VMCS. A VM entry occurs, transferring control to the VM.
- **VMRESUME** — This instruction resumes a virtual machine managed by the VMCS. A VM entry occurs, transferring control to the VM.
- **VMXOFF** — This instruction causes the processor to leave VMX operation.
- **VMXON** — This instruction takes a single 64-bit source operand that is in memory. It causes a logical processor to enter VMX root operation and to use the memory referenced by the operand to support VMX operation.

The behavior of the VMX-specific TLB-management instructions is summarized below:

- **INVEPT** — This instruction invalidates entries in the TLBs and paging-structure caches that were derived from extended page tables (EPT).
- **INVVPID** — This instruction invalidates entries in the TLBs and paging-structure caches based on a Virtual-Processor Identifier (VPID).

None of the instructions above can be executed in compatibility mode; they generate invalid-opcode exceptions if executed in compatibility mode.

The behavior of the guest-available instructions is summarized below:

- **VMCALL** — This instruction allows software in VMX non-root operation to call the VMM for service. A VM exit occurs, transferring control to the VMM.
- **VMFUNC** — This instruction allows software in VMX non-root operation to invoke a VM function (processor functionality enabled and configured by software in VMX root operation) without a VM exit.

31.2 CONVENTIONS

The operation sections for the VMX instructions in Section 31.3 use the pseudo-function VMExit, which indicates that the logical processor performs a VM exit.

The operation sections also use the pseudo-functions VMsucceed, VMfail, VMfailInvalid, and VMfailValid. These pseudo-functions signal instruction success or failure by setting or clearing bits in RFLAGS and, in some cases, by writing the VM-instruction error field. The following pseudocode fragments detail these functions:

VMsucceed:

```
CF := 0;
PF := 0;
AF := 0;
ZF := 0;
SF := 0;
OF := 0;
```

VMfail(ErrorNumber):

```
IF VMCS pointer is valid
  THEN VMfailValid(ErrorNumber);
  ELSE VMfailInvalid;
FI;
```

VMfailInvalid:

```
CF := 1;
PF := 0;
AF := 0;
ZF := 0;
SF := 0;
OF := 0;
```

VMfailValid(ErrorNumber)// executed only if there is a current VMCS

```
CF := 0;
PF := 0;
AF := 0;
ZF := 1;
SF := 0;
OF := 0;
Set the VM-instruction error field to ErrorNumber;
```

The different VM-instruction error numbers are enumerated in Section 31.4, "VM Instruction Error Numbers."

31.3 VMX INSTRUCTIONS

This section provides detailed descriptions of the VMX instructions.

INVEPT— Invalidate Translations Derived from EPT

Opcode/ Instruction	Op/En	Description
66 0F 38 80 INVEPT r64, m128	RM	Invalidates EPT-derived entries in the TLBs and paging-structure caches (in 64-bit mode).
66 0F 38 80 INVEPT r32, m128	RM	Invalidates EPT-derived entries in the TLBs and paging-structure caches (outside 64-bit mode).

Instruction Operand Encoding

Op/En	Operand 1	Operand 2	Operand 3	Operand 4
RM	ModRM:reg (r)	ModRM:r/m (r)	NA	NA

Description

Invalidates mappings in the translation lookaside buffers (TLBs) and paging-structure caches that were derived from extended page tables (EPT). (See Chapter 29, “VMX Support for Address Translation.”) Invalidation is based on the **INVEPT type** specified in the register operand and the **INVEPT descriptor** specified in the memory operand.

Outside IA-32e mode, the register operand is always 32 bits, regardless of the value of CS.D; in 64-bit mode, the register operand has 64 bits (the instruction cannot be executed in compatibility mode).

The INVEPT types supported by a logical processors are reported in the IA32_VMX_EPT_VPID_CAP MSR (see Appendix A, “VMX Capability Reporting Facility”). There are two INVEPT types currently defined:

- Single-context invalidation. If the INVEPT type is 1, the logical processor invalidates all mappings associated with bits 51:12 of the EPT pointer (EPTP) specified in the INVEPT descriptor. It may invalidate other mappings as well.
- Global invalidation: If the INVEPT type is 2, the logical processor invalidates mappings associated with all EPTPs.

If an unsupported INVEPT type is specified, the instruction fails.

INVEPT invalidates all the specified mappings for the indicated EPTP(s) regardless of the VPID and PCID values with which those mappings may be associated.

The INVEPT descriptor comprises 128 bits and contains a 64-bit EPTP value in bits 63:0 (see Figure 31-1).

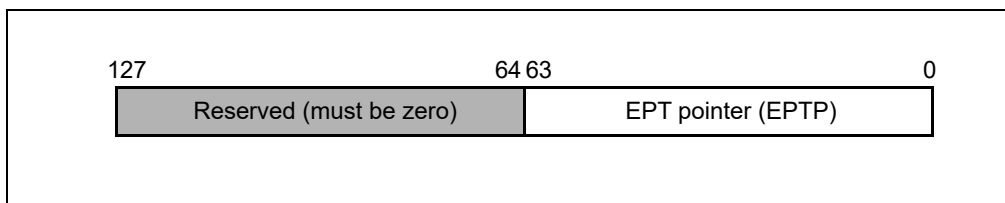

Figure 31-1. INVEPT Descriptor

Operation

```

IF (not in VMX operation) or (CR0.PE = 0) or (RFLAGS.VM = 1) or (IA32_EFER.LMA = 1 and CS.L = 0)
  THEN #UD;
ELSIF in VMX non-root operation
  THEN VM exit;
ELSIF CPL > 0
  THEN #GP(0);
ELSE

```

```

INVEPT_TYPE := value of register operand;
IF IA32_VMX_EPT_VPID_CAP MSR indicates that processor does not support INVEPT_TYPE
  THEN VMfail(Invalid operand to INVEPT/INVVPID);
  ELSE // INVEPT_TYPE must be 1 or 2
    INVEPT_DESC := value of memory operand;
    EPTP := INVEPT_DESC[63:0];
    CASE INVEPT_TYPE OF
      1: // single-context invalidation
        IF VM entry with the "enable EPT" VM execution control set to 1
          would fail due to the EPTP value
          THEN VMfail(Invalid operand to INVEPT/INVVPID);
          ELSE
            Invalidate mappings associated with EPTP[51:12];
            VMSucceed;
        FI;
      BREAK;
      2: // global invalidation
        Invalidate mappings associated with all EPTPs;
        VMSucceed;
        BREAK;
    ESAC;
  FI;
FI;

```

Flags Affected

See the operation section and Section 31.2.

Protected Mode Exceptions

#GP(0)	<p>If the current privilege level is not 0.</p> <p>If the memory operand effective address is outside the CS, DS, ES, FS, or GS segment limit.</p> <p>If the DS, ES, FS, or GS register contains an unusable segment.</p> <p>If the source operand is located in an execute-only code segment.</p>
#PF(fault-code)	If a page fault occurs in accessing the memory operand.
#SS(0)	<p>If the memory operand effective address is outside the SS segment limit.</p> <p>If the SS register contains an unusable segment.</p>
#UD	<p>If not in VMX operation.</p> <p>If the logical processor does not support EPT (IA32_VMX_PROCBASED_CTL2[33]=0).</p> <p>If the logical processor supports EPT (IA32_VMX_PROCBASED_CTL2[33]=1) but does not support the INVEPT instruction (IA32_VMX_EPT_VPID_CAP[20]=0).</p>

Real-Address Mode Exceptions

#UD	The INVEPT instruction is not recognized in real-address mode.
-----	--

Virtual-8086 Mode Exceptions

#UD	The INVEPT instruction is not recognized in virtual-8086 mode.
-----	--

Compatibility Mode Exceptions

#UD	The INVEPT instruction is not recognized in compatibility mode.
-----	---

64-Bit Mode Exceptions

#GP(0)	If the current privilege level is not 0. If the memory operand is in the CS, DS, ES, FS, or GS segments and the memory address is in a non-canonical form.
#PF(fault-code)	If a page fault occurs in accessing the memory operand.
#SS(0)	If the memory operand is in the SS segment and the memory address is in a non-canonical form.
#UD	If not in VMX operation. If the logical processor does not support EPT (IA32_VMX_PROCBASED_CTL2[33]=0). If the logical processor supports EPT (IA32_VMX_PROCBASED_CTL2[33]=1) but does not support the INVEPT instruction (IA32_VMX_EPT_VPID_CAP[20]=0).

INVVPID— Invalidate Translations Based on VPID

Opcode/ Instruction	Op/En	Description
66 0F 38 81 INVVPID r64, m128	RM	Invalidates entries in the TLBs and paging-structure caches based on VPID (in 64-bit mode).
66 0F 38 81 INVVPID r32, m128	RM	Invalidates entries in the TLBs and paging-structure caches based on VPID (outside 64-bit mode).

Instruction Operand Encoding

Op/En	Operand 1	Operand 2	Operand 3	Operand 4
RM	ModRM:reg (r)	ModRM:r/m (r)	NA	NA

Description

Invalidates mappings in the translation lookaside buffers (TLBs) and paging-structure caches based on **virtual-processor identifier** (VPID). (See Chapter 29, “VMX Support for Address Translation.”) Invalidation is based on the **INVVPID type** specified in the register operand and the **INVVPID descriptor** specified in the memory operand.

Outside IA-32e mode, the register operand is always 32 bits, regardless of the value of CS.D; in 64-bit mode, the register operand has 64 bits (the instruction cannot be executed in compatibility mode).

The INVVPID types supported by a logical processors are reported in the IA32_VMX_EPT_VPID_CAP MSR (see Appendix A, “VMX Capability Reporting Facility”). There are four INVVPID types currently defined:

- Individual-address invalidation: If the INVVPID type is 0, the logical processor invalidates mappings for the linear address and VPID specified in the INVVPID descriptor. In some cases, it may invalidate mappings for other linear addresses (or other VPIDs) as well.
- Single-context invalidation: If the INVVPID type is 1, the logical processor invalidates all mappings tagged with the VPID specified in the INVVPID descriptor. In some cases, it may invalidate mappings for other VPIDs as well.
- All-contexts invalidation: If the INVVPID type is 2, the logical processor invalidates all mappings tagged with all VPIDs except VPID 0000H. In some cases, it may invalidate translations with VPID 0000H as well.
- Single-context invalidation, retaining global translations: If the INVVPID type is 3, the logical processor invalidates all mappings tagged with the VPID specified in the INVVPID descriptor except global translations. In some cases, it may invalidate global translations (and mappings with other VPIDs) as well. See the “Caching Translation Information” section in Chapter 4 of the Intel® 64 and IA-32 Architectures Software Developer’s Manual, Volume 3A, for information about global translations.

If an unsupported INVVPID type is specified, the instruction fails.

INVVPID invalidates all the specified mappings for the indicated VPID(s) regardless of the EPTP and PCID values with which those mappings may be associated.

The INVVPID descriptor comprises 128 bits and consists of a VPID and a linear address as shown in Figure 31-2.

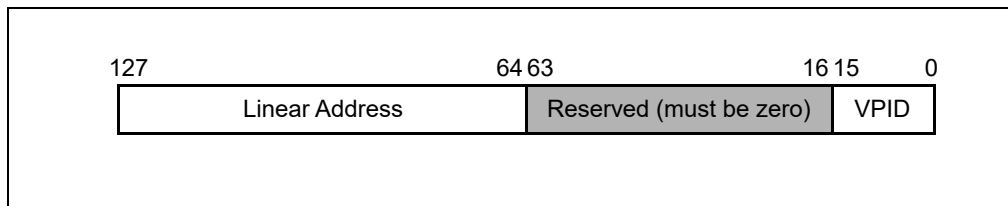

Figure 31-2. INVVPID Descriptor

Operation

```

IF (not in VMX operation) or (CRO.PE = 0) or (RFLAGS.VM = 1) or (IA32_EFER.LMA = 1 and CS.L = 0)
    THEN #UD;
ELSIF in VMX non-root operation
    THEN VM exit;
ELSIF CPL > 0
    THEN #GP(0);
ELSE
    INVVPID_TYPE := value of register operand;
    IF IA32_VMX_EPT_VPID_CAP MSR indicates that processor does not support
    INVVPID_TYPE
        THEN VMfail(Invalid operand to INVEPT/INVVPID);
    ELSE // INVVPID_TYPE must be in the range 0–3
        INVVPID_DESC := value of memory operand;
        IF INVVPID_DESC[63:16] ≠ 0
            THEN VMfail(Invalid operand to INVEPT/INVVPID);
        ELSE
            CASE INVVPID_TYPE OF
                0: // individual-address invalidation
                    VPID := INVVPID_DESC[15:0];
                    IF VPID = 0
                        THEN VMfail(Invalid operand to INVEPT/INVVPID);
                    ELSE
                        GL_ADDR := INVVPID_DESC[127:64];
                        IF (GL_ADDR is not in a canonical form)
                            THEN
                                VMfail(Invalid operand to INVEPT/INVVPID);
                            ELSE
                                Invalidate mappings for GL_ADDR tagged with VPID;
                                VMSucceed;
                        FI;
                    FI;
                    BREAK;
                1: // single-context invalidation
                    VPID := INVVPID_DESC[15:0];
                    IF VPID = 0
                        THEN VMfail(Invalid operand to INVEPT/INVVPID);
                    ELSE
                        Invalidate all mappings tagged with VPID;
                        VMSucceed;
                    FI;
                    BREAK;
                2: // all-context invalidation
                    Invalidate all mappings tagged with all non-zero VPIDs;
                    VMSucceed;
                    BREAK;
                3: // single-context invalidation retaining globals
                    VPID := INVVPID_DESC[15:0];
                    IF VPID = 0
                        THEN VMfail(Invalid operand to INVEPT/INVVPID);
                    ELSE
                        Invalidate all mappings tagged with VPID except global translations;
                        VMSucceed;
            END CASE;
        END IF;
    END IF;
END IF;

```

FI;
BREAK;
ESAC;
FI;
FI;
FI;

Flags Affected

See the operation section and Section 31.2.

Protected Mode Exceptions

- #GP(0) If the current privilege level is not 0.
 If the memory operand effective address is outside the CS, DS, ES, FS, or GS segment limit.
 If the DS, ES, FS, or GS register contains an unusable segment.
 If the source operand is located in an execute-only code segment.
- #PF(fault-code) If a page fault occurs in accessing the memory operand.
- #SS(0) If the memory operand effective address is outside the SS segment limit.
 If the SS register contains an unusable segment.
- #UD If not in VMX operation.
 If the logical processor does not support VPIDs (IA32_VMX_PROCBASED_CTL2[37]=0).
 If the logical processor supports VPIDs (IA32_VMX_PROCBASED_CTL2[37]=1) but does not support the INVVPID instruction (IA32_VMX_EPT_VPID_CAP[32]=0).

Real-Address Mode Exceptions

- #UD The INVVPID instruction is not recognized in real-address mode.

Virtual-8086 Mode Exceptions

- #UD The INVVPID instruction is not recognized in virtual-8086 mode.

Compatibility Mode Exceptions

- #UD The INVVPID instruction is not recognized in compatibility mode.

64-Bit Mode Exceptions

- #GP(0) If the current privilege level is not 0.
 If the memory operand is in the CS, DS, ES, FS, or GS segments and the memory address is in a non-canonical form.
- #PF(fault-code) If a page fault occurs in accessing the memory operand.
- #SS(0) If the memory destination operand is in the SS segment and the memory address is in a non-canonical form.
- #UD If not in VMX operation.
 If the logical processor does not support VPIDs (IA32_VMX_PROCBASED_CTL2[37]=0).
 If the logical processor supports VPIDs (IA32_VMX_PROCBASED_CTL2[37]=1) but does not support the INVVPID instruction (IA32_VMX_EPT_VPID_CAP[32]=0).

VMCALL—Call to VM Monitor

Opcode/ Instruction	Op/En	Description
OF 01 C1 VMCALL	Z0	Call to VM monitor by causing VM exit.

Instruction Operand Encoding

Op/En	Operand 1	Operand 2	Operand 3	Operand 4
Z0	NA	NA	NA	NA

Description

This instruction allows guest software can make a call for service into an underlying VM monitor. The details of the programming interface for such calls are VMM-specific; this instruction does nothing more than cause a VM exit, registering the appropriate exit reason.

Use of this instruction in VMX root operation invokes an SMM monitor (see Section 32.15.2). This invocation will activate the dual-monitor treatment of system-management interrupts (SMIs) and system-management mode (SMM) if it is not already active (see Section 32.15.6).

Operation

```

IF not in VMX operation
    THEN #UD;
ELSIF in VMX non-root operation
    THEN VM exit;
ELSIF (RFLAGS.VM = 1) or (IA32_EFER.LMA = 1 and CS.L = 0)
    THEN #UD;
ELSIF CPL > 0
    THEN #GP(0);
ELSIF in SMM or the logical processor does not support the dual-monitor treatment of SMIs and SMM or the valid bit in the
IA32_SMM_MONITOR_CTL MSR is clear
    THEN VMfail (VMCALL executed in VMX root operation);
ELSIF dual-monitor treatment of SMIs and SMM is active
    THEN perform an SMM VM exit (see Section 32.15.2);
ELSIF current-VMCS pointer is not valid
    THEN VMfailInvalid;
ELSIF launch state of current VMCS is not clear
    THEN VMfailValid(VMCALL with non-clear VMCS);
ELSIF VM-exit control fields are not valid (see Section 32.15.6.1)
    THEN VMfailValid (VMCALL with invalid VM-exit control fields);
ELSE
    enter SMM;
    read revision identifier in MSEG;
    IF revision identifier does not match that supported by processor
        THEN
            leave SMM;
            VMfailValid(VMCALL with incorrect MSEG revision identifier);
        ELSE
            read SMM-monitor features field in MSEG (see Section 32.15.6.1);
            IF features field is invalid
                THEN
                    leave SMM;

```

VMfailValid(VMCALL with invalid SMM-monitor features);
ELSE activate dual-monitor treatment of SMIs and SMM (see Section 32.15.6);
FI;
FI;
FI;

Flags Affected

See the operation section and Section 31.2.

Protected Mode Exceptions

- #GP(0) If the current privilege level is not 0 and the logical processor is in VMX root operation.
- #UD If executed outside VMX operation.

Real-Address Mode Exceptions

- #UD If executed outside VMX operation.

Virtual-8086 Mode Exceptions

- #UD If executed outside VMX non-root operation.

Compatibility Mode Exceptions

- #UD If executed outside VMX non-root operation.

64-Bit Mode Exceptions

- #UD If executed outside VMX operation.

VMCLEAR—Clear Virtual-Machine Control Structure

Opcode/ Instruction	Op/En	Description
66 0F C7 /6 VMCLEAR m64	M	Copy VMCS data to VMCS region in memory.

Instruction Operand Encoding

Op/En	Operand 1	Operand 2	Operand 3	Operand 4
M	ModRM:r/m (r)	NA	NA	NA

Description

This instruction applies to the VMCS whose VMCS region resides at the physical address contained in the instruction operand. The instruction ensures that VMCS data for that VMCS (some of these data may be currently maintained on the processor) are copied to the VMCS region in memory. It also initializes parts of the VMCS region (for example, it sets the launch state of that VMCS to clear). See Chapter 25, “Virtual Machine Control Structures.”

The operand of this instruction is always 64 bits and is always in memory. If the operand is the current-VMCS pointer, then that pointer is made invalid (set to FFFFFFFF_FFFFFFFFH).

Note that the VMCLEAR instruction might not explicitly write any VMCS data to memory; the data may be already resident in memory before the VMCLEAR is executed.

Operation

```

IF (register operand) or (not in VMX operation) or (CR0.PE = 0) or (RFLAGS.VM = 1) or (IA32_EFER.LMA = 1 and CS.L = 0)
  THEN #UD;
ELSIF in VMX non-root operation
  THEN VM exit;
ELSIF CPL > 0
  THEN #GP(0);
ELSE
  addr := contents of 64-bit in-memory operand;
  IF addr is not 4KB-aligned OR
  addr sets any bits beyond the physical-address width1
    THEN VMfail(VMCLEAR with invalid physical address);
  ELSIF addr = VMXON pointer
    THEN VMfail(VMCLEAR with VMXON pointer);
  ELSE
    ensure that data for VMCS referenced by the operand is in memory;
    initialize implementation-specific data in VMCS region;
    launch state of VMCS referenced by the operand := “clear”
    IF operand addr = current-VMCS pointer
      THEN current-VMCS pointer := FFFFFFFF_FFFFFFFFH;
    FI;
    VMsucceed;
  FI;
FI;

```

Flags Affected

See the operation section and Section 31.2.

1. If IA32_VMX_BASIC[48] is read as 1, VMfail occurs if addr sets any bits in the range 63:32; see Appendix A.1.

Protected Mode Exceptions

#GP(0)	<p>If the current privilege level is not 0.</p> <p>If the memory operand effective address is outside the CS, DS, ES, FS, or GS segment limit.</p> <p>If the DS, ES, FS, or GS register contains an unusable segment.</p> <p>If the operand is located in an execute-only code segment.</p>
#PF(fault-code)	If a page fault occurs in accessing the memory operand.
#SS(0)	<p>If the memory operand effective address is outside the SS segment limit.</p> <p>If the SS register contains an unusable segment.</p>
#UD	<p>If operand is a register.</p> <p>If not in VMX operation.</p>

Real-Address Mode Exceptions

#UD	The VMCLEAR instruction is not recognized in real-address mode.
-----	---

Virtual-8086 Mode Exceptions

#UD	The VMCLEAR instruction is not recognized in virtual-8086 mode.
-----	---

Compatibility Mode Exceptions

#UD	The VMCLEAR instruction is not recognized in compatibility mode.
-----	--

64-Bit Mode Exceptions

#GP(0)	<p>If the current privilege level is not 0.</p> <p>If the source operand is in the CS, DS, ES, FS, or GS segments and the memory address is in a non-canonical form.</p>
#PF(fault-code)	If a page fault occurs in accessing the memory operand.
#SS(0)	If the source operand is in the SS segment and the memory address is in a non-canonical form.
#UD	<p>If operand is a register.</p> <p>If not in VMX operation.</p>

VMFUNC—Invoke VM function

Opcode/ Instruction	Op/En	Description
NP 0F 01 D4 VMFUNC	Z0	Invoke VM function specified in EAX.

Instruction Operand Encoding

Op/En	Operand 1	Operand 2	Operand 3	Operand 4
Z0	NA	NA	NA	NA

Description

This instruction allows software in VMX non-root operation to invoke a VM function, which is processor functionality enabled and configured by software in VMX root operation. The value of EAX selects the specific VM function being invoked.

The behavior of each VM function (including any additional fault checking) is specified in Section 26.5.6, “VM Functions.”

Operation

Perform functionality of the VM function specified in EAX;

Flags Affected

Depends on the VM function specified in EAX. See Section 26.5.6, “VM Functions.”

Protected Mode Exceptions (not including those defined by specific VM functions)

#UD If executed outside VMX non-root operation.
If “enable VM functions” VM-execution control is 0.
If $EAX \geq 64$.

Real-Address Mode Exceptions

Same exceptions as in protected mode.

Virtual-8086 Exceptions

Same exceptions as in protected mode.

Compatibility Mode Exceptions

Same exceptions as in protected mode.

64-Bit Mode Exceptions

Same exceptions as in protected mode.

VMLAUNCH/VMRESUME—Launch/Resume Virtual Machine

Opcode/ Instruction	Op/En	Description
OF 01 C2 VMLAUNCH	Z0	Launch virtual machine managed by current VMCS.
OF 01 C3 VMRESUME	Z0	Resume virtual machine managed by current VMCS.

Instruction Operand Encoding

Op/En	Operand 1	Operand 2	Operand 3	Operand 4
Z0	NA	NA	NA	NA

Description

Effects a VM entry managed by the current VMCS.

- VMLAUNCH fails if the launch state of current VMCS is not “clear”. If the instruction is successful, it sets the launch state to “launched.”
- VMRESUME fails if the launch state of the current VMCS is not “launched.”

If VM entry is attempted, the logical processor performs a series of consistency checks as detailed in Chapter 27, “VM Entries.” Failure to pass checks on the VMX controls or on the host-state area passes control to the instruction following the VMLAUNCH or VMRESUME instruction. If these pass but checks on the guest-state area fail, the logical processor loads state from the host-state area of the VMCS, passing control to the instruction referenced by the RIP field in the host-state area.

VM entry is not allowed when events are blocked by MOV SS or POP SS. Neither VMLAUNCH nor VMRESUME should be used immediately after either MOV to SS or POP to SS.

Operation

```

IF (not in VMX operation) or (CR0.PE = 0) or (RFLAGS.VM = 1) or (IA32_EFER.LMA = 1 and CS.L = 0)
    THEN #UD;
ELSIF in VMX non-root operation
    THEN VMexit;
ELSIF CPL > 0
    THEN #GP(0);
ELSIF current-VMCS pointer is not valid
    THEN VMfailInvalid;
ELSIF events are being blocked by MOV SS
    THEN VMfailValid(VM entry with events blocked by MOV SS);
ELSIF (VMLAUNCH and launch state of current VMCS is not “clear”)
    THEN VMfailValid(VMLAUNCH with non-clear VMCS);
ELSIF (VMRESUME and launch state of current VMCS is not “launched”)
    THEN VMfailValid(VMRESUME with non-launched VMCS);
ELSE
    Check settings of VMX controls and host-state area;
    IF invalid settings
        THEN VMfailValid(VM entry with invalid VMX-control field(s)) or
            VMfailValid(VM entry with invalid host-state field(s)) or
            VMfailValid(VM entry with invalid executive-VMCS pointer)) or
            VMfailValid(VM entry with non-launched executive VMCS) or
            VMfailValid(VM entry with executive-VMCS pointer not VMXON pointer) or
    
```



```

    VMfailValid(VM entry with invalid VM-execution control fields in executive
    VMCS)
    as appropriate;
ELSE
    Attempt to load guest state and PDPTRs as appropriate;
    clear address-range monitoring;
    IF failure in checking guest state or PDPTRs
        THEN VM entry fails (see Section 27.8);
    ELSE
        Attempt to load MSRs from VM-entry MSR-load area;
        IF failure
            THEN VM entry fails
            (see Section 27.8);
            ELSE
                IF VMLAUNCH
                    THEN launch state of VMCS := "launched";
                FI;
                IF in SMM and "entry to SMM" VM-entry control is 0
                    THEN
                        IF "deactivate dual-monitor treatment" VM-entry
                        control is 0
                            THEN SMM-transfer VMCS pointer :=
                            current-VMCS pointer;
                        FI;
                        IF executive-VMCS pointer is VMXON pointer
                            THEN current-VMCS pointer :=
                            VMCS-link pointer;
                            ELSE current-VMCS pointer :=
                            executive-VMCS pointer;
                        FI;
                        leave SMM;
                    FI;
                VM entry succeeds;
            FI;
        FI;
    FI;
FI;

```

Further details of the operation of the VM-entry appear in Chapter 27.

Flags Affected

See the operation section and Section 31.2.

Protected Mode Exceptions

#GP(0) If the current privilege level is not 0.
#UD If executed outside VMX operation.

Real-Address Mode Exceptions

#UD The VMLAUNCH and VMRESUME instructions are not recognized in real-address mode.

Virtual-8086 Mode Exceptions

#UD The VMLAUNCH and VMRESUME instructions are not recognized in virtual-8086 mode.

Compatibility Mode Exceptions

#UD The VMLAUNCH and VMRESUME instructions are not recognized in compatibility mode.

64-Bit Mode Exceptions

#GP(0) If the current privilege level is not 0.

#UD If executed outside VMX operation.

VMPTRLD—Load Pointer to Virtual-Machine Control Structure

Opcode/ Instruction	Op/En	Description
NP OF C7 /6 VMPTRLD m64	M	Loads the current VMCS pointer from memory.

Instruction Operand Encoding

Op/En	Operand 1	Operand 2	Operand 3	Operand 4
M	ModRM:r/m (r)	NA	NA	NA

Description

Marks the current-VMCS pointer valid and loads it with the physical address in the instruction operand. The instruction fails if its operand is not properly aligned, sets unsupported physical-address bits, or is equal to the VMXON pointer. In addition, the instruction fails if the 32 bits in memory referenced by the operand do not match the VMCS revision identifier supported by this processor.¹

The operand of this instruction is always 64 bits and is always in memory.

Operation

```

IF (register operand) or (not in VMX operation) or (CR0.PE = 0) or (RFLAGS.VM = 1) or (IA32_EFER.LMA = 1 and CS.L = 0)
  THEN #UD;
ELSIF in VMX non-root operation
  THEN VMexit;
ELSIF CPL > 0
  THEN #GP(0);
ELSE
  addr := contents of 64-bit in-memory source operand;
  IF addr is not 4KB-aligned OR
  addr sets any bits beyond the physical-address width2
    THEN VMfail(VMPTRLD with invalid physical address);
  ELSIF addr = VMXON pointer
    THEN VMfail(VMPTRLD with VMXON pointer);
  ELSE
    rev := 32 bits located at physical address addr;
    IF rev[30:0] ≠ VMCS revision identifier supported by processor OR
    rev[31] = 1 AND processor does not support 1-setting of "VMCS shadowing"
      THEN VMfail(VMPTRLD with incorrect VMCS revision identifier);
    ELSE
      current-VMCS pointer := addr;
      VMSucceed;
    FI;
  FI;
FI;

```

Flags Affected

See the operation section and Section 31.2.

1. Software should consult the VMX capability MSR VMX_BASIC to discover the VMCS revision identifier supported by this processor (see Appendix A, "VMX Capability Reporting Facility").
2. If IA32_VMX_BASIC[48] is read as 1, VMfail occurs if addr sets any bits in the range 63:32; see Appendix A.1.

Protected Mode Exceptions

#GP(0)	<p>If the current privilege level is not 0.</p> <p>If the memory source operand effective address is outside the CS, DS, ES, FS, or GS segment limit.</p> <p>If the DS, ES, FS, or GS register contains an unusable segment.</p> <p>If the source operand is located in an execute-only code segment.</p>
#PF(fault-code)	If a page fault occurs in accessing the memory source operand.
#SS(0)	<p>If the memory source operand effective address is outside the SS segment limit.</p> <p>If the SS register contains an unusable segment.</p>
#UD	<p>If operand is a register.</p> <p>If not in VMX operation.</p>

Real-Address Mode Exceptions

#UD	The VMPTRLD instruction is not recognized in real-address mode.
-----	---

Virtual-8086 Mode Exceptions

#UD	The VMPTRLD instruction is not recognized in virtual-8086 mode.
-----	---

Compatibility Mode Exceptions

#UD	The VMPTRLD instruction is not recognized in compatibility mode.
-----	--

64-Bit Mode Exceptions

#GP(0)	<p>If the current privilege level is not 0.</p> <p>If the source operand is in the CS, DS, ES, FS, or GS segments and the memory address is in a non-canonical form.</p>
#PF(fault-code)	If a page fault occurs in accessing the memory source operand.
#SS(0)	If the source operand is in the SS segment and the memory address is in a non-canonical form.
#UD	<p>If operand is a register.</p> <p>If not in VMX operation.</p>

VMPTRST—Store Pointer to Virtual-Machine Control Structure

Opcode/ Instruction	Op/En	Description
NP OF C7 77 VMPTRST m64	M	Stores the current VMCS pointer into memory.

Instruction Operand Encoding

Op/En	Operand 1	Operand 2	Operand 3	Operand 4
M	ModRM:r/m (w)	NA	NA	NA

Description

Stores the current-VMCS pointer into a specified memory address. The operand of this instruction is always 64 bits and is always in memory.

Operation

```
IF (register operand) or (not in VMX operation) or (CR0.PE = 0) or (RFLAGS.VM = 1) or (IA32_EFER.LMA = 1 and CS.L = 0)
  THEN #UD;
ELSIF in VMX non-root operation
  THEN VMexit;
ELSIF CPL > 0
  THEN #GP(0);
ELSE
  64-bit in-memory destination operand := current-VMCS pointer;
  VMSucceed;
FI;
```

Flags Affected

See the operation section and Section 31.2.

Protected Mode Exceptions

#GP(0)	If the current privilege level is not 0. If the memory destination operand effective address is outside the CS, DS, ES, FS, or GS segment limit. If the DS, ES, FS, or GS register contains an unusable segment.
#PF(fault-code)	If the destination operand is located in a read-only data segment or any code segment.
#SS(0)	If a page fault occurs in accessing the memory destination operand. If the memory destination operand effective address is outside the SS segment limit. If the SS register contains an unusable segment.
#UD	If operand is a register. If not in VMX operation.

Real-Address Mode Exceptions

#UD	The VMPTRST instruction is not recognized in real-address mode.
-----	---

Virtual-8086 Mode Exceptions

#UD	The VMPTRST instruction is not recognized in virtual-8086 mode.
-----	---

Compatibility Mode Exceptions

#UD The VMPTRST instruction is not recognized in compatibility mode.

64-Bit Mode Exceptions

#GP(0) If the current privilege level is not 0.
 If the destination operand is in the CS, DS, ES, FS, or GS segments and the memory address is in a non-canonical form.

#PF(fault-code) If a page fault occurs in accessing the memory destination operand.

#SS(0) If the destination operand is in the SS segment and the memory address is in a non-canonical form.

#UD If operand is a register.
 If not in VMX operation.

VMREAD—Read Field from Virtual-Machine Control Structure

Opcode/ Instruction	Op/En	Description
NP OF 78 VMREAD r/m64, r64	MR	Reads a specified VMCS field (in 64-bit mode).
NP OF 78 VMREAD r/m32, r32	MR	Reads a specified VMCS field (outside 64-bit mode).

Instruction Operand Encoding

Op/En	Operand 1	Operand 2	Operand 3	Operand 4
MR	ModRM:r/m (w)	ModRM:reg (r)	NA	NA

Description

Reads a specified field from a VMCS and stores it into a specified destination operand (register or memory). In VMX root operation, the instruction reads from the current VMCS. If executed in VMX non-root operation, the instruction reads from the VMCS referenced by the VMCS link pointer field in the current VMCS.

The VMCS field is specified by the VMCS-field encoding contained in the register source operand. Outside IA-32e mode, the source operand has 32 bits, regardless of the value of CS.D. In 64-bit mode, the source operand has 64 bits.

The effective size of the destination operand, which may be a register or in memory, is always 32 bits outside IA-32e mode (the setting of CS.D is ignored with respect to operand size) and 64 bits in 64-bit mode. If the VMCS field specified by the source operand is shorter than this effective operand size, the high bits of the destination operand are cleared to 0. If the VMCS field is longer, then the high bits of the field are not read.

Note that any faults resulting from accessing a memory destination operand can occur only after determining, in the operation section below, that the relevant VMCS pointer is valid and that the specified VMCS field is supported.

Operation

```

IF (not in VMX operation) or (CR0.PE = 0) or (RFLAGS.VM = 1) or (IA32_EFER.LMA = 1 and CS.L = 0)
  THEN #UD;
ELSIF in VMX non-root operation AND ("VMCS shadowing" is 0 OR source operand sets bits in range 63:15 OR
VMREAD bit corresponding to bits 14:0 of source operand is 1)1
  THEN VMexit;
ELSIF CPL > 0
  THEN #GP(0);
ELSIF (in VMX root operation AND current-VMCS pointer is not valid) OR
(in VMX non-root operation AND VMCS link pointer is not valid)
  THEN VMfailInvalid;
ELSIF source operand does not correspond to any VMCS field
  THEN VMfailValid(VMREAD/VMWRITE from/to unsupported VMCS component);
ELSE
  IF in VMX root operation
    THEN destination operand := contents of field indexed by source operand in current VMCS;
    ELSE destination operand := contents of field indexed by source operand in VMCS referenced by VMCS link pointer;
  FI;
  VMsucceed;
FI;

```

1. The VMREAD bit for a source operand is defined as follows. Let *x* be the value of bits 14:0 of the source operand and let *addr* be the VMREAD-bitmap address. The corresponding VMREAD bit is in bit position *x* & 7 of the byte at physical address *addr* | (*x* >> 3).

Flags Affected

See the operation section and Section 31.2.

Protected Mode Exceptions

#GP(0)	If the current privilege level is not 0. If a memory destination operand effective address is outside the CS, DS, ES, FS, or GS segment limit. If the DS, ES, FS, or GS register contains an unusable segment. If the destination operand is located in a read-only data segment or any code segment.
#PF(fault-code)	If a page fault occurs in accessing a memory destination operand.
#SS(0)	If a memory destination operand effective address is outside the SS segment limit. If the SS register contains an unusable segment.
#UD	If not in VMX operation.

Real-Address Mode Exceptions

#UD	The VMREAD instruction is not recognized in real-address mode.
-----	--

Virtual-8086 Mode Exceptions

#UD	The VMREAD instruction is not recognized in virtual-8086 mode.
-----	--

Compatibility Mode Exceptions

#UD	The VMREAD instruction is not recognized in compatibility mode.
-----	---

64-Bit Mode Exceptions

#GP(0)	If the current privilege level is not 0. If the memory destination operand is in the CS, DS, ES, FS, or GS segments and the memory address is in a non-canonical form.
#PF(fault-code)	If a page fault occurs in accessing a memory destination operand.
#SS(0)	If the memory destination operand is in the SS segment and the memory address is in a non-canonical form.
#UD	If not in VMX operation.

VMRESUME—Resume Virtual Machine

See VMLAUNCH/VMRESUME—Launch/Resume Virtual Machine.

VMWRITE—Write Field to Virtual-Machine Control Structure

Opcode/ Instruction	Op/En	Description
NP OF 79 VMWRITE r64, r/m64	RM	Writes a specified VMCS field (in 64-bit mode).
NP OF 79 VMWRITE r32, r/m32	RM	Writes a specified VMCS field (outside 64-bit mode).

Instruction Operand Encoding

Op/En	Operand 1	Operand 2	Operand 3	Operand 4
RM	ModRM:reg (r)	ModRM:r/m (r)	NA	NA

Description

Writes the contents of a primary source operand (register or memory) to a specified field in a VMCS. In VMX root operation, the instruction writes to the current VMCS. If executed in VMX non-root operation, the instruction writes to the VMCS referenced by the VMCS link pointer field in the current VMCS.

The VMCS field is specified by the VMCS-field encoding contained in the register secondary source operand. Outside IA-32e mode, the secondary source operand is always 32 bits, regardless of the value of CS.D. In 64-bit mode, the secondary source operand has 64 bits.

The effective size of the primary source operand, which may be a register or in memory, is always 32 bits outside IA-32e mode (the setting of CS.D is ignored with respect to operand size) and 64 bits in 64-bit mode. If the VMCS field specified by the secondary source operand is shorter than this effective operand size, the high bits of the primary source operand are ignored. If the VMCS field is longer, then the high bits of the field are cleared to 0.

Note that any faults resulting from accessing a memory source operand occur after determining, in the operation section below, that the relevant VMCS pointer is valid but before determining if the destination VMCS field is supported.

Operation

IF (not in VMX operation) or (CR0.PE = 0) or (RFLAGS.VM = 1) or (IA32_EFER.LMA = 1 and CS.L = 0)
THEN #UD;

ELSIF in VMX non-root operation AND (“VMCS shadowing” is 0 OR secondary source operand sets bits in range 63:15 OR VMWRITE bit corresponding to bits 14:0 of secondary source operand is 1)¹

THEN VMexit;

ELSIF CPL > 0

THEN #GP(0);

ELSIF (in VMX root operation AND current-VMCS pointer is not valid) OR

(in VMX non-root operation AND VMCS-link pointer is not valid)

THEN VMfailInvalid;

ELSIF secondary source operand does not correspond to any VMCS field

THEN VMfailValid(VMREAD/VMWRITE from/to unsupported VMCS component);

ELSIF VMCS field indexed by secondary source operand is a VM-exit information field AND processor does not support writing to such fields²

THEN VMfailValid(VMWRITE to read-only VMCS component);

ELSE

1. The VMWRITE bit for a secondary source operand is defined as follows. Let *x* be the value of bits 14:0 of the secondary source operand and let *addr* be the VMWRITE-bitmap address. The corresponding VMWRITE bit is in bit position $x \& 7$ of the byte at physical address $addr | (x \gg 3)$.

2. Software can discover whether these fields can be written by reading the VMX capability MSR IA32_VMX_MISC (see Appendix A.6).

IF in VMX root operation

THEN field indexed by secondary source operand in current VMCS := primary source operand;

ELSE field indexed by secondary source operand in VMCS referenced by VMCS link pointer := primary source operand;

FI;

VMsucceed;

FI;

Flags Affected

See the operation section and Section 31.2.

Protected Mode Exceptions

#GP(0)	If the current privilege level is not 0. If a memory source operand effective address is outside the CS, DS, ES, FS, or GS segment limit. If the DS, ES, FS, or GS register contains an unusable segment. If the source operand is located in an execute-only code segment.
#PF(fault-code)	If a page fault occurs in accessing a memory source operand.
#SS(0)	If a memory source operand effective address is outside the SS segment limit. If the SS register contains an unusable segment.
#UD	If not in VMX operation.

Real-Address Mode Exceptions

#UD	The VMWRITE instruction is not recognized in real-address mode.
-----	---

Virtual-8086 Mode Exceptions

#UD	The VMWRITE instruction is not recognized in virtual-8086 mode.
-----	---

Compatibility Mode Exceptions

#UD	The VMWRITE instruction is not recognized in compatibility mode.
-----	--

64-Bit Mode Exceptions

#GP(0)	If the current privilege level is not 0. If the memory source operand is in the CS, DS, ES, FS, or GS segments and the memory address is in a non-canonical form.
#PF(fault-code)	If a page fault occurs in accessing a memory source operand.
#SS(0)	If the memory source operand is in the SS segment and the memory address is in a non-canonical form.
#UD	If not in VMX operation.

VMXOFF—Leave VMX Operation

Opcode/ Instruction	Op/En	Description
OF 01 C4 VMXOFF	Z0	Leaves VMX operation.

Instruction Operand Encoding

Op/En	Operand 1	Operand 2	Operand 3	Operand 4
Z0	NA	NA	NA	NA

Description

Takes the logical processor out of VMX operation, unblocks INIT signals, conditionally re-enables A20M, and clears any address-range monitoring.¹

Operation

IF (not in VMX operation) or (CR0.PE = 0) or (RFLAGS.VM = 1) or (IA32_EFER.LMA = 1 and CS.L = 0)

THEN #UD;

ELSIF in VMX non-root operation

THEN VMexit;

ELSIF CPL > 0

THEN #GP(0);

ELSIF dual-monitor treatment of SMIs and SMM is active

THEN VMfail(VMXOFF under dual-monitor treatment of SMIs and SMM);

ELSE

leave VMX operation;

unblock INIT;

IF IA32_SMM_MONITOR_CTL[2] = 0²

THEN unblock SMIs;

IF outside SMX operation³

THEN unblock and enable A20M;

FI;

clear address-range monitoring;

VMsucceed;

FI;

Flags Affected

See the operation section and Section 31.2.

Protected Mode Exceptions

#GP(0) If executed in VMX root operation with CPL > 0.

1. See the information on MONITOR/MWAIT in Chapter 9, “Multiple-Processor Management,” of the Intel[®] 64 and IA-32 Architectures Software Developer’s Manual, Volume 3A.
2. Setting IA32_SMM_MONITOR_CTL[bit 2] to 1 prevents VMXOFF from unblocking SMIs regardless of the value of the register’s value bit (bit 0). Not all processors allow this bit to be set to 1. Software should consult the VMX capability MSR IA32_VMX_MISC (see Appendix A.6) to determine whether this is allowed.
3. A logical processor is outside SMX operation if GETSEC[SENDER] has not been executed or if GETSEC[SEXIT] was executed after the last execution of GETSEC[SENDER]. See Chapter 6, “Safer Mode Extensions Reference.”

#UD If executed outside VMX operation.

Real-Address Mode Exceptions

#UD The VMXOFF instruction is not recognized in real-address mode.

Virtual-8086 Mode Exceptions

#UD The VMXOFF instruction is not recognized in virtual-8086 mode.

Compatibility Mode Exceptions

#UD The VMXOFF instruction is not recognized in compatibility mode.

64-Bit Mode Exceptions

#GP(0) If executed in VMX root operation with CPL > 0.

#UD If executed outside VMX operation.

VMXON—Enter VMX Operation

Opcode/ Instruction	Op/En	Description
F3 0F C7 /6 VMXON m64	M	Enter VMX root operation.

Instruction Operand Encoding

Op/En	Operand 1	Operand 2	Operand 3	Operand 4
M	ModRM:r/m (r)	NA	NA	NA

Description

Puts the logical processor in VMX operation with no current VMCS, blocks INIT signals, disables A20M, and clears any address-range monitoring established by the MONITOR instruction.¹

The operand of this instruction is a 4KB-aligned physical address (the VMXON pointer) that references the VMXON region, which the logical processor may use to support VMX operation. This operand is always 64 bits and is always in memory.

Operation

IF (register operand) or (CR0.PE = 0) or (CR4.VMXE = 0) or (RFLAGS.VM = 1) or (IA32_EFER.LMA = 1 and CS.L = 0)
THEN #UD;

ELSIF not in VMX operation
THEN

IF (CPL > 0) or (in A20M mode) or
(the values of CR0 and CR4 are not supported in VMX operation; see Section 24.8) or
(bit 0 (lock bit) of IA32_FEATURE_CONTROL MSR is clear) or
(in SMX operation² and bit 1 of IA32_FEATURE_CONTROL MSR is clear) or
(outside SMX operation and bit 2 of IA32_FEATURE_CONTROL MSR is clear)

THEN #GP(0);

ELSE

addr := contents of 64-bit in-memory source operand;

IF addr is not 4KB-aligned or

addr sets any bits beyond the physical-address width³

THEN VMfailInvalid;

ELSE

rev := 32 bits located at physical address addr;

IF rev[30:0] ≠ VMCS revision identifier supported by processor OR rev[31] = 1

THEN VMfailInvalid;

ELSE

current-VMCS pointer := FFFFFFFF_FFFFFFFFH;

enter VMX operation;

block INIT signals;

block and disable A20M;

1. See the information on MONITOR/MWAIT in Chapter 9, “Multiple-Processor Management,” of the Intel® 64 and IA-32 Architectures Software Developer’s Manual, Volume 3A.

2. A logical processor is in SMX operation if GETSEC[SEXIT] has not been executed since the last execution of GETSEC[SENDER]. A logical processor is outside SMX operation if GETSEC[SENDER] has not been executed or if GETSEC[SEXIT] was executed after the last execution of GETSEC[SENDER]. See Chapter 6, “Safer Mode Extensions Reference.”

3. If IA32_VMX_BASIC[48] is read as 1, VMfailInvalid occurs if addr sets any bits in the range 63:32; see Appendix A.1.

```

clear address-range monitoring;
IF the processor supports Intel PT but does not allow it to be used in VMX operation1
    THEN IA32_RTIT_CTL.TraceEn := 0;
FI;
VMsucceed;
FI;
FI;
FI;
ELSIF in VMX non-root operation
    THEN VMexit;
ELSIF CPL > 0
    THEN #GP(0);
    ELSE VMfail("VMXON executed in VMX root operation");
FI;

```

Flags Affected

See the operation section and Section 31.2.

Protected Mode Exceptions

#GP(0)	<p>If executed outside VMX operation with CPL>0 or with invalid CR0 or CR4 fixed bits.</p> <p>If executed in A20M mode.</p> <p>If the memory source operand effective address is outside the CS, DS, ES, FS, or GS segment limit.</p> <p>If the DS, ES, FS, or GS register contains an unusable segment.</p> <p>If the source operand is located in an execute-only code segment.</p> <p>If the value of the IA32_FEATURE_CONTROL MSR does not support entry to VMX operation in the current processor mode.</p>
#PF(fault-code)	If a page fault occurs in accessing the memory source operand.
#SS(0)	<p>If the memory source operand effective address is outside the SS segment limit.</p> <p>If the SS register contains an unusable segment.</p>
#UD	<p>If operand is a register.</p> <p>If executed with CR4.VMXE = 0.</p>

Real-Address Mode Exceptions

#UD	The VMXON instruction is not recognized in real-address mode.
-----	---

Virtual-8086 Mode Exceptions

#UD	The VMXON instruction is not recognized in virtual-8086 mode.
-----	---

Compatibility Mode Exceptions

#UD	The VMXON instruction is not recognized in compatibility mode.
-----	--

64-Bit Mode Exceptions

#GP(0)	<p>If executed outside VMX operation with CPL > 0 or with invalid CR0 or CR4 fixed bits.</p> <p>If executed in A20M mode.</p> <p>If the source operand is in the CS, DS, ES, FS, or GS segments and the memory address is in a non-canonical form.</p>
--------	---

1. Software should read the VMX capability MSR IA32_VMX_MISC to determine whether the processor allows Intel PT to be used in VMX operation (see Appendix A.6).

VMX INSTRUCTION REFERENCE

	If the value of the IA32_FEATURE_CONTROL MSR does not support entry to VMX operation in the current processor mode.
#PF(fault-code)	If a page fault occurs in accessing the memory source operand.
#SS(0)	If the source operand is in the SS segment and the memory address is in a non-canonical form.
#UD	If operand is a register. If executed with CR4.VMXE = 0.

31.4 VM INSTRUCTION ERROR NUMBERS

For certain error conditions, the VM-instruction error field is loaded with an error number to indicate the source of the error. Table 31-1 lists VM-instruction error numbers.

Table 31-1. VM-Instruction Error Numbers

Error Number	Description
1	VMCALL executed in VMX root operation
2	VMCLEAR with invalid physical address
3	VMCLEAR with VMXON pointer
4	VMLAUNCH with non-clear VMCS
5	VMRESUME with non-launched VMCS
6	VMRESUME after VMXOFF (VMXOFF and VMXON between VMLAUNCH and VMRESUME) ^a
7	VM entry with invalid control field(s) ^{b,c}
8	VM entry with invalid host-state field(s) ^b
9	VMPTRLD with invalid physical address
10	VMPTRLD with VMXON pointer
11	VMPTRLD with incorrect VMCS revision identifier
12	VMREAD/VMWRITE from/to unsupported VMCS component
13	VMWRITE to read-only VMCS component
15	VMXON executed in VMX root operation
16	VM entry with invalid executive-VMCS pointer ^b
17	VM entry with non-launched executive VMCS ^b
18	VM entry with executive-VMCS pointer not VMXON pointer (when attempting to deactivate the dual-monitor treatment of SMIs and SMM) ^b
19	VMCALL with non-clear VMCS (when attempting to activate the dual-monitor treatment of SMIs and SMM)
20	VMCALL with invalid VM-exit control fields
22	VMCALL with incorrect MSEG revision identifier (when attempting to activate the dual-monitor treatment of SMIs and SMM)
23	VMXOFF under dual-monitor treatment of SMIs and SMM
24	VMCALL with invalid SMM-monitor features (when attempting to activate the dual-monitor treatment of SMIs and SMM)
25	VM entry with invalid VM-execution control fields in executive VMCS (when attempting to return from SMM) ^{b,c}
26	VM entry with events blocked by MOV SS.
28	Invalid operand to INVEPT/INVVPID.

NOTES:

- a. Earlier versions of this manual described this error as “VMRESUME with a corrupted VMCS”.
- b. VM-entry checks on control fields and host-state fields may be performed in any order. Thus, an indication by error number of one cause does not imply that there are not also other errors. Different processors may give different error numbers for the same VMCS.
- c. Error number 7 is not used for VM entries that return from SMM that fail due to invalid VM-execution control fields in the executive VMCS. Error number 25 is used for these cases.

This chapter describes aspects of IA-64 and IA-32 architecture used in system management mode (SMM).

SMM provides an alternate operating environment that can be used to monitor and manage various system resources for more efficient energy usage, to control system hardware, and/or to run proprietary code. It was introduced into the IA-32 architecture in the Intel386 SL processor (a mobile specialized version of the Intel386 processor). It is also available in the Pentium M, Pentium 4, Intel Xeon, P6 family, and Pentium and Intel486 processors (beginning with the enhanced versions of the Intel486 SL and Intel486 processors).

32.1 SYSTEM MANAGEMENT MODE OVERVIEW

SMM is a special-purpose operating mode provided for handling system-wide functions like power management, system hardware control, or proprietary OEM-designed code. It is intended for use only by system firmware, not by applications software or general-purpose systems software. The main benefit of SMM is that it offers a distinct and easily isolated processor environment that operates transparently to the operating system or executive and software applications.

When SMM is invoked through a system management interrupt (SMI), the processor saves the current state of the processor (the processor's context), then switches to a separate operating environment defined by a new address space. The system management software executive (SMI handler) starts execution in that environment, and the critical code and data of the SMI handler reside in a physical memory region (SMRAM) within that address space. While in SMM, the processor executes SMI handler code to perform operations such as powering down unused disk drives or monitors, executing proprietary code, or placing the whole system in a suspended state. When the SMI handler has completed its operations, it executes a resume (RSM) instruction. This instruction causes the processor to reload the saved context of the processor, switch back to protected or real mode, and resume executing the interrupted application or operating-system program or task.

The following SMM mechanisms make it transparent to applications programs and operating systems:

- The only way to enter SMM is by means of an SMI.
- The processor executes SMM code in a separate address space that can be made inaccessible from the other operating modes.
- Upon entering SMM, the processor saves the context of the interrupted program or task.
- All interrupts normally handled by the operating system are disabled upon entry into SMM.
- The RSM instruction can be executed only in SMM.

Section 32.3 describes transitions into and out of SMM. The execution environment after entering SMM is in real-address mode with paging disabled ($CR0.PE = CR0.PG = 0$). In this initial execution environment, the SMI handler can address up to 4 GBytes of memory and can execute all I/O and system instructions. Section 32.5 describes in detail the initial SMM execution environment for an SMI handler and operation within that environment. The SMI handler may subsequently switch to other operating modes while remaining in SMM.

NOTES

Software developers should be aware that, even if a logical processor was using the physical-address extension (PAE) mechanism (introduced in the P6 family processors) or was in IA-32e mode before an SMI, this will not be the case after the SMI is delivered. This is because delivery of an SMI disables paging (see Table 32-4). (This does not apply if the dual-monitor treatment of SMIs and SMM is active; see Section 32.15.)

32.1.1 System Management Mode and VMX Operation

Traditionally, SMM services system management interrupts and then resumes program execution (back to the software stack consisting of executive and application software; see Section 32.2 through Section 32.13).

A virtual machine monitor (VMM) using VMX can act as a host to multiple virtual machines and each virtual machine can support its own software stack of executive and application software. On processors that support VMX, virtual-machine extensions may use system-management interrupts (SMIs) and system-management mode (SMM) in one of two ways:

- **Default treatment.** System firmware handles SMIs. The processor saves architectural states and critical states relevant to VMX operation upon entering SMM. When the firmware completes servicing SMIs, it uses RSM to resume VMX operation.
- **Dual-monitor treatment.** Two VM monitors collaborate to control the servicing of SMIs: one VMM operates outside of SMM to provide basic virtualization in support for guests; the other VMM operates inside SMM (while in VMX operation) to support system-management functions. The former is referred to as **executive monitor**, the latter **SMM-transfer monitor (STM)**.¹

The default treatment is described in Section 32.14, “Default Treatment of SMIs and SMM with VMX Operation and SMX Operation.” Dual-monitor treatment of SMM is described in Section 32.15, “Dual-Monitor Treatment of SMIs and SMM.”

32.2 SYSTEM MANAGEMENT INTERRUPT (SMI)

The only way to enter SMM is by signaling an SMI through the SMI# pin on the processor or through an SMI message received through the APIC bus. The SMI is a nonmaskable external interrupt that operates independently from the processor’s interrupt- and exception-handling mechanism and the local APIC. The SMI takes precedence over an NMI and a maskable interrupt. SMM is non-reentrant; that is, the SMI is disabled while the processor is in SMM.

NOTES

In the Pentium 4, Intel Xeon, and P6 family processors, when a processor that is designated as an application processor during an MP initialization sequence is waiting for a startup IPI (SIPI), it is in a mode where SMIs are masked. However if a SMI is received while an application processor is in the wait for SIPI mode, the SMI will be pended. The processor then responds on receipt of a SIPI by immediately servicing the pended SMI and going into SMM before handling the SIPI.

An SMI may be blocked for one instruction following execution of STI, MOV to SS, or POP into SS.

32.3 SWITCHING BETWEEN SMM AND THE OTHER PROCESSOR OPERATING MODES

Figure 2-3 shows how the processor moves between SMM and the other processor operating modes (protected, real-address, and virtual-8086). Signaling an SMI while the processor is in real-address, protected, or virtual-8086 modes always causes the processor to switch to SMM. Upon execution of the RSM instruction, the processor always returns to the mode it was in when the SMI occurred.

32.3.1 Entering SMM

The processor always handles an SMI on an architecturally defined “interruptible” point in program execution (which is commonly at an IA-32 architecture instruction boundary). When the processor receives an SMI, it waits for all instructions to retire and for all stores to complete. The processor then saves its current context in SMRAM (see Section 32.4), enters SMM, and begins to execute the SMI handler.

1. The dual-monitor treatment may not be supported by all processors. Software should consult the VMX capability MSR IA32_VMX_BASIC (see Appendix A.1) to determine whether it is supported.

Upon entering SMM, the processor signals external hardware that SMI handling has begun. The signaling mechanism used is implementation dependent. For the P6 family processors, an SMI acknowledge transaction is generated on the system bus and the multiplexed status signal EXF4 is asserted each time a bus transaction is generated while the processor is in SMM. For the Pentium and Intel486 processors, the SMIACK# pin is asserted.

An SMI has a greater priority than debug exceptions and external interrupts. Thus, if an NMI, maskable hardware interrupt, or a debug exception occurs at an instruction boundary along with an SMI, only the SMI is handled. Subsequent SMI requests are not acknowledged while the processor is in SMM. The first SMI interrupt request that occurs while the processor is in SMM (that is, after SMM has been acknowledged to external hardware) is latched and serviced when the processor exits SMM with the RSM instruction. The processor will latch only one SMI while in SMM.

See Section 32.5 for a detailed description of the execution environment when in SMM.

32.3.2 Exiting From SMM

The only way to exit SMM is to execute the RSM instruction. The RSM instruction is only available to the SMI handler; if the processor is not in SMM, attempts to execute the RSM instruction result in an invalid-opcode exception (#UD) being generated.

The RSM instruction restores the processor's context by loading the state save image from SMRAM back into the processor's registers. The processor then returns an SMIACK transaction on the system bus and returns program control back to the interrupted program.

NOTE

On processors that support the shadow-stack feature, RSM loads the SSP register from the state save image in SMRAM (see Table 32-3). The value is made canonical by sign-extension before loading it into SSP.

Upon successful completion of the RSM instruction, the processor signals external hardware that SMM has been exited. For the P6 family processors, an SMI acknowledge transaction is generated on the system bus and the multiplexed status signal EXF4 is no longer generated on bus cycles. For the Pentium and Intel486 processors, the SMIACK# pin is deserted.

If the processor detects invalid state information saved in the SMRAM, it enters the shutdown state and generates a special bus cycle to indicate it has entered shutdown state. Shutdown happens only in the following situations:

- A reserved bit in control register CR4 is set to 1 on a write to CR4. This error should not happen unless SMI handler code modifies reserved areas of the SMRAM saved state map (see Section 32.4.1). CR4 is saved in the state map in a reserved location and cannot be read or modified in its saved state.
- An illegal combination of bits is written to control register CR0, in particular PG set to 1 and PE set to 0, or NW set to 1 and CD set to 0.
- CR4.PCIDE would be set to 1 and IA32_EFER.LMA to 0.
- (For the Pentium and Intel486 processors only.) If the address stored in the SMBASE register when an RSM instruction is executed is not aligned on a 32-KByte boundary. This restriction does not apply to the P6 family processors.
- CR4.CET would be set to 1 and CR0.WP to 0.

In the shutdown state, Intel processors stop executing instructions until a RESET#, INIT# or NMI# is asserted. While Pentium family processors recognize the SMI# signal in shutdown state, P6 family and Intel486 processors do not. Intel does not support using SMI# to recover from shutdown states for any processor family; the response of processors in this circumstance is not well defined. On Pentium 4 and later processors, shutdown will inhibit INTR and A20M but will not change any of the other inhibits. On these processors, NMIs will be inhibited if no action is taken in the SMI handler to uninhibit them (see Section 32.8).

If the processor is in the HALT state when the SMI is received, the processor handles the return from SMM slightly differently (see Section 32.10). Also, the SMBASE address can be changed on a return from SMM (see Section 32.11).

32.4 SMRAM

Upon entering SMM, the processor switches to a new address space. Because paging is disabled upon entering SMM, this initial address space maps all memory accesses to the low 4 GBytes of the processor's physical address space. The SMI handler's critical code and data reside in a memory region referred to as system-management RAM (SMRAM). The processor uses a pre-defined region within SMRAM to save the processor's pre-SMI context. SMRAM can also be used to store system management information (such as the system configuration and specific information about powered-down devices) and OEM-specific information.

The default SMRAM size is 64 KBytes beginning at a base physical address in physical memory called the SMBASE (see Figure 32-1). The SMBASE default value following a hardware reset is 30000H. The processor looks for the first instruction of the SMI handler at the address [SMBASE + 8000H]. It stores the processor's state in the area from [SMBASE + FE00H] to [SMBASE + FFFFH]. See Section 32.4.1 for a description of the mapping of the state save area.

The system logic is minimally required to decode the physical address range for the SMRAM from [SMBASE + 8000H] to [SMBASE + FFFFH]. A larger area can be decoded if needed. The size of this SMRAM can be between 32 KBytes and 4 GBytes.

The location of the SMRAM can be changed by changing the SMBASE value (see Section 32.11). It should be noted that all processors in a multiple-processor system are initialized with the same SMBASE value (30000H). Initialization software must sequentially place each processor in SMM and change its SMBASE so that it does not overlap those of other processors.

The actual physical location of the SMRAM can be in system memory or in a separate RAM memory. The processor generates an SMI acknowledge transaction (P6 family processors) or asserts the SMIACK# pin (Pentium and Intel486 processors) when the processor receives an SMI (see Section 32.3.1).

System logic can use the SMI acknowledge transaction or the assertion of the SMIACK# pin to decode accesses to the SMRAM and redirect them (if desired) to specific SMRAM memory. If a separate RAM memory is used for SMRAM, system logic should provide a programmable method of mapping the SMRAM into system memory space when the processor is not in SMM. This mechanism will enable start-up procedures to initialize the SMRAM space (that is, load the SMI handler) before executing the SMI handler during SMM.

32.4.1 SMRAM State Save Map

When an IA-32 processor that does not support Intel 64 architecture initially enters SMM, it writes its state to the state save area of the SMRAM. The state save area begins at [SMBASE + 8000H + 7FFFH] and extends down to [SMBASE + 8000H + 7E00H]. Table 32-1 shows the state save map. The offset in column 1 is relative to the SMBASE value plus 8000H. Reserved spaces should not be used by software.

Some of the registers in the SMRAM state save area (marked YES in column 3) may be read and changed by the SMI handler, with the changed values restored to the processor registers by the RSM instruction. Some register images are read-only, and must not be modified (modifying these registers will result in unpredictable behavior). An SMI handler should not rely on any values stored in an area that is marked as reserved.

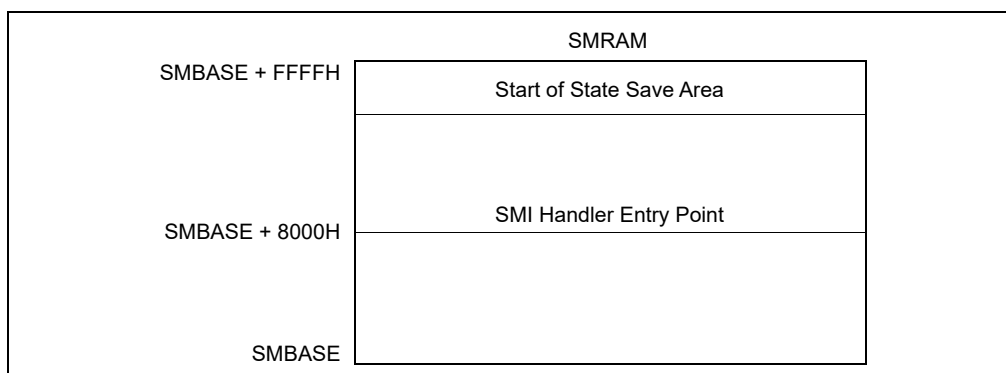

Figure 32-1. SMRAM Usage

Table 32-1. SMRAM State Save Map

Offset (Added to SMBASE + 8000H)	Register	Writable?
7FFCH	CR0	No
7FF8H	CR3	No
7FF4H	EFLAGS	Yes
7FF0H	EIP	Yes
7FECH	EDI	Yes
7FE8H	ESI	Yes
7FE4H	EBP	Yes
7FE0H	ESP	Yes
7FDCH	EBX	Yes
7FD8H	EDX	Yes
7FD4H	ECX	Yes
7FD0H	EAX	Yes
7FCCH	DR6	No
7FC8H	DR7	No
7FC4H	TR ¹	No
7FC0H	Reserved	No
7FBCH	GS ¹	No
7FB8H	FS ¹	No
7FB4H	DS ¹	No
7FB0H	SS ¹	No
7FACH	CS ¹	No
7FA8H	ES ¹	No
7FA4H	I/O State Field, see Section 32.7	No
7FA0H	I/O Memory Address Field, see Section 32.7	No
7F9FH-7F03H	Reserved	No
7F02H	Auto HALT Restart Field (Word)	Yes
7F00H	I/O Instruction Restart Field (Word)	Yes
7EFCH	SMM Revision Identifier Field (Doubleword)	No
7EF8H	SMBASE Field (Doubleword)	Yes
7EF7H - 7E00H	Reserved	No

NOTE:

1. The two most significant bytes are reserved.

The following registers are saved (but not readable) and restored upon exiting SMM:

- Control register CR4. (This register is cleared to all 0s when entering SMM).
- The hidden segment descriptor information stored in segment registers CS, DS, ES, FS, GS, and SS.

If an SMI request is issued for the purpose of powering down the processor, the values of all reserved locations in the SMM state save must be saved to nonvolatile memory.

The following state is not automatically saved and restored following an SMI and the RSM instruction, respectively:

- Debug registers DR0 through DR3.
- The x87 FPU registers.
- The MTRRs.
- Control register CR2.
- The model-specific registers (for the P6 family and Pentium processors) or test registers TR3 through TR7 (for the Pentium and Intel486 processors).
- The state of the trap controller.
- The machine-check architecture registers.
- The APIC internal interrupt state (ISR, IRR, etc.).
- The microcode update state.

If an SMI is used to power down the processor, a power-on reset will be required before returning to SMM, which will reset much of this state back to its default values. So an SMI handler that is going to trigger power down should first read these registers listed above directly, and save them (along with the rest of RAM) to nonvolatile storage. After the power-on reset, the continuation of the SMI handler should restore these values, along with the rest of the system's state. Anytime the SMI handler changes these registers in the processor, it must also save and restore them.

NOTES

A small subset of the MSRs (such as, the time-stamp counter and performance-monitoring counters) are not arbitrarily writable and therefore cannot be saved and restored. SMM-based power-down and restoration should only be performed with operating systems that do not use or rely on the values of these registers.

Operating system developers should be aware of this fact and ensure that their operating-system assisted power-down and restoration software is immune to unexpected changes in these register values.

32.4.1.1 SMRAM State Save Map and Intel 64 Architecture

When the processor initially enters SMM, it writes its state to the state save area of the SMRAM. The state save area on an Intel 64 processor at [SMBASE + 8000H + 7FFFH] and extends to [SMBASE + 8000H + 7C00H].

Support for Intel 64 architecture is reported by CPUID.80000001:EDX[29] = 1. The layout of the SMRAM state save map is shown in Table 32-3.

Additionally, the SMRAM state save map shown in Table 32-3 also applies to processors with the following CPUID signatures listed in Table 32-2, irrespective of the value in CPUID.80000001:EDX[29].

Table 32-2. Processor Signatures and 64-bit SMRAM State Save Map Format

DisplayFamily_DisplayModel	Processor Families/Processor Number Series
06_17H	Intel Xeon Processor 5200, 5400 series, Intel Core 2 Quad processor Q9xxx, Intel Core 2 Duo processors E8000, T9000,
06_0FH	Intel Xeon Processor 3000, 3200, 5100, 5300, 7300 series, Intel Core 2 Quad, Intel Core 2 Extreme, Intel Core 2 Duo processors, Intel Pentium dual-core processors
06_1CH	45 nm Intel Atom® processors

Table 32-3. SMRAM State Save Map for Intel 64 Architecture

Offset (Added to SMBASE + 8000H)	Register	Writable?
7FF8H	CR0	No
7FF0H	CR3	No
7FE8H	RFLAGS	Yes
7FE0H	IA32_EFER	Yes
7FD8H	RIP	Yes
7FD0H	DR6	No
7FC8H	DR7	No
7FC4H	TR SEL ¹	No
7FC0H	LDTR SEL ¹	No
7FBCH	GS SEL ¹	No
7FB8H	FS SEL ¹	No
7FB4H	DS SEL ¹	No
7FB0H	SS SEL ¹	No
7FACH	CS SEL ¹	No
7FA8H	ES SEL ¹	No
7FA4H	IO_MISC	No
7F9CH	IO_MEM_ADDR	No
7F94H	RDI	Yes
7F8CH	RSI	Yes
7F84H	RBP	Yes
7F7CH	RSP	Yes
7F74H	RBX	Yes
7F6CH	RDX	Yes
7F64H	RCX	Yes
7F5CH	RAX	Yes
7F54H	R8	Yes
7F4CH	R9	Yes
7F44H	R10	Yes
7F3CH	R11	Yes
7F34H	R12	Yes
7F2CH	R13	Yes
7F24H	R14	Yes
7F1CH	R15	Yes
7F1BH-7F04H	Reserved	No
7F02H	Auto HALT Restart Field (Word)	Yes
7F00H	I/O Instruction Restart Field (Word)	Yes
7EFCH	SMM Revision Identifier Field (Doubleword)	No
7EF8H	SMBASE Field (Doubleword)	Yes

Table 32-3. SMRAM State Save Map for Intel 64 Architecture (Contd.)

Offset (Added to SMBASE + 8000H)	Register	Writable?
7EF7H - 7EE4H	Reserved	No
7EE0H	Setting of "enable EPT" VM-execution control	No
7ED8H	Value of EPTP VM-execution control field	No
7ED7H - 7ECC0H	Reserved	No
7EC8H	SSP	Yes
7EC7H - 7EA0H	Reserved	No
7E9CH	LDT Base (lower 32 bits)	No
7E98H	Reserved	No
7E94H	IDT Base (lower 32 bits)	No
7E90H	Reserved	No
7E8CH	GDT Base (lower 32 bits)	No
7E8BH - 7E48H	Reserved	No
7E40H	CR4 (64 bits)	No
7E3FH - 7DF0H	Reserved	No
7DE8H	IO_RIP	Yes
7DE7H - 7DDCH	Reserved	No
7DD8H	IDT Base (Upper 32 bits)	No
7DD4H	LDT Base (Upper 32 bits)	No
7DD0H	GDT Base (Upper 32 bits)	No
7DCFH - 7C00H	Reserved	No

NOTE:

1. The two most significant bytes are reserved.

32.4.2 SMRAM Caching

An IA-32 processor does not automatically write back and invalidate its caches before entering SMM or before exiting SMM. Because of this behavior, care must be taken in the placement of the SMRAM in system memory and in the caching of the SMRAM to prevent cache incoherence when switching back and forth between SMM and protected mode operation. Any of the following three methods of locating the SMRAM in system memory will guarantee cache coherency.

- Place the SMRAM in a dedicated section of system memory that the operating system and applications are prevented from accessing. Here, the SMRAM can be designated as cacheable (WB, WT, or WC) for optimum processor performance, without risking cache incoherence when entering or exiting SMM.
- Place the SMRAM in a section of memory that overlaps an area used by the operating system (such as the video memory), but designate the SMRAM as uncacheable (UC). This method prevents cache access when in SMM to maintain cache coherency, but the use of uncacheable memory reduces the performance of SMM code.
- Place the SMRAM in a section of system memory that overlaps an area used by the operating system and/or application code, but explicitly flush (write back and invalidate) the caches upon entering and exiting SMM mode. This method maintains cache coherency, but incurs the overhead of two complete cache flushes.

For Pentium 4, Intel Xeon, and P6 family processors, a combination of the first two methods of locating the SMRAM is recommended. Here the SMRAM is split between an overlapping and a dedicated region of memory. Upon entering SMM, the SMRAM space that is accessed overlaps video memory (typically located in low memory). This SMRAM section is designated as UC memory. The initial SMM code then jumps to a second SMRAM section that is

located in a dedicated region of system memory (typically in high memory). This SMRAM section can be cached for optimum processor performance.

For systems that explicitly flush the caches upon entering SMM (the third method described above), the cache flush can be accomplished by asserting the FLUSH# pin at the same time as the request to enter SMM (generally initiated by asserting the SMI# pin). The priorities of the FLUSH# and SMI# pins are such that the FLUSH# is serviced first. To guarantee this behavior, the processor requires that the following constraints on the interaction of FLUSH# and SMI# be met. In a system where the FLUSH# and SMI# pins are synchronous and the set up and hold times are met, then the FLUSH# and SMI# pins may be asserted in the same clock. In asynchronous systems, the FLUSH# pin must be asserted at least one clock before the SMI# pin to guarantee that the FLUSH# pin is serviced first.

Upon leaving SMM (for systems that explicitly flush the caches), the WBINVD instruction should be executed prior to leaving SMM to flush the caches.

NOTES

In systems based on the Pentium processor that use the FLUSH# pin to write back and invalidate cache contents before entering SMM, the processor will prefetch at least one cache line in between when the Flush Acknowledge cycle is run and the subsequent recognition of SMI# and the assertion of SMIACK#.

It is the obligation of the system to ensure that these lines are not cached by returning KEN# inactive to the Pentium processor.

32.4.2.1 System Management Range Registers (SMRR)

SMI handler code and data stored by SMM code resides in SMRAM. The SMRR interface is an enhancement in Intel 64 architecture to limit cacheable reference of addresses in SMRAM to code running in SMM. The SMRR interface can be configured only by code running in SMM. Details of SMRR is described in Section 12.11.2.4.

32.5 SMI HANDLER EXECUTION ENVIRONMENT

Section 32.5.1 describes the initial execution environment for an SMI handler. An SMI handler may re-configure its execution environment to other supported operating modes. Section 32.5.2 discusses modifications an SMI handler can make to its execution environment. Section 32.5.3 discusses Control-flow Enforcement Technology (CET) interactions in the environment.

32.5.1 Initial SMM Execution Environment

After saving the current context of the processor, the processor initializes its core registers to the values shown in Table 32-4. Upon entering SMM, the PE and PG flags in control register CR0 are cleared, which places the processor in an environment similar to real-address mode. The differences between the SMM execution environment and the real-address mode execution environment are as follows:

- The addressable address space ranges from 0 to FFFFFFFFH (4 GBytes).
- The normal 64-KByte segment limit for real-address mode is increased to 4 GBytes.
- The default operand and address sizes are set to 16 bits, which restricts the addressable SMRAM address space to the 1-MByte real-address mode limit for native real-address-mode code. However, operand-size and address-size override prefixes can be used to access the address space beyond the 1-MByte.

Table 32-4. Processor Register Initialization in SMM

Register	Contents
General-purpose registers	Undefined
EFLAGS	00000002H
EIP	00008000H
CS selector	SMM Base shifted right 4 bits (default 3000H)

Table 32-4. Processor Register Initialization in SMM

CS base	SMM Base (default 30000H)
DS, ES, FS, GS, SS Selectors	0000H
DS, ES, FS, GS, SS Bases	000000000H
DS, ES, FS, GS, SS Limits	0FFFFFFFFH
CR0	PE, EM, TS, and PG flags set to 0; others unmodified
CR4	Cleared to zero
DR6	Undefined
DR7	00000400H

- Near jumps and calls can be made to anywhere in the 4-GByte address space if a 32-bit operand-size override prefix is used. Due to the real-address-mode style of base-address formation, a far call or jump cannot transfer control to a segment with a base address of more than 20 bits (1 MByte). However, since the segment limit in SMM is 4 GBytes, offsets into a segment that go beyond the 1-MByte limit are allowed when using 32-bit operand-size override prefixes. Any program control transfer that does not have a 32-bit operand-size override prefix truncates the EIP value to the 16 low-order bits.
- Data and the stack can be located anywhere in the 4-GByte address space, but can be accessed only with a 32-bit address-size override if they are located above 1 MByte. As with the code segment, the base address for a data or stack segment cannot be more than 20 bits.

The value in segment register CS is automatically set to the default of 30000H for the SMBASE shifted 4 bits to the right; that is, 3000H. The EIP register is set to 8000H. When the EIP value is added to shifted CS value (the SMBASE), the resulting linear address points to the first instruction of the SMI handler.

The other segment registers (DS, SS, ES, FS, and GS) are cleared to 0 and their segment limits are set to 4 GBytes. In this state, the SMRAM address space may be treated as a single flat 4-GByte linear address space. If a segment register is loaded with a 16-bit value, that value is then shifted left by 4 bits and loaded into the segment base (hidden part of the segment register). The limits and attributes are not modified.

Maskable hardware interrupts, exceptions, NMI interrupts, SMI interrupts, A20M interrupts, single-step traps, breakpoint traps, and INIT operations are inhibited when the processor enters SMM. Maskable hardware interrupts, exceptions, single-step traps, and breakpoint traps can be enabled in SMM if the SMM execution environment provides and initializes an interrupt table and the necessary interrupt and exception handlers (see Section 32.6).

32.5.2 SMI Handler Operating Mode Switching

Within SMM, an SMI handler may change the processor's operating mode (e.g., to enable PAE paging, enter 64-bit mode, etc.) after it has made proper preparation and initialization to do so. For example, if switching to 32-bit protected mode, the SMI handler should follow the guidelines provided in Chapter 10, "Processor Management and Initialization." If the SMI handler does wish to change operating mode, it is responsible for executing the appropriate mode-transition code after each SMI.

It is recommended that the SMI handler make use of all means available to protect the integrity of its critical code and data. In particular, it should use the system-management range register (SMRR) interface if it is available (see Section 11.11.2.4). The SMRR interface can protect only the first 4 GBytes of the physical address space. The SMI handler should take that fact into account if it uses operating modes that allow access to physical addresses beyond that 4-GByte limit (e.g., PAE paging or 64-bit mode).

Execution of the RSM instruction restores the pre-SMI processor state from the SMRAM state-state map (see Section 32.4.1) into which it was stored when the processor entered SMM. (The SMBASE field in the SMRAM state-state map does not determine the state following RSM but rather the initial environment following the next entry to SMM.) Any required change to operating mode is performed by the RSM instruction; there is no need for the SMI handler to change modes explicitly prior to executing RSM.

32.5.3 Control-flow Enforcement Technology Interactions

On processors that support CET shadow stacks, when the processor enters SMM, the processor saves the SSP register to the SMRAM state save area (see Table 32-3) and clears CR4.CET to 0. Thus, the initial execution environment of the SMI handler has CET disabled and all of the CET state of the interrupted program is still in the machine. An SMM that uses CET is required to save the interrupted program's CET state and restore the CET state prior to exiting SMM.

32.6 EXCEPTIONS AND INTERRUPTS WITHIN SMM

When the processor enters SMM, all hardware interrupts are disabled in the following manner:

- The IF flag in the EFLAGS register is cleared, which inhibits maskable hardware interrupts from being generated.
- The TF flag in the EFLAGS register is cleared, which disables single-step traps.
- Debug register DR7 is cleared, which disables breakpoint traps. (This action prevents a debugger from accidentally breaking into an SMI handler if a debug breakpoint is set in normal address space that overlays code or data in SMRAM.)
- NMI, SMI, and A20M interrupts are blocked by internal SMM logic. (See Section 32.8 for more information about how NMIs are handled in SMM.)

Software-invoked interrupts and exceptions can still occur, and maskable hardware interrupts can be enabled by setting the IF flag. Intel recommends that SMM code be written in so that it does not invoke software interrupts (with the INT *n*, INTO, INT1, INT3, or BOUND instructions) or generate exceptions.

If the SMI handler requires interrupt and exception handling, an SMM interrupt table and the necessary exception and interrupt handlers must be created and initialized from within SMM. Until the interrupt table is correctly initialized (using the LIDT instruction), exceptions and software interrupts will result in unpredictable processor behavior.

The following restrictions apply when designing SMM interrupt and exception-handling facilities:

- The interrupt table should be located at linear address 0 and must contain real-address mode style interrupt vectors (4 bytes containing CS and IP).
- Due to the real-address mode style of base address formation, an interrupt or exception cannot transfer control to a segment with a base address of more than 20 bits.
- An interrupt or exception cannot transfer control to a segment offset of more than 16 bits (64 KBytes).
- When an exception or interrupt occurs, only the 16 least-significant bits of the return address (EIP) are pushed onto the stack. If the offset of the interrupted procedure is greater than 64 KBytes, it is not possible for the interrupt/exception handler to return control to that procedure. (One solution to this problem is for a handler to adjust the return address on the stack.)
- The SMBASE relocation feature affects the way the processor will return from an interrupt or exception generated while the SMI handler is executing. For example, if the SMBASE is relocated to above 1 MByte, but the exception handlers are below 1 MByte, a normal return to the SMI handler is not possible. One solution is to provide the exception handler with a mechanism for calculating a return address above 1 MByte from the 16-bit return address on the stack, then use a 32-bit far call to return to the interrupted procedure.
- If an SMI handler needs access to the debug trap facilities, it must ensure that an SMM accessible debug handler is available and save the current contents of debug registers DR0 through DR3 (for later restoration). Debug registers DR0 through DR3 and DR7 must then be initialized with the appropriate values.
- If an SMI handler needs access to the single-step mechanism, it must ensure that an SMM accessible single-step handler is available, and then set the TF flag in the EFLAGS register.
- If the SMI design requires the processor to respond to maskable hardware interrupts or software-generated interrupts while in SMM, it must ensure that SMM accessible interrupt handlers are available and then set the IF flag in the EFLAGS register (using the STI instruction). Software interrupts are not blocked upon entry to SMM, so they do not need to be enabled.

32.7 MANAGING SYNCHRONOUS AND ASYNCHRONOUS SYSTEM MANAGEMENT INTERRUPTS

When coding for a multiprocessor system or a system with Intel HT Technology, it was not always possible for an SMI handler to distinguish between a synchronous SMI (triggered during an I/O instruction) and an asynchronous SMI. To facilitate the discrimination of these two events, incremental state information has been added to the SMM state save map.

Processors that have an SMM revision ID of 30004H or higher have the incremental state information described below.

32.7.1 I/O State Implementation

Within the extended SMM state save map, a bit (IO_SMI) is provided that is set only when an SMI is either taken immediately after a *successful* I/O instruction or is taken after a *successful* iteration of a REP I/O instruction (the *successful* notion pertains to the processor point of view; not necessarily to the corresponding platform function). When set, the IO_SMI bit provides a strong indication that the corresponding SMI was synchronous. In this case, the SMM State Save Map also supplies the port address of the I/O operation. The IO_SMI bit and the I/O Port Address may be used in conjunction with the information logged by the platform to confirm that the SMI was indeed synchronous.

The IO_SMI bit by itself is a strong indication, not a guarantee, that the SMI is synchronous. This is because an asynchronous SMI might coincidentally be taken after an I/O instruction. In such a case, the IO_SMI bit would still be set in the SMM state save map.

Information characterizing the I/O instruction is saved in two locations in the SMM State Save Map (Table 32-5). The IO_SMI bit also serves as a valid bit for the rest of the I/O information fields. The contents of these I/O information fields are not defined when the IO_SMI bit is not set.

Table 32-5. I/O Instruction Information in the SMM State Save Map

State (SMM Rev. ID: 30004H or higher)	Format								
	31	16	15	8	7	4	3	1	0
I/O State Field SMRAM offset 7FA4		I/O Port	Reserved		I/O Type		I/O Length		IO_SMI
	31								0
I/O Memory Address Field SMRAM offset 7FA0	I/O Memory Address								

When IO_SMI is set, the other fields may be interpreted as follows:

- I/O length:
 - 001 – Byte
 - 010 – Word
 - 100 – Dword
- I/O instruction type (Table 32-6)

Table 32-6. I/O Instruction Type Encodings

Instruction	Encoding
IN Immediate	1001
IN DX	0001
OUT Immediate	1000

Table 32-6. I/O Instruction Type Encodings (Contd.)

Instruction	Encoding
OUT DX	0000
INS	0011
OUTS	0010
REP INS	0111
REP OUTS	0110

32.8 NMI HANDLING WHILE IN SMM

NMI interrupts are blocked upon entry to the SMI handler. If an NMI request occurs during the SMI handler, it is latched and serviced after the processor exits SMM. Only one NMI request will be latched during the SMI handler. If an NMI request is pending when the processor executes the RSM instruction, the NMI is serviced before the next instruction of the interrupted code sequence. This assumes that NMIs were not blocked before the SMI occurred. If NMIs were blocked before the SMI occurred, they are blocked after execution of RSM.

Although NMI requests are blocked when the processor enters SMM, they may be enabled through software by executing an IRET instruction. If the SMI handler requires the use of NMI interrupts, it should invoke a dummy interrupt service routine for the purpose of executing an IRET instruction. Once an IRET instruction is executed, NMI interrupt requests are serviced in the same "real mode" manner in which they are handled outside of SMM.

Also, for the Pentium processor, exceptions that invoke a trap or fault handler will enable NMI interrupts from inside of SMM. This behavior is implementation specific for the Pentium processor and is not part of the IA-32 architecture.

32.9 SMM REVISION IDENTIFIER

The SMM revision identifier field is used to indicate the version of SMM and the SMM extensions that are supported by the processor (see Figure 32-2). The SMM revision identifier is written during SMM entry and can be examined in SMRAM space at offset 7EFCH. The lower word of the SMM revision identifier refers to the version of the base SMM architecture.

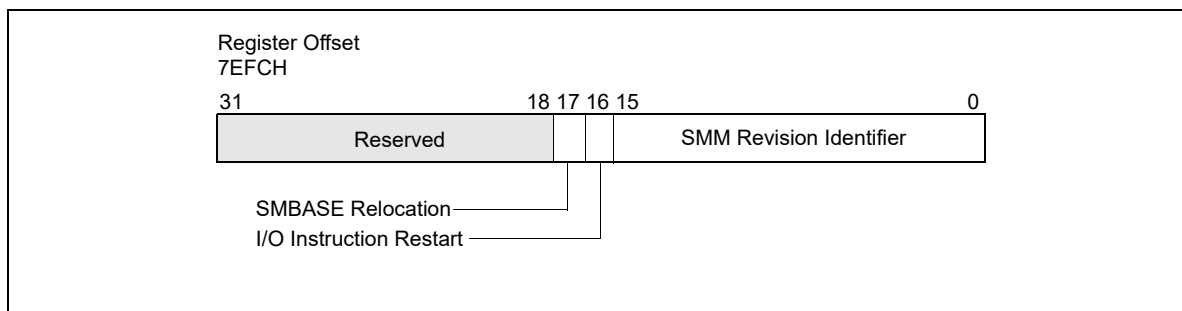

Figure 32-2. SMM Revision Identifier

The upper word of the SMM revision identifier refers to the extensions available. If the I/O instruction restart flag (bit 16) is set, the processor supports the I/O instruction restart (see Section 32.12); if the SMBASE relocation flag (bit 17) is set, SMRAM base address relocation is supported (see Section 32.11).

32.10 AUTO HALT RESTART

If the processor is in a HALT state (due to the prior execution of a HLT instruction) when it receives an SMI, the processor records the fact in the auto HALT restart flag in the saved processor state (see Figure 32-3). (This flag is located at offset 7F02H and bit 0 in the state save area of the SMRAM.)

If the processor sets the auto HALT restart flag upon entering SMM (indicating that the SMI occurred when the processor was in the HALT state), the SMI handler has two options:

- It can leave the auto HALT restart flag set, which instructs the RSM instruction to return program control to the HLT instruction. This option in effect causes the processor to re-enter the HALT state after handling the SMI. (This is the default operation.)
- It can clear the auto HALT restart flag, which instructs the RSM instruction to return program control to the instruction following the HLT instruction.

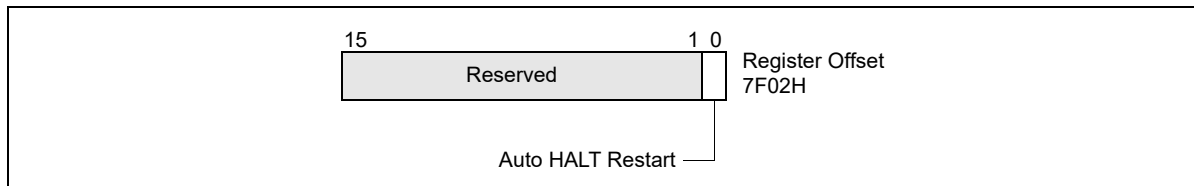

Figure 32-3. Auto HALT Restart Field

These options are summarized in Table 32-7. If the processor was not in a HALT state when the SMI was received (the auto HALT restart flag is cleared), setting the flag to 1 will cause unpredictable behavior when the RSM instruction is executed.

Table 32-7. Auto HALT Restart Flag Values

Value of Flag After Entry to SMM	Value of Flag When Exiting SMM	Action of Processor When Exiting SMM
0	0	Returns to next instruction in interrupted program or task.
0	1	Unpredictable.
1	0	Returns to next instruction after HLT instruction.
1	1	Returns to HALT state.

If the HLT instruction is restarted, the processor will generate a memory access to fetch the HLT instruction (if it is not in the internal cache), and execute a HLT bus transaction. This behavior results in multiple HLT bus transactions for the same HLT instruction.

32.10.1 Executing the HLT Instruction in SMM

The HLT instruction should not be executed during SMM, unless interrupts have been enabled by setting the IF flag in the EFLAGS register. If the processor is halted in SMM, the only event that can remove the processor from this state is a maskable hardware interrupt or a hardware reset.

32.11 SMBASE RELOCATION

The default base address for the SMRAM is 30000H. This value is contained in an internal processor register called the SMBASE register. Software can relocate the SMRAM by setting the SMBASE field in the saved state map (at offset 7EF8H) to a new value (see Figure 32-4). The RSM instruction reloads the internal SMBASE register with the value in the SMBASE field each time it exits SMM. All subsequent SMI requests will use the new SMBASE value to find the starting address for the SMI handler (at SMBASE + 8000H) and the SMRAM state save area (from SMBASE

+ FE00H to SMBASE + FFFFH). (The processor resets the value in its internal SMBASE register to 30000H on a RESET, but does not change it on an INIT.)

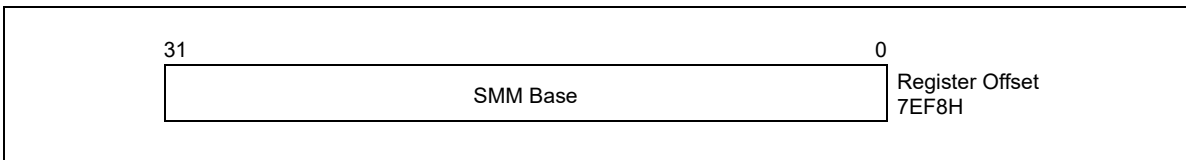

Figure 32-4. SMBASE Relocation Field

In multiple-processor systems, initialization software must adjust the SMBASE value for each processor so that the SMRAM state save areas for each processor do not overlap. (For Pentium and Intel486 processors, the SMBASE values must be aligned on a 32-KByte boundary or the processor will enter shutdown state during the execution of a RSM instruction.)

If the SMBASE relocation flag in the SMM revision identifier field is set, it indicates the ability to relocate the SMBASE (see Section 32.9).

32.12 I/O INSTRUCTION RESTART

If the I/O instruction restart flag in the SMM revision identifier field is set (see Section 32.9), the I/O instruction restart mechanism is present on the processor. This mechanism allows an interrupted I/O instruction to be re-executed upon returning from SMM mode. For example, if an I/O instruction is used to access a powered-down I/O device, a chipset supporting this device can intercept the access and respond by asserting SMI#. This action invokes the SMI handler to power-up the device. Upon returning from the SMI handler, the I/O instruction restart mechanism can be used to re-execute the I/O instruction that caused the SMI.

The I/O instruction restart field (at offset 7F00H in the SMM state-save area, see Figure 32-5) controls I/O instruction restart. When an RSM instruction is executed, if this field contains the value FFH, then the EIP register is modified to point to the I/O instruction that received the SMI request. The processor will then automatically re-execute the I/O instruction that the SMI trapped. (The processor saves the necessary machine state to ensure that re-execution of the instruction is handled coherently.)

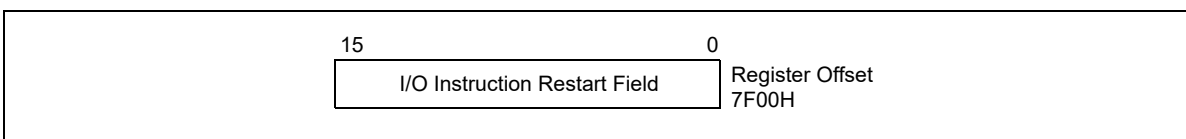

Figure 32-5. I/O Instruction Restart Field

If the I/O instruction restart field contains the value 00H when the RSM instruction is executed, then the processor begins program execution with the instruction following the I/O instruction. (When a repeat prefix is being used, the next instruction may be the next I/O instruction in the repeat loop.) Not re-executing the interrupted I/O instruction is the default behavior; the processor automatically initializes the I/O instruction restart field to 00H upon entering SMM. Table 32-8 summarizes the states of the I/O instruction restart field.

Table 32-8. I/O Instruction Restart Field Values

Value of Flag After Entry to SMM	Value of Flag When Exiting SMM	Action of Processor When Exiting SMM
00H	00H	Does not re-execute trapped I/O instruction.
00H	FFH	Re-executes trapped I/O instruction.

The I/O instruction restart mechanism does not indicate the cause of the SMI. It is the responsibility of the SMI handler to examine the state of the processor to determine the cause of the SMI and to determine if an I/O instruction was interrupted and should be restarted upon exiting SMM. If an SMI interrupt is signaled on a non-I/O instruction boundary, setting the I/O instruction restart field to FFH prior to executing the RSM instruction will likely result in a program error.

32.12.1 Back-to-Back SMI Interrupts When I/O Instruction Restart Is Being Used

If an SMI interrupt is signaled while the processor is servicing an SMI interrupt that occurred on an I/O instruction boundary, the processor will service the new SMI request before restarting the originally interrupted I/O instruction. If the I/O instruction restart field is set to FFH prior to returning from the second SMI handler, the EIP will point to an address different from the originally interrupted I/O instruction, which will likely lead to a program error. To avoid this situation, the SMI handler must be able to recognize the occurrence of back-to-back SMI interrupts when I/O instruction restart is being used and ensure that the handler sets the I/O instruction restart field to 00H prior to returning from the second invocation of the SMI handler.

32.13 SMM MULTIPLE-PROCESSOR CONSIDERATIONS

The following should be noted when designing multiple-processor systems:

- Any processor in a multiprocessor system can respond to an SMI.
- Each processor needs its own SMRAM space. This space can be in system memory or in a separate RAM.
- The SMRAMs for different processors can be overlapped in the same memory space. The only stipulation is that each processor needs its own state save area and its own dynamic data storage area. (Also, for the Pentium and Intel486 processors, the SMBASE address must be located on a 32-KByte boundary.) Code and static data can be shared among processors. Overlapping SMRAM spaces can be done more efficiently with the P6 family processors because they do not require that the SMBASE address be on a 32-KByte boundary.
- The SMI handler will need to initialize the SMBASE for each processor.
- Processors can respond to local SMIs through their SMI# pins or to SMIs received through the APIC interface. The APIC interface can distribute SMIs to different processors.
- Two or more processors can be executing in SMM at the same time.
- When operating Pentium processors in dual processing (DP) mode, the SMIACK# pin is driven only by the MRM processor and should be sampled with ADS#. For additional details, see Chapter 14 of the Pentium Processor Family User's Manual, Volume 1.

SMM is not re-entrant, because the SMRAM State Save Map is fixed relative to the SMBASE. If there is a need to support two or more processors in SMM mode at the same time then each processor should have dedicated SMRAM spaces. This can be done by using the SMBASE Relocation feature (see Section 32.11).

32.14 DEFAULT TREATMENT OF SMIS AND SMM WITH VMX OPERATION AND SMX OPERATION

Under the default treatment, the interactions of SMIs and SMM with VMX operation are few. This section details those interactions. It also explains how this treatment affects SMX operation.

32.14.1 Default Treatment of SMI Delivery

Ordinary SMI delivery saves processor state into SMRAM and then loads state based on architectural definitions. Under the default treatment, processors that support VMX operation perform SMI delivery as follows:

```

enter SMM;
save the following internal to the processor:
    CR4.VMXE
        an indication of whether the logical processor was in VMX operation (root or non-root)
IF the logical processor is in VMX operation
    THEN
        save current VMCS pointer internal to the processor;
        leave VMX operation;
        save VMX-critical state defined below;
FI;
IF the logical processor supports SMX operation
    THEN
        save internal to the logical processor an indication of whether the Intel® TXT private space is locked;
        IF the TXT private space is unlocked
            THEN lock the TXT private space;
        FI;
FI;
CR4.VMXE := 0;
perform ordinary SMI delivery:
    save processor state in SMRAM;
    set processor state to standard SMM values;1
    invalidate linear mappings and combined mappings associated with VPID 0000H (for all PCIDs); combined mappings for VPID 0000H
    are invalidated for all EPTRTA values (EPTRTA is the value of bits 51:12 of EPTP; see Section 29.4);

```

The pseudocode above makes reference to the saving of **VMX-critical state**. This state consists of the following: (1) SS.DPL (the current privilege level); (2) RFLAGS.VM²; (3) the state of blocking by STI and by MOV SS (see Table 25-3 in Section 25.4.2); (4) the state of virtual-NMI blocking (only if the processor is in VMX non-root operation and the “virtual NMIs” VM-execution control is 1); and (5) an indication of whether an MTF VM exit is pending (see Section 26.5.2). These data may be saved internal to the processor or in the VMCS region of the current VMCS. Processors that do not support SMI recognition while there is blocking by STI or by MOV SS need not save the state of such blocking.

If the logical processor supports the 1-setting of the “enable EPT” VM-execution control and the logical processor was in VMX non-root operation at the time of an SMI, it saves the value of that control into bit 0 of the 32-bit field at offset SMBASE + 8000H + 7EE0H (SMBASE + FEE0H; see Table 32-3).³ If the logical processor was not in VMX non-root operation at the time of the SMI, it saves 0 into that bit. If the logical processor saves 1 into that bit (it was in VMX non-root operation and the “enable EPT” VM-execution control was 1), it saves the value of the EPT pointer (EPTP) into the 64-bit field at offset SMBASE + 8000H + 7ED8H (SMBASE + FED8H).

Because SMI delivery causes a logical processor to leave VMX operation, all the controls associated with VMX non-root operation are disabled in SMM and thus cannot cause VM exits while the logical processor in SMM.

-
1. This causes the logical processor to block INIT signals, NMIs, and SMIs.
 2. Section 32.14 and Section 32.15 use the notation RAX, RIP, RSP, RFLAGS, etc. for processor registers because most processors that support VMX operation also support Intel 64 architecture. For processors that do not support Intel 64 architecture, this notation refers to the 32-bit forms of these registers (EAX, EIP, ESP, EFLAGS, etc.). In a few places, notation such as EAX is used to refer specifically to the lower 32 bits of the register.
 3. “Enable EPT” is a secondary processor-based VM-execution control. If bit 31 of the primary processor-based VM-execution controls is 0, SMI functions as the “enable EPT” VM-execution control were 0. See Section 25.6.2.

32.14.2 Default Treatment of RSM

Ordinary execution of RSM restores processor state from SMRAM. Under the default treatment, processors that support VMX operation perform RSM as follows:

```

IF VMXE = 1 in CR4 image in SMRAM
    THEN fail and enter shutdown state;
    ELSE
        restore state normally from SMRAM;
        invalidate linear mappings and combined mappings associated with all VPIDs and all PCIDs; combined mappings are invalidated
        for all EPTRTA values (EPTRTA is the value of bits 51:12 of EPTP; see Section 29.4);
        IF the logical processor supports SMX operation and the Intel® TXT private space was unlocked at the time of the last SMI (as
        saved)
            THEN unlock the TXT private space;
        FI;
        CR4.VMXE := value stored internally;
        IF internal storage indicates that the logical processor
        had been in VMX operation (root or non-root)
            THEN
                enter VMX operation (root or non-root);
                restore VMX-critical state as defined in Section 32.14.1;
                set to their fixed values any bits in CR0 and CR4 whose values must be fixed in VMX operation (see Section 24.8);1
                IF RFLAGS.VM = 0 AND (in VMX root operation OR the “unrestricted guest” VM-execution control is 0)2
                    THEN
                        CS.RPL := SS.DPL;
                        SS.RPL := SS.DPL;
                    FI;
                restore current VMCS pointer;
            FI;
        leave SMM;
        IF logical processor will be in VMX operation or in SMX operation after RSM
            THEN block A20M and leave A20M mode;
        FI;
    FI;

```

RSM unblocks SMIs. It restores the state of blocking by NMI (see Table 25-3 in Section 25.4.2) as follows:

- If the RSM is not to VMX non-root operation or if the “virtual NMIs” VM-execution control will be 0, the state of NMI blocking is restored normally.
- If the RSM is to VMX non-root operation and the “virtual NMIs” VM-execution control will be 1, NMIs are not blocked after RSM. The state of virtual-NMI blocking is restored as part of VMX-critical state.

INIT signals are blocked after RSM if and only if the logical processor will be in VMX root operation.

If RSM returns a logical processor to VMX non-root operation, it re-establishes the controls associated with the current VMCS. If the “interrupt-window exiting” VM-execution control is 1, a VM exit occurs immediately after RSM if the enabling conditions apply. The same is true for the “NMI-window exiting” VM-execution control. Such VM exits occur with their normal priority. See Section 26.2.

If an MTF VM exit was pending at the time of the previous SMI, an MTF VM exit is pending on the instruction boundary following execution of RSM. The following items detail the treatment of MTF VM exits that may be pending following RSM:

1. If the RSM is to VMX non-root operation and both the “unrestricted guest” VM-execution control and bit 31 of the primary processor-based VM-execution controls will be 1, CR0.PE and CR0.PG retain the values that were loaded from SMRAM regardless of what is reported in the capability MSR IA32_VMX_CRO_FIXED0.
2. “Unrestricted guest” is a secondary processor-based VM-execution control. If bit 31 of the primary processor-based VM-execution controls is 0, VM entry functions as if the “unrestricted guest” VM-execution control were 0. See Section 25.6.2.

- System-management interrupts (SMIs), INIT signals, and higher priority events take priority over these MTF VM exits. These MTF VM exits take priority over debug-trap exceptions and lower priority events.
- These MTF VM exits wake the logical processor if RSM caused the logical processor to enter the HLT state (see Section 32.10). They do not occur if the logical processor just entered the shutdown state.

32.14.3 Protection of CR4.VMXE in SMM

Under the default treatment, CR4.VMXE is treated as a reserved bit while a logical processor is in SMM. Any attempt by software running in SMM to set this bit causes a general-protection exception. In addition, software cannot use VMX instructions or enter VMX operation while in SMM.

32.14.4 VMXOFF and SMI Unblocking

The VMXOFF instruction can be executed only with the default treatment (see Section 32.15.1) and only outside SMM. If SMIs are blocked when VMXOFF is executed, VMXOFF unblocks them unless IA32_SMM_MONITOR_CTL[bit 2] is 1 (see Section 32.15.5 for details regarding this MSR).¹ Section 32.15.7 identifies a case in which SMIs may be blocked when VMXOFF is executed.

Not all processors allow this bit to be set to 1. Software should consult the VMX capability MSR IA32_VMX_MISC (see Appendix A.6) to determine whether this is allowed.

32.15 DUAL-MONITOR TREATMENT OF SMIs AND SMM

Dual-monitor treatment is activated through the cooperation of the **executive monitor** (the VMM that operates outside of SMM to provide basic virtualization) and the **SMM-transfer monitor (STM)**; the VMM that operates inside SMM—while in VMX operation—to support system-management functions). Control is transferred to the STM through VM exits; VM entries are used to return from SMM.

The dual-monitor treatment may not be supported by all processors. Software should consult the VMX capability MSR IA32_VMX_BASIC (see Appendix A.1) to determine whether it is supported.

32.15.1 Dual-Monitor Treatment Overview

The dual-monitor treatment uses an executive monitor and an SMM-transfer monitor (STM). Transitions from the executive monitor or its guests to the STM are called **SMM VM exits** and are discussed in Section 32.15.2. SMM VM exits are caused by SMIs as well as executions of VMCALL in VMX root operation. The latter allow the executive monitor to call the STM for service.

The STM runs in VMX root operation and uses VMX instructions to establish a VMCS and perform VM entries to its own guests. This is done all inside SMM (see Section 32.15.3). The STM returns from SMM, not by using the RSM instruction, but by using a VM entry that returns from SMM. Such VM entries are described in Section 32.15.4.

Initially, there is no STM and the default treatment (Section 32.14) is used. The dual-monitor treatment is not used until it is enabled and activated. The steps to do this are described in Section 32.15.5 and Section 32.15.6.

It is not possible to leave VMX operation under the dual-monitor treatment; VMXOFF will fail if executed. The dual-monitor treatment must be deactivated first. The STM deactivates dual-monitor treatment using a VM entry that returns from SMM with the “deactivate dual-monitor treatment” VM-entry control set to 1 (see Section 32.15.7).

The executive monitor configures any VMCS that it uses for VM exits to the executive monitor. SMM VM exits, which transfer control to the STM, use a different VMCS. Under the dual-monitor treatment, each logical processor uses a separate VMCS called the **SMM-transfer VMCS**. When the dual-monitor treatment is active, the logical processor maintains another VMCS pointer called the **SMM-transfer VMCS pointer**. The SMM-transfer VMCS pointer is established when the dual-monitor treatment is activated.

1. Setting IA32_SMM_MONITOR_CTL[bit 2] to 1 prevents VMXOFF from unblocking SMIs regardless of the value of the register’s valid bit (bit 0).

32.15.2 SMM VM Exits

An SMM VM exit is a VM exit that begins outside SMM and that ends in SMM.

Unlike other VM exits, SMM VM exits can begin in VMX root operation. SMM VM exits result from the arrival of an SMI outside SMM or from execution of VMCALL in VMX root operation outside SMM. Execution of VMCALL in VMX root operation causes an SMM VM exit only if the valid bit is set in the IA32_SMM_MONITOR_CTL MSR (see Section 32.15.5).

Execution of VMCALL in VMX root operation causes an SMM VM exit even under the default treatment. This SMM VM exit activates the dual-monitor treatment (see Section 32.15.6).

Differences between SMM VM exits and other VM exits are detailed in Sections 32.15.2.1 through 32.15.2.5. Differences between SMM VM exits that activate the dual-monitor treatment and other SMM VM exits are described in Section 32.15.6.

32.15.2.1 Architectural State Before a VM Exit

System-management interrupts (SMIs) that cause SMM VM exits always do so directly. They do not save state to SMRAM as they do under the default treatment.

32.15.2.2 Updating the Current-VMCS and Executive-VMCS Pointers

SMM VM exits begin by performing the following steps:

1. The executive-VMCS pointer field in the SMM-transfer VMCS is loaded as follows:
 - If the SMM VM exit commenced in VMX non-root operation, it receives the current-VMCS pointer.
 - If the SMM VM exit commenced in VMX root operation, it receives the VMXON pointer.
2. The current-VMCS pointer is loaded with the value of the SMM-transfer VMCS pointer.

The last step ensures that the current VMCS is the SMM-transfer VMCS. VM-exit information is recorded in that VMCS, and VM-entry control fields in that VMCS are updated. State is saved into the guest-state area of that VMCS. The VM-exit controls and host-state area of that VMCS determine how the VM exit operates.

32.15.2.3 Recording VM-Exit Information

SMM VM exits differ from other VM exit with regard to the way they record VM-exit information. The differences follow.

- **Exit reason.**
 - Bits 15:0 of this field contain the basic exit reason. The field is loaded with the reason for the SMM VM exit: I/O SMI (an SMI arrived immediately after retirement of an I/O instruction), other SMI, or VMCALL. See Appendix C, “VMX Basic Exit Reasons.”
 - SMM VM exits are the only VM exits that may occur in VMX root operation. Because the SMM-transfer monitor may need to know whether it was invoked from VMX root or VMX non-root operation, this information is stored in bit 29 of the exit-reason field (see Table 25-18 in Section 25.9.1). The bit is set by SMM VM exits from VMX root operation.
 - If the SMM VM exit occurred in VMX non-root operation and an MTF VM exit was pending, bit 28 of the exit-reason field is set; otherwise, it is cleared.
 - Bits 27:16 and bits 31:30 are cleared.
- **Exit qualification.** For an SMM VM exit due an SMI that arrives immediately after the retirement of an I/O instruction, the exit qualification contains information about the I/O instruction that retired immediately before the SMI. It has the format given in Table 32-9.
- **Guest linear address.** This field is used for VM exits due to SMIs that arrive immediately after the retirement of an INS or OUTS instruction for which the relevant segment (ES for INS; DS for OUTS unless overridden by an instruction prefix) is usable. The field receives the value of the linear address generated by ES:(E)DI (for INS) or segment:(E)SI (for OUTS; the default segment is DS but can be overridden by a segment override

Table 32-9. Exit Qualification for SMIs That Arrive Immediately After the Retirement of an I/O Instruction

Bit Position(s)	Contents
2:0	Size of access: 0 = 1-byte 1 = 2-byte 3 = 4-byte Other values not used.
3	Direction of the attempted access (0 = OUT, 1 = IN)
4	String instruction (0 = not string; 1 = string)
5	REP prefixed (0 = not REP; 1 = REP)
6	Operand encoding (0 = DX, 1 = immediate)
15:7	Reserved (cleared to 0)
31:16	Port number (as specified in the I/O instruction)
63:32	Reserved (cleared to 0). These bits exist only on processors that support Intel 64 architecture.

prefix) at the time the instruction started. If the relevant segment is not usable, the value is undefined. On processors that support Intel 64 architecture, bits 63:32 are clear if the logical processor was not in 64-bit mode before the VM exit.

- **I/O RCX, I/O RSI, I/O RDI, and I/O RIP.** For an SMM VM exit due an SMI that arrives immediately after the retirement of an I/O instruction, these fields receive the values that were in RCX, RSI, RDI, and RIP, respectively, before the I/O instruction executed. Thus, the value saved for I/O RIP addresses the I/O instruction.

32.15.2.4 Saving Guest State

SMM VM exits save the contents of the SMBASE register into the corresponding field in the guest-state area.

The value of the VMX-preemption timer is saved into the corresponding field in the guest-state area if the “save VMX-preemption timer value” VM-exit control is 1. That field becomes undefined if, in addition, either the SMM VM exit is from VMX root operation or the SMM VM exit is from VMX non-root operation and the “activate VMX-preemption timer” VM-execution control is 0.

32.15.2.5 Updating State

If an SMM VM exit is from VMX non-root operation and the “Intel PT uses guest physical addresses” VM-execution control is 1, the IA32_RTIT_CTL MSR is cleared to 00000000_00000000H.¹ This is done even if the “clear IA32_RTIT_CTL” VM-exit control is 0.

SMM VM exits affect the non-register state of a logical processor as follows:

- SMM VM exits cause non-maskable interrupts (NMIs) to be blocked; they may be unblocked through execution of IRET or through a VM entry (depending on the value loaded for the interruptibility state and the setting of the “virtual NMIs” VM-execution control).
- SMM VM exits cause SMIs to be blocked; they may be unblocked by a VM entry that returns from SMM (see Section 32.15.4).

1. In this situation, the value of this MSR was saved earlier into the guest-state area. All VM exits save this MSR if the 1-setting of the “load IA32_RTIT_CTL” VM-entry control is supported (see Section 28.3.1), which must be the case if the “Intel PT uses guest physical addresses” VM-execution control is 1 (see Section 27.2.1.1).

SMM VM exits invalidate linear mappings and combined mappings associated with VPID 0000H for all PCIDs. Combined mappings for VPID 0000H are invalidated for all EPTRTA values (EPTRTA is the value of bits 51:12 of EPTP; see Section 29.4). (Ordinary VM exits are not required to perform such invalidation if the “enable VPID” VM-execution control is 1; see Section 28.5.5.)

32.15.3 Operation of the SMM-Transfer Monitor

Once invoked, the SMM-transfer monitor (STM) is in VMX root operation and can use VMX instructions to configure VMCSs and to cause VM entries to virtual machines supported by those structures. As noted in Section 32.15.1, the VMXOFF instruction cannot be used under the dual-monitor treatment and thus cannot be used by the STM.

The RSM instruction also cannot be used under the dual-monitor treatment. As noted in Section 26.1.3, it causes a VM exit if executed in SMM in VMX non-root operation. If executed in VMX root operation, it causes an invalid-opcode exception. The STM uses VM entries to return from SMM (see Section 32.15.4).

32.15.4 VM Entries that Return from SMM

The SMM-transfer monitor (STM) returns from SMM using a VM entry with the “entry to SMM” VM-entry control clear. VM entries that return from SMM reverse the effects of an SMM VM exit (see Section 32.15.2).

VM entries that return from SMM may differ from other VM entries in that they do not necessarily enter VMX non-root operation. If the executive-VMCS pointer field in the current VMCS contains the VMXON pointer, the logical processor remains in VMX root operation after VM entry.

For differences between VM entries that return from SMM and other VM entries see Sections 32.15.4.1 through 32.15.4.10.

32.15.4.1 Checks on the Executive-VMCS Pointer Field

VM entries that return from SMM perform the following checks on the executive-VMCS pointer field in the current VMCS:

- Bits 11:0 must be 0.
- The pointer must not set any bits beyond the processor’s physical-address width.^{1,2}
- The 32 bits located in memory referenced by the physical address in the pointer must contain the processor’s VMCS revision identifier (see Section 25.2).

The checks above are performed before the checks described in Section 32.15.4.2 and before any of the following checks:

- If the “deactivate dual-monitor treatment” VM-entry control is 0 and the executive-VMCS pointer field does not contain the VMXON pointer, the launch state of the executive VMCS (the VMCS referenced by the executive-VMCS pointer field) must be launched (see Section 25.11.3).
- If the “deactivate dual-monitor treatment” VM-entry control is 1, the executive-VMCS pointer field must contain the VMXON pointer (see Section 32.15.7).³

32.15.4.2 Checks on VM-Execution Control Fields

VM entries that return from SMM differ from other VM entries with regard to the checks performed on the VM-execution control fields specified in Section 27.2.1.1. They do not apply the checks to the current VMCS. Instead, VM-entry behavior depends on whether the executive-VMCS pointer field contains the VMXON pointer:

-
1. Software can determine a processor’s physical-address width by executing CPUID with 80000008H in EAX. The physical-address width is returned in bits 7:0 of EAX.
 2. If IA32_VMX_BASIC[48] is read as 1, this pointer must not set any bits in the range 63:32; see Appendix A.1.
 3. The STM can determine the VMXON pointer by reading the executive-VMCS pointer field in the current VMCS after the SMM VM exit that activates the dual-monitor treatment.

- If the executive-VMCS pointer field contains the VMXON pointer (the VM entry remains in VMX root operation), the checks are not performed at all.
- If the executive-VMCS pointer field does not contain the VMXON pointer (the VM entry enters VMX non-root operation), the checks are performed on the VM-execution control fields in the executive VMCS (the VMCS referenced by the executive-VMCS pointer field in the current VMCS). These checks are performed after checking the executive-VMCS pointer field itself (for proper alignment).

Other VM entries ensure that, if “activate VMX-preemption timer” VM-execution control is 0, the “save VMX-preemption timer value” VM-execution control is also 0. This check is not performed by VM entries that return from SMM.

32.15.4.3 Checks on VM-Entry Control Fields

VM entries that return from SMM differ from other VM entries with regard to the checks performed on the VM-entry control fields specified in Section 27.2.1.3.

Specifically, if the executive-VMCS pointer field contains the VMXON pointer (the VM entry remains in VMX root operation), the VM-entry interruption-information field must not indicate injection of a pending MTF VM exit (see Section 27.6.2). Specifically, the following cannot all be true for that field:

- the valid bit (bit 31) is 1
- the interruption type (bits 10:8) is 7 (other event); and
- the vector (bits 7:0) is 0 (pending MTF VM exit).

32.15.4.4 Checks on the Guest State Area

Section 27.3.1 specifies checks performed on fields in the guest-state area of the VMCS. Some of these checks are conditioned on the settings of certain VM-execution controls (e.g., “virtual NMIs” or “unrestricted guest”).

VM entries that return from SMM modify these checks based on whether the executive-VMCS pointer field contains the VMXON pointer:¹

- If the executive-VMCS pointer field contains the VMXON pointer (the VM entry remains in VMX root operation), the checks are performed as all relevant VM-execution controls were 0. (As a result, some checks may not be performed at all.)
- If the executive-VMCS pointer field does not contain the VMXON pointer (the VM entry enters VMX non-root operation), this check is performed based on the settings of the VM-execution controls in the executive VMCS (the VMCS referenced by the executive-VMCS pointer field in the current VMCS).

For VM entries that return from SMM, the activity-state field must not indicate the wait-for-SIPI state if the executive-VMCS pointer field contains the VMXON pointer (the VM entry is to VMX root operation).

32.15.4.5 Loading Guest State

VM entries that return from SMM load the SMBASE register from the SMBASE field.

VM entries that return from SMM invalidate linear mappings and combined mappings associated with all VPIDs. Combined mappings are invalidated for all EPTRTA values (EPTRTA is the value of bits 51:12 of EPTP; see Section 29.4). (Ordinary VM entries are required to perform such invalidation only for VPID 0000H and are not required to do even that if the “enable VPID” VM-execution control is 1; see Section 27.3.2.5.)

32.15.4.6 VMX-Preemption Timer

A VM entry that returns from SMM activates the VMX-preemption timer only if the executive-VMCS pointer field does not contain the VMXON pointer (the VM entry enters VMX non-root operation) and the “activate VMX-preemption timer” VM-execution control is 1 in the executive VMCS (the VMCS referenced by the executive-VMCS pointer field). In this case, VM entry starts the VMX-preemption timer with the value in the VMX-preemption timer-value field in the current VMCS.

1. The STM can determine the VMXON pointer by reading the executive-VMCS pointer field in the current VMCS after the SMM VM exit that activates the dual-monitor treatment.

32.15.4.7 Updating the Current-VMCS and SMM-Transfer VMCS Pointers

Successful VM entries (returning from SMM) load the SMM-transfer VMCS pointer with the current-VMCS pointer. Following this, they load the current-VMCS pointer from a field in the current VMCS:

- If the executive-VMCS pointer field contains the VMXON pointer (the VM entry remains in VMX root operation), the current-VMCS pointer is loaded from the VMCS-link pointer field.
- If the executive-VMCS pointer field does not contain the VMXON pointer (the VM entry enters VMX non-root operation), the current-VMCS pointer is loaded with the value of the executive-VMCS pointer field.

If the VM entry successfully enters VMX non-root operation, the VM-execution controls in effect after the VM entry are those from the new current VMCS. This includes any structures external to the VMCS referenced by VM-execution control fields.

The updating of these VMCS pointers occurs before event injection. Event injection is determined, however, by the VM-entry control fields in the VMCS that was current when the VM entry commenced.

32.15.4.8 VM Exits Induced by VM Entry

Section 27.6.1.2 describes how the event-delivery process invoked by event injection may lead to a VM exit. Section 27.7.3 to Section 27.7.7 describe other situations that may cause a VM exit to occur immediately after a VM entry.

Whether these VM exits occur is determined by the VM-execution control fields in the current VMCS. For VM entries that return from SMM, they can occur only if the executive-VMCS pointer field does not contain the VMXON pointer (the VM entry enters VMX non-root operation).

In this case, determination is based on the VM-execution control fields in the VMCS that is current after the VM entry. This is the VMCS referenced by the value of the executive-VMCS pointer field at the time of the VM entry (see Section 32.15.4.7). This VMCS also controls the delivery of such VM exits. Thus, VM exits induced by a VM entry returning from SMM are to the executive monitor and not to the STM.

32.15.4.9 SMI Blocking

VM entries that return from SMM determine the blocking of system-management interrupts (SMIs) as follows:

- If the “deactivate dual-monitor treatment” VM-entry control is 0, SMIs are blocked after VM entry if and only if the bit 2 in the interruptibility-state field is 1.
- If the “deactivate dual-monitor treatment” VM-entry control is 1, the blocking of SMIs depends on whether the logical processor is in SMX operation:¹
 - If the logical processor is in SMX operation, SMIs are blocked after VM entry.
 - If the logical processor is outside SMX operation, SMIs are unblocked after VM entry.

VM entries that return from SMM and that do not deactivate the dual-monitor treatment may leave SMIs blocked. This feature exists to allow the STM to invoke functionality outside of SMM without unblocking SMIs.

32.15.4.10 Failures of VM Entries That Return from SMM

Section 27.8 describes the treatment of VM entries that fail during or after loading guest state. Such failures record information in the VM-exit information fields and load processor state as would be done on a VM exit. The VMCS used is the one that was current before the VM entry commenced. Control is thus transferred to the STM and the logical processor remains in SMM.

1. A logical processor is in SMX operation if GETSEC[SEXIT] has not been executed since the last execution of GETSEC[SENDER]. A logical processor is outside SMX operation if GETSEC[SENDER] has not been executed or if GETSEC[SEXIT] was executed after the last execution of GETSEC[SENDER]. See Chapter 7, “Safer Mode Extensions Reference,” in the Intel® 64 and IA-32 Architectures Software Developer’s Manual, Volume 2D.

32.15.5 Enabling the Dual-Monitor Treatment

Code and data for the SMM-transfer monitor (STM) reside in a region of SMRAM called the **monitor segment** (MSEG). Code running in SMM determines the location of MSEG and establishes its content. This code is also responsible for enabling the dual-monitor treatment.

SMM code enables the dual-monitor treatment and specifies the location of MSEG by writing to the IA32_SMM_MONITOR_CTL MSR (index 9BH). The MSR has the following format:

- Bit 0 is the register's valid bit. The STM may be invoked using VMCALL only if this bit is 1. Because VMCALL is used to activate the dual-monitor treatment (see Section 32.15.6), the dual-monitor treatment cannot be activated if the bit is 0. This bit is cleared when the logical processor is reset.
- Bit 1 is reserved.
- Bit 2 determines whether executions of VMXOFF unblock SMIs under the default treatment of SMIs and SMM. Executions of VMXOFF unblock SMIs unless bit 2 is 1 (the value of bit 0 is irrelevant). See Section 32.14.4. Certain leaf functions of the GETSEC instruction clear this bit (see Chapter 7, "Safer Mode Extensions Reference," in the Intel® 64 and IA-32 Architectures Software Developer's Manual, Volume 2D).
- Bits 11:3 are reserved.
- Bits 31:12 contain a value that, when shifted left 12 bits, is the physical address of MSEG (the MSEG base address).
- Bits 63:32 are reserved.

The following items detail use of this MSR:

- The IA32_SMM_MONITOR_CTL MSR is supported only on processors that support the dual-monitor treatment.¹ On other processors, accesses to the MSR using RDMSR or WRMSR generate a general-protection fault (#GP(0)).
- A write to the IA32_SMM_MONITOR_CTL MSR using WRMSR generates a general-protection fault (#GP(0)) if executed outside of SMM or if an attempt is made to set any reserved bit. An attempt to write to the IA32_SMM_MONITOR_CTL MSR fails if made as part of a VM exit that does not end in SMM or part of a VM entry that does not begin in SMM.
- Reads from the IA32_SMM_MONITOR_CTL MSR using RDMSR are allowed any time RDMSR is allowed. The MSR may be read as part of any VM exit.
- The dual-monitor treatment can be activated only if the valid bit in the MSR is set to 1.

The 32 bytes located at the MSEG base address are called the **MSEG header**. The format of the MSEG header is given in Table 32-10 (each field is 32 bits).

Table 32-10. Format of MSEG Header

Byte Offset	Field
0	MSEG-header revision identifier
4	SMM-transfer monitor features
8	GDTR limit
12	GDTR base offset
16	CS selector
20	EIP offset
24	ESP offset
28	CR3 offset

1. Software should consult the VMX capability MSR IA32_VMX_BASIC (see Appendix A.1) to determine whether the dual-monitor treatment is supported.

To ensure proper behavior in VMX operation, software should maintain the MSEG header in writeback cacheable memory. Future implementations may allow or require a different memory type.¹ Software should consult the VMX capability MSR IA32_VMX_BASIC (see Appendix A.1).

SMM code should enable the dual-monitor treatment (by setting the valid bit in IA32_SMM_MONITOR_CTL MSR) only after establishing the content of the MSEG header as follows:

- Bytes 3:0 contain the **MSEG revision identifier**. Different processors may use different MSEG revision identifiers. These identifiers enable software to avoid using an MSEG header formatted for one processor on a processor that uses a different format. Software can discover the MSEG revision identifier that a processor uses by reading the VMX capability MSR IA32_VMX_MISC (see Appendix A.6).
- Bytes 7:4 contain the **SMM-transfer monitor features** field. Bits 31:1 of this field are reserved and must be zero. Bit 0 of the field is the **IA-32e mode SMM feature bit**. It indicates whether the logical processor will be in IA-32e mode after the STM is activated (see Section 32.15.6).
- Bytes 31:8 contain fields that determine how processor state is loaded when the STM is activated (see Section 32.15.6.5). SMM code should establish these fields so that activating of the STM invokes the STM's initialization code.

32.15.6 Activating the Dual-Monitor Treatment

The dual-monitor treatment may be enabled by SMM code as described in Section 32.15.5. The dual-monitor treatment is activated only if it is enabled and only by the executive monitor. The executive monitor activates the dual-monitor treatment by executing VMCALL in VMX root operation.

When VMCALL activates the dual-monitor treatment, it causes an SMM VM exit. Differences between this SMM VM exit and other SMM VM exits are discussed in Sections 32.15.6.1 through 32.15.6.6. See also "VMCALL—Call to VM Monitor" in Chapter 31.

32.15.6.1 Initial Checks

An execution of VMCALL attempts to activate the dual-monitor treatment if (1) the processor supports the dual-monitor treatment;² (2) the logical processor is in VMX root operation; (3) the logical processor is outside SMM and the valid bit is set in the IA32_SMM_MONITOR_CTL MSR; (4) the logical processor is not in virtual-8086 mode and not in compatibility mode; (5) CPL = 0; and (6) the dual-monitor treatment is not active.

Such an execution of VMCALL begins with some initial checks. These checks are performed before updating the current-VMCS pointer and the executive-VMCS pointer field (see Section 32.15.2.2).

The VMCS that manages SMM VM exit caused by this VMCALL is the current VMCS established by the executive monitor. The VMCALL performs the following checks on the current VMCS in the order indicated:

1. There must be a current VMCS pointer.
2. The launch state of the current VMCS must be clear.
3. The VM-exit controls in the current VMCS must be set properly:
 - Reserved bits in the primary VM-exit controls must be set properly. Software may consult the VMX capability MSRs to determine the proper setting (see Appendix A.4.1).
 - If the "activate secondary controls" primary VM-exit control is 1, reserved bits in the secondary VM-exit controls must be cleared. Software may consult the VMX capability MSRs to determine which bits are reserved (see Appendix A.4.2).

1. Alternatively, software may map the MSEG header with the UC memory type; this may be necessary, depending on how memory is organized. Doing so is strongly discouraged unless necessary as it will cause the performance of transitions using those structures to suffer significantly. In addition, the processor will continue to use the memory type reported in the VMX capability MSR IA32_VMX_BASIC with exceptions noted in Appendix A.1.

2. Software should consult the VMX capability MSR IA32_VMX_BASIC (see Appendix A.1) to determine whether the dual-monitor treatment is supported.

- If the “activate secondary controls” primary VM-exit control is 0 (or if the processor does not support the 1-setting of that control), no checks are performed on the secondary VM-exit controls. The logical processor operates as if all the secondary VM-exit controls were 0.

If any of these checks fail, subsequent checks are skipped and VMCALL fails. If all these checks succeed, the logical processor uses the IA32_SMM_MONITOR_CTL MSR to determine the base address of MSEG. The following checks are performed in the order indicated:

1. The logical processor reads the 32 bits at the base of MSEG and compares them to the processor’s MSEG revision identifier.
2. The logical processor reads the SMM-transfer monitor features field:
 - Bit 0 of the field is the IA-32e mode SMM feature bit, and it indicates whether the logical processor will be in IA-32e mode after the SMM-transfer monitor (STM) is activated.
 - If the VMCALL is executed on a processor that does not support Intel 64 architecture, the IA-32e mode SMM feature bit must be 0.
 - If the VMCALL is executed in 64-bit mode, the IA-32e mode SMM feature bit must be 1.
 - Bits 31:1 of this field are currently reserved and must be zero.

If any of these checks fail, subsequent checks are skipped and the VMCALL fails.

32.15.6.2 Updating the Current-VMCS and Executive-VMCS Pointers

Before performing the steps in Section 32.15.2.2, SMM VM exits that activate the dual-monitor treatment begin by loading the SMM-transfer VMCS pointer with the value of the current-VMCS pointer.

32.15.6.3 Saving Guest State

As noted in Section 32.15.2.4, SMM VM exits save the contents of the SMBASE register into the corresponding field in the guest-state area. While this is true also for SMM VM exits that activate the dual-monitor treatment, the VMCS used for those VM exits exists outside SMRAM.

The SMM-transfer monitor (STM) can also discover the current value of the SMBASE register by using the RDMSR instruction to read the IA32_SMBASE MSR (MSR address 9EH). The following items detail use of this MSR:

- The MSR is supported only if IA32_VMX_MISC[15] = 1 (see Appendix A.6).
- A write to the IA32_SMBASE MSR using WRMSR generates a general-protection fault (#GP(0)). An attempt to write to the IA32_SMBASE MSR fails if made as part of a VM exit or part of a VM entry.
- A read from the IA32_SMBASE MSR using RDMSR generates a general-protection fault (#GP(0)) if executed outside of SMM. An attempt to read from the IA32_SMBASE MSR fails if made as part of a VM exit that does not end in SMM.

32.15.6.4 Saving MSRs

The VM-exit MSR-store area is not used by SMM VM exits that activate the dual-monitor treatment. No MSRs are saved into that area.

32.15.6.5 Loading Host State

The VMCS that is current during an SMM VM exit that activates the dual-monitor treatment was established by the executive monitor. It does not contain the VM-exit controls and host state required to initialize the STM. For this reason, such SMM VM exits do not load processor state as described in Section 28.5. Instead, state is set to fixed values or loaded based on the content of the MSEG header (see Table 32-10):

- CR0 is set to as follows:
 - PG, NE, ET, MP, and PE are all set to 1.
 - CD and NW are left unchanged.

- All other bits are cleared to 0.
- CR3 is set as follows:
 - Bits 63:32 are cleared on processors that support IA-32e mode.
 - Bits 31:12 are set to bits 31:12 of the sum of the MSEG base address and the CR3-offset field in the MSEG header.
 - Bits 11:5 and bits 2:0 are cleared (the corresponding bits in the CR3-offset field in the MSEG header are ignored).
 - Bits 4:3 are set to bits 4:3 of the CR3-offset field in the MSEG header.
- CR4 is set as follows:
 - MCE, PGE, CET, and PCIDE are cleared.
 - PAE is set to the value of the IA-32e mode SMM feature bit.
 - If the IA-32e mode SMM feature bit is clear, PSE is set to 1 if supported by the processor; if the bit is set, PSE is cleared.
 - All other bits are unchanged.
- DR7 is set to 400H.
- The IA32_DEBUGCTL MSR is cleared to 00000000_00000000H.
- The registers CS, SS, DS, ES, FS, and GS are loaded as follows:
 - All registers are usable.
 - CS.selector is loaded from the corresponding field in the MSEG header (the high 16 bits are ignored), with bits 2:0 cleared to 0. If the result is 0000H, CS.selector is set to 0008H.
 - The selectors for SS, DS, ES, FS, and GS are set to CS.selector+0008H. If the result is 0000H (if the CS selector was FFF8H), these selectors are instead set to 0008H.
 - The base addresses of all registers are cleared to zero.
 - The segment limits for all registers are set to FFFFFFFFH.
 - The AR bytes for the registers are set as follows:
 - CS.Type is set to 11 (execute/read, accessed, non-conforming code segment).
 - For SS, DS, ES, FS, and GS, the Type is set to 3 (read/write, accessed, expand-up data segment).
 - The S bits for all registers are set to 1.
 - The DPL for each register is set to 0.
 - The P bits for all registers are set to 1.
 - On processors that support Intel 64 architecture, CS.L is loaded with the value of the IA-32e mode SMM feature bit.
 - CS.D is loaded with the inverse of the value of the IA-32e mode SMM feature bit.
 - For each of SS, DS, ES, FS, and GS, the D/B bit is set to 1.
 - The G bits for all registers are set to 1.
- LDTR is unusable. The LDTR selector is cleared to 0000H, and the register is otherwise undefined (although the base address is always canonical)
- GDTR.base is set to the sum of the MSEG base address and the GDTR base-offset field in the MSEG header (bits 63:32 are always cleared on processors that support IA-32e mode). GDTR.limit is set to the corresponding field in the MSEG header (the high 16 bits are ignored).
- IDTR.base is unchanged. IDTR.limit is cleared to 0000H.
- RIP is set to the sum of the MSEG base address and the value of the RIP-offset field in the MSEG header (bits 63:32 are always cleared on logical processors that support IA-32e mode).
- RSP is set to the sum of the MSEG base address and the value of the RSP-offset field in the MSEG header (bits 63:32 are always cleared on logical processor that supports IA-32e mode).

- RFLAGS is cleared, except bit 1, which is always set.
- The logical processor is left in the active state.
- Event blocking after the SMM VM exit is as follows:
 - There is no blocking by STI or by MOV SS.
 - There is blocking by non-maskable interrupts (NMIs) and by SMIs.
- There are no pending debug exceptions after the SMM VM exit.
- For processors that support IA-32e mode, the IA32_EFER MSR is modified so that LME and LMA both contain the value of the IA-32e mode SMM feature bit.

If any of CR3[63:5], CR4.PAE, CR4.PSE, or IA32_EFER.LMA is changing, the TLBs are updated so that, after VM exit, the logical processor does not use translations that were cached before the transition. This is not necessary for changes that would not affect paging due to the settings of other bits (for example, changes to CR4.PSE if IA32_EFER.LMA was 1 before and after the transition).

32.15.6.6 Loading MSRs

The VM-exit MSR-load area is not used by SMM VM exits that activate the dual-monitor treatment. No MSRs are loaded from that area.

32.15.7 Deactivating the Dual-Monitor Treatment

The SMM-transfer monitor may deactivate the dual-monitor treatment and return the processor to default treatment of SMIs and SMM (see Section 32.14). It does this by executing a VM entry with the “deactivate dual-monitor treatment” VM-entry control set to 1.

As noted in Section 27.2.1.3 and Section 32.15.4.1, an attempt to deactivate the dual-monitor treatment fails in the following situations: (1) the processor is not in SMM; (2) the “entry to SMM” VM-entry control is 1; or (3) the executive-VMCS pointer does not contain the VMXON pointer (the VM entry is to VMX non-root operation).

As noted in Section 32.15.4.9, VM entries that deactivate the dual-monitor treatment ignore the SMI bit in the interruptibility-state field of the guest-state area. Instead, the blocking of SMIs following such a VM entry depends on whether the logical processor is in SMX operation:¹

- If the logical processor is in SMX operation, SMIs are blocked after VM entry. SMIs may later be unblocked by the VMXOFF instruction (see Section 32.14.4) or by certain leaf functions of the GETSEC instruction (see Chapter 7, “Safer Mode Extensions Reference,” in the Intel® 64 and IA-32 Architectures Software Developer’s Manual, Volume 2D).
- If the logical processor is outside SMX operation, SMIs are unblocked after VM entry.

32.16 SMI AND PROCESSOR EXTENDED STATE MANAGEMENT

On processors that support processor extended states using XSAVE/XRSTOR (see Chapter 13, “Managing State Using the XSAVE Feature Set,” of the Intel® 64 and IA-32 Architectures Software Developer’s Manual, Volume 1), the processor does not save any XSAVE/XRSTOR related state on an SMI. It is the responsibility of the SMI handler code to properly preserve the state information (including CR4.OSXSAVE, XCR0, and possibly processor extended states using XSAVE/XRSTOR). Therefore, the SMI handler must follow the rules described in Chapter 13, “Managing State Using the XSAVE Feature Set,” of the Intel® 64 and IA-32 Architectures Software Developer’s Manual, Volume 1.

1. A logical processor is in SMX operation if GETSEC[SEXIT] has not been executed since the last execution of GETSEC[SENTER]. A logical processor is outside SMX operation if GETSEC[SENTER] has not been executed or if GETSEC[SEXIT] was executed after the last execution of GETSEC[SENTER]. See Chapter 7, “Safer Mode Extensions Reference,” in the Intel® 64 and IA-32 Architectures Software Developer’s Manual, Volume 2D.

32.17 MODEL-SPECIFIC SYSTEM MANAGEMENT ENHANCEMENT

This section describes enhancement of system management features that apply only to the 4th generation Intel Core processors. These features are model-specific. BIOS and SMM handler must use CPUID to enumerate Display-Family_DisplayModel signature when programming with these interfaces.

32.17.1 SMM Handler Code Access Control

The BIOS may choose to restrict the address ranges of code that SMM handler executes. When SMM handler code execution check is enabled, an attempt by the SMM handler to execute outside the ranges specified by SMRR (see Section 32.4.2.1) will cause the assertion of an unrecoverable machine check exception (MCE).

The interface to enable SMM handler code access check resides in a per-package scope model-specific register MSR_SMM_FEATURE_CONTROL at address 4E0H. An attempt to access MSR_SMM_FEATURE_CONTROL outside of SMM will cause a #GP. Writes to MSR_SMM_FEATURE_CONTROL is further protected by configuration interface of MSR_SMM_MCA_CAP at address 17DH.

Details of the interface of MSR_SMM_FEATURE_CONTROL and MSR_SMM_MCA_CAP are described in Table 2-29 in Chapter 2, "Model-Specific Registers (MSRs)," of the Intel® 64 and IA-32 Architectures Software Developer's Manual, Volume 4.

32.17.2 SMI Delivery Delay Reporting

Entry into the system management mode occurs at instruction boundary. In situations where a logical processor is executing an instruction involving a long flow of internal operations, servicing an SMI by that logical processor will be delayed. Delayed servicing of SMI of each logical processor due to executing long flows of internal operation in a physical processor can be queried via a package-scope register MSR_SMM_DELAYED at address 4E2H.

The interface to enable reporting of SMI delivery delay due to long internal flows resides in a per-package scope model-specific register MSR_SMM_DELAYED. An attempt to access MSR_SMM_DELAYED outside of SMM will cause a #GP. Availability to MSR_SMM_DELAYED is protected by configuration interface of MSR_SMM_MCA_CAP at address 17DH.

Details of the interface of MSR_SMM_DELAYED and MSR_SMM_MCA_CAP are described in Table 2-29 in Chapter 2, "Model-Specific Registers (MSRs)," of the Intel® 64 and IA-32 Architectures Software Developer's Manual, Volume 4.

32.17.3 Blocked SMI Reporting

A logical processor may have entered into a state and blocked from servicing other interrupts (including SMI). Logical processors in a physical processor that are blocked in servicing SMI can be queried in a package-scope register MSR_SMM_BLOCKED at address 4E3H. An attempt to access MSR_SMM_BLOCKED outside of SMM will cause a #GP.

Details of the interface of MSR_SMM_BLOCKED is described in Table 2-29 in Chapter 2, "Model-Specific Registers (MSRs)," of the Intel® 64 and IA-32 Architectures Software Developer's Manual, Volume 4.

CHAPTER 33

INTEL® PROCESSOR TRACE

33.1 OVERVIEW

Intel® Processor Trace (**Intel PT**) is an extension of Intel® Architecture that captures information about software execution using dedicated hardware facilities that cause only minimal performance perturbation to the software being traced. This information is collected in **data packets**. The initial implementations of Intel PT offer **control flow tracing**, which generates a variety of packets to be processed by a software decoder. The packets include timing, program flow information (e.g., branch targets, branch taken/not taken indications) and program-induced mode related information (e.g., Intel TSX state transitions, CR3 changes). These packets may be buffered internally before being sent to the memory subsystem or other output mechanism available in the platform. Debug software can process the trace data and reconstruct the program flow.

Intel Processor Trace was first introduced in Intel® processors based on Broadwell microarchitecture and Intel Atom® processors based on Goldmont microarchitecture. Later generations include additional trace sources, including software trace instrumentation using PTWRITE, and Power Event tracing.

33.1.1 Features and Capabilities

Intel PT's control flow trace generates a variety of packets that, when combined with the binaries of a program by a post-processing tool, can be used to produce an exact execution trace. The packets record flow information such as instruction pointers (IP), indirect branch targets, and directions of conditional branches within contiguous code regions (basic blocks).

Intel PT can also be configured to log software-generated packets using PTWRITE, and packets describing processor power management events. Further, Precise Event-Based Sampling (PEBS) can be configured to log PEBS records in the Intel PT trace; see Section 20.5.5.2.

In addition, the packets record other contextual, timing, and bookkeeping information that enables both functional and performance debugging of applications. Intel PT has several control and filtering capabilities available to customize the tracing information collected and to append other processor state and timing information to enable debugging. For example, there are modes that allow packets to be filtered based on the current privilege level (CPL) or the value of CR3.

Configuration of the packet generation and filtering capabilities are programmed via a set of MSRs. The MSRs generally follow the naming convention of IA32_RTIT_*. The capability provided by these configuration MSRs are enumerated by CPUID, see Section 33.3. Details of the MSRs for configuring Intel PT are described in Section 33.2.8.

33.1.1.1 Packet Summary

After a tracing tool has enabled and configured the appropriate MSRs, the processor will collect and generate trace information in the following categories of packets (for more details on the packets, see Section 33.4):

- Packets about basic information on program execution; these include:
 - Packet Stream Boundary (PSB) packets: PSB packets act as 'heartbeats' that are generated at regular intervals (e.g., every 4K trace packet bytes). These packets allow the packet decoder to find the packet boundaries within the output data stream; a PSB packet should be the first packet that a decoder looks for when beginning to decode a trace.
 - Paging Information Packet (PIP): PIPs record modifications made to the CR3 register. This information, along with information from the operating system on the CR3 value of each process, allows the debugger to attribute linear addresses to their correct application source.
 - Time-Stamp Counter (TSC) packets: TSC packets aid in tracking wall-clock time, and contain some portion of the software-visible time-stamp counter.
 - Core Bus Ratio (CBR) packets: CBR packets contain the core:bus clock ratio.

- Mini Time Counter (MTC) packets: MTC packets provide periodic indication of the passing of wall-clock time.
- Cycle Count (CYC) packets: CYC packets provide indication of the number of processor core clock cycles that pass between packets.
- Overflow (OVF) packets: OVF packets are sent when the processor experiences an internal buffer overflow, resulting in packets being dropped. This packet notifies the decoder of the loss and can help the decoder to respond to this situation.
- Packets about control flow information:
 - Taken Not-Taken (TNT) packets: TNT packets track the “direction” of direct conditional branches (taken or not taken).
 - Target IP (TIP) packets: TIP packets record the target IP of indirect branches, exceptions, interrupts, and other branches or events. These packets can contain the IP, although that IP value may be compressed by eliminating upper bytes that match the last IP. There are various types of TIP packets; they are covered in more detail in Section 33.4.2.2.
 - Flow Update Packets (FUP): FUPs provide the source IP addresses for asynchronous events (interrupt and exceptions), as well as other cases where the source address cannot be determined from the binary.
 - MODE packets: These packets provide the decoder with important processor execution information so that it can properly interpret the dis-assembled binary and trace log. MODE packets have a variety of formats that indicate details such as the execution mode (16-bit, 32-bit, or 64-bit).
- Packets inserted by software:
 - PTWRITE (PTW) packets: includes the value of the operand passed to the PTWRITE instruction (see “PTWRITE—Write Data to a Processor Trace Packet” in the Intel® 64 and IA-32 Architectures Software Developer’s Manual, Volume 2B).
- Packets about processor power management events:
 - MWAIT packets: Indicate successful completion of an MWAIT operation to a C-state deeper than C0.0.
 - Power State Entry (PWRE) packets: Indicate entry to a C-state deeper than C0.0.
 - Power State Exit (PWRX) packets: Indicate exit from a C-state deeper than C0.0, returning to C0.
 - Execution Stopped (EXSTOP) packets: Indicate that software execution has stopped, due to events such as P-state change, C-state change, or thermal throttling.
- Packets containing groups of processor state values:
 - Block Begin Packets (BBP): Indicate the type of state held in the following group.
 - Block Item Packets (BIP): Indicate the state values held in the group.
 - Block End Packets (BEP): Indicate the end of the current group.

33.2 INTEL® PROCESSOR TRACE OPERATIONAL MODEL

This section describes the overall Intel Processor Trace mechanism and the essential concepts relevant to how it operates.

33.2.1 Change of Flow Instruction (COFI) Tracing

A basic program block is a section of code where no jumps or branches occur. The instruction pointers (IPs) in this block of code need not be traced, as the processor will execute them from start to end without redirecting code flow. Instructions such as branches, and events such as exceptions or interrupts, can change the program flow. These instructions and events that change program flow are called Change of Flow Instructions (COFI). There are three categories of COFI:

- Direct transfer COFI.
- Indirect transfer COFI.
- Far transfer COFI.

The following subsections describe the COFI events that result in trace packet generation. Table 33-1 lists branch instruction by COFI types. For detailed description of specific instructions, see the Intel® 64 and IA-32 Architectures Software Developer's Manual.

Table 33-1. COFI Type for Branch Instructions

COFI Type	Instructions
Conditional Branch	JA, JAE, JB, JBE, JC, JCXZ, JECXZ, JRCXZ, JE, JG, JGE, JL, JLE, JNA, JNAE, JNB, JNBE, JNC, JNE, JNG, JNGE, JNL, JNLE, JNO, JNP, JNS, JNZ, JO, JP, JPE, JPO, JS, JZ, LOOP, LOOPE, LOOPNE, LOOPNZ, LOOPZ
Unconditional Direct Branch	JMP (E9 xx, EB xx), CALL (E8 xx)
Indirect Branch	JMP (FF /4), CALL (FF /2), RET (C3, C2 xx)
Far Transfers	INT1, INT3, INT <i>n</i> , INTO, IRET, IRETD, IRETQ, JMP (EA xx, FF /5), CALL (9A xx, FF /3), RET (CB, CA xx), SYSCALL, SYSRET, SYSENTER, SYSEXIT, VMLAUNCH, VMRESUME

33.2.1.1 Direct Transfer COFI

Direct Transfer COFI are relative branches. This means that their target is an IP whose offset from the current IP is embedded in the instruction bytes. It is not necessary to indicate target of these instructions in the trace output since it can be obtained through the source disassembly. Conditional branches need to indicate only whether the branch is taken or not. Unconditional branches do not need any recording in the trace output. There are two sub-categories:

- **Conditional Branch (Jcc, J*CXZ) and LOOP**

To track this type of instruction, the processor encodes a single bit (taken or not taken — TNT) to indicate the program flow after the instruction.

Jcc, J*CXZ, and LOOP can be traced with TNT bits. To improve the trace packet output efficiency, the processor will compact several TNT bits into a single packet.

- **Unconditional Direct Jumps**

There is no trace output required for direct unconditional jumps (like JMP near relative or CALL near relative) since they can be directly inferred from the application assembly. Direct unconditional jumps do not generate a TNT bit or a Target IP packet, though TIP.PGD and TIP.PGE packets can be generated by unconditional direct jumps that toggle Intel PT enables (see Section 33.2.6).

33.2.1.2 Indirect Transfer COFI

Indirect transfer instructions involve updating the IP from a register or memory location. Since the register or memory contents can vary at any time during execution, there is no way to know the target of the indirect transfer until the register or memory contents are read. As a result, the disassembled code is not sufficient to determine the target of this type of COFI. Therefore, tracing hardware must send out the destination IP in the trace packet for debug software to determine the target address of the COFI. Note that this IP may be a linear or effective address (see Section 33.3.1.1).

An indirect transfer instruction generates a Target IP Packet (TIP) that contains the target address of the branch. There are two sub-categories:

- **Near JMP Indirect and Near Call Indirect**

As previously mentioned, the target of an indirect COFI resides in the contents of either a register or memory location. Therefore, the processor must generate a packet that includes this target address to allow the decoder to determine the program flow.

- **Near RET**

When a CALL instruction executes, it pushes onto the stack the address of the next instruction following the CALL. Upon completion of the call procedure, the RET instruction is often used to pop the return address off of the call stack and redirect code flow back to the instruction following the CALL.

A RET instruction simply transfers program flow to the address it popped off the stack. Because a called procedure may change the return address on the stack before executing the RET instruction, debug software

can be misled if it assumes that code flow will return to the instruction following the last CALL. Therefore, even for near RET, a Target IP Packet may be sent.

— RET Compression

A special case is applied if the target of the RET is consistent with what would be expected from tracking the CALL stack. If it is assured that the decoder has seen the corresponding CALL (with “corresponding” defined as the CALL with matching stack depth), and the RET target is the instruction after that CALL, the RET target may be “compressed”. In this case, only a single TNT bit of “taken” is generated instead of a Target IP Packet. To ensure that the decoder will not be confused in cases of RET compression, only RETs that correspond to CALLs which have been seen since the last PSB packet may be compressed in a given logical processor. For details, see “Indirect Transfer Compression for Returns (RET)” in Section 33.4.2.2.

33.2.1.3 Far Transfer COFI

All operations that change the instruction pointer and are not near jumps are “far transfers”. This includes exceptions, interrupts, traps, TSX aborts, and instructions that do far transfers.

All far transfers will produce a Target IP (TIP) packet, which provides the destination IP address. For those far transfers that cannot be inferred from the binary source (e.g., asynchronous events such as exceptions and interrupts), the TIP will be preceded by a Flow Update packet (FUP), which provides the source IP address at which the event was taken. Table 33-23 indicates exactly which IP will be included in the FUP generated by a far transfer.

33.2.2 Software Trace Instrumentation with PTWRITE

PTWRITE provides a mechanism by which software can instrument the Intel PT trace. PTWRITE is a ring3-accessible instruction that can be passed to a register or memory variable, see “PTWRITE—Write Data to a Processor Trace Packet” in the Intel® 64 and IA-32 Architectures Software Developer’s Manual, Volume 2B, for details. The contents of that variable will be used as the payload for the PTW packet (see Table 33-40 “PTW Packet Definition”), inserted at the time of PTWRITE retirement, assuming PTWRITE is enabled and all other filtering conditions are met. Decode and analysis software will then be able to determine the meaning of the PTWRITE packet based on the IP of the associated PTWRITE instruction.

PTWRITE is enabled via IA32_RTIT_CTL.PTWEn[12] (see Table 33-6). Optionally, the user can use IA32_RTIT_CTL.FUPonPTW[5] to enable PTW packets to be followed by FUP packets containing the IP of the associated PTWRITE instruction. Support for PTWRITE is introduced in Intel Atom processors based on the Goldmont Plus microarchitecture.

33.2.3 Power Event Tracing

Power Event Trace is a capability that exposes core- and thread-level sleep state and power down transition information. When this capability is enabled, the trace will expose information about:

- Scenarios where software execution stops.
 - Due to sleep state entry, frequency change, or other powerdown.
 - Includes the IP, when in the tracing context.
- The requested and resolved hardware thread C-state.
 - Including indication of hardware autonomous C-state entry.
- The last and deepest core C-state achieved during a sleep session.
- The reason for C-state wake.

This information is in addition to the bus ratio (CBR) information provided by default after any powerdown, and the timing information (TSC, TMA, MTC, CYC) provided during or after a powerdown state.

Power Event Trace is enabled via IA32_RTIT_CTL.PwrEvtEn[4]. Support for Power Event Tracing is introduced in Intel Atom processors based on the Goldmont Plus microarchitecture.

33.2.4 Event Tracing

Event Trace is a capability that exposes details about the asynchronous events, when they are generated, and when their corresponding software event handler completes execution. These include:

- Interrupts, including NMI and SMI, including the interrupt vector when defined.
- Faults, exceptions including the fault vector.
 - Page faults additionally include the page fault address, when in context.
- Event handler returns, including IRET and RSM.
- VM exits and VM entries.¹
 - VM exits include the values written to the “exit reason” and “exit qualification” VMCS fields.
- INIT and SIPI events.
- TSX aborts, including the abort status returned for the RTM instructions.
- Shutdown.

Additionally, it provides indication of the status of the Interrupt Flag (IF), to indicate when interrupts are masked.

Event Trace is enabled via IA32_RTIT_CTL.EventEn[31]. Event Trace information is conveyed in Control Flow Event (CFE) and Event Data (EVD) packets, as well as the legacy MODE.Exec packet. See Section 33.4.2 for packet details. Support for Event Trace is introduced in Intel® processors based on Gracemont microarchitecture.

33.2.5 Trace Filtering

Intel Processor Trace provides filtering capabilities, by which the debug/profile tool can control what code is traced.

33.2.5.1 Filtering by Current Privilege Level (CPL)

Intel PT provides the ability to configure a logical processor to generate trace packets only when CPL = 0, when CPL > 0, or regardless of CPL.

CPL filtering ensures that no IPs or other architectural state information associated with the filtered CPL can be seen in the log. For example, if the processor is configured to trace only when CPL > 0, and software executes SYSCALL (changing the CPL to 0), the destination IP of the SYSCALL will be suppressed from the generated packet (see the discussion of TIP.PGD in Section 33.4.2.5).

It should be noted that CPL is always 0 in real-address mode and that CPL is always 3 in virtual-8086 mode. To trace code in these modes, filtering should be configured accordingly.

When software is executing in a non-enabled CPL, ContextEn is cleared. See Section 33.2.6.1 for details.

33.2.5.2 Filtering by CR3

Intel PT supports a CR3-filtering mechanism by which the generation of packets containing architectural states can be enabled or disabled based on the value of CR3. A debugger can use CR3 filtering to trace only a single application without context switching the state of the RTIT MSRs. For the reconstruction of traces from software with multiple threads, debug software may wish to context-switch for the state of the RTIT MSRs (if the operating system does not provide context-switch support) to separate the output for the different threads (see Section 33.3.5, “Context Switch Consideration”).

To trace for only a single CR3 value, software can write that value to the IA32_RTIT_CR3_MATCH MSR, and set IA32_RTIT_CTL.CR3Filter. When CR3 value does not match IA32_RTIT_CR3_MATCH and IA32_RTIT_CTL.CR3Filter is 1, ContextEn is forced to 0, and packets containing architectural states will not be generated. Some other packets can be generated when ContextEn is 0; see Section 33.2.6.3 for details. When CR3 does match IA32_RTIT_CR3_MATCH (or when IA32_RTIT_CTL.CR3Filter is 0), CR3 filtering does not force ContextEn to 0 (although it could be 0 due to other filters or modes).

1. Logging of VMX transitions depends on VMCS configuration, see Section 33.5.1.

CR3 matches IA32_RTIT_CR3_MATCH if the two registers are identical for bits 63:12, or 63:5 when in PAE paging mode; the lower 5 bits of CR3 and IA32_RTIT_CR3_MATCH are ignored. CR3 filtering is independent of the value of CR0.PG.

When CR3 filtering is in use, PIP packets may still be seen in the log if the processor is configured to trace when CPL = 0 (IA32_RTIT_CTL.OS = 1). If not, no PIP packets will be seen.

33.2.5.3 Filtering by IP

Trace packet generation with configurable filtering by IP is supported if CPUID.(EAX=14H, ECX=0):EBX[bit 2] = 1. Intel PT can be configured to enable the generation of packets containing architectural states only when the processor is executing code within certain IP ranges. If the IP is outside of these ranges, generation of some packets is blocked.

IP filtering is enabled using the ADDRn_CFG fields in the IA32_RTIT_CTL MSR (Section 33.2.8.2), where the digit 'n' is a zero-based number that selects which address range is being configured. Each ADDRn_CFG field configures the use of the register pair IA32_RTIT_ADDRn_A and IA32_RTIT_ADDRn_B (Section 33.2.8.5). IA32_RTIT_ADDRn_A defines the base and IA32_RTIT_ADDRn_B specifies the limit of the range in which tracing is enabled. Thus each range, referred to as the ADDRn range, is defined by [IA32_RTIT_ADDRn_A, IA32_RTIT_ADDRn_B]. There can be multiple such ranges, software can query CPUID (Section 33.3.1) for the number of ranges supported on a processor.

Default behavior (ADDRn_CFG=0) defines no IP filter range, meaning FilterEn is always set. In this case code at any IP can be traced, though other filters, such as CR3 or CPL, could limit tracing. When ADDRn_CFG is set to enable IP filtering (see Section 33.3.1), tracing will commence when a taken branch or event is seen whose target address is in the ADDRn range.

While inside a tracing region and with FilterEn is set, leaving the tracing region may only be detected once a taken branch or event with a target outside the range is retired. If an ADDRn range is entered or exited by executing the next sequential instruction, rather than by a control flow transfer, FilterEn may not toggle immediately. See Section 33.2.6.5 for more details on FilterEn.

Note that these address range base and limit values are inclusive, such that the range includes the first and last instruction whose first instruction byte is in the ADDRn range.

Depending upon processor implementation, IP filtering may be based on linear or effective address. This can cause different behavior between implementations if CSbase is not equal to zero or in real mode. See Section 33.3.1.1 for details. Software can query CPUID to determine filters are based on linear or effective address (Section 33.3.1).

Note that some packets, such as MTC (Section 33.3.7) and other timing packets, do not depend on FilterEn. For details on which packets depend on FilterEn, and hence are impacted by IP filtering, see Section 33.4.1.

TraceStop

The ADDRn ranges can also be configured to cause tracing to be disabled upon entry to the specified region. This is intended for cases where unexpected code is executed, and the user wishes to immediately stop generating packets in order to avoid overwriting previously written packets.

The TraceStop mechanism works much the same way that IP filtering does, and uses the same address comparison logic. The TraceStop region base and limit values are programmed into one or more ADDRn ranges, but IA32_RTIT_CTL.ADDRn_CFG is configured with the TraceStop encoding. Like FilterEn, TraceStop is detected when a taken branch or event lands in a TraceStop region.

Further, TraceStop requires that TriggerEn=1 at the beginning of the branch/event, and ContextEn=1 upon completion of the branch/event. When this happens, the CPU will set IA32_RTIT_STATUS.Stopped, thereby clearing TriggerEn and hence disabling packet generation. This may generate a TIP.PGD packet with the target IP of the branch or event that entered the TraceStop region. Finally, a TraceStop packet will be inserted, to indicate that the condition was hit.

If a TraceStop condition is encountered during buffer overflow (Section 33.3.8), it will not be dropped, but will instead be signaled once the overflow has resolved.

Note that a TraceStop event does not guarantee that all internally buffered packets are flushed out of internal buffers. To ensure that this has occurred, the user should clear TraceEn.

To resume tracing after a TraceStop event, the user must first disable Intel PT by clearing IA32_RTIT_CTL.TraceEn before the IA32_RTIT_STATUS.Stopped bit can be cleared. At this point Intel PT can be reconfigured, and tracing resumed.

Note that the IA32_RTIT_STATUS.Stopped bit can also be set using the ToPA STOP bit. See Section 33.2.7.2.

IP Filtering Example

The following table gives an example of IP filtering behavior. Assume that IA32_RTIT_ADDRn_A = the IP of RangeBase, and that IA32_RTIT_ADDRn_B = the IP of RangeLimit, while IA32_RTIT_CTL.ADDRn_CFG = 0x1 (enable ADDRn range as a FilterEn range).

Table 33-2. IP Filtering Packet Example

Code Flow	Packets
<pre> Bar: jmp RangeBase // jump into filter range RangeBase: jcc Foo // not taken add eax, 1 Foo: jmp RangeLimit+1 // jump out of filter range RangeLimit: nop jcc Bar </pre>	<pre> TIP.PGE(RangeBase) TNT(0) TIP.PGD(RangeLimit+1) </pre>

IP Filtering and TraceStop

It is possible for the user to configure IP filter range(s) and TraceStop range(s) that overlap. In this case, code executing in the non-overlapping portion of either range will behave as would be expected from that range. Code executing in the overlapping range will get TraceStop behavior.

33.2.6 Packet Generation Enable Controls

Intel Processor Trace includes a variety of controls that determine whether a packet is generated. In general, most packets are sent only if Packet Enable (**PacketEn**) is set. PacketEn is an internal state maintained in hardware in response to software configurable enable controls, PacketEn is not visible to software directly. The relationship of PacketEn to the software-visible controls in the configuration MSRs is described in this section.

33.2.6.1 Packet Enable (PacketEn)

When PacketEn is set, the processor is in the mode that Intel PT is monitoring. PacketEn is composed of other states according to this relationship:

$$\text{PacketEn} := \text{TriggerEn} \text{ AND } \text{ContextEn} \text{ AND } \text{FilterEn} \text{ AND } \text{BranchEn}$$

These constituent controls are detailed in the following subsections.

PacketEn ultimately determines when the processor is tracing. When PacketEn is set, all control flow packets are enabled. When PacketEn is clear, no control flow packets are generated, though other packets (timing and book-keeping packets) may still be sent. See Section 33.2.7 for details of PacketEn and packet generation.

Note that, on processors that do not support IP filtering (i.e., CPUID.(EAX=14H, ECX=0):EBX[bit 2] = 0), FilterEn is treated as always set.

33.2.6.2 Trigger Enable (TriggerEn)

Trigger Enable (**TriggerEn**) is the primary indicator that trace packet generation is active. TriggerEn is set when IA32_RTIT_CTL.TraceEn is set, and cleared by any of the following conditions:

- TraceEn is cleared by software.
- A TraceStop condition is encountered and IA32_RTIT_STATUS.Stopped is set.
- IA32_RTIT_STATUS.Error is set due to an operational error (see Section 33.3.10).

Software can discover the current TriggerEn value by reading the IA32_RTIT_STATUS.TriggerEn bit. When TriggerEn is clear, tracing is inactive and no packets are generated.

33.2.6.3 Context Enable (ContextEn)

Context Enable (**ContextEn**) indicates whether the processor is in the state or mode that software configured hardware to trace. For example, if execution with CPL = 0 code is not being traced (IA32_RTIT_CTL.OS = 0), then ContextEn will be 0 when the processor is in CPL0.

Software can discover the current ContextEn value by reading the IA32_RTIT_STATUS.ContextEn bit. ContextEn is defined as follows:

```
ContextEn = !((IA32_RTIT_CTL.OS = 0 AND CPL = 0) OR
(IA32_RTIT_CTL.USER = 0 AND CPL > 0) OR (IS_IN_A_PRODUCTION_ENCLAVE1) OR
(IA32_RTIT_CTL.CR3Filter = 1 AND IA32_RTIT_CR3_MATCH does not match CR3))
```

If the clearing of ContextEn causes PacketEn to be cleared, a Packet Generation Disable (TIP.PGD) packet is generated, but its IP payload is suppressed. If the setting of ContextEn causes PacketEn to be set, a Packet Generation Enable (TIP.PGE) packet is generated.

When ContextEn is 0, control flow packets (TNT, FUP, TIP.*, MODE.*) are not generated, and no Linear Instruction Pointers (LIPs) are exposed. However, some packets, such as MTC and PSB (see Section 33.4.2.16 and Section 33.4.2.17), may still be generated while ContextEn is 0. For details of which packets are generated only when ContextEn is set, see Section 33.4.1.

The processor does not update ContextEn when TriggerEn = 0.

The value of ContextEn will toggle only when TriggerEn = 1.

33.2.6.4 Branch Enable (BranchEn)

This value is based purely on the IA32_RTIT_CTL.BranchEn value. If **BranchEn** is not set, then relevant COFI packets (TNT, TIP*, FUP, MODE.*) are suppressed. Other packets related to timing (TSC, TMA, MTC, CYC), as well as PSB, will be generated normally regardless. Further, PIP and VMCS continue to be generated, as indicators of what software is running.

33.2.6.5 Filter Enable (FilterEn)

Filter Enable indicates that the Instruction Pointer (IP) is within the range of IPs that Intel PT is configured to watch. Software can get the state of Filter Enable by a RDMSR of IA32_RTIT_STATUS.FilterEn. For details on configuration and use of IP filtering, see Section 33.2.5.3.

On clearing of FilterEn that also clears PacketEn, a Packet Generation Disable (TIP.PGD) will be generated, but unlike the ContextEn case, the IP payload may not be suppressed. For direct, unconditional branches, as well as for indirect branches (including RETs), the PGD generated by leaving the tracing region and clearing FilterEn will contain the target IP. This means that IPs from outside the configured range can be exposed in the trace, as long as they are within context.

When FilterEn is 0, control flow packets are not generated (e.g., TNT, TIP). However, some packets, such as PIP, MTC, and PSB, may still be generated while FilterEn is clear. For details on packet enable dependencies, see Section 33.4.1.

1. Trace packets generation is disabled in a production enclave, see Section 33.2.9.5. See the Intel® 64 and IA-32 Architectures Software Developer's Manual, Volume 3D, about differences between a production enclave and a debug enclave.

After TraceEn is set, FilterEn is set to 1 at all times if there is no IP filter range configured by software (IA32_RTIT_CTL.ADDRn_CFG != 1, for all n), or if the processor does not support IP filtering (i.e., CPUID.(EAX=14H, ECX=0):EBX[bit 2] = 0). FilterEn will toggle only when TraceEn=1 and ContextEn=1, and when at least one range is configured for IP filtering.

33.2.7 Trace Output

Intel PT output should be viewed independently from trace content and filtering mechanisms. The options available for trace output can vary across processor generations and platforms.

Trace output is written out using one of the following output schemes, as configured by the ToPA and FabricEn bit fields of IA32_RTIT_CTL (see Section 33.2.8.2):

- A single, contiguous region of physical address space.
- A collection of variable-sized regions of physical memory. These regions are linked together by tables of pointers to those regions, referred to as Table of Physical Addresses (**ToPA**). The trace output stores bypass the caches and the TLBs, but are not serializing. This is intended to minimize the performance impact of the output.
- A platform-specific trace transport subsystem.

Regardless of the output scheme chosen, Intel PT stores bypass the processor caches by default. This ensures that they don't consume precious cache space, but they do not have the serializing aspects associated with un-cacheable (UC) stores. Software should avoid using MTRRs to mark any portion of the Intel PT output region as UC, as this may override the behavior described above and force Intel PT stores to UC, thereby incurring severe performance impact.

There is no guarantee that a packet will be written to memory or other trace endpoint after some fixed number of cycles after a packet-producing instruction executes. The only way to assure that all packets generated have reached their endpoint is to clear TraceEn and follow that with a store, fence, or serializing instruction; doing so ensures that all buffered packets are flushed out of the processor.

33.2.7.1 Single Range Output

When IA32_RTIT_CTL.ToPA and IA32_RTIT_CTL.FabricEn bits are clear, trace packet output is sent to a single, contiguous memory (or MMIO if DRAM is not available) range defined by a base address in IA32_RTIT_OUTPUT_BASE (Section 33.2.8.7) and mask value in IA32_RTIT_OUTPUT_MASK_PTRS (Section 33.2.8.8). The current write pointer in this range is also stored in IA32_RTIT_OUTPUT_MASK_PTRS. This output range is circular, meaning that when the writes wrap around the end of the buffer they begin again at the base address.

This output method is best suited for cases where Intel PT output is either:

- Configured to be directed to a sufficiently large contiguous region of DRAM.
- Configured to go to an MMIO debug port, in order to route Intel PT output to a platform-specific trace endpoint (e.g., JTAG). In this scenario, a specific range of addresses is written in a circular manner, and SoC will intercept these writes and direct them to the proper device. Repeated writes to the same address do not overwrite each other, but are accumulated by the debugger, and hence no data is lost by the circular nature of the buffer.

The processor will determine the address to which to write the next trace packet output byte as follows:

```
OutputBase[63:0] := IA32_RTIT_OUTPUT_BASE[63:0]
OutputMask[63:0] := ZeroExtend64(IA32_RTIT_OUTPUT_MASK_PTRS[31:0])
OutputOffset[63:0] := ZeroExtend64(IA32_RTIT_OUTPUT_MASK_PTRS[63:32])
trace_store_phys_addr := (OutputBase & ~OutputMask) + (OutputOffset & OutputMask)
```

Single-Range Output Errors

If the output base and mask are not properly configured by software, an operational error (see Section 33.3.10) will be signaled, and tracing disabled. Error scenarios with single-range output are:

- Mask value is non-contiguous.
IA32_RTIT_OUTPUT_MASK_PTRS.MaskOrTablePointer value has a 0 in a less significant bit position than the most significant bit containing a 1.
- Base address and Mask are mis-aligned, and have overlapping bits set.
IA32_RTIT_OUTPUT_BASE && IA32_RTIT_OUTPUT_MASK_PTRS[31:0] > 0.
- Illegal Output Offset
IA32_RTIT_OUTPUT_MASK_PTRS.OutputOffset is greater than the mask value IA32_RTIT_OUTPUT_MASK_PTRS[31:0].

Also note that errors can be signaled due to trace packet output overlapping with restricted memory, see Section 33.2.7.4.

33.2.7.2 Table of Physical Addresses (ToPA)

When IA32_RTIT_CTL.ToPA is set and IA32_RTIT_CTL.FabricEn is clear, the ToPA output mechanism is utilized. The ToPA mechanism uses a linked list of tables; see Figure 33-1 for an illustrative example. Each entry in the table contains some attribute bits, a pointer to an output region, and the size of the region. The last entry in the table may hold a pointer to the next table. This pointer can either point to the top of the current table (for circular array) or to the base of another table. The table size is not fixed, since the link to the next table can exist at any entry.

The processor treats the various output regions referenced by the ToPA table(s) as a unified buffer. This means that a single packet may span the boundary between one output region and the next.

The ToPA mechanism is controlled by three values maintained by the processor:

- **proc_trace_table_base.**
This is the physical address of the base of the current ToPA table. When tracing is enabled, the processor loads this value from the IA32_RTIT_OUTPUT_BASE MSR. While tracing is enabled, the processor updates the IA32_RTIT_OUTPUT_BASE MSR with changes to proc_trace_table_base, but these updates may not be synchronous to software execution. When tracing is disabled, the processor ensures that the MSR contains the latest value of proc_trace_table_base.
- **proc_trace_table_offset.**
This indicates the entry of the current table that is currently in use. (This entry contains the address of the current output region.) When tracing is enabled, the processor loads the value from bits 31:7 (MaskOrTableOffset) of the IA32_RTIT_OUTPUT_MASK_PTRS into bits 27:3 of proc_trace_table_offset. While tracing is enabled, the processor updates IA32_RTIT_OUTPUT_MASK_PTRS.MaskOrTableOffset with changes to proc_trace_table_offset, but these updates may not be synchronous to software execution. When tracing is disabled, the processor ensures that the MSR contains the latest value of proc_trace_table_offset.
- **proc_trace_output_offset.**
This a pointer into the current output region and indicates the location of the next write. When tracing is enabled, the processor loads this value from bits 63:32 (OutputOffset) of the IA32_RTIT_OUTPUT_MASK_PTRS. While tracing is enabled, the processor updates IA32_RTIT_OUTPUT_MASK_PTRS.OutputOffset with changes to proc_trace_output_offset, but these updates may not be synchronous to software execution. When tracing is disabled, the processor ensures that the MSR contains the latest value of proc_trace_output_offset.

Figure 33-1 provides an illustration (not to scale) of the table and associated pointers.

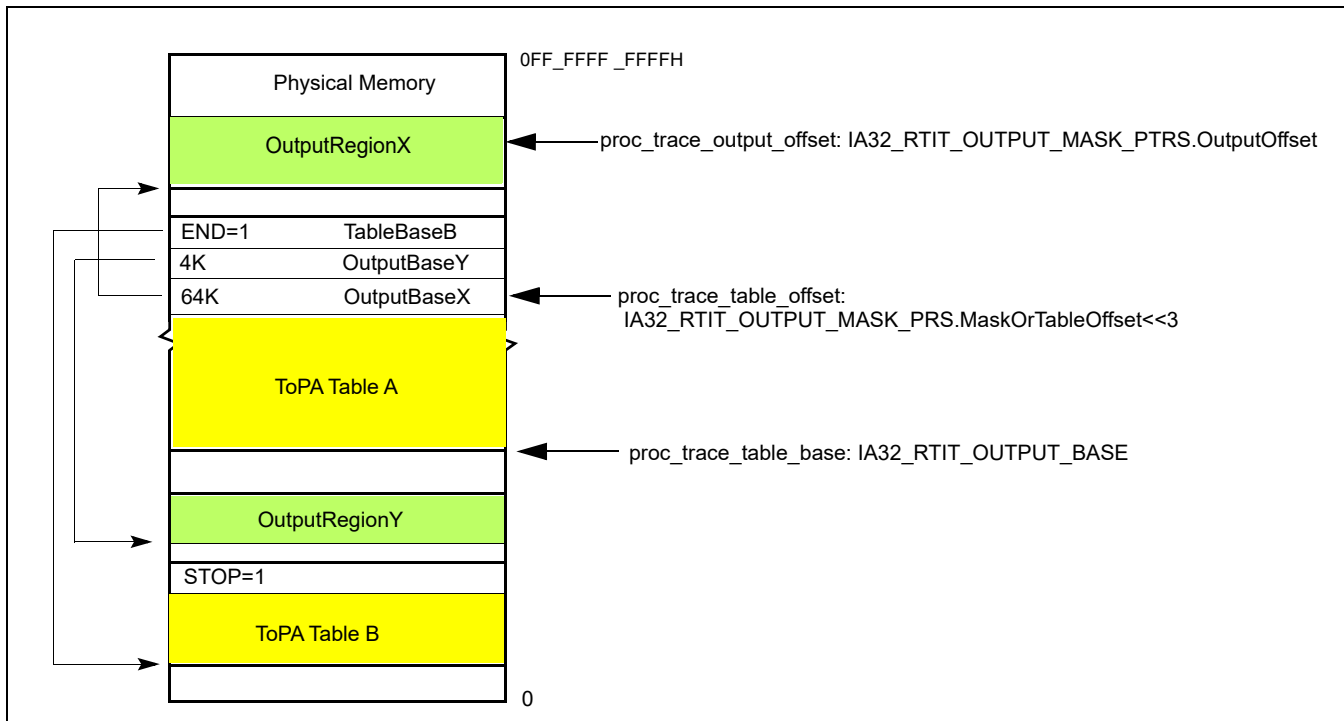

Figure 33-1. ToPA Memory Illustration

With the ToPA mechanism, the processor writes packets to the current output region (identified by `proc_trace_table_base` and the `proc_trace_table_offset`). The offset within that region to which the next byte will be written is identified by `proc_trace_output_offset`. When that region is filled with packet output (thus `proc_trace_output_offset = RegionSize-1`), `proc_trace_table_offset` is moved to the next ToPA entry, `proc_trace_output_offset` is set to 0, and packet writes begin filling the new output region specified by `proc_trace_table_offset`.

As packets are written out, each store derives its physical address as follows:

```
trace_store_phys_addr := Base address from current ToPA table entry +
proc_trace_output_offset
```

Eventually, the regions represented by all entries in the table may become full, and the final entry of the table is reached. An entry can be identified as the final entry because it has either the END or STOP attribute. The END attribute indicates that the address in the entry does not point to another output region, but rather to another ToPA table. The STOP attribute indicates that tracing will be disabled once the corresponding region is filled. See Table 33-3 and the section that follows for details on STOP.

When an END entry is reached, the processor loads `proc_trace_table_base` with the base address held in this END entry, thereby moving the current table pointer to this new table. The `proc_trace_table_offset` is reset to 0, as is the `proc_trace_output_offset`, and packet writes will resume at the base address indicated in the first entry.

If the table has no STOP or END entry, and trace-packet generation remains enabled, eventually the maximum table size will be reached (`proc_trace_table_offset = 0FFFFFF8H`). In this case, the `proc_trace_table_offset` and `proc_trace_output_offset` are reset to 0 (wrapping back to the beginning of the current table) once the last output region is filled.

It is important to note that processor updates to the IA32_RTIT_OUTPUT_BASE and IA32_RTIT_OUTPUT_MASK_PTRS MSRs are asynchronous to instruction execution. Thus, reads of these MSRs while Intel PT is enabled may return stale values. Like all IA32_RTIT_* MSRs, the values of these MSRs should not be trusted or saved unless trace packet generation is first disabled by clearing IA32_RTIT_CTL.TraceEn. This ensures that the output MSR values account for all packets generated to that point, after which the processor will cease updating the output MSR values until tracing resumes.¹

The processor may cache internally any number of entries from the current table or from tables that it references (directly or indirectly). If tracing is enabled, the processor may ignore or delay detection of modifications to these tables. To ensure that table changes are detected by the processor in a predictable manner, software should clear TraceEn before modifying the current table (or tables that it references) and only then re-enable packet generation.

Single Output Region ToPA Implementation

The first processor generation to implement Intel PT supports only ToPA configurations with a single ToPA entry followed by an END entry that points back to the first entry (creating one circular output buffer). Such processors enumerate CPUID.(EAX=14H,ECX=0):ECX.MENTRY[bit 1] = 0 and CPUID.(EAX=14H,ECX=0):ECX.TOPAOUT[bit 0] = 1.

If CPUID.(EAX=14H,ECX=0):ECX.MENTRY[bit 1] = 0, ToPA tables can hold only one output entry, which must be followed by an END=1 entry which points back to the base of the table. Hence only one contiguous block can be used as output.

The lone output entry can have INT or STOP set, but nonetheless must be followed by an END entry as described above. Note that, if INT=1, the PMI will actually be delivered before the region is filled.

ToPA Table Entry Format

The format of ToPA table entries is shown in Figure 33-2. The size of the address field is determined by the processor’s physical-address width (MAXPHYADDR) in bits, as reported in CPUID.80000008H:EAX[7:0].

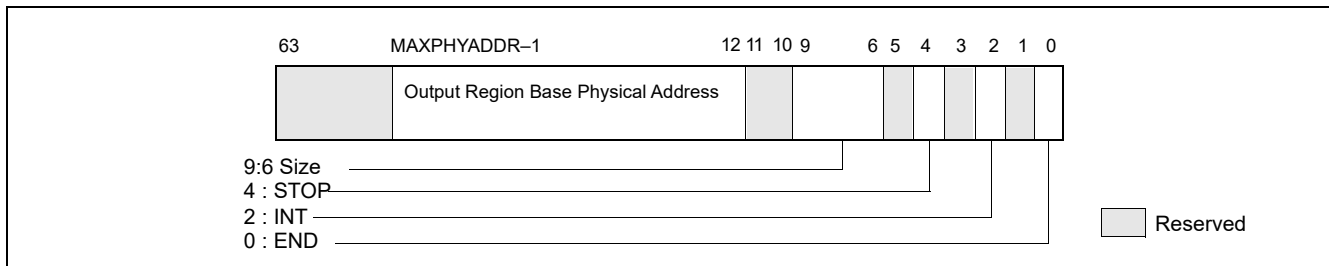

Figure 33-2. Layout of ToPA Table Entry

Table 33-3 describes the details of the ToPA table entry fields. If reserved bits are set to 1, an error is signaled.

Table 33-3. ToPA Table Entry Fields

ToPA Entry Field	Description
Output Region Base Physical Address	If END=0, this is the base physical address of the output region specified by this entry. Note that all regions must be aligned based on their size. Thus a 2M region must have bits 20:12 clear. If the region is not properly aligned, an operational error will be signaled when the entry is reached. If END=1, this is the 4K-aligned base physical address of the next ToPA table (which may be the base of the current table, or the first table in the linked list if a circular buffer is desired). If the processor supports only a single ToPA output region (see above), this address must be the value currently in the IA32_RTIT_OUTPUT_BASE MSR.

1. Although WRMSR is a serializing instruction, the execution of WRMSR that forces packet writes by clearing TraceEn does not itself cause these writes to be globally observed.

Table 33-3. ToPA Table Entry Fields (Contd.)

ToPA Entry Field	Description
Size	Indicates the size of the associated output region. Encodings are: 0: 4K, 1: 8K, 2: 16K, 3: 32K, 4: 64K, 5: 128K, 6: 256K, 7: 512K, 8: 1M, 9: 2M, 10: 4M, 11: 8M, 12: 16M, 13: 32M, 14: 64M, 15: 128M This field is ignored if END=1.
STOP	When the output region indicated by this entry is filled, software should disable packet generation. This will be accomplished by setting IA32_RTIT_STATUS.Stopped, which clears TriggerEn. This bit must be 0 if END=1; otherwise it is treated as reserved bit violation (see ToPA Errors).
INT	When the output region indicated by this entry is filled, signal Perfmon LVT interrupt. Note that if both INT and STOP are set in the same entry, the STOP will happen before the INT. Thus the interrupt handler should expect that the IA32_RTIT_STATUS.Stopped bit will be set, and will need to be reset before tracing can be resumed. This bit must be 0 if END=1; otherwise it is treated as reserved bit violation (see ToPA Errors).
END	If set, indicates that this is an END entry, and thus the address field points to a table base rather than an output region base. If END=1, INT and STOP must be set to 0; otherwise it is treated as reserved bit violation (see ToPA Errors). The Size field is ignored in this case. If the processor supports only a single ToPA output region (see above), END must be set in the second table entry.

ToPA STOP

Each ToPA entry has a STOP bit. If this bit is set, the processor will set the IA32_RTIT_STATUS.Stopped bit when the corresponding trace output region is filled. This will clear TriggerEn and thereby cease packet generation. See Section 33.2.8.4 for details on IA32_RTIT_STATUS.Stopped. This sequence is known as “ToPA Stop”.

No TIP.PGD packet will be seen in the output when the ToPA stop occurs, since the disable happens only when the region is already full. When this occurs, output ceases after the last byte of the region is filled, which may mean that a packet is cut off in the middle. Any packets remaining in internal buffers are lost and cannot be recovered.

When ToPA stop occurs, the IA32_RTIT_OUTPUT_BASE MSR will hold the base address of the table whose entry had STOP=1. IA32_RTIT_OUTPUT_MASK_PTRS.MaskOffsetTableOffset will hold the index value for that entry, and the IA32_RTIT_OUTPUT_MASK_PTRS.OutputOffset should be set to the size of the region minus one.

Note that this means the offset pointer is pointing to the next byte after the end of the region, a configuration that would produce an operational error if the configuration remained when tracing is re-enabled with IA32_RTIT_STATUS.Stopped cleared.

ToPA PMI

Each ToPA entry has an INT bit. If this bit is set, the processor will signal a performance-monitoring interrupt (PMI) when the corresponding trace output region is filled. This interrupt is not precise, and it is thus likely that writes to the next region will occur by the time the interrupt is taken.

The following steps should be taken to configure this interrupt:

1. Enable PMI via the LVT Performance Monitor register (at MMIO offset 340H in xAPIC mode; via MSR 834H in x2APIC mode). See the Intel® 64 and IA-32 Architectures Software Developer’s Manual, Volume 3B, for more details on this register. For ToPA PMI, set all fields to 0, save for the interrupt vector, which can be selected by software.
2. Set up an interrupt handler to service the interrupt vector that a ToPA PMI can raise.
3. Set the interrupt flag by executing STI.
4. Set the INT bit in the ToPA entry of interest and enable packet generation, using the ToPA output option. Thus, TraceEn=ToPA=1 in the IA32_RTIT_CTL MSR.

Once the INT region has been filled with packet output data, the interrupt will be signaled. This PMI can be distinguished from others by checking bit 55 (Trace_ToPA_PMI) of the IA32_PERF_GLOBAL_STATUS MSR (MSR 38EH). Once the ToPA PMI handler has serviced the relevant buffer, writing 1 to bit 55 of the MSR at 390H (IA32_GLOBAL_STATUS_RESET) clears IA32_PERF_GLOBAL_STATUS.Trace_ToPA_PMI.

Intel PT is not frozen on PMI, and thus the interrupt handler will be traced (though filtering can prevent this). The Freeze_Perfmon_on_PMI and Freeze_LBRs_on_PMI settings in IA32_DEBUGCTL will be applied on ToPA PMI just as on other PMIs, and hence Perfmon counters are frozen.

Assuming the PMI handler wishes to read any buffered packets for persistent output, or wishes to modify any Intel PT MSRs, software should first disable packet generation by clearing TraceEn. This ensures that all buffered packets are written to memory and avoids tracing of the PMI handler. The configuration MSRs can then be used to determine where tracing has stopped. If packet generation is disabled by the handler, it should then be manually re-enabled before the IRET if continued tracing is desired.

In rare cases, it may be possible to trigger a second ToPA PMI before the first is handled. This can happen if another ToPA region with INT=1 is filled before, or shortly after, the first PMI is taken, perhaps due to EFLAGS.IF being cleared for an extended period of time. This can manifest in two ways: either the second PMI is triggered before the first is taken, and hence only one PMI is taken, or the second is triggered after the first is taken, and thus will be taken when the handler for the first completes. Software can minimize the likelihood of the second case by clearing TraceEn at the beginning of the PMI handler. Further, it can detect such cases by then checking the Interrupt Request Register (IRR) for PMI pending, and checking the ToPA table base and off-set pointers (in IA32_RTIT_OUTPUT_BASE and IA32_RTIT_OUTPUT_MASK_PTRS) to see if multiple entries with INT=1 have been filled.

PMI Preservation

In some cases a ToPA PMI may be taken after completion of an XSAVES instruction that saves Intel PT state, and in such cases any modification of Intel PT MSRs within the PMI handler will not persist when the saved Intel PT context is later restored with XRSTORS. To account for such a scenario, the PMI Preservation feature has been added. Support for this feature is indicated by CPUID.(EAX=14H, ECX=0):EBX[bit 6].

When IA32_RTIT_CTL.InjectPsbPmiOnEnable[56] = 1, PMI preservation is enabled. When a ToPA region with INT=1 is filled, a PMI is pended and the new IA32_RTIT_STATUS.PendToPAPMI[7] is set to 1. If this bit is set when Intel PT is enabled, such that IA32_RTIT_CTL.TraceEn[0] transitions from 0 to 1, a ToPA PMI is pended. This behavior ensures that any ToPA PMI that is pended during XSAVES, and hence can't be properly handled, will be re-pended when the saved PT state is restored.

When this feature is enabled, the PMI handler should take the following actions:

1. Ignore ToPA PMIs that are taken when TraceEn = 0. This indicates that the PMI was pended during Intel PT disable, and the PendToPAPMI flag will ensure that the PMI is re-pended once Intel PT is re-enabled in the same context. For this reason, the PendToPAPMI bit should be left set to 1.
2. If TraceEn=1 and the PMI can be properly handled, clear the new PendTopaPMI bit. This will ensure that additional, spurious ToPA PMIs are not taken. It is required that PendToPAPMI is cleared before the PMI LVT mask is cleared in the APIC, and before any clearing of either LBRs_FROZEN or COUNTERS_FROZEN in IA32_PERF_GLOBAL_STATUS.

ToPA PMI and Single Output Region ToPA Implementation

A processor that supports only a single ToPA output region implementation (such that only one output region is supported; see above) will attempt to signal a ToPA PMI interrupt before the output wraps and overwrites the top of the buffer. To support this functionality, the PMI handler should disable packet generation as soon as possible.

Due to PMI skid, it is possible that, in rare cases, the wrap will have occurred before the PMI is delivered. Software can avoid this by setting the STOP bit in the ToPA entry (see Table 33-3); this will disable tracing once the region is filled, and no wrap will occur. This approach has the downside of disabling packet generation so that some of the instructions that led up to the PMI will not be traced. If the PMI skid is significant enough to cause the region to fill and tracing to be disabled, the PMI handler will need to clear the IA32_RTIT_STATUS.Stopped indication before tracing can resume.

ToPA PMI and XSAVES/XRSTORS State Handling

In some cases the ToPA PMI may be taken after completion of an XSAVES instruction that switches Intel PT state, and in such cases any modification of Intel PT MSR within the PMI handler will not persist when the saved Intel PT context is later restored with XRSTORS. To account for such a scenario, it is recommended that the Intel PT output configuration be modified by altering the ToPA tables themselves, rather than the Intel PT output MSRs. On processors that support PMI preservation (CPUID.(EAX=14H, ECX=0):EBX[bit 6] = 1), setting IA32_RTIT_CTL.InjectPsbPmiOnEnable[56] = 1 will ensure that a PMI that is pending at the time PT is disabled will be recorded by setting IA32_RTIT_STATUS.PendTopaPMI[7] = 1. A PMI will then be pending when the saved PT context is later restored.

Table 33-4 depicts a recommended PMI handler algorithm for managing multi-region ToPA output and handling ToPA PMIs that may arrive between XSAVES and XRSTORS, if PMI preservation is not in use. This algorithm is flexible to allow software to choose between adding entries to the current ToPA table, adding a new ToPA table, or using the current ToPA table as a circular buffer. It assumes that the ToPA entry that triggers the PMI is not the last entry in the table, which is the recommended treatment.

Table 33-4. Algorithm to Manage Intel PT ToPA PMI and XSAVES/XRSTORS

Pseudo Code Flow
<pre> IF (IA32_PERF_GLOBAL_STATUS.ToPA) Save IA32_RTIT_CTL value; IF (IA32_RTIT_CTL.TraceEN) Disable Intel PT by clearing TraceEn; FI; IF (there is space available to grow the current ToPA table) Add one or more ToPA entries after the last entry in the ToPA table; Point new ToPA entry address field(s) to new output region base(s); ELSE Modify an upcoming ToPA entry in the current table to have END=1; IF (output should transition to a new ToPA table) Point the address of the "END=1" entry of the current table to the new table base; ELSE /* Continue to use the current ToPA table, make a circular. */ Point the address of the "END=1" entry to the base of the current table; Modify the ToPA entry address fields for filled output regions to point to new, unused output regions; /* Filled regions are those with index in the range of 0 to (IA32_RTIT_MASK_PTRS.MaskOrTableOffset -1). */ FI; FI; Restore saved IA32_RTIT_CTL.value; FI; </pre>

ToPA Errors

When a malformed ToPA entry is found, an **operational error** results (see Section 33.3.10). A malformed entry can be any of the following:

1. **ToPA entry reserved bit violation.**
This describes cases where a bit marked as reserved in Section 33.2.7.2 above is set to 1.
2. **ToPA alignment violation.**
This includes cases where illegal ToPA entry base address bits are set to 1:
 - a. ToPA table base address is not 4KB-aligned. The table base can be from a WRMSR to IA32_RTIT_OUTPUT_BASE, or from a ToPA entry with END=1.
 - b. ToPA entry base address is not aligned to the ToPA entry size (e.g., a 2MB region with base address[20:12] not equal to 0), for ToPA entries with END=0.
 - c. ToPA entry base address sets upper physical address bits not supported by the processor.

3. Illegal ToPA Output Offset.

IA32_RTIT_OUTPUT_MASK_PTRS.OutputOffset is greater than or equal to the size of the current ToPA output region size.

4. ToPA rules violations.

These are similar to ToPA entry reserved bit violations; they are cases when a ToPA entry is encountered with illegal field combinations. They include the following:

- a. Setting the STOP or INT bit on an entry with END=1.
- b. Setting the END bit in entry 0 of a ToPA table.
- c. On processors that support only a single ToPA entry (see above), two additional illegal settings apply:
 - i) ToPA table entry 1 with END=0.
 - ii) ToPA table entry 1 with base address not matching the table base.

In all cases, the error will be logged by setting IA32_RTIT_STATUS.Error, thereby disabling tracing when the problematic ToPA entry is reached (when proc_trace_table_offset points to the entry containing the error). Any packet bytes that are internally buffered when the error is detected may be lost.

Note that operational errors may also be signaled due to attempts to access restricted memory. See Section 33.2.7.4 for details.

A tracing software have a range of flexibility using ToPA to manage the interaction of Intel PT with application buffers, see Section 33.4.2.26.

33.2.7.3 Trace Transport Subsystem

When IA32_RTIT_CTL.FabricEn is set, the IA32_RTIT_CTL.ToPA bit is ignored, and trace output is written to the trace transport subsystem. The endpoints of this transport are platform-specific, and details of configuration options should refer to the specific platform documentation. The FabricEn bit is available to be set if CPUID(EAX=14H,ECX=0):EBX[bit 3] = 1.

33.2.7.4 Restricted Memory Access

Packet output cannot be directed to any regions of memory that are restricted by the platform. In particular, all memory accesses on behalf of packet output are checked against the SMRR regions. If there is any overlap with these regions, trace data collection will not function properly. Exact processor behavior is implementation-dependent; Table 33-5 summarizes several scenarios.

Table 33-5. Behavior on Restricted Memory Access

Scenario	Description
ToPA output region overlaps with SMRR	Stores to the restricted memory region will be dropped, and that packet data will be lost. Any attempt to read from that restricted region will return all 1s. The processor also may signal an error (Section 33.3.10) and disable tracing when the output pointer reaches the restricted region. If packet generation remains enabled, then packet output may continue once stores are no longer directed to restricted memory (on wrap, or if the output region is larger than the restricted memory region).
ToPA table overlaps with SMRR	The processor will signal an error (Section 33.3.10) and disable tracing when the ToPA write pointer (IA32_RTIT_OUTPUT_BASE + proc_trace_table_offset) enters the restricted region.

It should also be noted that packet output should not be routed to the 4KB APIC MMIO region, as defined by the IA32_APIC_BASE MSR. For details about the APIC, refer to the Intel® 64 and IA-32 Architectures Software Developer's Manual, Volume 3A. No error is signaled for this case.

Modifications to Restricted Memory Regions

It is recommended that software disable packet generation before modifying the SMRRs to change the scope of the SMRR regions. This is because the processor reserves the right to cache any number of ToPA table entries internally, after checking them against restricted memory ranges. Once cached, the entries will not be checked again, meaning one could potentially route packet output to a newly restricted region. Software can ensure that any cached entries are written to memory by clearing IA32_RTIT_CTL.TraceEn.

33.2.8 Enabling and Configuration MSRs

33.2.8.1 General Considerations

Trace packet generation is enabled and configured by a collection of model-specific registers (MSRs), which are detailed below. Some notes on the configuration MSR behavior:

- If Intel Processor Trace is not supported by the processor (see Section 33.3.1), RDMSR or WRMSR of the IA32_RTIT_* MSRs will cause #GP.
- A WRMSR to any of the IA32_RTIT_* configuration MSRs while packet generation is enabled (IA32_RTIT_CTL.TraceEn=1) will generate a #GP exception. Packet generation must be disabled before the configuration MSRs can be changed.
Note: Software may write the same value back to IA32_RTIT_CTL without #GP, even if TraceEn=1.
- All configuration MSRs for Intel PT are duplicated per logical processor
- For each configuration MSR, any MSR write that attempts to change bits marked reserved, or utilize encodings marked reserved, will cause a #GP fault.
- All configuration MSRs for Intel PT are cleared on a warm or cold RESET.
 - If CPUID.(EAX=14H, ECX=0):EBX[bit 2] = 1, only the TraceEn bit is cleared on warm RESET; though this may have the impact of clearing other bits in IA32_RTIT_STATUS. Other MSR values of the trace configuration MSRs are preserved on warm RESET.
- The semantics of MSR writes to trace configuration MSRs in this chapter generally apply to explicit WRMSR to these registers, using VMexit or VM entry MSR load list to these MSRs, XRSTORS with requested feature bit map including XSAVE map component of state_8 (corresponding to IA32_XSS[bit 8]), and the write to IA32_RTIT_CTL.TraceEn by XSAVES (Section 33.3.5.2).

33.2.8.2 IA32_RTIT_CTL MSR

IA32_RTIT_CTL, at address 570H, is the primary enable and control MSR for trace packet generation. Bit positions are listed in Table 33-6.

Table 33-6. IA32_RTIT_CTL MSR

Position	Bit Name	At Reset	Bit Description
0	TraceEn	0	If 1, enables tracing; else tracing is disabled. When this bit transitions from 1 to 0, all buffered packets are flushed out of internal buffers. A further store, fence, or architecturally serializing instruction may be required to ensure that packet data can be observed at the trace endpoint. See Section 33.2.8.3 for details of enabling and disabling packet generation. Note that the processor will clear this bit on #SMI (Section 33.2.9.3) and warm reset. Other MSR bits of IA32_RTIT_CTL (and other trace configuration MSRs) are not impacted by these events.
1	CYCEn	0	0: Disables CYC Packet (see Section 33.4.2.14). 1: Enables CYC Packet. This bit is reserved if CPUID.(EAX=14H, ECX=0):EBX[bit 1] = 0.
2	OS	0	0: Packet generation is disabled when CPL = 0. 1: Packet generation may be enabled when CPL = 0.
3	User	0	0: Packet generation is disabled when CPL > 0. 1: Packet generation may be enabled when CPL > 0.
4	PwrEvtEn	0	0: Power Event Trace packets are disabled. 1: Power Event Trace packets are enabled (see Section 33.2.3, “Power Event Tracing”).

Table 33-6. IA32_RTIT_CTL MSR (Contd.)

Position	Bit Name	At Reset	Bit Description
5	FUPonPTW	0	0: PTW packets are not followed by FUPs. 1: PTW packets are followed by FUPs. This bit is reserved when CPUID.(EAX=14H, ECX=0):EBX[bit 4] ("PTWRITE Supported") is 0.
6	FabricEn	0	0: Trace output is directed to the memory subsystem, mechanism depends on IA32_RTIT_CTL.ToPA. 1: Trace output is directed to the trace transport subsystem, IA32_RTIT_CTL.ToPA is ignored. This bit is reserved if CPUID.(EAX=14H, ECX=0):ECX[bit 3] = 0.
7	CR3Filter	0	0: Disables CR3 filtering. 1: Enables CR3 filtering. This bit is reserved if CPUID.(EAX=14H, ECX=0):EBX[bit 0] ("CR3 Filtering Support") is 0.
8	ToPA	0	0: Single-range output scheme enabled if CPUID.(EAX=14H, ECX=0):ECX.SNGLRGNOUT[bit 2] = 1 and IA32_RTIT_CTL.FabricEn=0. 1: ToPA output scheme enabled (see Section 33.2.7.2) if CPUID.(EAX=14H, ECX=0):ECX.TOPA[bit 0] = 1, and IA32_RTIT_CTL.FabricEn=0. Note: WRMSR to IA32_RTIT_CTL that sets TraceEn but clears this bit and FabricEn would cause #GP, if CPUID.(EAX=14H, ECX=0):ECX.SNGLRGNOUT[bit 2] = 0. WRMSR to IA32_RTIT_CTL that sets this bit causes #GP, if CPUID.(EAX=14H, ECX=0):ECX.TOPA[bit 0] = 0.
9	MTCEn	0	0: Disables MTC Packet (see Section 33.4.2.16). 1: Enables MTC Packet. This bit is reserved if CPUID.(EAX=14H, ECX=0):EBX[bit 3] = 0.
10	TSCEn	0	0: Disable TSC packets. 1: Enable TSC packets (see Section 33.4.2.11).
11	DisRETC	0	0: Enable RET compression. 1: Disable RET compression (see Section 33.2.1.2).
12	PTWEn	0	0: PTWRITE packet generation disabled. 1: PTWRITE packet generation enabled (see Table 33-40 "PTW Packet Definition"). This bit is reserved when CPUID.(EAX=14H, ECX=0):EBX[bit 4] ("PTWRITE Supported") is 0.
13	BranchEn	0	0: Disable COFI-based packets. 1: Enable COFI-based packets: FUP, TIP, TIP.PGE, TIP.PGD, TNT, MODE.Exec, MODE.TSX. See Section 33.2.6.4 for details on BranchEn.
17:14	MTCFreq	0	Defines MTC packet Frequency, which is based on the core crystal clock, or Always Running Timer (ART). MTC will be sent each time the selected ART bit toggles. The following Encodings are defined: 0: ART(0), 1: ART(1), 2: ART(2), 3: ART(3), 4: ART(4), 5: ART(5), 6: ART(6), 7: ART(7), 8: ART(8), 9: ART(9), 10: ART(10), 11: ART(11), 12: ART(12), 13: ART(13), 14: ART(14), 15: ART(15) Software must use CPUID to query the supported encodings in the processor, see Section 33.3.1. Use of unsupported encodings will result in a #GP fault. This field is reserved if CPUID.(EAX=14H, ECX=0):EBX[bit 3] = 0.
18	Reserved	0	Must be 0.

Table 33-6. IA32_RTIT_CTL MSR (Contd.)

Position	Bit Name	At Reset	Bit Description
22:19	CycThresh	0	CYC packet threshold, see Section 33.3.6 for details. CYC packets will be sent with the first eligible packet after N cycles have passed since the last CYC packet. If CycThresh is 0 then N=0, otherwise N is defined as $2^{(\text{CycThresh}-1)}$. The following Encodings are defined: 0: 0, 1: 1, 2: 2, 3: 4, 4: 8, 5: 16, 6: 32, 7: 64, 8: 128, 9: 256, 10: 512, 11: 1024, 12: 2048, 13: 4096, 14: 8192, 15: 16384 Software must use CPUID to query the supported encodings in the processor, see Section 33.3.1. Use of unsupported encodings will result in a #GP fault. This field is reserved if CPUID.(EAX=14H, ECX=0):EBX[bit 1] = 0.
23	Reserved	0	Must be 0.
27:24	PSBFreq	0	Indicates the frequency of PSB packets. PSB packet frequency is based on the number of Intel PT packet bytes output, so this field allows the user to determine the increment of IA32_IA32_RTIT_STATUS.PacketByteCnt that should cause a PSB to be generated. Note that PSB insertion is not precise, but the average output bytes per PSB should approximate the SW selected period. The following Encodings are defined: 0: 2K, 1: 4K, 2: 8K, 3: 16K, 4: 32K, 5: 64K, 6: 128K, 7: 256K, 8: 512K, 9: 1M, 10: 2M, 11: 4M, 12: 8M, 13: 16M, 14: 32M, 15: 64M Software must use CPUID to query the supported encodings in the processor, see Section 33.3.1. Use of unsupported encodings will result in a #GP fault. This field is reserved if CPUID.(EAX=14H, ECX=0):EBX[bit 1] = 0.
30:28	Reserved	0	Must be 0.
31	EventEn	0	0: Event Trace packets are disabled. 1: Event Trace packets are enabled. This bit is reserved when CPUID.(EAX=14H, ECX=0):EBX[bit 7] (“Event Trace Supported”) is 0.
35:32	ADDR0_CFG	0	Configures the base/limit register pair IA32_RTIT_ADDR0_A/B based on the following encodings: 0: ADDR0 range unused. 1: The [IA32_RTIT_ADDR0_A..IA32_RTIT_ADDR0_B] range defines a FilterEn range. FilterEn will only be set when the IP is within this range, though other FilterEn ranges can additionally be used. See Section 33.2.5.3 for details on IP filtering. 2: The [IA32_RTIT_ADDR0_A..IA32_RTIT_ADDR0_B] range defines a TraceStop range. TraceStop will be asserted if code branches into this range. See 4.2.8 for details on TraceStop. 3..15: Reserved (#GP). This field is reserved if CPUID.(EAX=14H, ECX=1):EBX.RANGE CNT[2:0] < 1.
39:36	ADDR1_CFG	0	Configures the base/limit register pair IA32_RTIT_ADDR1_A/B based on the following encodings: 0: ADDR1 range unused. 1: The [IA32_RTIT_ADDR1_A..IA32_RTIT_ADDR1_B] range defines a FilterEn range. FilterEn will only be set when the IP is within this range, though other FilterEn ranges can additionally be used. See Section 33.2.5.3 for details on IP filtering. 2: The [IA32_RTIT_ADDR1_A..IA32_RTIT_ADDR1_B] range defines a TraceStop range. TraceStop will be asserted if code branches into this range. See Section 33.4.2.10 for details on TraceStop. 3..15: Reserved (#GP). This field is reserved if CPUID.(EAX=14H, ECX=1):EBX.RANGE CNT[2:0] < 2.

Table 33-6. IA32_RTIT_CTL MSR (Contd.)

Position	Bit Name	At Reset	Bit Description
43:40	ADDR2_CFG	0	Configures the base/limit register pair IA32_RTIT_ADDR2_A/B based on the following encodings: 0: ADDR2 range unused. 1: The [IA32_RTIT_ADDR2_A..IA32_RTIT_ADDR2_B] range defines a FilterEn range. FilterEn will only be set when the IP is within this range, though other FilterEn ranges can additionally be used. See Section 33.2.5.3 for details on IP filtering. 2: The [IA32_RTIT_ADDR2_A..IA32_RTIT_ADDR2_B] range defines a TraceStop range. TraceStop will be asserted if code branches into this range. See Section 33.4.2.10 for details on TraceStop. 3..15: Reserved (#GP). This field is reserved if CPUID.(EAX=14H, ECX=1):EBX.RANGECONT[2:0] < 3.
47:44	ADDR3_CFG	0	Configures the base/limit register pair IA32_RTIT_ADDR3_A/B based on the following encodings: 0: ADDR3 range unused. 1: The [IA32_RTIT_ADDR3_A..IA32_RTIT_ADDR3_B] range defines a FilterEn range. FilterEn will only be set when the IP is within this range, though other FilterEn ranges can additionally be used. See Section 33.2.5.3 for details on IP filtering. 2: The [IA32_RTIT_ADDR3_A..IA32_RTIT_ADDR3_B] range defines a TraceStop range. TraceStop will be asserted if code branches into this range. See Section 33.4.2.10 for details on TraceStop. 3..15: Reserved (#GP). This field is reserved if CPUID.(EAX=14H, ECX=1):EBX.RANGECONT[2:0] < 4.
54:48	Reserved	0	Reserved only for future trace content enables, or address filtering configuration enables. Must be 0.
55	DisTNT	0	0: Include TNT packets in control flow trace. 1: Omit TNT packets from control flow trace. This bit is reserved when CPUID.(EAX=14H, ECX=0):EBX[bit 8] (“TNT Disable Supported”) is 0. See Section 33.3.9 for details.
56	InjectPsbPmiOnEnable	0	1: Enables use of IA32_RTIT_STATUS bits PendPSB[6] and PendTopaPMI[7], see Section 33.2.8.4, “IA32_RTIT_STATUS MSR,” for behavior of these bits. 0: IA32_RTIT_STATUS bits 6 and 7 are ignored. This field is reserved if CPUID.(EAX=14H, ECX=0):EBX[bit 6] = 0.
59:57	Reserved	0	Reserved only for future trace content enables, or address filtering configuration enables. Must be 0.
63:60	Reserved	0	Must be 0.

33.2.8.3 Enabling and Disabling Packet Generation with TraceEn

When TraceEn transitions from 0 to 1, Intel Processor Trace is enabled, and a series of packets may be generated. These packets help ensure that the decoder is aware of the state of the processor when the trace begins, and that it can keep track of any timing or state changes that may have occurred while packet generation was disabled. A full PSB+ (see Section 33.4.2.17) will be generated if IA32_RTIT_STATUS.PacketByteCnt=0, and may be generated in other cases as well. Otherwise, timing packets will be generated, including TSC, TMA, and CBR (see Section 33.4.1.1).

In addition to the packets discussed above, if and when PacketEn (Section 33.2.6.1) transitions from 0 to 1 (which may happen immediately, depending on filtering settings), a TIP.PGE packet (Section 33.4.2.3) will be generated.

When TraceEn is set, the processor may read ToPA entries from memory and cache them internally. For this reason, software should disable packet generation before making modifications to the ToPA tables (or changing the config-

uration of restricted memory regions). See Section 33.7 for more details of packets that may be generated with modifications to TraceEn.

Disabling Packet Generation

Clearing TraceEn causes any packet data buffered within the logical processor to be flushed out, after which the output MSRs (IA32_RTIT_OUTPUT_BASE and IA32_RTIT_OUTPUT_MASK_PTRS) will have stable values. When output is directed to memory, a store, fence, or architecturally serializing instruction may be required to ensure that the packet data is globally observed. No special packets are generated by disabling packet generation, though a TIP.PGD may result if PacketEn=1 at the time of disable.

Other Writes to IA32_RTIT_CTL

Any attempt to modify IA32_RTIT_CTL while TraceEn is set will result in a general-protection fault (#GP) unless the same write also clears TraceEn. However, writes to IA32_RTIT_CTL that do not modify any bits will not cause a #GP, even if TraceEn remains set.

33.2.8.4 IA32_RTIT_STATUS MSR

The IA32_RTIT_STATUS MSR is readable and writable by software, though some fields cannot be modified by software. See Table 33-7 for details. The WRMSR instruction ignores these bits in the source operand (attempts to modify these bits are ignored and do not cause WRMSR to fault).

This MSR can only be written when IA32_RTIT_CTL.TraceEn is 0; otherwise WRMSR causes a general-protection fault (#GP). The processor does not modify the value of this MSR while TraceEn is 0 (software can modify it with WRMSR).

Table 33-7. IA32_RTIT_STATUS MSR

Position	Bit Name	At Reset	Bit Description
0	FilterEn	0	This bit is written by the processor, and indicates that tracing is allowed for the current IP, see Section 33.2.6.5. Writes are ignored.
1	ContextEn	0	The processor sets this bit to indicate that tracing is allowed for the current context. See Section 33.2.6.3. Writes are ignored.
2	TriggerEn	0	The processor sets this bit to indicate that tracing is enabled. See Section 33.2.6.2. Writes are ignored.
3	Reserved	0	Must be 0.
4	Error	0	The processor sets this bit to indicate that an operational error has been encountered. When this bit is set, TriggerEn is cleared to 0 and packet generation is disabled. For details, see "ToPA Errors" in Section 33.2.7.2. When TraceEn is cleared, software can write this bit. Once it is set, only software can clear it. It is not recommended that software ever set this bit, except in cases where it is restoring a prior saved state.
5	Stopped	0	The processor sets this bit to indicate that a ToPA Stop condition has been encountered. When this bit is set, TriggerEn is cleared to 0 and packet generation is disabled. For details, see "ToPA STOP" in Section 33.2.7.2. When TraceEn is cleared, software can write this bit. Once it is set, only software can clear it. It is not recommended that software ever set this bit, except in cases where it is restoring a prior saved state.
6	PendPSB	0	If IA32_RTIT_CTL.InjectPsbPmiOnEnable[56] = 1, the processor sets this bit when the threshold for a PSB+ to be inserted has been reached. The processor will clear this bit when the PSB+ has been inserted into the trace. If PendPSB = 1 and InjectPsbPmiOnEnable = 1 when IA32_RTIT_CTL.TraceEn[0] transitions from 0 to 1, a PSB+ will be inserted into the trace. This field is reserved if CPUID.(EAX=14H, ECX=0):EBX[bit 6] = 0.

Table 33-7. IA32_RTIT_STATUS MSR

Position	Bit Name	At Reset	Bit Description
7	PendTopaPMI	0	If IA32_RTIT_CTL.InjectPsbPmiOnEnable[56] = 1, the processor sets this bit when the threshold for a ToPA PMI to be inserted has been reached. Software should clear this bit once the ToPA PMI has been handled, see “ToPA PMI” for details. If PendTopaPMI = 1 and InjectPsbPmiOnEnable = 1 when IA32_RTIT_CTL.TraceEn[0] transitions from 0 to 1, a PMI will be pended. This field is reserved if CPUID.(EAX=14H, ECX=0):EBX[bit 6] = 0.
31:8	Reserved	0	Must be 0.
48:32	PacketByteCnt	0	This field is written by the processor, and holds a count of packet bytes that have been sent out. The processor also uses this field to determine when the next PSB packet should be inserted. Note that the processor may clear or modify this field at any time while IA32_RTIT_CTL.TraceEn=1. It will have a stable value when IA32_RTIT_CTL.TraceEn=0. See Section 33.4.2.17 for details. This field is reserved when CPUID.(EAX=14H,ECX=0):EBX[bit 1] (“Configurable PSB and CycleAccurate Mode Supported”) is 0.
63:49	Reserved	0	Must be 0.

33.2.8.5 IA32_RTIT_ADDRn_A and IA32_RTIT_ADDRn_B MSRs

The role of the IA32_RTIT_ADDRn_A/B register pairs, for each n, is determined by the corresponding ADDRn_CFG fields in IA32_RTIT_CTL (see Section 33.2.8.2). The number of these register pairs is enumerated by CPUID.(EAX=14H, ECX=1):EAX.RANGECNT[2:0].

- Processors that enumerate support for 1 range support:
 - IA32_RTIT_ADDR0_A, IA32_RTIT_ADDR0_B
- Processors that enumerate support for 2 ranges support:
 - IA32_RTIT_ADDR0_A, IA32_RTIT_ADDR0_B
 - IA32_RTIT_ADDR1_A, IA32_RTIT_ADDR1_B
- Processors that enumerate support for 3 ranges support:
 - IA32_RTIT_ADDR0_A, IA32_RTIT_ADDR0_B
 - IA32_RTIT_ADDR1_A, IA32_RTIT_ADDR1_B
 - IA32_RTIT_ADDR2_A, IA32_RTIT_ADDR2_B
- Processors that enumerate support for 4 ranges support:
 - IA32_RTIT_ADDR0_A, IA32_RTIT_ADDR0_B
 - IA32_RTIT_ADDR1_A, IA32_RTIT_ADDR1_B
 - IA32_RTIT_ADDR2_A, IA32_RTIT_ADDR2_B
 - IA32_RTIT_ADDR3_A, IA32_RTIT_ADDR3_B

Each register has a single 64-bit field that holds a linear address value. Writes must ensure that the address is in canonical form, otherwise a general-protection fault (#GP) fault will result.

Each MSR can be written only when IA32_RTIT_CTL.TraceEn is 0; otherwise WRMSR causes a general-protection fault (#GP).

33.2.8.6 IA32_RTIT_CR3_MATCH MSR

The IA32_RTIT_CR3_MATCH register is compared against CR3 when IA32_RTIT_CTL.CR3Filter is 1. Bits 63:5 hold the CR3 address value to match, bits 4:0 are reserved to 0. For more details on CR3 filtering and the treatment of this register, see Section 33.2.5.2.

This MSR is accessible if `CPUID.(EAX=14H, ECX=0):EBX[bit 0]`, “CR3 Filtering Support”, is 1. This MSR can be written only when `IA32_RTIT_CTL.TraceEn` is 0; otherwise `WRMSR` causes a general-protection fault (#GP). `IA32_RTIT_CR3_MATCH[4:0]` are reserved and must be 0; an attempt to set those bits using `WRMSR` causes a #GP.

33.2.8.7 IA32_RTIT_OUTPUT_BASE MSR

This MSR is used to configure the trace output destination, when output is directed to memory (`IA32_RTIT_CTL.FabricEn = 0`). The size of the address field is determined by the maximum physical address width (`MAXPHYADDR`), as reported by `CPUID.80000008H:EAX[7:0]`.

When the ToPA output scheme is used, the processor may update this MSR when packet generation is enabled, and those updates are asynchronous to instruction execution. Therefore, the values in this MSR should be considered unreliable unless packet generation is disabled (`IA32_RTIT_CTL.TraceEn = 0`).

Accesses to this MSR are supported only if Intel PT output to memory is supported, hence when either `CPUID.(EAX=14H, ECX=0):ECX[bit 0]` or `CPUID.(EAX=14H, ECX=0):ECX[bit 2]` are set. Otherwise `WRMSR` or `RDMSR` cause a general-protection fault (#GP). If supported, this MSR can be written only when `IA32_RTIT_CTL.TraceEn` is 0; otherwise `WRMSR` causes a general-protection fault (#GP).

Table 33-8. IA32_RTIT_OUTPUT_BASE MSR

Position	Bit Name	At Reset	Bit Description
6:0	Reserved	0	Must be 0.
MAXPHYADDR-1:7	BasePhysAddr	0	<p>The base physical address. How this address is used depends on the value of <code>IA32_RTIT_CTL.ToPA</code>:</p> <p>0: This is the base physical address of a single, contiguous physical output region. This could be mapped to DRAM or to MMIO, depending on the value.</p> <p>The base address should be aligned with the size of the region, such that none of the 1s in the mask value (Section 33.2.8.8) overlap with 1s in the base address. If the base is not aligned, an operational error will result (see Section 33.3.10).</p> <p>1: The base physical address of the current ToPA table. The address must be 4K aligned. Writing an address in which bits 11:7 are non-zero will not cause a #GP, but an operational error will be signaled once <code>TraceEn</code> is set. See “ToPA Errors” in Section 33.2.7.2, as well as Section 33.3.10.</p>
63:MAXPHYADDR	Reserved	0	Must be 0.

33.2.8.8 IA32_RTIT_OUTPUT_MASK_PTRS MSR

This MSR holds any mask or pointer values needed to indicate where the next byte of trace output should be written. The meaning of the values held in this MSR depend on whether the ToPA output mechanism is in use. See Section 33.2.7.2 for details.

The processor updates this MSR while when packet generation is enabled, and those updates are asynchronous to instruction execution. Therefore, the values in this MSR should be considered unreliable unless packet generation is disabled (`IA32_RTIT_CTL.TraceEn = 0`).

Accesses to this MSR are supported only if Intel PT output to memory is supported, hence when either `CPUID.(EAX=14H, ECX=0):ECX[bit 0]` or `CPUID.(EAX=14H, ECX=0):ECX[bit 2]` are set. Otherwise `WRMSR` or `RDMSR` cause a general-protection fault (#GP). If supported, this MSR can be written only when `IA32_RTIT_CTL.TraceEn` is 0; otherwise `WRMSR` causes a general-protection fault (#GP).

Table 33-9. IA32_RTIT_OUTPUT_MASK_PTRS MSR

Position	Bit Name	At Reset	Bit Description
6:0	LowerMask	7FH	Forced to 1, writes are ignored.
31:7	MaskOrTableOffset	0	<p>The use of this field depends on the value of IA32_RTIT_CTL.ToPA:</p> <p>0: This field holds bits 31:7 of the mask value for the single, contiguous physical output region. The size of this field indicates that regions can be of size 128B up to 4GB. This value (combined with the lower 7 bits, which are reserved to 1) will be ANDed with the OutputOffset field to determine the next write address. All 1s in this field should be consecutive and starting at bit 7, otherwise the region will not be contiguous, and an operational error (Section 33.3.10) will be signaled when TraceEn is set.</p> <p>1: This field holds bits 27:3 of the offset pointer into the current ToPA table. This value can be added to the IA32_RTIT_OUTPUT_BASE value to produce a pointer to the current ToPA table entry, which itself is a pointer to the current output region. In this scenario, the lower 7 reserved bits are ignored. This field supports tables up to 256 MBytes in size.</p>
63:32	OutputOffset	0	<p>The use of this field depends on the value of IA32_RTIT_CTL.ToPA:</p> <p>0: This is bits 31:0 of the offset pointer into the single, contiguous physical output region. This value will be added to the IA32_RTIT_OUTPUT_BASE value to form the physical address at which the next byte of packet output data will be written. This value must be less than or equal to the MaskOrTableOffset field, otherwise an operational error (Section 33.3.10) will be signaled when TraceEn is set.</p> <p>1: This field holds bits 31:0 of the offset pointer into the current ToPA output region. This value will be added to the output region base field, found in the current ToPA table entry, to form the physical address at which the next byte of trace output data will be written.</p> <p>This value must be less than the ToPA entry size, otherwise an operational error (Section 33.3.10) will be signaled when TraceEn is set.</p>

33.2.9 Interaction of Intel® Processor Trace and Other Processor Features

33.2.9.1 Intel® Transactional Synchronization Extensions (Intel® TSX)

The operation of Intel TSX is described in Chapter 14 of the Intel® 64 and IA-32 Architectures Software Developer’s Manual, Volume 1. For tracing purpose, packet generation does not distinguish between hardware lock elision (HLE) and restricted transactional memory (RTM), but speculative execution does have impacts on the trace output. Specifically, packets are generated as instructions complete, even for instructions in a transactional region that is later aborted. For this reason, debugging software will need indication of the beginning and end of a transactional region; this will allow software to understand when instructions are part of a transactional region and whether that region has been committed.

To enable this, TSX information is included in a MODE packet leaf. The mode bits in the leaf are:

- **InTX:** Set to 1 on an TSX transaction begin, and cleared on transaction commit or abort.
- **TXAbort:** Set to 1 only when InTX transitions from 1 to 0 on an abort. Cleared otherwise.

If BranchEn=1, this MODE packet will be sent each time the transaction status changes. See Table 33-10 for details.

Table 33-10. TSX Packet Scenarios with BranchEn=1

TSX Event	Instruction	Packets
Transaction Begin	Either XBEGIN or XACQUIRE lock (the latter if executed transactionally)	MODE(TXAbort=0, InTX=1), FUP(CurrentIP)
Transaction Commit	Either XEND or XRELEASE lock, if transactional execution ends. This happens only on the outermost commit	MODE(TXAbort=0, InTX=0), FUP(CurrentIP)

Table 33-10. TSX Packet Scenarios with BranchEn=1

TSX Event	Instruction	Packets
Transaction Abort	XABORT or other transactional abort	MODE(TXAbort=1, InTX=0), FUP(CurrentIP), TIP(TargetIP)
Other	One of the following: <ul style="list-style-type: none"> ▪ Nested XBEGIN or XACQUIRE lock ▪ An outer XACQUIRE lock that doesn't begin a transaction (InTX not set) ▪ Non-outermost XEND or XRELEASE lock 	None. No change to TSX mode bits for these cases.

The CurrentIP listed above is the IP of the associated instruction. The TargetIP is the IP of the next instruction to be executed; for HLE, this is the XACQUIRE lock; for RTM, this is the fallback handler.

Intel PT stores are non-transactional, and thus packet writes are not rolled back on TSX abort.

33.2.9.2 TSX and IP Filtering

A complication with tracking transactions is handling transactions that start or end outside of the tracing region. Transactions can't span across a change in ContextEn, because CPL changes and CR3 changes each cause aborts. But a transaction can start within the IP filter region and end outside it.

To assist the decoder handling this situation, MODE.TSX packets can be sent even if FilterEn=0, though there will be no FUP attached. Instead, they will merely serve to indicate to the decoder when transactions are active and when they are not. When tracing resumes (due to PacketEn=1), the last MODE.TSX preceding the TIP.PGE will indicate the current transaction status.

33.2.9.3 System Management Mode (SMM)

SMM code has special privileges that non-SMM code does not have. Intel Processor Trace can be used to trace SMM code, but special care is taken to ensure that SMM handler context is not exposed in any non-SMM trace collection. Additionally, packet output from tracing non-SMM code cannot be written into memory space that is either protected by SMRR or used by the SMM handler.

SMM is entered via a system management interrupt (SMI). SMI delivery saves the value of IA32_RTIT_CTL.TraceEn into SMRAM and then clears it, thereby disabling packet generation.

The saving and clearing of IA32_RTIT_CTL.TraceEn ensures two things:

1. All internally buffered packet data is flushed before entering SMM (see Section 33.2.8.2).
2. Packet generation ceases before entering SMM, so any tracing that was configured outside SMM does not continue into SMM. No SMM instruction pointers or other state will be exposed in the non-SMM trace.

When the RSM instruction is executed to return from SMM, the TraceEn value that was saved by SMI delivery is restored, allowing tracing to be resumed. As is done any time packet generation is enabled, ContextEn is re-evaluated, based on the values of CPL, CR3, etc., established by RSM.

Like other interrupts, delivery of an SMI produces a FUP containing the IP of the next instruction to execute. By toggling TraceEn, SMI and RSM can produce TIP.PGD and TIP.PGE packets, respectively, indicating that tracing was disabled or re-enabled. See Table 33.7 for more information about packets entering and leaving SMM.

Although #SMI and RSM change CR3, PIP packets are not generated in these cases. With #SMI tracing is disabled before the CR3 change; with RSM TraceEn is restored after CR3 is written.

TraceEn must be cleared before executing RSM, otherwise it will cause a shutdown. Further, on processors that restrict use of Intel PT with LBRs (see Section 33.3.1.2), any RSM that results in enabling of both will cause a shutdown.

Intel PT can support tracing of System Transfer Monitor operating in SMM, see Section 33.6.

33.2.9.4 Virtual-Machine Extensions (VMX)

Initial implementations of Intel Processor Trace do not support tracing in VMX operation. Such processors indicate this by returning 0 for IA32_VMX_MISC[bit 14]. On these processors, execution of the VMXON instruction clears IA32_RTIT_CTL.TraceEn and any attempt to write IA32_RTIT_CTL in VMX operation causes a general-protection exception (#GP).

Processors that support Intel Processor Trace in VMX operation return 1 for IA32_VMX_MISC[bit 14]. Details of tracing in VMX operation are described in Section 33.4.2.26.

33.2.9.5 Intel® Software Guard Extensions (Intel® SGX)

Intel SGX provides an application with the ability to instantiate a protective container (an enclave) with confidentiality and integrity (see the Intel® 64 and IA-32 Architectures Software Developer's Manual, Volume 3D). On a processor with both Intel PT and Intel SGX enabled, when executing code within a production enclave, no control flow packets are produced by Intel PT. An enclave entry will clear ContextEn, thereby blocking control flow packet generation. A TIP.PGD packet will be generated if PacketEn=1 at the time of the entry.

Upon enclave exit, ContextEn will no longer be forced to 0. If other enables are set at the time, a TIP.PGE may be generated to indicate that tracing is resumed.

During the enclave execution, Intel PT remains enabled, and periodic or timing packets such as PSB, TSC, MTC, or CBR can still be generated. No IPs or other architectural state will be exposed.

For packet generation examples on enclave entry or exit, see Section 33.7.

Debug Enclaves

Intel SGX allows an enclave to be configured with relaxed protection of confidentiality for debug purposes, see the Intel® 64 and IA-32 Architectures Software Developer's Manual, Volume 3D. In a debug enclave, Intel PT continues to function normally. Specifically, ContextEn is not impacted by an enclave entry or exit. Hence, the generation of ContextEn-dependent packets within a debug enclave is allowed.

33.2.9.6 SENTER/ENTERACCS and ACM

GETSEC[SENDER] and GETSEC[ENTERACCS] instructions clear TraceEn, and it is not restored when those instruction complete. SENTER also causes TraceEn to be cleared on other logical processors when they rendezvous and enter the SENTER sleep state. In these two cases, the disabling of packet generation is not guaranteed to flush internally buffered packets. Some packets may be dropped.

When executing an authenticated code module (ACM), packet generation is silently disabled during ACRAM setup. TraceEn will be cleared, but no TIP.PGD packet is generated. After completion of the module, the TraceEn value will be restored. There will be no TIP.PGE packet, but timing packets, like TSC and CBR, may be produced.

33.2.9.7 Intel® Memory Protection Extensions (Intel® MPX)

Bounds exceptions (#BR) caused by Intel MPX are treated like other exceptions, producing FUP and TIP packets that indicate the source and destination IPs.

33.3 CONFIGURATION AND PROGRAMMING GUIDELINE

33.3.1 Detection of Intel Processor Trace and Capability Enumeration

Processor support for Intel Processor Trace is indicated by CPUID.(EAX=07H,ECX=0H):EBX[bit 25] = 1. CPUID function 14H is dedicated to enumerate the resource and capability of processors that report CPUID.(EAX=07H,ECX=0H):EBX[bit 25] = 1. Different processor generations may have architecturally-defined variation in capabilities. Table 33-11 describes details of the enumerable capabilities that software must use across generations of processors that support Intel Processor Trace.

Table 33-11. CPUID Leaf 14H Enumeration of Intel Processor Trace Capabilities

CPUID.(EAX=14H,ECX=0)		Name	Description Behavior
Register	Bits		
EAX	31:0	Maximum valid sub-leaf Index	Specifies the index of the maximum valid sub-leaf for this CPUID leaf.
EBX	0	CR3 Filtering Support	1: Indicates that IA32_RTIT_CTL.CR3Filter can be set to 1, and that IA32_RTIT_CR3_MATCH MSR can be accessed. See Section 33.2.8. 0: Indicates that writes that set IA32_RTIT_CTL.CR3Filter to 1, or any access to IA32_RTIT_CR3_MATCH, will generate a #GP exception.
	1	Configurable PSB and Cycle-Accurate Mode Supported	1: (a) IA32_RTIT_CTL.PSBFreq can be set to a non-zero value, in order to select the preferred PSB frequency (see below for allowed values). (b) IA32_RTIT_STATUS.PacketByteCnt can be set to a non-zero value, and will be incremented by the processor when tracing to indicate progress towards the next PSB. If trace packet generation is enabled by setting TraceEn, a PSB will only be generated if PacketByteCnt=0. (c) IA32_RTIT_CTL.CYCEn can be set to 1 to enable Cycle-Accurate Mode. See Section 33.2.8. 0: (a) Any attempt to write a non-zero value to IA32_RTIT_CTL.PSBFreq or IA32_RTIT_STATUS.PacketByteCnt will generate a #GP exception. (b) If trace packet generation is enabled by setting TraceEn, a PSB is always generated. (c) Any attempt to write a non-zero value to IA32_RTIT_CTL.CYCEn or IA32_RTIT_CTL.CycThresh will generate a #GP exception.
	2	IP Filtering and TraceStop supported, and Preserve Intel PT MSRs across warm reset	1: (a) IA32_RTIT_CTL provides at one or more ADDRn_CFG field to configure the corresponding address range MSRs for IP Filtering or IP TraceStop. Each ADDRn_CFG field accepts a value in the range of 0:2 inclusive. The number of ADDRn_CFG fields is reported by CPUID.(EAX=14H, ECX=1):EAX.RANGECNT[2:0]. (b) At least one register pair IA32_RTIT_ADDRn_A and IA32_RTIT_ADDRn_B are provided to configure address ranges for IP filtering or IP TraceStop. (c) On warm reset, all Intel PT MSRs will retain their pre-reset values, though IA32_RTIT_CTL.TraceEn will be cleared. The Intel PT MSRs are listed in Section 33.2.8. 0: (a) An Attempt to write IA32_RTIT_CTL.ADDRn_CFG with non-zero encoding values will cause #GP. (b) Any access to IA32_RTIT_ADDRn_A and IA32_RTIT_ADDRn_B, will generate a #GP exception. (c) On warm reset, all Intel PT MSRs will be cleared.
	3	MTC Supported	1: IA32_RTIT_CTL.MTCEn can be set to 1, and MTC packets will be generated. See Section 33.2.8. 0: An attempt to set IA32_RTIT_CTL.MTCEn or IA32_RTIT_CTL.MTCFreq to a non-zero value will generate a #GP exception.
	4	PTWRITE Supported	1: Writes can set IA32_RTIT_CTL[12] (PTWEn) and IA32_RTIT_CTL[5] (FUPonPTW), and PTWRITE can generate packets. 0: Writes that set IA32_RTIT_CTL[12] or IA32_RTIT_CTL[5] will generate a #GP exception, and PTWRITE will #UD fault.
5	Power Event Trace Supported	1: Writes can set IA32_RTIT_CTL[4] (PwrEvtEn), enabling Power Event Trace packet generation. 0: Writes that set IA32_RTIT_CTL[4] will generate a #GP exception.	

Table 33-11. CPUID Leaf 14H Enumeration of Intel Processor Trace Capabilities (Contd.)

CPUID.(EAX=14H,ECX=0)		Name	Description Behavior
Register	Bits		
	6	PSB and PMI Preservation Supported	1: Writes can set IA32_RTIT_CTL[56] (InjectPsbPmiOnEnable), enabling the processor to set IA32_RTIT_STATUS[7] (PendToPaPMI) and/or IA32_RTIT_STATUS[6] (PendPSB) in order to preserve ToPA PMIs and/or PSBs otherwise lost due to Intel PT disable. Writes can also set PendToPAPMI and PendPSB. 0: Writes that set IA32_RTIT_CTL[56], IA32_RTIT_STATUS[7], or IA32_RTIT_STATUS[6] will generate a #GP exception.
	7	Event Trace Supported	1: Writes can set IA32_RTIT_CTL[31] (EventEn), enabling Event Trace packet generation. 0: Writes that set IA32_RTIT_CTL[31] will generate a #GP exception.
	8	TNT Disable Supported	1: Writes can set IA32_RTIT_CTL[55] (DisTNT), disabling TNT packet generation. 0: Writes that set IA32_RTIT_CTL[55] will generate a #GP exception.
	31:9	Reserved	
ECX	0	ToPA Output Supported	1: Tracing can be enabled with IA32_RTIT_CTL.ToPA = 1, hence utilizing the ToPA output scheme (Section 33.2.7.2) IA32_RTIT_OUTPUT_BASE and IA32_RTIT_OUTPUT_MASK_PTRS MSRs can be accessed. 0: Unless CPUID.(EAX=14H, ECX=0):ECX.SNGLRNGOUT[bit 2] = 1. writes to IA32_RTIT_OUTPUT_BASE or IA32_RTIT_OUTPUT_MASK_PTRS. MSRs will generate a #GP exception.
	1	ToPA Tables Allow Multiple Output Entries	1: ToPA tables can hold any number of output entries, up to the maximum allowed by the MaskOrTableOffset field of IA32_RTIT_OUTPUT_MASK_PTRS. 0: ToPA tables can hold only one output entry, which must be followed by an END=1 entry which points back to the base of the table. Further, ToPA PMIs will be delivered before the region is filled. See ToPA PMI in Section 33.2.7.2. If there is more than one output entry before the END entry, or if the END entry has the wrong base address, an operational error will be signaled (see “ToPA Errors” in Section 33.2.7.2).
	2	Single-Range Output Supported	1: Enabling tracing (TraceEn=1) with IA32_RTIT_CTL.ToPA=0 is supported. 0: Unless CPUID.(EAX=14H, ECX=0):ECX.TOPAOUT[bit 0] = 1. writes to IA32_RTIT_OUTPUT_BASE or IA32_RTIT_OUTPUT_MASK_PTRS. MSRs will generate a #GP exception.
	3	Output to Trace Transport Subsystem Supported	1: Setting IA32_RTIT_CTL.FabricEn to 1 is supported. 0: IA32_RTIT_CTL.FabricEn is reserved. Write 1 to IA32_RTIT_CTL.FabricEn will generate a #GP exception.
	30:4	Reserved	
	31	IP Payloads are LIP	1: Generated packets which contain IP payloads have LIP values, which include the CS base component. 0: Generated packets which contain IP payloads have RIP values, which are the offset from CS base.
EDX	31:0	Reserved	

If CPUID.(EAX=14H, ECX=0):EAX reports a non-zero value, additional capabilities of Intel Processor Trace are described in the sub-leaves of CPUID leaf 14H.

Table 33-12. CPUID Leaf 14H, sub-leaf 1H Enumeration of Intel Processor Trace Capabilities

CPUID.(EAX=14H,ECX=1)		Name	Description Behavior
Register	Bits		
EAX	2:0	Number of Address Ranges	A non-zero value specifies the number ADDRn_CFG field supported in IA32_RTIT_CTL and the number of register pair IA32_RTIT_ADDRn_A/IA32_RTIT_ADDRn_B supported for IP filtering and IP TraceStop. NOTE: Currently, no processors support more than 4 address ranges.
	15:3	Reserved	
	31:16	Bitmap of supported MTC Period Encodings	The non-zero bits indicate the map of supported encoding values for the IA32_RTIT_CTL.MTCFreq field. This applies only if CPUID.(EAX=14H, ECX=0):EBX[bit 3] = 1 (MTC Packet generation is supported), otherwise the MTCFreq field is reserved to 0. Each bit position in this field represents 1 encoding value in the 4-bit MTCFreq field (ie, bit 0 is associated with encoding value 0). For each bit: 1: MTCFreq can be assigned the associated encoding value. 0: MTCFreq cannot be assigned to the associated encoding value. A write to IA32_RTIT_CTL.MTCFreq with unsupported encoding will cause #GP fault.
EBX	15:0	Bitmap of supported Cycle Threshold values	The non-zero bits indicate the map of supported encoding values for the IA32_RTIT_CTL.CycThresh field. This applies only if CPUID.(EAX=14H, ECX=0):EBX[bit 1] = 1 (Cycle-Accurate Mode is Supported), otherwise the CycThresh field is reserved to 0. See Section 33.2.8. Each bit position in this field represents 1 encoding value in the 4-bit CycThresh field (ie, bit 0 is associated with encoding value 0). For each bit: 1: CycThresh can be assigned the associated encoding value. 0: CycThresh cannot be assigned to the associated encoding value. A write to CycThresh with unsupported encoding will cause #GP fault.
	31:16	Bitmap of supported Configurable PSB Frequency encoding	The non-zero bits indicate the map of supported encoding values for the IA32_RTIT_CTL.PSBFreq field. This applies only if CPUID.(EAX=14H, ECX=0):EBX[bit 1] = 1 (Configurable PSB is supported), otherwise the PSBFreq field is reserved to 0. See Section 33.2.8. Each bit position in this field represents 1 encoding value in the 4-bit PSBFreq field (ie, bit 0 is associated with encoding value 0). For each bit: 1: PSBFreq can be assigned the associated encoding value. 0: PSBFreq cannot be assigned to the associated encoding value. A write to PSBFreq with unsupported encoding will cause #GP fault.
ECX	31:0	Reserved	
EDX	31:0	Reserved	

33.3.1.1 Packet Decoding of RIP versus LIP

FUP, TIP, TIP.PGE, and TIP.PGE packets can contain an instruction pointer (IP) payload. On some processor generations, this payload will be an effective address (RIP), while on others this will be a linear address (LIP). In the former case, the payload is the offset from the current CS base address, while in the latter it is the sum of the offset and the CS base address (Note that in real mode, the CS base address is the value of CS<<4, while in protected mode the CS base address is the base linear address of the segment indicated by the CS register.). Which IP type is in use is indicated by enumeration (see CPUID.(EAX=14H, ECX=0):ECX.LIP[bit 31] in Table 33-11).

For software that executes while the CS base address is 0 (including all software executing in 64-bit mode), the difference is indistinguishable. A trace decoder must account for cases where the CS base address is not 0 and the resolved LIP will not be evident in a trace generated on a CPU that enumerates use of RIP. This is likely to cause problems when attempting to link the trace with the associated binaries.

Note that IP comparison logic, for IP filtering and TraceStop range calculation, is based on the same IP type as these IP packets. For processors that output RIP, the IP comparison mechanism is also based on RIP, and hence on those processors RIP values should be written to IA32_RTIT_ADDRn_[AB] MSRs. This can produce differing behavior if the same trace configuration setting is run on processors reporting different IP types, i.e., CPUID.(EAX=14H, ECX=0):ECX.LIP[bit 31]. Care should be taken to check CPUID when configuring IP filters.

33.3.1.2 Model Specific Capability Restrictions

Some processor generations impose restrictions that prevent use of LBRs/BTS/BTM/LEAs when software has enabled tracing with Intel Processor Trace. On these processors, when TraceEn is set, updates of LBR, BTS, BTM, LEAs are suspended but the states of the corresponding IA32_DEBUGCTL control fields remained unchanged as if it were still enabled. When TraceEn is cleared, the LBR array is reset, and LBR/BTS/BTM/LEAs updates will resume. Further, reads of these registers will return 0, and writes will be dropped.

The list of MSRs whose updates/accesses are restricted follows.

- MSR_LASTBRANCH_x_TO_IP, MSR_LASTBRANCH_x_FROM_IP, MSR_LBR_INFO_x, MSR_LASTBRANCH_TOS
- MSR_LER_FROM_LIP, MSR_LER_TO_LIP
- MSR_LBR_SELECT

For processors with CPUID DisplayFamily_DisplayModel signatures of 06_3DH, 06_47H, 06_4EH, 06_4FH, 06_56H, and 06_5EH, the use of Intel PT and LBRs are mutually exclusive.

33.3.2 Enabling and Configuration of Trace Packet Generation

To configure trace packets, enable packet generation, and capture packets, software starts with using CPUID instruction to detect its feature flag, CPUID.(EAX=07H, ECX=0H):EBX[bit 25] = 1; followed by enumerating the capabilities described in Section 33.3.1.

Based on the capability queried from Section 33.3.1, software must configure a number of model-specific registers. This section describes programming considerations related to those MSRs.

33.3.2.1 Enabling Packet Generation

When configuring and enabling packet generation, the IA32_RTIT_CTL MSR should be written after any other Intel PT MSRs have been written, since writes to the other configuration MSRs cause a general-protection fault (#GP) if TraceEn = 1. If a prior trace collection context is not being restored, then software should first clear IA32_RTIT_STATUS. This is important since the Stopped, and Error fields are writable; clearing the MSR clears any values that may have persisted from prior trace packet collection contexts. See Section 33.2.8.2 for details of packets generated by setting TraceEn to 1.

If setting TraceEn to 1 causes an operational error (see Section 33.3.10), there may be a delay after the WRMSR completes before the error is signaled in the IA32_RTIT_STATUS MSR.

While packet generation is enabled, the values of some configuration MSRs (e.g., IA32_RTIT_STATUS and IA32_RTIT_OUTPUT_*) are transient, and reads may return values that are out of date. Only after packet generation is disabled (by clearing TraceEn) do reads of these MSRs return reliable values.

33.3.2.2 Disabling Packet Generation

After disabling packet generation by clearing IA32_RTIT_CTL, it is advisable to read the IA32_RTIT_STATUS MSR (Section 33.2.8.4):

- If the Error bit is set, an operational error was encountered, and the trace is most likely compromised. Software should check the source of the error (by examining the output MSR values), correct the source of the problem, and then attempt to gather the trace again. For details on operational errors, see Section 33.3.10. Software should clear IA32_RTIT_STATUS.Error before re-enabling packet generation.
- If the Stopped bit is set, software execution encountered an IP TraceStop (see Section 33.2.5.3) or the ToPA Stop condition (see “ToPA STOP” in Section 33.2.7.2) before packet generation was disabled.

33.3.3 Flushing Trace Output

Packets are first buffered internally and then written out asynchronously. To collect packet output for post-processing, a collector needs first to ensure that all packet data has been flushed from internal buffers. Software can ensure this by stopping packet generation by clearing IA32_RTIT_CTL.TraceEn (see “Disabling Packet Generation” in Section 33.2.8.2).

When software clears IA32_RTIT_CTL.TraceEn to flush out internally buffered packets, the logical processor issues an SFENCE operation which ensures that WC trace output stores will be ordered with respect to the next store, or serializing operation. A subsequent read from the same logical processor will see the flushed trace data, while a read from another logical processor should be preceded by a store, fence, or architecturally serializing operation on the tracing logical processor.

When the flush operations complete, the IA32_RTIT_OUTPUT_* MSR values indicate where the trace ended. While TraceEn is set, these MSRs may hold stale values. Further, if a ToPA region with INT=1 is filled, meaning a ToPA PMI has been triggered, IA32_PERF_GLOBAL_STATUS.Trace_ToPA_PMI[55] will be set by the time the flush completes.

33.3.4 Warm Reset

The MSRs software uses to program Intel Processor Trace are cleared after a power-on RESET (or cold RESET). On a warm RESET, the contents of those MSRs can retain their values from before the warm RESET with the exception that IA32_RTIT_CTL.TraceEn will be cleared (which may have the side effect of clearing some bits in IA32_RTIT_STATUS).

33.3.5 Context Switch Consideration

To facilitate construction of instruction execution traces at the granularity of a software process or thread context, software can save and restore the states of the trace configuration MSRs across the process or thread context switch boundary. The principle is the same as saving and restoring the typical architectural processor states across context switches.

33.3.5.1 Manual Trace Configuration Context Switch

The configuration can be saved and restored through a sequence of instructions of RDMSR, management of MSR content and WRMSR. To stop tracing and to ensure that all configuration MSRs contain stable values, software must clear IA32_RTIT_CTL.TraceEn before reading any other trace configuration MSRs. The recommended method for saving trace configuration context manually follows:

1. RDMSR IA32_RTIT_CTL, save value to memory
2. WRMSR IA32_RTIT_CTL with saved value from RDMSR above and TraceEn cleared
3. RDMSR all other configuration MSRs whose values had changed from previous saved value, save changed values to memory

When restoring the trace configuration context, IA32_RTIT_CTL should be restored last:

1. Read saved configuration MSR values, aside from IA32_RTIT_CTL, from memory, and restore them with WRMSR
2. Read saved IA32_RTIT_CTL value from memory, and restore with WRMSR.

33.3.5.2 Trace Configuration Context Switch Using XSAVES/XRSTORS

On processors whose XSAVE feature set supports XSAVES and XRSTORS, the Trace configuration state can be saved using XSAVES and restored by XRSTORS, in conjunction with the bit field associated with supervisory state component in IA32_XSS. See Chapter 13, “Managing State Using the XSAVE Feature Set,” of Intel® 64 and IA-32 Architectures Software Developer’s Manual, Volume 1.

33.3.6 Cycle-Accurate Mode

Intel PT can be run in a cycle-accurate mode which enables CYC packets (see Section 33.4.2.14) that provide low-level information in the processor core clock domain. This cycle counter data in CYC packets can be used to compute IPC (Instructions Per Cycle), or to track wall-clock time on a fine-grain level.

To enable cycle-accurate mode packet generation, software should set IA32_RTIT_CTL.CYCEn=1. It is recommended that software also set TSCEn=1 anytime cycle-accurate mode is in use. With this, all CYC-eligible packets will be preceded by a CYC packet, the payload of which indicates the number of core clock cycles since the last CYC packet. In cases where multiple CYC-eligible packets are generated in a single cycle, only a single CYC will be generated before the CYC-eligible packets, otherwise each CYC-eligible packet will be preceded by its own CYC. The CYC-eligible packets are:

- TNT, TIP, TIP.PGE, TIP.PGD, MODE.EXEC, MODE.TSX, PIP, VMCS, OVF, MTC, TSC, PTWRITE, EXSTOP

TSC packets are generated when there is insufficient information to reconstruct wall-clock time, due to tracing being disabled (TriggerEn=0), or power down scenarios like a transition to a deep-sleep MWAIT C-state. In this case, the CYC that is generated along with the TSC will indicate the number of cycles actively tracing (those powered up, with TriggerEn=1) executed between the last CYC packet and the TSC packet. And hence the amount of time spent while tracing is inactive can be inferred from the difference in time between that expected based on the CYC value, and the actual time indicated by the TSC.

Additional CYC packets may be sent stand-alone, so that the processor can ensure that the decoder is aware of the number of cycles that have passed before the internal hardware counter wraps, or is reset due to other micro-architectural condition. There is no guarantee at what intervals these standalone CYC packets will be sent, except that they will be sent before the wrap occurs. An illustration is given below.

Example 33-1. An Illustrative CYC Packet Example

Time (cycles)	Instruction Snapshot	Generated Packets	Comment
x	call %eax	CYC(?), TIP	?Elapsed cycles from the previous CYC unknown
x + 2	call %ebx	CYC(2), TIP	1 byte CYC packet; 2 cycles elapsed from the previous CYC
x + 8	jnz Foo (not taken)	CYC(6)	1 byte CYC packet
x + 9	ret (compressed)		
x + 12	jnz Bar (taken)		
x + 16	ret (uncompressed)	TNT, CYC(8), TIP	1 byte CYC packet
x + 4111		CYC(4095)	2 byte CYC packet
x + 12305		CYC(8194)	3 byte CYC packet
x + 16332	mov cr3, %ebx	CYC(4027), PIP	2 byte CYC packet

33.3.6.1 Cycle Counter

The cycle counter is implemented in hardware (independent of the time stamp counter or performance monitoring counters), and is a simple incrementing counter that does not saturate, but rather wraps. The size of the counter is implementation specific.

The cycle counter is reset to zero any time that TriggerEn is cleared, and when a CYC packet is sent. The cycle counter will continue to count when ContextEn or FilterEn are cleared, and cycle packets will still be generated. It will not count during sleep states that result in Intel PT logic being powered-down, but will count up to the point where clocks are disabled, and resume counting once they are re-enabled.

33.3.6.2 Cycle Packet Semantics

Cycle-accurate mode adheres to the following protocol:

- All packets that precede a CYC packet represent instructions or events that took place before the CYC time.
- All packets that follow a CYC packet represent instructions or events that took place at the same time as, or after, the CYC time.
- The CYC-eligible packet that immediately follows a CYC packet represents an instruction or event that took place at the same time as the CYC time.

These items above give the decoder a means to apply CYC packets to a specific instruction in the assembly stream. Most packets represent a single instruction or event, and hence the CYC packet that precedes each of those packets represents the retirement time of that instruction or event. In the case of TNT packets, up to 6 conditional branches and/or compressed RETs may be contained in the packet. In this case, the preceding CYC packet provides the retirement time of the first branch in the packet. It is possible that multiple branches retired in the same cycle as that first branch in the TNT, but the protocol will not make that obvious. Also note that a MTC packet could be generated in the same cycle as the first JCC in the TNT packet. In this case, the CYC would precede both the MTC and the TNT, and apply to both.

Note that there are times when the cycle counter will stop counting, though cycle-accurate mode is enabled. After any such scenario, a CYC packet followed by TSC packet will be sent. See Section 33.8.3.2 to understand how to interpret the payload values

Multi-packet Instructions or Events

Some operations, such as interrupts or task switches, generate multiple packets. In these cases, multiple CYC packets may be sent for the operation, preceding each CYC-eligible packet in the operation. An example, using a task switch on a software interrupt, is shown below.

Example 33-2. An Example of CYC in the Presence of Multi-Packet Operations

Time (cycles)	Instruction Snapshot	Generated Packets
x	jnz Foo (not taken)	CYC(?)
x + 2	ret (compressed)	
x + 8	jnz Bar (taken)	
x + 9	jmp %eax	TNT, CYC(9), TIP
x + 12	jnz Bar (not taken)	CYC(3)
x + 32	int3 (task gate)	TNT, FUP, CYC(10), PIP, CYC(20), MODE.Exec, TIP

33.3.6.3 Cycle Thresholds

Software can opt to reduce the frequency of cycle packets, a trade-off to save bandwidth and intrusion at the expense of precision. This is done by utilizing a cycle threshold (see Section 33.2.8.2).

IA32_RTIT_CTL.CycThresh indicates to the processor the minimum number of cycles that must pass before the next CYC packet should be sent. If this value is 0, no threshold is used, and CYC packets can be sent every cycle in which a CYC-eligible packet is generated. If this value is greater than 0, the hardware will wait until the associated

number of cycles have passed since the last CYC packet before sending another. CPUID provides the threshold options for CycThresh, see Section 33.3.1.

Note that the cycle threshold does not dictate how frequently a CYC packet will be posted, it merely assigns the maximum frequency. If the cycle threshold is 16, a CYC packet can be posted no more frequently than every 16 cycles. However, once that threshold of 16 cycles has passed, it still requires a new CYC-eligible packet to be generated before a CYC will be inserted. Table 33-13 illustrates the threshold behavior.

Table 33-13. An Illustrative CYC Packet Example

Time (cycles)	Instruction Snapshot	Threshold			
		0	16	32	64
x	jmp %eax	CYC, TIP	CYC, TIP	CYC, TIP	CYC, TIP
x + 9	call %ebx	CYC, TIP	TIP	TIP	TIP
x + 15	call %ecx	CYC, TIP	TIP	TIP	TIP
x + 30	jmp %edx	CYC, TIP	CYC, TIP	TIP	TIP
x + 38	mov cr3, %eax	CYC, PIP	PIP	CYC, PIP	PIP
x + 46	jmp [%eax]	CYC, TIP	CYC, TIP	TIP	TIP
x + 64	call %edx	CYC, TIP	CYC, TIP	TIP	CYC, TIP
x + 71	jmp %edx	CYC, TIP	TIP	CYC, TIP	TIP

33.3.7 Decoder Synchronization (PSB+)

The PSB packet (Section 33.4.2.17) serves as a synchronization point for a trace-packet decoder. It is a pattern in the trace log for which the decoder can quickly scan to align packet boundaries. No legal packet combination can result in such a byte sequence. As such, it serves as the starting point for packet decode. To decode a trace log properly, the decoder needs more than simply to be aligned: it needs to know some state and potentially some timing information as well. The decoder should never need to retain any information (e.g., LastIP, call stack, compound packet event) across a PSB; all compound packet events will be completed before a PSB, and any compression state will be reset.

When a PSB packet is generated, it is followed by a PSBEND packet (Section 33.4.2.18). One or more packets may be generated in between those two packets, and these inform the decoder of the current state of the processor. These packets, known collectively as PSB+, should be interpreted as “status only”, since they do not imply any change of state at the time of the PSB, nor are they associated directly with any instruction or event. Thus, the normal binding and ordering rules that apply to these packets outside of PSB+ can be ignored when these packets are between a PSB and PSBEND. They inform the decoder of the state of the processor at the time of the PSB.

PSB+ can include:

- Timestamp (TSC), if IA32_RTIT_CTL.TSCEn=1.
- Timestamp-MTC Align (TMA), if IA32_RTIT_CTL.TSCEn=1 && IA32_RTIT_CTL.MTCEn=1.
- Paging Information Packet (PIP), if ContextEn=1 and IA32_RTIT_CTL.OS=1. The non-root bit (NR) is set if the logical processor is in VMX non-root operation and the “conceal VMX from PT” VM-execution control is 0.
- VMCS packet, if either the logical is in VMX root operation or the logical processor is in VMX non-root operation and the “conceal VMX from PT” VM-execution control is 0.
- Core Bus Ratio (CBR).
- MODE.TSX, if ContextEn=1 and BranchEn = 1.
- MODE.Exec, if PacketEn=1.
- Flow Update Packet (FUP), if PacketEn=1.

PSB is generated only when TriggerEn=1; hence PSB+ has the same dependencies. The ordering of packets within PSB+ is not fixed. Timing packets such as CYC and MTC may be generated between PSB and PSBEND, and their meanings are the same as outside PSB+.

A PSB+ can be lost in some scenarios. If IA32_RTIT_STATUS.TriggerEn is cleared just as the PSB threshold is reached, e.g., due to TraceEn being cleared, the PSB+ may not be generated. On processors that support PSB preservation (CPUID.(EAX=14H, ECX=0):EBX[bit 6] = 1), setting IA32_RTIT_CTL.InjectPsbPmiOnEnable[56] = 1 will ensure that a PSB+ that is pending at the time PT is disabled will be recorded by setting IA32_RTIT_STATUS.PendPSB[6] = 1. A PSB will be inserted, and PendPSB cleared, when PT is later re-enabled while PendPSB = 1.

Note that an overflow can occur during PSB+, and this could cause the PSBEND packet to be lost. For this reason, the OVF packet should also be viewed as terminating PSB+. If IA32_RTIT_STATUS.TriggerEn is cleared just as the PSB threshold is reached, the PSB+ may not be generated. TriggerEn can be cleared by a WRMSR that clears IA32_RTIT_CTL.TraceEn, a VM exit that clears IA32_RTIT_CTL.TraceEn, an #SMI, or any time that either IA32_RTIT_STATUS.Stopped is set (e.g., by a TraceStop or ToPA stop condition) or IA32_RTIT_STATUS.Error is set (e.g., by an Intel PT output error). On processors that support PSB preservation (CPUID.(EAX=14H, ECX=0):EBX[bit 6] = 1), setting IA32_RTIT_CTL.InjectPsbPmiOnEnable[56] = 1 will ensure that a PSB+ that is pending at the time PT is disabled will be recorded by setting IA32_RTIT_STATUS.PendPSB[6] = 1. A PSB will then be pended when the saved PT context is later restored.

33.3.8 Internal Buffer Overflow

In the rare circumstances when new packets need to be generated but the processor's dedicated internal buffers are all full, an "internal buffer overflow" occurs. On such an overflow packet generation ceases (as packets would need to enter the processor's internal buffer) until the overflow resolves. Once resolved, packet generation resumes.

When the buffer overflow is cleared, an OVF packet (Section 33.4.2.16) is generated, and the processor ensures that packets which follow the OVF are not compressed (IP compression or RET compression) against packets that were lost.

If IA32_RTIT_CTL.BranchEn = 1, the OVF packet will be followed by a FUP if the overflow resolves while PacketEn=1. If the overflow resolves while PacketEn = 0 no packet is generated, but a TIP.PGE will naturally be generated later, once PacketEn = 1. The payload of the FUP or TIP.PGE will be the Current IP of the first instruction upon which tracing resumes after the overflow is cleared. If the overflow resolves while PacketEn=1, only timing packets may come between the OVF and the FUP. If the overflow resolves while PacketEn=0, any other packets that are not dependent on PacketEn may come between the OVF and the TIP.PGE.

33.3.8.1 Overflow Impact on Enables

The address comparisons to ADDRn ranges, for IP filtering and TraceStop (Section 33.2.5.3), continue during a buffer overflow, and TriggerEn, ContextEn, and FilterEn may change during a buffer overflow. Like other packets, however, any TIP.PGE or TIP.PGD packets that would have been generated will be lost. Further, IA32_RTIT_STATUS.PacketByteCnt will not increment, since it is only incremented when packets are generated.

If a TraceStop event occurs during the buffer overflow, IA32_RTIT_STATUS.Stopped will still be set, tracing will cease as a result. However, the TraceStop packet, and any TIP.PGD that result from the TraceStop, may be dropped.

33.3.8.2 Overflow Impact on Timing Packets

Any timing packets that are generated during a buffer overflow will be dropped. If only a few MTC packets are dropped, a decoder should be able to detect this by noticing that the time value in the first MTC packet after the buffer overflow incremented by more than one. If the buffer overflow lasted long enough that 256 MTC packets are lost (and thus the MTC packet 'wraps' its 8-bit CTC value), then the decoder may be unable to properly understand the trace. This is not an expected scenario. No CYC packets are generated during overflow, even if the cycle counter wraps.

Note that, if cycle-accurate mode is enabled, the OVF packet will generate a CYC packet. Because the cycle counter counts during overflows, this CYC packet can provide the duration of the overflow. However, there is a risk that the cycle counter wrapped during the overflow, which could render this CYC misleading.

33.3.9 TNT Disable

Software can opt to omit TNT packets from control flow trace (BranchEn=1) by setting IA32_RTIT_CTL.DisTNT[bit 55]. This can dramatically reduce trace size. Results will vary by workload, but trace size reductions of 40-75% are typical, which will have a corresponding reduction in performance overhead and memory bandwidth consumption from Intel PT. However, omitting TNT packets means the decoder is not able to follow the full control flow trace, since conditional branch and compressed RET results won't be known. Thus, TNT Disable should be employed only for usages that do not depend on full control flow trace.

NOTE

To avoid loss of RET results with TNT Disable, software may wish to disable RET compression by setting IA32_RTIT_CTL.DisRETC[bit 11].

33.3.10 Operational Errors

Errors are detected as a result of packet output configuration problems, which can include output alignment issues, ToPA reserved bit violations, or overlapping packet output with restricted memory. See “ToPA Errors” in Section 33.2.7.2 for details on ToPA errors, and Section 33.2.7.4 for details on restricted memory errors. Operational errors are only detected and signaled when TraceEn=1.

When an operational error is detected, tracing is disabled and the error is logged. Specifically, IA32_RTIT_STATUS.Error is set, which will cause IA32_RTIT_STATUS.TriggerEn to be 0. This will disable generation of all packets. Some causes of operational errors may lead to packet bytes being dropped.

It should be noted that the timing of error detection may not be predictable. Errors are signaled when the processor encounters the problematic configuration. This could be as soon as packet generation is enabled but could also be later when the problematic entry or field needs to be used.

Once an error is signaled, software should disable packet generation by clearing TraceEn, diagnose and fix the error condition, and clear IA32_RTIT_STATUS.Error. At this point, packet generation can be re-enabled.

33.4 TRACE PACKETS AND DATA TYPES

This section details the data packets generated by Intel Processor Trace. It is useful for developers writing the interpretation code that will decode the data packets and apply it to the traced source code.

33.4.1 Packet Relationships and Ordering

This section introduces the concept of packet “binding”, which involves determining the IP in a binary disassembly at which the change indicated by a given packet applies. Some packets have the associated IP as the payload (FUP, TIP), while for others the decoder need only search for the next instance of a particular instruction (or instructions) to bind the packet (TNT). However, in many cases, the decoder will need to consider the relationship between packets, and to use this packet context to determine how to bind the packet.

Section 33.4.1.1 below provides detailed descriptions of the packets, including how packets bind to IPs in the disassembly, to other packets, or to nothing at all. Many packets listed are simple to bind, because they are generated in only a few scenarios. Those that require more consideration are typically part of “compound packet events”, such as interrupts, exceptions, and some instructions, where multiple packets are generated by a single operation (instruction or event). These compound packet events frequently begin with a FUP to indicate the source address (if it is not clear from the disassembly), and are concluded by a TIP or TIP.PGD packet that indicates the destination address (if one is provided). In this scenario, the FUP is said to be “coupled” with the TIP packet.

Other packets could be in between the coupled FUP and TIP packet. Timing packets, such as TSC, MTC, CYC, or CBR, could arrive at any time, and hence could intercede in a compound packet event. If an operation changes CR3 or the processor’s mode of execution, a state update packet (i.e., PIP or MODE) is generated. The state changes indicated by these intermediate packets should be applied at the IP of the TIP* packet. A summary of compound packet events is provided in Table 33-14; see Section 33.4.1.1 for more per-packet details and Section 33.7 for more detailed packet generation examples.

Table 33-14. Compound Packet Event Summary

Event Type	Beginning	Middle	End	Comment
Unconditional, uncompressed control-flow transfer	FUP or none	Any combination of PIP, VMCS, MODE.Exec, or none	TIP or TIP.PGD	FUP only for asynchronous events. Order of middle packets may vary. PIP/VMCS/MODE only if the operation modifies the state tracked by these respective packets.
TSX Update	MODE.TSX, and (FUP or none)	None	TIP, TIP.PGD, or none	FUP TIP/TIP.PGD only for TSX abort cases.
Overflow	OVF	PSB, PSBEND, or none	FUP or TIP.PGE	FUP if overflow resolves while ContextEn=1, else TIP.PGE.

33.4.1.1 Packet Blocks

Packet blocks are a means to dump one or more groups of state values. Packet blocks begin with a Block Begin Packet (BBP), which indicates what type of state is held within the block. Following each BBP there may be one or more Block Item Packets (BIPs), which contain the state values. The block is terminated by either a Block End Packet (BEP) or another BBP indicating the start of a new block.

The BIP packet includes an ID value that, when combined with the Type field from the BBP that preceded it, uniquely identifies the state value held in the BIP payload. The size of each BIP packet payload is provided by the Size field in the preceding BBP packet.

Each block type can have up to 32 items defined for it. There is no guarantee, however, that each block of that type will hold all 32 items. For more details on which items to expect, see documentation on the specific block type of interest.

See the BBP packet description (Section 33.4.2.26) for details on packet block generation scenarios.

Packet blocks are entirely generated within an instruction or between instructions, which dictates the types of packets (aside from BIPs) that may be seen within a packet block. Packets that indicate control flow changes, or other indication of instruction completion, cannot be generated within a block. These are listed in the following table. Other packets, including timing packets, may occur between BBP and BEP.

Table 33-15. Packets Forbidden Between BBP and BEP

TNT
TIP, TIP.PGE, TIP.PGD
MODE.Exec, MODE.TSX
PIP, VMCS
TraceStop
PSB, PSBEND
PTW
MWAIT

It is possible to encounter an internal buffer overflow in the middle of a block. In such a case, it is guaranteed that packet generation will not resume in the middle of a block, and hence the OVF packet terminates the current block. Depending on the duration of the overflow, subsequent blocks may also be lost.

Decoder Implications

When a Block Begin Packet (BBP) is encountered, the decoder will need to decode some packets within the block differently from those outside a block. The Block Item Packet (BIP) header byte has the same encoding as a TNT packet outside of a block, but must be treated as a BIP header (with following payload) within one.

When an OVF packet is encountered, the decoder should treat that as a block ending condition. Packet generation will not resume within a block.

33.4.2 Packet Definitions

The following description of packet definitions are in tabular format. Figure 33-3 explains how to interpret them. Packet bits listed as "RSVD" are not guaranteed to be 0.

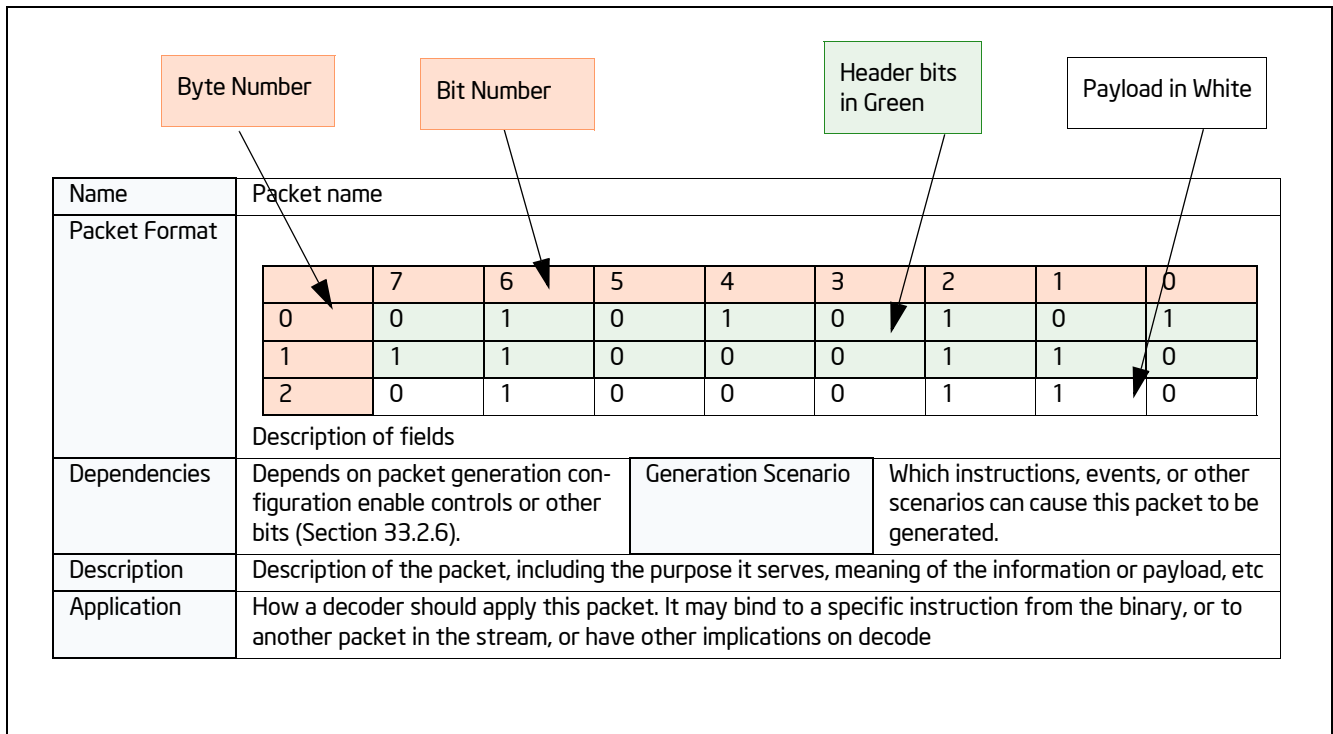

Figure 33-3. Interpreting Tabular Definition of Packet Format

33.4.2.1 Taken/Not-taken (TNT) Packet

Table 33-16. TNT Packet Definition

Name	Taken/Not-taken (TNT) Packet									
Packet Format										
		7	6	5	4	3	2	1	0	
	0	1	B ₁	B ₂	B ₃	B ₄	B ₅	B ₆	0	Short TNT
	B ₁ ...B _N represent the last N conditional branch or compressed RET (Section 33.4.2.2) results, such that B ₁ is oldest and B _N is youngest. The short TNT packet can contain from 1 to 6 TNT bits. The long TNT packet can contain from 1 to 47 TNT bits.									
		7	6	5	4	3	2	1	0	
	0	0	0	0	0	0	0	1	0	Long TNT
	1	1	0	1	0	0	0	1	1	
	2	B ₄₀	B ₄₁	B ₄₂	B ₄₃	B ₄₄	B ₄₅	B ₄₆	B ₄₇	
	3	B ₃₂	B ₃₃	B ₃₄	B ₃₅	B ₃₆	B ₃₇	B ₃₈	B ₃₉	
	4	B ₂₄	B ₂₅	B ₂₆	B ₂₇	B ₂₈	B ₂₉	B ₃₀	B ₃₁	
	5	B ₁₆	B ₁₇	B ₁₈	B ₁₉	B ₂₀	B ₂₁	B ₂₂	B ₂₃	
	6	B ₈	B ₉	B ₁₀	B ₁₁	B ₁₂	B ₁₃	B ₁₄	B ₁₅	
	7	1	B ₁	B ₂	B ₃	B ₄	B ₅	B ₆	B ₇	
	Irrespective of how many TNT bits is in a packet, the last valid TNT bit is followed by a trailing 1, or Stop bit, as shown above. If the TNT packet is not full (fewer than 6 TNT bits for the Short TNT, or fewer than 47 TNT bits for the Long TNT), the Stop bit moves up, and the trailing bits of the packet are filled with 0s. Examples of these “partial TNTs” are shown below. An implementation may choose to use long TNTs, short TNTs, or both.									
		7	6	5	4	3	2	1	0	
	0	0	0	1	B ₁	B ₂	B ₃	B ₄	0	Short TNT
		7	6	5	4	3	2	1	0	
	0	0	0	0	0	0	0	1	0	Long TNT
	1	1	0	1	0	0	0	1	1	
	2	B ₂₄	B ₂₅	B ₂₆	B ₂₇	B ₂₈	B ₂₉	B ₃₀	B ₃₁	
	3	B ₁₆	B ₁₇	B ₁₈	B ₁₉	B ₂₀	B ₂₁	B ₂₂	B ₂₃	
	4	B ₈	B ₉	B ₁₀	B ₁₁	B ₁₂	B ₁₃	B ₁₄	B ₁₅	
	5	1	B ₁	B ₂	B ₃	B ₄	B ₅	B ₆	B ₇	
	6	0	0	0	0	0	0	0	0	
	7	0	0	0	0	0	0	0	0	
Dependencies	PacketEn && ~IA32_RTIT_CTL.DisTNT			Generation Scenario		On a conditional branch or compressed RET, if it fills the TNT. Also, partial TNTs may be generated at any time, as a result of other packets being generated, or certain micro-architectural conditions occurring, before the TNT is full.				

Table 33-16. TNT Packet Definition (Contd.)

Description	<p>Provides the taken/not-taken results for the last 1..6 (Short TNT) or 1..47 (Long TNT) conditional branches (Jcc, J*CXZ, or LOOP) or compressed RETs (Section 33.4.2.2). The TNT payload bits should be interpreted as follows:</p> <ul style="list-style-type: none"> ▪ 1 indicates a taken conditional branch, or a compressed RET ▪ 0 indicates a not-taken conditional branch <p>TNT payload bits are stored internal to the processor in a TNT buffer, until either the buffer is filled or another packet is to be generated. In either case a TNT packet holding the buffered bits will be emitted, and the TNT buffer will be marked as empty.</p>
Application	<p>Each valid payload bit (that is, bits between the header bits and the trailing Stop bit) applies to an upcoming conditional branch or RET instruction. Once a decoder consumes a TNT packet with N valid payload bits, these bits should be applied to (and hence provide the destination for) the next N conditional branches or RETs.</p>

33.4.2.2 Target IP (TIP) Packet

Table 33-17. IP Packet Definition

Name	Target IP (TIP) Packet																																																																																												
Packet Format	<table border="1" style="width: 100%; border-collapse: collapse;"> <thead> <tr> <th style="width: 10%;"></th> <th style="width: 10%;">7</th> <th style="width: 10%;">6</th> <th style="width: 10%;">5</th> <th style="width: 10%;">4</th> <th style="width: 10%;">3</th> <th style="width: 10%;">2</th> <th style="width: 10%;">1</th> <th style="width: 10%;">0</th> </tr> </thead> <tbody> <tr> <td>0</td> <td colspan="3">IPBytes</td> <td>0</td> <td>1</td> <td>1</td> <td>0</td> <td>1</td> </tr> <tr> <td>1</td> <td colspan="8">TargetIP[7:0]</td> </tr> <tr> <td>2</td> <td colspan="8">TargetIP[15:8]</td> </tr> <tr> <td>3</td> <td colspan="8">TargetIP[23:16]</td> </tr> <tr> <td>4</td> <td colspan="8">TargetIP[31:24]</td> </tr> <tr> <td>5</td> <td colspan="8">TargetIP[39:32]</td> </tr> <tr> <td>6</td> <td colspan="8">TargetIP[47:40]</td> </tr> <tr> <td>7</td> <td colspan="8">TargetIP[55:48]</td> </tr> <tr> <td>8</td> <td colspan="8">TargetIP[63:56]</td> </tr> </tbody> </table>				7	6	5	4	3	2	1	0	0	IPBytes			0	1	1	0	1	1	TargetIP[7:0]								2	TargetIP[15:8]								3	TargetIP[23:16]								4	TargetIP[31:24]								5	TargetIP[39:32]								6	TargetIP[47:40]								7	TargetIP[55:48]								8	TargetIP[63:56]							
	7	6	5	4	3	2	1	0																																																																																					
0	IPBytes			0	1	1	0	1																																																																																					
1	TargetIP[7:0]																																																																																												
2	TargetIP[15:8]																																																																																												
3	TargetIP[23:16]																																																																																												
4	TargetIP[31:24]																																																																																												
5	TargetIP[39:32]																																																																																												
6	TargetIP[47:40]																																																																																												
7	TargetIP[55:48]																																																																																												
8	TargetIP[63:56]																																																																																												
Dependencies	PacketEn	Generation Scenario	Indirect branch (including un-compressed RET), far branch, interrupt, exception, INIT, SIPI, VM exit, VM entry, TSX abort, EENTER, EEXIT, ERESUME, AEX ¹ .																																																																																										
Description	Provides the target for some control flow transfers																																																																																												
Application	<p>Anytime a TIP is encountered, it indicates that control was transferred to the IP provided in the payload.</p> <p>The source of this control flow change, and hence the IP or instruction to which it binds, depends on the packets that precede the TIP. If a TIP is encountered and all preceding packets have already been bound, then the TIP will apply to the upcoming indirect branch, far branch, or VMRESUME. However, if there was a preceding FUP that remains unbound, it will bind to the TIP. Here, the TIP provides the target of an asynchronous event or TSX abort that occurred at the IP given in the FUP payload. Note that there may be other packets, in addition to the FUP, which will bind to the TIP packet. See the packet application descriptions for other packets for details.</p>																																																																																												

NOTES:

1. EENTER, EEXIT, ERESUME, AEX would be possible only for a debug enclave.

IP Compression

The IP payload in a TIP, FUP, TIP.PGE, or TIP.PGD packet can vary in size, based on the mode of execution, and the use of IP compression. IP compression is an optional compression technique the processor may choose to employ to reduce bandwidth. With IP compression, the IP to be represented in the payload is compared with the last IP sent out, via any of FUP, TIP, TIP.PGE, or TIP.PGD. If that previous IP had the same upper (most significant) address bytes, those matching bytes may be suppressed in the current packet. The processor maintains an internal state of the "Last IP" that was encoded in trace packets, thus the decoder will need to keep track of the "Last IP" state in

software, to match fidelity with packets generated by hardware. “Last IP” is initialized to zero, hence if the first IP in the trace may be compressed if the upper bytes are zeroes.

The “IPBytes” field of the IP packets (FUP, TIP, TIP.PGE, TIP.PGD) serves to indicate how many bytes of payload are provided, and how the decoder should fill in any suppressed bytes. The algorithm for reconstructing the IP for a TIP/FUP packet is shown in the table below.

Table 33-18. FUP/TIP IP Reconstruction

IPBytes	Uncompressed IP Value							
	63:56	55:48	47:40	39:32	31:24	23:16	15:8	7:0
000b	None, IP is out of context							
001b	Last IP[63:16]						IP Payload[15:0]	
010b	Last IP[63:32]				IP Payload[31:0]			
011b	IP Payload[47] extended		IP Payload[47:0]					
100b	Last IP [63:48]		IP Payload[47:0]					
101b	Reserved							
110b	IP Payload[63:0]							
111b	Reserved							

The processor-internal Last IP state is guaranteed to be reset to zero when a PSB is sent out. This means that the IP that follows the PSB with either be un-compressed (011b or 110b, see Table 33-18), or compressed against zero.

At times, “IPbytes” will have a value of 0. As shown above, this does not mean that the IP payload matches the full address of the last IP, but rather that the IP for this packet was suppressed. This is used for cases where the IP that applies to the packet is out of context. An example is the TIP.PGD sent on a SYSCALL, when tracing only USR code. In that case, no TargetIP will be included in the packet, since that would expose an instruction point at CPL = 0. When the IP payload is suppressed in this manner, Last IP is not cleared, and instead refers to the last IP packet with a non-zero IPBytes field.

On processors that support a maximum linear address size of 32 bits, IP payloads may never exceed 32 bits (IPBytes <= 010b).

Indirect Transfer Compression for Returns (RET)

In addition to IP compression, TIP packets for near return (RET) instructions can also be compressed. If the RET target matches the next IP of the corresponding CALL, then the TIP packet is unneeded, since the decoder can deduce the target IP by maintaining a CALL/RET stack of its own.

When a RET is compressed, a Taken indication is added to the TNT buffer. Because the RET generates no TIP packet, it also does not update the internal Last IP value, and thus the decoder should treat it the same way. If the RET is not compressed, it will generate a TIP packet (just like when RET compression is disabled, via IA32_RTIT_CTL.DisRETC).

A CALL/RET stack can be maintained by the decoder by doing the following:

1. Allocate space to store 64 RET targets.
2. For near CALLs, push the Next IP onto the stack. Once the stack is full, new CALLs will force the oldest entry off the end of the stack, such that only the youngest 64 entries are stored. Note that this excludes zero-length CALLs, which are direct near CALLs with displacement zero (to the next IP). These CALLs typically don't have matching RETs.
3. For near RETs, pop the top (youngest) entry off the stack. This will be the expected target of the RET.

In cases where a RET is compressed, the RET target is guaranteed to match the expected target from 3) above. If the target is not compressed, a TIP packet will be generated with the RET target, which may differ from the expected target in some cases.

The hardware ensures that packets read by the decoder will always have seen the CALL that corresponds to any compressed RET. The processor will never compress a RET across a PSB, a buffer overflow, or scenario where PacketEn=0. This means that a RET whose corresponding CALL executed while PacketEn=0, or before the last PSB, etc., will not be compressed.

If the CALL/RET stack is manipulated or corrupted by software, and thereby causes a RET to transfer control to a target that is inconsistent with the CALL/RET stack, then the RET will not be compressed, and will produce a TIP packet. This can happen, for example, if software executes a PUSH instruction to push a target onto the stack, and a later RET uses this target.

For processors that employ deferred TIPs (Section 33.4.2.3), an uncompressed RET will not be deferred, and hence will force out any accumulated TNTs or TIPs. This serves to avoid ambiguity, and make clear to the decoder whether the near RET was compressed, and hence a bit in the in-progress TNT should be consumed, or uncompressed, in which case there will be no in-progress TNT and thus a TIP should be consumed.

Note that in the unlikely case that a RET executes in a different execution mode than the associated CALL, the decoder will need to model the same behavior with its CALL stack. For instance, if a CALL executes in 64-bit mode, a 64-bit IP value will be pushed onto the software stack. If the corresponding RET executes in 32-bit mode, then only the lower 32 target bits will be popped off of the stack, which may mean that the RET does not go to the CALL's Next IP. This is architecturally correct behavior, and this RET could be compressed, thus the decoder should match this behavior.

33.4.2.3 Deferred TIPs

The processor may opt to defer sending out the TNT when TIPs are generated. Thus, rather than sending a partial TNT followed by a TIP, both packets will be deferred while the TNT accumulates more Jcc/RET results. Any number of TIP packets may be accumulated this way, such that only once the TNT is filled, or once another packet (e.g., FUP) is generated, the TNT will be sent, followed by all the deferred TIP packets, and finally terminated by the other packet(s) that forced out the TNT and TIP packets. Generation of many other packets (see list below) will force out the TNT and any accumulated TIP packets. This is an optional optimization in hardware to reduce the bandwidth consumption, and hence the performance impact, incurred by tracing.

Table 33-19. TNT Examples with Deferred TIPs

Code Flow	Packets, Non-Deferred TIPS	Packets, Deferred TIPS
0x1000 cmp %rcx, 0 0x1004 jnz Foo // not-taken 0x1008 jmp %rdx	TNT(0b0), TIP(0x1308)	
0x1308 cmp %rcx, 1 0x130c jnz Bar // not-taken 0x1310 cmp %rcx, 2 0x1314 jnz Baz // taken 0x1500 cmp %eax, 7 0x1504 jg Exit // not-taken 0x1508 jmp %r15	TNT(0b010), TIP(0x1100)	
0x1100 cmp %rbx, 1 0x1104 jg Start // not-taken 0x1108 add %rcx, %eax 0x110c ... // an asynchronous interrupt arrives INThandler: 0xcc00 pop %rdx	TNT(0b0), FUP(0x110c), TIP(0xcc00)	TNT(0b00100), TIP(0x1308), TIP(0x1100), FUP(0x110c), TIP(0xcc00)

33.4.2.4 Packet Generation Enable (TIP.PGE) Packet

Table 33-20. TIP.PGE Packet Definition

Name	Target IP - Packet Generation Enable (TIP.PGE) Packet								
Packet Format		7	6	5	4	3	2	1	0
	0	IPBytes			1	0	0	0	1
	1	TargetIP[7:0]							
	2	TargetIP[15:8]							
	3	TargetIP[23:16]							
	4	TargetIP[31:24]							
	5	TargetIP[39:32]							
	6	TargetIP[47:40]							
	7	TargetIP[55:48]							
	8	TargetIP[63:56]							
Dependencies	PacketEn transitions to 1			Generation Scenario	Any branch instruction, control flow transfer, or MOV CR3 that sets PacketEn, a WRMSR that enables packet generation and sets PacketEn				
Description	<p>Indicates that PacketEn has transitioned to 1. It provides the IP at which the tracing begins. This can occur due to any of the enables that comprise PacketEn transitioning from 0 to 1, as long as all the others are asserted. Examples:</p> <ul style="list-style-type: none"> ▪ TriggerEn: This is set on software write to set IA32_RTIT_CTL.TraceEn as long as the Stopped and Error bits in IA32_RTIT_STATUS are clear. The IP payload will be the Next IP of the WRMSR. ▪ FilterEn: This is set when software jumps into the tracing region. This region is defined by enabling IP filtering in IA32_RTIT_CTL.ADDRn_CFG, and defining the range in IA32_RTIT_ADDRn_[AB], see. Section 33.2.5.3. The IP payload will be the target of the branch. ▪ ContextEn: This is set on a CPL change, a CR3 write or any other means of changing ContextEn. The IP payload will be the Next IP of the instruction that changes context if it is not a branch, otherwise it will be the target of the branch. 								
Application	TIP.PGE packets bind to the instruction at the IP given in the payload.								

33.4.2.5 Packet Generation Disable (TIP.PGD) Packet

Table 33-21. TIP.PGD Packet Definition

Name	Target IP - Packet Generation Disable (TIP.PGD) Packet																																																																																												
Packet Format	<table border="1"> <thead> <tr> <th></th> <th>7</th> <th>6</th> <th>5</th> <th>4</th> <th>3</th> <th>2</th> <th>1</th> <th>0</th> </tr> </thead> <tbody> <tr> <td>0</td> <td colspan="3">IPBytes</td> <td>0</td> <td>0</td> <td>0</td> <td>0</td> <td>1</td> </tr> <tr> <td>1</td> <td colspan="8">TargetIP[7:0]</td> </tr> <tr> <td>2</td> <td colspan="8">TargetIP[15:8]</td> </tr> <tr> <td>3</td> <td colspan="8">TargetIP[23:16]</td> </tr> <tr> <td>4</td> <td colspan="8">TargetIP[31:24]</td> </tr> <tr> <td>5</td> <td colspan="8">TargetIP[39:32]</td> </tr> <tr> <td>6</td> <td colspan="8">TargetIP[47:40]</td> </tr> <tr> <td>7</td> <td colspan="8">TargetIP[55:48]</td> </tr> <tr> <td>8</td> <td colspan="8">TargetIP[63:56]</td> </tr> </tbody> </table>				7	6	5	4	3	2	1	0	0	IPBytes			0	0	0	0	1	1	TargetIP[7:0]								2	TargetIP[15:8]								3	TargetIP[23:16]								4	TargetIP[31:24]								5	TargetIP[39:32]								6	TargetIP[47:40]								7	TargetIP[55:48]								8	TargetIP[63:56]							
	7	6	5	4	3	2	1	0																																																																																					
0	IPBytes			0	0	0	0	1																																																																																					
1	TargetIP[7:0]																																																																																												
2	TargetIP[15:8]																																																																																												
3	TargetIP[23:16]																																																																																												
4	TargetIP[31:24]																																																																																												
5	TargetIP[39:32]																																																																																												
6	TargetIP[47:40]																																																																																												
7	TargetIP[55:48]																																																																																												
8	TargetIP[63:56]																																																																																												
Dependencies	PacketEn transitions to 0	Generation Scenario	Any branch instruction, control flow transfer, or MOV CR3 that clears PacketEn, a WRMSR that disables packet generation and clears PacketEn																																																																																										
Description	<p>Indicates that PacketEn has transitioned to 0. It will include the IP at which the tracing ends, unless ContextEn = 0 or TraceEn=0 at the conclusion of the instruction or event that cleared PacketEn.</p> <p>PacketEn can be cleared due to any of the enables that comprise PacketEn transitioning from 1 to 0. Examples:</p> <ul style="list-style-type: none"> ▪ TriggerEn: This is cleared on software write to clear IA32_RTIT_CTL.TraceEn, or when IA32_RTIT_STATUS.Stopped is set, or on operational error. The IP payload will be suppressed in this case, and the "IPBytes" field will have the value 0. ▪ FilterEn: This is cleared when software jumps out of the tracing region. This region is defined by enabling IP filtering in IA32_RTIT_CTL.ADDRn_CFG, and defining the range in IA32_RTIT_ADDRn_[AB], see. Section 33.2.5.3. The IP payload will depend on the type of the branch. For conditional branches, the payload is suppressed (IPBytes = 0), and in this case the destination can be inferred from the disassembly. For any other type of branch, the IP payload will be the target of the branch. ▪ ContextEn: This can happen on a CPL change, a CR3 write or any other means of changing ContextEn. See Section 33.2.5.3 for details. In this case, when ContextEn is cleared, there will be no IP payload. The "IPBytes" field will have value 0. <p>Note that, in cases where a branch that would normally produce a TIP packet (i.e., far transfer, indirect branch, interrupt, etc) or TNT update (conditional branch or compressed RT) causes PacketEn to transition from 1 to 0, the TIP or TNT bit will be replaced with TIP.PGD. The payload of the TIP.PGD will be the target of the branch, unless the result of the instruction causes TraceEn or ContextEn to be cleared (ie, SYSCALL when IA32_RTIT_CTL.OS=0, In the case where a conditional branch clears FilterEn and hence PacketEn, there will be no TNT bit for this branch, replaced instead by the TIP.PGD.</p>																																																																																												
Application	<p>TIP.PGD can be produced by any branch instructions, as well as some non-branch instructions, that clear PacketEn. When produced by a branch, it replaces any TIP or TNT update that the branch would normally produce. In cases where there is an unbound FUP preceding the TIP.PGD, then the TIP.PGD is part of compound operation (i.e., asynchronous event or TSX abort) which cleared PacketEn. For most such cases, the TIP.PGD is simply replacing a TIP, and should be treated the same way. The TIP.PGD may or may not have an IP payload, depending on whether the operation cleared ContextEn.</p> <p>If there is not an associated FUP, the binding will depend on whether there is an IP payload. If there is an IP payload, then the TIP.PGD should be applied to either the next direct branch whose target matches the TIP.PGD payload, or the next branch that would normally generate a TIP or TNT packet. If there is no IP payload, then the TIP.PGD should apply to the next branch or MOV CR3 instruction.</p>																																																																																												

33.4.2.6 Flow Update (FUP) Packet

Table 33-22. FUP Packet Definition

Name	Flow Update (FUP) Packet																																																																																													
Packet Format	<table border="1"> <thead> <tr> <th></th> <th>7</th> <th>6</th> <th>5</th> <th>4</th> <th>3</th> <th>2</th> <th>1</th> <th>0</th> </tr> </thead> <tbody> <tr> <td>0</td> <td colspan="3">IPBytes</td> <td>1</td> <td>1</td> <td>1</td> <td>0</td> <td>1</td> </tr> <tr> <td>1</td> <td colspan="8">IP[7:0]</td> </tr> <tr> <td>2</td> <td colspan="8">IP[15:8]</td> </tr> <tr> <td>3</td> <td colspan="8">IP[23:16]</td> </tr> <tr> <td>4</td> <td colspan="8">IP[31:24]</td> </tr> <tr> <td>5</td> <td colspan="8">IP[39:32]</td> </tr> <tr> <td>6</td> <td colspan="8">IP[47:40]</td> </tr> <tr> <td>7</td> <td colspan="8">IP[55:48]</td> </tr> <tr> <td>8</td> <td colspan="8">IP[63:56]</td> </tr> </tbody> </table>					7	6	5	4	3	2	1	0	0	IPBytes			1	1	1	0	1	1	IP[7:0]								2	IP[15:8]								3	IP[23:16]								4	IP[31:24]								5	IP[39:32]								6	IP[47:40]								7	IP[55:48]								8	IP[63:56]							
	7	6	5	4	3	2	1	0																																																																																						
0	IPBytes			1	1	1	0	1																																																																																						
1	IP[7:0]																																																																																													
2	IP[15:8]																																																																																													
3	IP[23:16]																																																																																													
4	IP[31:24]																																																																																													
5	IP[39:32]																																																																																													
6	IP[47:40]																																																																																													
7	IP[55:48]																																																																																													
8	IP[63:56]																																																																																													
Dependencies	TriggerEn && ContextEn. (Typically depends on BranchEn and FilterEn as well, see Section 33.2.5, Section 33.4.2.21, and Section 33.4.2.22 for details.)	Generation Scenario	Asynchronous Events (interrupts, exceptions, INIT, SIPI, SMI, VM exit, #MC), PSB+, XBEGIN, XEND, XABORT, XACQUIRE, XRELEASE, EENTER, EEXIT, ERESUME, EEE, AEX, ¹ INTO, INT1, INT3, INT <i>n</i> , a WRMSR that disables packet generation.																																																																																											
Description	Provides the source address for asynchronous events, and some other instructions. Is never sent alone, always sent with an associated TIP or MODE packet, and potentially others.																																																																																													
Application	FUP packets provide the IP to which they bind. However, they are never standalone, but are coupled with other packets. In TSX cases, the FUP is immediately preceded by a MODE.TSX, which binds to the same IP. A TIP will follow only in the case of TSX aborts, see Section 33.4.2.8 for details. Otherwise, FUPs are part of compound packet events (see Section 33.4.1). In these compound cases, the FUP provides the source IP for an instruction or event, while a following TIP (or TIP.PGD) packet will provide the destination IP. Other packets may be included in the compound event between the FUP and TIP.																																																																																													

NOTES:

1. EENTER, EEXIT, ERESUME, EEE, AEX apply only if Intel Software Guard Extensions is supported.

FUP IP Payload

Flow Update Packet gives the source address of an instruction when it is needed. In general, branch instructions do not need a FUP, because the source address is clear from the disassembly. For asynchronous events, however, the source address cannot be inferred from the source, and hence a FUP will be sent. Table 33-23 illustrates cases where FUPs are sent, and which IP can be expected in those cases.

Table 33-23. FUP Cases and IP Payload

Event	Flow Update IP	Comment
External Interrupt, NMI/SMI, Traps, Machine Check (trap-like), INIT/SIPI	Address of next instruction (Next IP) that would have been executed	Functionally, this matches the LBR FROM field value and also the EIP value which is saved onto the stack.
Exceptions/Faults, Machine check (fault-like)	Address of the instruction which took the exception/fault (Current IP)	This matches the similar functionality of LBR FROM field value and also the EIP value which is saved onto the stack.
Software Interrupt	Address of the software interrupt instruction (Current IP)	This matches the similar functionality of LBR FROM field value, but does not match the EIP value which is saved onto the stack (Next Linear Instruction Pointer - NLIP).
EENTER, EEXIT, ERESUME, Enclave Exiting Event (EEE), AEX ¹	Current IP of the instruction	This matches the LBR FROM field value and also the EIP value which is saved onto the stack.
XACQUIRE	Address of the X* instruction	
XRELEASE, XBEGIN, XEND, XABORT, other transactional abort	Current IP	
#SMI	IP that is saved into SMRAM	
WRMSR that clears TraceEn, PSB+	Current IP	

NOTES:

1. Information on EENTER, EEXIT, ERESUME, EEE, Asynchronous Enclave eXit (AEX) can be found in the Intel® 64 and IA-32 Architectures Software Developer's Manual, Volume 3D.

On a canonical fault due to sequentially fetching an instruction in non-canonical space (as opposed to jumping to non-canonical space), the IP of the fault (and thus the payload of the FUP) will be a non-canonical address. This is consistent with what is pushed on the stack for such faulting cases.

If there are post-commit task switch faults, the IP value of the FUP will be the original IP when the task switch started. This is the same value as would be seen in the LBR_FROM field. But it is a different value as is saved on the stack or VMCS.

33.4.2.7 Paging Information (PIP) Packet

Table 33-24. PIP Packet Definition

Name	Paging Information (PIP) Packet								
Packet Format		7	6	5	4	3	2	1	0
	0	0	0	0	0	0	0	1	0
	1	0	1	0	0	0	0	1	1
	2	CR3[11:5] or 0							RSVD/NR
	3	CR3[19:12]							
	4	CR3[27:20]							
	5	CR3[35:28]							
	6	CR3[43:36]							
	7	CR3[51:44]							
Dependencies	TriggerEn && ContextEn && IA32_RTIT_CTL.OS			Generation Scenario	MOV CR3, Task switch, INIT, SIPI, PSB+, VM exit, VM entry				
Description	<p>The CR3 payload shown includes only the address portion of the CR3 value. For PAE paging, CR3[11:5] are thus included. For other paging modes (32-bit and 4-level paging¹), these bits are 0.</p> <p>This packet holds the CR3 address value. It will be generated on operations that modify CR3:</p> <ul style="list-style-type: none"> ▪ MOV CR3 operation ▪ Task Switch ▪ INIT and SIPI ▪ VM exit, if “conceal VMX from PT” VM-exit control is 0 (see Section 33.5.1) ▪ VM entry, if “conceal VMX from PT” VM-entry control is 0 <p>PIPs are not generated, despite changes to CR3, on SMI and RSM. This is due to the special behavior on these operations, see Section 33.2.9.3 for details. Note that, for some cases of task switch where CR3 is not modified, no PIP will be produced.</p> <p>The purpose of the PIP is to indicate to the decoder which application is running, so that it can apply the proper binaries to the linear addresses that are being traced.</p> <p>The PIP packet contains the new CR3 value when CR3 is written.</p> <p>PIPs generated by VM entries set the NR bit. PIPs generated in VMX non-root operation set the NR bit if the “conceal VMX from PT” VM-execution control is 0 (see Section 33.5.1). All other PIPs clear the NR bit.</p>								
Application	<p>The purpose of the PIP packet is to help the decoder uniquely identify what software is running at any given time. When a PIP is encountered, a decoder should do the following:</p> <ol style="list-style-type: none"> 1) If there was a prior unbound FUP (that is, a FUP not preceded by a packet such as MODE.TSX that consumes it, and it hence pairs with a TIP that has not yet been seen), then this PIP is part of a compound packet event (Section 33.4.1). Find the ending TIP and apply the new CR3/NR values to the TIP payload IP. 2) Otherwise, look for the next MOV CR3, far branch, or VMRESUME/VMLAUNCH in the disassembly, and apply the new CR3 to the next (or target) IP. <p>For examples of the packets generated by these flows, see Section 33.7.</p>								

NOTES:

1. Earlier versions of this manual used the term “IA-32e paging” to identify 4-level paging.

33.4.2.8 MODE Packets

MODE packets keep the decoder informed of various processor modes about which it needs to know in order to properly manage the packet output, or to properly disassemble the associated binaries. MODE packets include a header and a mode byte, as shown below.

Table 33-25. General Form of MODE Packets

	7	6	5	4	3	2	1	0
0	1	0	0	1	1	0	0	1
1	Leaf ID			Mode				

The MODE Leaf ID indicates which set of mode bits are held in the lower bits.

MODE.Exec Packet

Table 33-26. MODE.Exec Packet Definition

Name	MODE.Exec Packet																													
Packet Format	<table border="1"> <tr> <td></td> <td>7</td> <td>6</td> <td>5</td> <td>4</td> <td>3</td> <td>2</td> <td>1</td> <td>0</td> </tr> <tr> <td>0</td> <td>1</td> <td>0</td> <td>0</td> <td>1</td> <td>1</td> <td>0</td> <td>0</td> <td>1</td> </tr> <tr> <td>1</td> <td>0</td> <td>0</td> <td>0</td> <td colspan="2">Reserved</td> <td>IF</td> <td>CS.D</td> <td>(CS.L & LMA)</td> </tr> </table> <p>MODE Leaf ID is '000.</p>				7	6	5	4	3	2	1	0	0	1	0	0	1	1	0	0	1	1	0	0	0	Reserved		IF	CS.D	(CS.L & LMA)
	7	6	5	4	3	2	1	0																						
0	1	0	0	1	1	0	0	1																						
1	0	0	0	Reserved		IF	CS.D	(CS.L & LMA)																						
Dependencies	TriggerEn && ContextEn && FilterEn	Generation Scenario	<p>Any operation that changes the CS.L, CS.D, or EFER.LMA, if IA32_RTIT_CTL.BranchEn=1.</p> <p>Any operation that changes RFLAGS.IF, if IA32_RTIT_CTL.EventEn=1.</p> <p>Any TIP.PGE scenario, such that any of the mode bits tracked may have changed since the last MODE.Exec.</p>																											
Description	<p>Indicates whether software is in 16, 32, or 64-bit mode, by providing the CS.D and (CS.L & IA32_EFER.LMA) values. Essential for the decoder to properly disassemble the associated binary. Further, if CPUID.0x14.0.EBX[6]=1 ("Event Trace Support"), it indicates when interrupts are masked by providing the RFLAGS.IF value.</p> <p>MODE.Exec is sent at the time of a mode change, if dependencies are met at the time, otherwise it is sent when tracing resumes. In the former case, the MODE.Exec packet is generated along with other packets that result from the operation that changes the mode, and is guaranteed to be followed by a TIP or TIP.PGE for branch operations, or a FUP for non-branch operations (CLI, STI, or POPF if EventEn=1). In cases where the mode changes while filtering dependencies are not met, the processor ensures that the decoder doesn't lose track of the mode by sending any needed MODE.Exec once tracing resumes (preceding the TIP.PGE, if BranchEn=1). The processor may opt to suppress the MODE.Exec when tracing resumes if the mode matches that of the last MODE.Exec packet.</p> <p>MODE.Exec packets are generated on CS.L, CS.D, or EFER.LMA changes only if control flow tracing is enabled (BranchEn=1). This is essential for the decoder to properly disassemble the associated binary.</p> <table border="1"> <tr> <td>CS.D</td> <td>(CS.L & IA32_EFER.LMA)</td> <td>Addressing Mode</td> </tr> <tr> <td>1</td> <td>1</td> <td>N/A</td> </tr> <tr> <td>0</td> <td>1</td> <td>64-bit mode</td> </tr> <tr> <td>1</td> <td>0</td> <td>32-bit mode</td> </tr> <tr> <td>0</td> <td>0</td> <td>16-bit mode</td> </tr> </table> <p>MODE.Exec packets are generated on interrupt flag (RFLAGS.IF) changes only if event tracing is enabled (EventEn=1).</p>			CS.D	(CS.L & IA32_EFER.LMA)	Addressing Mode	1	1	N/A	0	1	64-bit mode	1	0	32-bit mode	0	0	16-bit mode												
CS.D	(CS.L & IA32_EFER.LMA)	Addressing Mode																												
1	1	N/A																												
0	1	64-bit mode																												
1	0	32-bit mode																												
0	0	16-bit mode																												
Application	<p>MODE.Exec always precedes an IP packet (TIP, TIP.PGE, or FUP). The mode change applies to the IP address in the payload of the IP packet. When MODE.Exec is followed by a FUP, it is a stand-alone FUP and should be consumed by the MODE.Exec.</p>																													

MODE.TSX Packet

Table 33-27. MODE.TSX Packet Definition

Name	MODE.TSX Packet																																		
Packet Format	<table border="1"> <tr> <td></td> <td>7</td> <td>6</td> <td>5</td> <td>4</td> <td>3</td> <td>2</td> <td>1</td> <td>0</td> </tr> <tr> <td>0</td> <td>1</td> <td>0</td> <td>0</td> <td>1</td> <td>1</td> <td>0</td> <td>0</td> <td>1</td> </tr> <tr> <td>1</td> <td>0</td> <td>0</td> <td>1</td> <td>0</td> <td>0</td> <td>0</td> <td>TXAbort</td> <td>InTX</td> </tr> </table>									7	6	5	4	3	2	1	0	0	1	0	0	1	1	0	0	1	1	0	0	1	0	0	0	TXAbort	InTX
		7	6	5	4	3	2	1	0																										
	0	1	0	0	1	1	0	0	1																										
1	0	0	1	0	0	0	TXAbort	InTX																											
Dependencies	TriggerEn && ContextEn	Generation Scenario	XBEGIN, XEND, XABORT, XACQUIRE, XRELEASE, if InTX changes, Asynchronous TSX Abort, PSB+																																
Description	Indicates when a TSX transaction (either HLE or RTM) begins, commits, or aborts. Instructions executed transactionally will be “rolled back” if the transaction is aborted.																																		
	<table border="1"> <thead> <tr> <th>TXAbort</th> <th>InTX</th> <th>Implication</th> </tr> </thead> <tbody> <tr> <td>1</td> <td>1</td> <td>N/A</td> </tr> <tr> <td>0</td> <td>1</td> <td>Transaction begins, or executing transactionally</td> </tr> <tr> <td>1</td> <td>0</td> <td>Transaction aborted</td> </tr> <tr> <td>0</td> <td>0</td> <td>Transaction committed, or not executing transactionally</td> </tr> </tbody> </table>								TXAbort	InTX	Implication	1	1	N/A	0	1	Transaction begins, or executing transactionally	1	0	Transaction aborted	0	0	Transaction committed, or not executing transactionally												
	TXAbort	InTX	Implication																																
	1	1	N/A																																
	0	1	Transaction begins, or executing transactionally																																
	1	0	Transaction aborted																																
0	0	Transaction committed, or not executing transactionally																																	
Application	<p>If PacketEn=1, MODE.TSX always immediately precedes a FUP. If the TXAbort bit is zero, then the mode change applies to the IP address in the payload of the FUP. If TXAbort=1, then the FUP will be followed by a TIP, and the mode change will apply to the IP address in the payload of the TIP.</p> <p>MODE.TSX packets may be generated when PacketEn=0, due to FilterEn=0. In this case, only the last MODE.TSX generated before TIP.PGE need be applied.</p>																																		

33.4.2.9 TraceStop Packet

Table 33-28. TraceStop Packet Definition

Name	TraceStop Packet																													
Packet Format	<table border="1"> <tr> <td></td> <td>7</td> <td>6</td> <td>5</td> <td>4</td> <td>3</td> <td>2</td> <td>1</td> <td>0</td> </tr> <tr> <td>0</td> <td>0</td> <td>0</td> <td>0</td> <td>0</td> <td>0</td> <td>0</td> <td>1</td> <td>0</td> </tr> <tr> <td>1</td> <td>1</td> <td>0</td> <td>0</td> <td>0</td> <td>0</td> <td>0</td> <td>1</td> <td>1</td> </tr> </table>				7	6	5	4	3	2	1	0	0	0	0	0	0	0	0	1	0	1	1	0	0	0	0	0	1	1
	7	6	5	4	3	2	1	0																						
0	0	0	0	0	0	0	1	0																						
1	1	0	0	0	0	0	1	1																						
Dependencies	TriggerEn && ContextEn	Generation Scenario	Taken branch with target in TraceStop IP region, MOV CR3 in TraceStop IP region, or WRMSR that sets TraceEn in TraceStop IP region.																											
Description	<p>Indicates when software has entered a user-configured TraceStop region. When the IP matches a TraceStop range while ContextEn and TriggerEn are set, a TraceStop action occurs. This disables tracing by setting IA32_RTIT_STATUS.Stopped, thereby clearing TriggerEn, and causes a TraceStop packet to be generated.</p> <p>The TraceStop action also forces FilterEn to 0. Note that TraceStop may not force a flush of internally buffered packets, and thus trace packet generation should still be manually disabled by clearing IA32_RTIT_CTL.TraceEn before examining output. See Section 33.2.5.3 for more details.</p>																													
Application	<p>If TraceStop follows a TIP.PGD (before the next TIP.PGE), then it was triggered either by the instruction that cleared PacketEn, or it was triggered by some later instruction that executed while FilterEn=0. In either case, the TraceStop can be applied at the IP of the TIP.PGD (if any).</p> <p>If TraceStop follows a TIP.PGE (before the next TIP.PGD), it should be applied at the last known IP.</p>																													

33.4.2.10 Core:Bus Ratio (CBR) Packet

Table 33-29. CBR Packet Definition

Name	Core:Bus Ratio (CBR) Packet																																															
Packet Format	<table border="1"> <tr> <td></td> <td>7</td> <td>6</td> <td>5</td> <td>4</td> <td>3</td> <td>2</td> <td>1</td> <td>0</td> </tr> <tr> <td>0</td> <td>0</td> <td>0</td> <td>0</td> <td>0</td> <td>0</td> <td>0</td> <td>1</td> <td>0</td> </tr> <tr> <td>1</td> <td>0</td> <td>0</td> <td>0</td> <td>0</td> <td>0</td> <td>0</td> <td>1</td> <td>1</td> </tr> <tr> <td>2</td> <td colspan="8">Core:Bus Ratio</td> </tr> <tr> <td>3</td> <td colspan="8">Reserved</td> </tr> </table>				7	6	5	4	3	2	1	0	0	0	0	0	0	0	0	1	0	1	0	0	0	0	0	0	1	1	2	Core:Bus Ratio								3	Reserved							
	7	6	5	4	3	2	1	0																																								
0	0	0	0	0	0	0	1	0																																								
1	0	0	0	0	0	0	1	1																																								
2	Core:Bus Ratio																																															
3	Reserved																																															
Dependencies	TriggerEn	Generation Scenario	After any frequency change, on C-state wake up, PSB+, and after enabling trace packet generation.																																													
Description	Indicates the core:bus ratio of the processor core. Useful for correlating wall-clock time and cycle time.																																															
Application	The CBR packet indicates the point in the trace when a frequency transition has occurred. On some implementations, software execution will continue during transitions to a new frequency, while on others software execution ceases during frequency transitions. There is not a precise IP provided, to which to bind the CBR packet.																																															

33.4.2.11 Timestamp Counter (TSC) Packet

Table 33-30. TSC Packet Definition

Name	Timestamp Counter (TSC) Packet																																																																																			
Packet Format	<table border="1"> <thead> <tr> <th></th> <th>7</th> <th>6</th> <th>5</th> <th>4</th> <th>3</th> <th>2</th> <th>1</th> <th>0</th> </tr> </thead> <tbody> <tr> <td>0</td> <td>0</td> <td>0</td> <td>0</td> <td>1</td> <td>1</td> <td>0</td> <td>0</td> <td>1</td> </tr> <tr> <td>1</td> <td colspan="8">SW TSC[7:0]</td> </tr> <tr> <td>2</td> <td colspan="8">SW TSC[15:8]</td> </tr> <tr> <td>3</td> <td colspan="8">SW TSC[23:16]</td> </tr> <tr> <td>4</td> <td colspan="8">SW TSC[31:24]</td> </tr> <tr> <td>5</td> <td colspan="8">SW TSC[39:32]</td> </tr> <tr> <td>6</td> <td colspan="8">SW TSC[47:40]</td> </tr> <tr> <td>7</td> <td colspan="8">SW TSC[55:48]</td> </tr> </tbody> </table>				7	6	5	4	3	2	1	0	0	0	0	0	1	1	0	0	1	1	SW TSC[7:0]								2	SW TSC[15:8]								3	SW TSC[23:16]								4	SW TSC[31:24]								5	SW TSC[39:32]								6	SW TSC[47:40]								7	SW TSC[55:48]							
	7	6	5	4	3	2	1	0																																																																												
0	0	0	0	1	1	0	0	1																																																																												
1	SW TSC[7:0]																																																																																			
2	SW TSC[15:8]																																																																																			
3	SW TSC[23:16]																																																																																			
4	SW TSC[31:24]																																																																																			
5	SW TSC[39:32]																																																																																			
6	SW TSC[47:40]																																																																																			
7	SW TSC[55:48]																																																																																			
Dependencies	IA32_RTIT_CTL.TSCEn && TriggerEn	Generation Scenario	Sent after any event that causes the processor clocks or Intel PT timing packets (such as MTC or CYC) to stop, This may include P-state changes, wake from C-state, or clock modulation. Also on transition of TraceEn from 0 to 1.																																																																																	
Description	When enabled by software, a TSC packet provides the lower 7 bytes of the current TSC value, as returned by the RDTSC instruction. This may be useful for tracking wall-clock time, and synchronizing the packets in the log with other timestamped logs.																																																																																			
Application	TSC packet provides a wall-clock proxy of the event which generated it (packet generation enable, sleep state wake, etc). In all cases, TSC does not precisely indicate the time of any control flow packets; however, all preceding packets represent instructions that executed before the indicated TSC time, and all subsequent packets represent instructions that executed after it. There is not a precise IP to which to bind the TSC packet.																																																																																			

33.4.2.12 Mini Time Counter (MTC) Packet

Table 33-31. MTC Packet Definition

Name	Mini time Counter (MTC) Packet																																		
Packet Format	<table border="1" style="width: 100%; text-align: center;"> <tr> <td style="width: 10%;"></td> <td style="width: 10%;">7</td> <td style="width: 10%;">6</td> <td style="width: 10%;">5</td> <td style="width: 10%;">4</td> <td style="width: 10%;">3</td> <td style="width: 10%;">2</td> <td style="width: 10%;">1</td> <td style="width: 10%;">0</td> </tr> <tr> <td>0</td> <td>0</td> <td>1</td> <td>0</td> <td>1</td> <td>1</td> <td>0</td> <td>0</td> <td>1</td> </tr> <tr> <td>1</td> <td colspan="8">CTC[N+7:N]</td> </tr> </table>									7	6	5	4	3	2	1	0	0	0	1	0	1	1	0	0	1	1	CTC[N+7:N]							
	7	6	5	4	3	2	1	0																											
0	0	1	0	1	1	0	0	1																											
1	CTC[N+7:N]																																		
Dependencies	IA32_RTIT_CTL.MTCEn && TriggerEn	Generation Scenario	Periodic, based on the core crystal clock, or Always Running Timer (ART).																																
Description	<p>When enabled by software, an MTC packet provides a periodic indication of wall-clock time. The 8-bit CTC (Common Timestamp Copy) payload value is set to (ART >> N) & FFH. The frequency of the ART is related to the Maximum Non-Turbo frequency, and the ratio can be determined from CPUID leaf 15H, as described in Section 33.8.3. Software can select the threshold N, which determines the MTC frequency by setting the IA32_RTIT_CTL.MTCFreq field (see Section 33.2.8.2) to a supported value using the lookup enumerated by CPUID (see Section 33.3.1). See Section 33.8.3 for details on how to use the MTC payload to track TSC time.</p> <p>MTC provides 8 bits from the ART, starting with the bit selected by MTCFreq to dictate the frequency of the packet. Whenever that 8-bit range being watched changes, an MTC packet will be sent out with the new value of that 8-bit range. This allows the decoder to keep track of how much wall-clock time has elapsed since the last TSC packet was sent, by keeping track of how many MTC packets were sent and what their value was. The decoder can infer the truncated bits, CTC[N-1:0], are 0 at the time of the MTC packet.</p> <p>There are cases in which MTC packet can be dropped, due to overflow or other micro-architectural conditions. The decoder should be able to recover from such cases by checking the 8-bit payload of the next MTC packet, to determine how many MTC packets were dropped. It is not expected that >256 consecutive MTC packets should ever be dropped.</p>																																		
Application	MTC does not precisely indicate the time of any other packet, nor does it bind to any IP. However, all preceding packets represent instructions or events that executed before the indicated ART time, and all subsequent packets represent instructions that executed after, or at the same time as, the ART time.																																		

33.4.2.13 TSC/MTC Alignment (TMA) Packet

Table 33-32. TMA Packet Definition

Name	TSC/MTC Alignment (TMA) Packet																																																																										
Packet Format	<table border="1"> <thead> <tr> <th></th> <th>7</th> <th>6</th> <th>5</th> <th>4</th> <th>3</th> <th>2</th> <th>1</th> <th>0</th> </tr> </thead> <tbody> <tr> <td>0</td> <td>0</td> <td>0</td> <td>0</td> <td>0</td> <td>0</td> <td>0</td> <td>1</td> <td>0</td> </tr> <tr> <td>1</td> <td>0</td> <td>1</td> <td>1</td> <td>1</td> <td>0</td> <td>0</td> <td>1</td> <td>1</td> </tr> <tr> <td>2</td> <td colspan="8">CTC[7:0]</td> </tr> <tr> <td>3</td> <td colspan="8">CTC[15:8]</td> </tr> <tr> <td>4</td> <td colspan="7">Reserved</td> <td>0</td> </tr> <tr> <td>5</td> <td colspan="8">FastCounter[7:0]</td> </tr> <tr> <td>6</td> <td colspan="7">Reserved</td> <td>FC[8]</td> </tr> </tbody> </table>				7	6	5	4	3	2	1	0	0	0	0	0	0	0	0	1	0	1	0	1	1	1	0	0	1	1	2	CTC[7:0]								3	CTC[15:8]								4	Reserved							0	5	FastCounter[7:0]								6	Reserved							FC[8]
	7	6	5	4	3	2	1	0																																																																			
0	0	0	0	0	0	0	1	0																																																																			
1	0	1	1	1	0	0	1	1																																																																			
2	CTC[7:0]																																																																										
3	CTC[15:8]																																																																										
4	Reserved							0																																																																			
5	FastCounter[7:0]																																																																										
6	Reserved							FC[8]																																																																			
Dependencies	IA32_RTIT_CTL.MTCEn && IA32_RTIT_CTL.TSCEn && TriggerEn	Generation Scenario	Sent with any TSC packet.																																																																								
Description	The TMA packet serves to provide the information needed to allow the decoder to correlate MTC packets with TSC packets. With this packet, when a MTC packet is encountered, the decoder can determine how many timestamp counter ticks have passed since the last TSC or MTC packet. See Section 33.8.3.2 for details on how to make this calculation.																																																																										
Application	TMA is always sent immediately following a TSC packet, and the payload values are consistent with the TSC payload value. Thus the application of TMA matches that of TSC.																																																																										

33.4.2.14 Cycle Count (CYC) Packet

Table 33-33. Cycle Count Packet Definition

Name	Cycle Count (CYC) Packet																																															
Packet Format	<table border="1" style="width: 100%; border-collapse: collapse;"> <thead> <tr> <th style="width: 10%;"></th> <th style="width: 10%;">7</th> <th style="width: 10%;">6</th> <th style="width: 10%;">5</th> <th style="width: 10%;">4</th> <th style="width: 10%;">3</th> <th style="width: 10%;">2</th> <th style="width: 10%;">1</th> <th style="width: 10%;">0</th> </tr> </thead> <tbody> <tr> <td>0</td> <td colspan="5">Cycle Counter[4:0]</td> <td>Exp</td> <td>1</td> <td>1</td> </tr> <tr> <td>1</td> <td colspan="7">Cycle Counter[11:5]</td> <td>Exp</td> </tr> <tr> <td>2</td> <td colspan="7">Cycle Counter[18:12]</td> <td>Exp</td> </tr> <tr> <td>...</td> <td colspan="8">... (if Exp = 1 in the previous byte)</td> </tr> </tbody> </table>				7	6	5	4	3	2	1	0	0	Cycle Counter[4:0]					Exp	1	1	1	Cycle Counter[11:5]							Exp	2	Cycle Counter[18:12]							Exp (if Exp = 1 in the previous byte)							
	7	6	5	4	3	2	1	0																																								
0	Cycle Counter[4:0]					Exp	1	1																																								
1	Cycle Counter[11:5]							Exp																																								
2	Cycle Counter[18:12]							Exp																																								
...	... (if Exp = 1 in the previous byte)																																															
Dependencies	IA32_RTIT_CTL.CYCEn && TriggerEn	Generation Scenario	Can be sent at any time, though a maximum of one CYC packet is sent per core clock cycle. See Section 33.3.6 for CYC-eligible packets.																																													
Description	<p>The Cycle Counter field increments at the same rate as the processor core clock ticks, but with a variable length format (using a trailing EXP bit field) and a range-capped byte length.</p> <p>If the CYC value is less than 32, a 1-byte CYC will be generated, with Exp=0. If the CYC value is between 32 and 4095 inclusive, a 2-byte CYC will be generated, with byte 0 Exp=1 and byte 1 Exp=0. And so on.</p> <p>CYC provides the number of core clocks that have passed since the last CYC packet. CYC can be configured to be sent in every cycle in which an eligible packet is generated, or software can opt to use a threshold to limit the number of CYC packets, at the expense of some precision. These settings are configured using the IA32_RTIT_CTL.CycThresh field (see Section 33.2.8.2). For details on Cycle-Accurate Mode, IPC calculation, etc, see Section 33.3.6.</p> <p>When CycThresh=0, and hence no threshold is in use, then a CYC packet will be generated in any cycle in which any CYC-eligible packet is generated. The CYC packet will precede the other packets generated in the cycle, and provides the precise cycle time of the packets that follow.</p> <p>In addition to these CYC packets generated with other packets, CYC packets can be sent stand-alone. These packets serve simply to update the decoder with the number of cycles passed, and are used to ensure that a wrap of the processor's internal cycle counter doesn't cause cycle information to be lost. These stand-alone CYC packets do not indicate the cycle time of any other packet or operation, and will be followed by another CYC packet before any other CYC-eligible packet is seen.</p> <p>When CycThresh>0, CYC packets are generated only after a minimum number of cycles have passed since the last CYC packet. Once this threshold has passed, the behavior above resumes, where CYC will either be sent in the next cycle that produces other CYC-eligible packets, or could be sent stand-alone.</p> <p>When using CYC thresholds, only the cycle time of the operation (instruction or event) that generates the CYC packet is truly known. Other operations simply have their execution time bounded: they completed at or after the last CYC time, and before the next CYC time.</p>																																															
Application	<p>CYC provides the offset cycle time (since the last CYC packet) for the CYC-eligible packet that follows. If another CYC is encountered before the next CYC-eligible packet, the cycle values should be accumulated and applied to the next CYC-eligible packet.</p> <p>If a CYC packet is generated by a TNT, note that the cycle time provided by the CYC packet applies to the first branch in the TNT packet.</p>																																															

33.4.2.15 VMCS Packet

Table 33-34. VMCS Packet Definition

Name	VMCS Packet																																																																										
Packet Format	<table border="1"> <thead> <tr> <th></th> <th>7</th> <th>6</th> <th>5</th> <th>4</th> <th>3</th> <th>2</th> <th>1</th> <th>0</th> </tr> </thead> <tbody> <tr> <td>0</td> <td>0</td> <td>0</td> <td>0</td> <td>0</td> <td>0</td> <td>0</td> <td>1</td> <td>0</td> </tr> <tr> <td>1</td> <td>1</td> <td>1</td> <td>0</td> <td>0</td> <td>1</td> <td>0</td> <td>0</td> <td>0</td> </tr> <tr> <td>2</td> <td colspan="8">VMCS pointer [19:12]</td> </tr> <tr> <td>3</td> <td colspan="8">VMCS pointer [27:20]</td> </tr> <tr> <td>4</td> <td colspan="8">VMCS pointer [35:28]</td> </tr> <tr> <td>5</td> <td colspan="8">VMCS pointer [43:36]</td> </tr> <tr> <td>6</td> <td colspan="8">VMCS pointer [51:44]</td> </tr> </tbody> </table>				7	6	5	4	3	2	1	0	0	0	0	0	0	0	0	1	0	1	1	1	0	0	1	0	0	0	2	VMCS pointer [19:12]								3	VMCS pointer [27:20]								4	VMCS pointer [35:28]								5	VMCS pointer [43:36]								6	VMCS pointer [51:44]							
	7	6	5	4	3	2	1	0																																																																			
0	0	0	0	0	0	0	1	0																																																																			
1	1	1	0	0	1	0	0	0																																																																			
2	VMCS pointer [19:12]																																																																										
3	VMCS pointer [27:20]																																																																										
4	VMCS pointer [35:28]																																																																										
5	VMCS pointer [43:36]																																																																										
6	VMCS pointer [51:44]																																																																										
Dependencies	TriggerEn && ContextEn; Also in VMX operation.	Generation Scenario	Generated on successful VMPTRLD, and optionally on PSB+, SMM VM exits, and VM entries that return from SMM (see Section 33-53).																																																																								
Description	<p>The VMCS packet provides a VMCS pointer for a decoder to determine the transition of code contexts:</p> <ul style="list-style-type: none"> On a successful VMPTRLD (i.e., a VMPTRLD that doesn't fault, fail, or VM exit), the VMCS packet contains the logical processor's VMCS pointer established by VMPTRLD (for subsequent execution of a VM guest context). An SMM VM exit loads the logical processor's VMCS pointer with the SMM-transfer VMCS pointer. If the "conceal VMX from PT" VM-exit control is 0 (see Section 33.5.1), a VMCS packet provides this pointer. See Section 33.6 on tracing inside and outside STM. A VM entry that returns from SMM loads the logical processor's VMCS pointer from a field in the SMM-transfer VMCS. If the "conceal VMX from PT" VM-entry control is 0, a VMCS packet provides this pointer. Whether the VM entry is to VMX root operation or VMX non-root operation is indicated by the PIP.NR bit. <p>A VMCS packet generated before a VMCS pointer has been loaded, or after the VMCS pointer has been cleared will set all 64 bits in the VMCS pointer field.</p> <p>VMCS packets will not be seen on processors with IA32_VMX_MISC[bit 14]=0, as these processors do not allow TraceEn to be set in VMX operation.</p>																																																																										
Application	<p>The purpose of the VMCS packet is to help the decoder uniquely identify changes in the executing software context in situations that CR3 may not be unique.</p> <p>When a VMCS packet is encountered, a decoder should do the following:</p> <ul style="list-style-type: none"> If there was a prior unbound FUP (that is, a FUP not preceded by a packet such as MODE.TSX that consumes it, and it hence pairs with a TIP that has not yet been seen), then this VMCS is part of a compound packet event (Section 33.4.1). Find the ending TIP and apply the new VMCS base pointer value to the TIP payload IP. Otherwise, look for the next VMPTRLD, VMRESUME, or VMLAUNCH in the disassembly, and apply the new VMCS base pointer on the next VM entry. <p>For examples of the packets generated by these flows, see Section 33.7.</p>																																																																										

33.4.2.16 Overflow (OVF) Packet

Table 33-35. OVF Packet Definition

Name	Overflow (OVF) Packet																																		
Packet Format	<table border="1"> <thead> <tr> <th></th> <th>7</th> <th>6</th> <th>5</th> <th>4</th> <th>3</th> <th>2</th> <th>1</th> <th>0</th> </tr> </thead> <tbody> <tr> <td>0</td> <td>0</td> <td>0</td> <td>0</td> <td>0</td> <td>0</td> <td>0</td> <td>1</td> <td>0</td> </tr> <tr> <td>1</td> <td>1</td> <td>1</td> <td>1</td> <td>1</td> <td>0</td> <td>0</td> <td>1</td> <td>1</td> </tr> </tbody> </table>									7	6	5	4	3	2	1	0	0	0	0	0	0	0	0	1	0	1	1	1	1	1	0	0	1	1
		7	6	5	4	3	2	1	0																										
	0	0	0	0	0	0	0	1	0																										
	1	1	1	1	1	0	0	1	1																										
Dependencies	TriggerEn	Generation Scenario	On resolution of internal buffer overflow																																
Description	OVF simply indicates to the decoder that an internal buffer overflow occurred, and packets were likely lost. If BranchEN= 1, OVF is followed by a FUP or TIP.PGE which will provide the IP at which packet generation resumes. See Section 33.3.8.																																		
Application	When an OVF packet is encountered, the decoder should skip to the IP given in the subsequent FUP or TIP.PGE. The cycle counter for the CYC packet will be reset at the time the OVF packet is sent. Software should reset its call stack depth on overflow, since no RET compression is allowed across an overflow. Similarly, any IP compression that follows the OVF is guaranteed to use as a reference LastIP the IP payload of an IP packet that preceded the overflow.																																		

33.4.2.17 Packet Stream Boundary (PSB) Packet

Table 33-36. PSB Packet Definition

Name	Packet Stream Boundary (PSB) Packet																																																																																																																																																																
Packet Format	<table border="1"> <thead> <tr> <th></th> <th>7</th> <th>6</th> <th>5</th> <th>4</th> <th>3</th> <th>2</th> <th>1</th> <th>0</th> </tr> </thead> <tbody> <tr><td>0</td><td>0</td><td>0</td><td>0</td><td>0</td><td>0</td><td>0</td><td>1</td><td>0</td></tr> <tr><td>1</td><td>1</td><td>0</td><td>0</td><td>0</td><td>0</td><td>0</td><td>1</td><td>0</td></tr> <tr><td>2</td><td>0</td><td>0</td><td>0</td><td>0</td><td>0</td><td>0</td><td>1</td><td>0</td></tr> <tr><td>3</td><td>1</td><td>0</td><td>0</td><td>0</td><td>0</td><td>0</td><td>1</td><td>0</td></tr> <tr><td>4</td><td>0</td><td>0</td><td>0</td><td>0</td><td>0</td><td>0</td><td>1</td><td>0</td></tr> <tr><td>5</td><td>1</td><td>0</td><td>0</td><td>0</td><td>0</td><td>0</td><td>1</td><td>0</td></tr> <tr><td>6</td><td>0</td><td>0</td><td>0</td><td>0</td><td>0</td><td>0</td><td>1</td><td>0</td></tr> <tr><td>7</td><td>1</td><td>0</td><td>0</td><td>0</td><td>0</td><td>0</td><td>1</td><td>0</td></tr> <tr><td>8</td><td>0</td><td>0</td><td>0</td><td>0</td><td>0</td><td>0</td><td>1</td><td>0</td></tr> <tr><td>9</td><td>1</td><td>0</td><td>0</td><td>0</td><td>0</td><td>0</td><td>1</td><td>0</td></tr> <tr><td>10</td><td>0</td><td>0</td><td>0</td><td>0</td><td>0</td><td>0</td><td>1</td><td>0</td></tr> <tr><td>11</td><td>1</td><td>0</td><td>0</td><td>0</td><td>0</td><td>0</td><td>1</td><td>0</td></tr> <tr><td>12</td><td>0</td><td>0</td><td>0</td><td>0</td><td>0</td><td>0</td><td>1</td><td>0</td></tr> <tr><td>13</td><td>1</td><td>0</td><td>0</td><td>0</td><td>0</td><td>0</td><td>1</td><td>0</td></tr> <tr><td>14</td><td>0</td><td>0</td><td>0</td><td>0</td><td>0</td><td>0</td><td>1</td><td>0</td></tr> <tr><td>15</td><td>1</td><td>0</td><td>0</td><td>0</td><td>0</td><td>0</td><td>1</td><td>0</td></tr> </tbody> </table>									7	6	5	4	3	2	1	0	0	0	0	0	0	0	0	1	0	1	1	0	0	0	0	0	1	0	2	0	0	0	0	0	0	1	0	3	1	0	0	0	0	0	1	0	4	0	0	0	0	0	0	1	0	5	1	0	0	0	0	0	1	0	6	0	0	0	0	0	0	1	0	7	1	0	0	0	0	0	1	0	8	0	0	0	0	0	0	1	0	9	1	0	0	0	0	0	1	0	10	0	0	0	0	0	0	1	0	11	1	0	0	0	0	0	1	0	12	0	0	0	0	0	0	1	0	13	1	0	0	0	0	0	1	0	14	0	0	0	0	0	0	1	0	15	1	0	0	0	0	0	1	0
		7	6	5	4	3	2	1	0																																																																																																																																																								
	0	0	0	0	0	0	0	1	0																																																																																																																																																								
	1	1	0	0	0	0	0	1	0																																																																																																																																																								
	2	0	0	0	0	0	0	1	0																																																																																																																																																								
	3	1	0	0	0	0	0	1	0																																																																																																																																																								
	4	0	0	0	0	0	0	1	0																																																																																																																																																								
	5	1	0	0	0	0	0	1	0																																																																																																																																																								
	6	0	0	0	0	0	0	1	0																																																																																																																																																								
	7	1	0	0	0	0	0	1	0																																																																																																																																																								
	8	0	0	0	0	0	0	1	0																																																																																																																																																								
	9	1	0	0	0	0	0	1	0																																																																																																																																																								
	10	0	0	0	0	0	0	1	0																																																																																																																																																								
	11	1	0	0	0	0	0	1	0																																																																																																																																																								
	12	0	0	0	0	0	0	1	0																																																																																																																																																								
	13	1	0	0	0	0	0	1	0																																																																																																																																																								
	14	0	0	0	0	0	0	1	0																																																																																																																																																								
15	1	0	0	0	0	0	1	0																																																																																																																																																									

Table 33-36. PSB Packet Definition (Contd.)

Dependencies	TriggerEn	Generation Scenario	Periodic, based on the number of output bytes generated while tracing. PSB is sent when IA32_RTIT_STATUS.PacketByteCnt=0, and each time it crosses the software selected threshold after that. May be sent for other micro-architectural conditions as well.
Description	PSB is a unique pattern in the packet output log, and hence serves as a sync point for the decoder. It is a pattern that the decoder can search for in order to get aligned on packet boundaries. This packet is periodic, based on the number of output bytes, as indicated by IA32_RTIT_STATUS.PacketByteCnt. The period is chosen by software, via IA32_RTIT_CTL.PSBFreq (see Section 33.2.8.2). Note, however, that the PSB period is not precise, it simply reflects the average number of output bytes that should pass between PSBs. The processor will make a best effort to insert PSB as quickly after the selected threshold is reached as possible. The processor also may send extra PSB packets for some micro-architectural conditions. PSB also serves as the leading packet for a set of “status-only” packets collectively known as PSB+ (Section 33.3.7).		
Application	When a PSB is seen, the decoder should interpret all following packets as “status only”, until either a PSBEND or OVF packet is encountered. “Status only” implies that the binding and ordering rules to which these packets normally adhere are ignored, and the state they carry can instead be applied to the IP payload in the FUP packet that is included.		

33.4.2.18 PSBEND Packet**Table 33-37. PSBEND Packet Definition**

Name	PSBEND Packet																																		
Packet Format	<table border="1"> <thead> <tr> <th></th> <th>7</th> <th>6</th> <th>5</th> <th>4</th> <th>3</th> <th>2</th> <th>1</th> <th>0</th> </tr> </thead> <tbody> <tr> <th>0</th> <td>0</td> <td>0</td> <td>0</td> <td>0</td> <td>0</td> <td>0</td> <td>1</td> <td>0</td> </tr> <tr> <th>1</th> <td>0</td> <td>0</td> <td>1</td> <td>0</td> <td>0</td> <td>0</td> <td>1</td> <td>1</td> </tr> </tbody> </table>									7	6	5	4	3	2	1	0	0	0	0	0	0	0	0	1	0	1	0	0	1	0	0	0	1	1
	7	6	5	4	3	2	1	0																											
0	0	0	0	0	0	0	1	0																											
1	0	0	1	0	0	0	1	1																											
Dependencies	TriggerEn	Generation Scenario	Always follows PSB packet, separated by PSB+ packets																																
Description	PSBEND is simply a terminator for the series of “status only” (PSB+) packets that follow PSB (Section 33.3.7).																																		
Application	When a PSBEND packet is seen, the decoder should cease to treat packets as “status only”.																																		

33.4.2.19 Maintenance (MNT) Packet

Table 33-38. MNT Packet Definition

Name	Maintenance (MNT) Packet																																																																																																														
Packet Format	<table border="1"> <thead> <tr> <th></th> <th>7</th> <th>6</th> <th>5</th> <th>4</th> <th>3</th> <th>2</th> <th>1</th> <th>0</th> </tr> </thead> <tbody> <tr> <td>0</td> <td>0</td> <td>0</td> <td>0</td> <td>0</td> <td>0</td> <td>0</td> <td>1</td> <td>0</td> </tr> <tr> <td>1</td> <td>1</td> <td>1</td> <td>0</td> <td>0</td> <td>0</td> <td>0</td> <td>1</td> <td>1</td> </tr> <tr> <td>2</td> <td>1</td> <td>0</td> <td>0</td> <td>0</td> <td>1</td> <td>0</td> <td>0</td> <td>0</td> </tr> <tr> <td>3</td> <td colspan="8">Payload[7:0]</td> </tr> <tr> <td>4</td> <td colspan="8">Payload[15:8]</td> </tr> <tr> <td>5</td> <td colspan="8">Payload[23:16]</td> </tr> <tr> <td>6</td> <td colspan="8">Payload[31:24]</td> </tr> <tr> <td>7</td> <td colspan="8">Payload[39:32]</td> </tr> <tr> <td>8</td> <td colspan="8">Payload[47:40]</td> </tr> <tr> <td>9</td> <td colspan="8">Payload[55:48]</td> </tr> <tr> <td>10</td> <td colspan="8">Payload[63:56]</td> </tr> </tbody> </table>				7	6	5	4	3	2	1	0	0	0	0	0	0	0	0	1	0	1	1	1	0	0	0	0	1	1	2	1	0	0	0	1	0	0	0	3	Payload[7:0]								4	Payload[15:8]								5	Payload[23:16]								6	Payload[31:24]								7	Payload[39:32]								8	Payload[47:40]								9	Payload[55:48]								10	Payload[63:56]							
	7	6	5	4	3	2	1	0																																																																																																							
0	0	0	0	0	0	0	1	0																																																																																																							
1	1	1	0	0	0	0	1	1																																																																																																							
2	1	0	0	0	1	0	0	0																																																																																																							
3	Payload[7:0]																																																																																																														
4	Payload[15:8]																																																																																																														
5	Payload[23:16]																																																																																																														
6	Payload[31:24]																																																																																																														
7	Payload[39:32]																																																																																																														
8	Payload[47:40]																																																																																																														
9	Payload[55:48]																																																																																																														
10	Payload[63:56]																																																																																																														
Dependencies	TriggerEn	Generation Scenario	Implementation specific.																																																																																																												
Description	This packet is generated by hardware, the payload meaning is model-specific.																																																																																																														
Application	Unless a decoder has been extended for a particular family/model/stepping to interpret MNT packet payloads, this packet should simply be ignored. It does not bind to any IP.																																																																																																														

33.4.2.20 PAD Packet

Table 33-39. PAD Packet Definition

Name	PAD Packet																				
Packet Format	<table border="1"> <thead> <tr> <th></th> <th>7</th> <th>6</th> <th>5</th> <th>4</th> <th>3</th> <th>2</th> <th>1</th> <th>0</th> </tr> </thead> <tbody> <tr> <td>0</td> <td>0</td> <td>0</td> <td>0</td> <td>0</td> <td>0</td> <td>0</td> <td>0</td> <td>0</td> </tr> </tbody> </table>				7	6	5	4	3	2	1	0	0	0	0	0	0	0	0	0	0
	7	6	5	4	3	2	1	0													
0	0	0	0	0	0	0	0	0													
Dependencies	TriggerEn	Generation Scenario	Implementation specific																		
Description	PAD is simply a NOP packet. Processor implementations may choose to add pad packets to improve packet alignment or for implementation-specific reasons.																				
Application	Ignore PAD packets.																				

33.4.2.21 PTWRITE (PTW) Packet

Table 33-40. PTW Packet Definition

Name	PTW Packet																																																																																																										
Packet Format	<table border="1"> <tr> <td></td> <td>7</td> <td>6</td> <td>5</td> <td>4</td> <td>3</td> <td>2</td> <td>1</td> <td>0</td> </tr> <tr> <td>0</td> <td>0</td> <td>0</td> <td>0</td> <td>0</td> <td>0</td> <td>0</td> <td>1</td> <td>0</td> </tr> <tr> <td>1</td> <td>IP</td> <td colspan="2">PayloadBytes</td> <td>1</td> <td>0</td> <td>0</td> <td>1</td> <td>0</td> </tr> <tr> <td>2</td> <td colspan="8">Payload[7:0]</td> </tr> <tr> <td>3</td> <td colspan="8">Payload[15:8]</td> </tr> <tr> <td>4</td> <td colspan="8">Payload[23:16]</td> </tr> <tr> <td>5</td> <td colspan="8">Payload[31:24]</td> </tr> <tr> <td>6</td> <td colspan="8">Payload[39:32]</td> </tr> <tr> <td>7</td> <td colspan="8">Payload[47:40]</td> </tr> <tr> <td>8</td> <td colspan="8">Payload[55:48]</td> </tr> <tr> <td>9</td> <td colspan="8">Payload[63:56]</td> </tr> </table>									7	6	5	4	3	2	1	0	0	0	0	0	0	0	0	1	0	1	IP	PayloadBytes		1	0	0	1	0	2	Payload[7:0]								3	Payload[15:8]								4	Payload[23:16]								5	Payload[31:24]								6	Payload[39:32]								7	Payload[47:40]								8	Payload[55:48]								9	Payload[63:56]							
	7	6	5	4	3	2	1	0																																																																																																			
0	0	0	0	0	0	0	1	0																																																																																																			
1	IP	PayloadBytes		1	0	0	1	0																																																																																																			
2	Payload[7:0]																																																																																																										
3	Payload[15:8]																																																																																																										
4	Payload[23:16]																																																																																																										
5	Payload[31:24]																																																																																																										
6	Payload[39:32]																																																																																																										
7	Payload[47:40]																																																																																																										
8	Payload[55:48]																																																																																																										
9	Payload[63:56]																																																																																																										
	<p>The PayloadBytes field indicates the number of bytes of payload that follow the header bytes. Encodings are as follows:</p> <table border="1"> <thead> <tr> <th>PayloadBytes</th> <th>Bytes of Payload</th> </tr> </thead> <tbody> <tr> <td>'00</td> <td>4</td> </tr> <tr> <td>'01</td> <td>8</td> </tr> <tr> <td>'10</td> <td>Reserved</td> </tr> <tr> <td>'11</td> <td>Reserved</td> </tr> </tbody> </table> <p>IP bit indicates if a FUP, whose payload will be the IP of the PTWRITE instruction, will follow.</p>								PayloadBytes	Bytes of Payload	'00	4	'01	8	'10	Reserved	'11	Reserved																																																																																									
PayloadBytes	Bytes of Payload																																																																																																										
'00	4																																																																																																										
'01	8																																																																																																										
'10	Reserved																																																																																																										
'11	Reserved																																																																																																										
Dependencies	TriggerEn && ContextEn && FilterEn && PTWEn	Generation Scenario	PTWRITE Instruction																																																																																																								
Description	Contains the value held in the PTWRITE operand. This packet is CYC-eligible, and hence will generate a CYC packet if IA32_RTIT_CTL.CYCEn=1 and any CYC Threshold has been reached.																																																																																																										
Application	Binds to the associated PTWRITE instruction. The IP of the PTWRITE will be provided by a following FUP, when PTW.IP=1.																																																																																																										

33.4.2.22 Execution Stop (EXSTOP) Packet

Table 33-41. EXSTOP Packet Definition

Name	EXSTOP Packet																													
Packet Format	<table border="1" data-bbox="337 380 1328 491"> <tr> <td></td> <td>7</td> <td>6</td> <td>5</td> <td>4</td> <td>3</td> <td>2</td> <td>1</td> <td>0</td> </tr> <tr> <td>0</td> <td>0</td> <td>0</td> <td>0</td> <td>0</td> <td>0</td> <td>0</td> <td>1</td> <td>0</td> </tr> <tr> <td>1</td> <td>IP</td> <td>1</td> <td>1</td> <td>0</td> <td>0</td> <td>0</td> <td>1</td> <td>0</td> </tr> </table> <p data-bbox="337 506 678 531">IP bit indicates if a FUP will follow.</p>				7	6	5	4	3	2	1	0	0	0	0	0	0	0	0	1	0	1	IP	1	1	0	0	0	1	0
	7	6	5	4	3	2	1	0																						
0	0	0	0	0	0	0	1	0																						
1	IP	1	1	0	0	0	1	0																						
Dependencies	TriggerEn && PwrEvtEn	Generation Scenario	C-state entry, P-state change, or other processor clock power-down. Includes : <ul style="list-style-type: none"> ▪ Entry to C-state deeper than C0.0 ▪ TM1/2 ▪ STPCLK# ▪ Frequency change due to IA32_CLOCK_MODULATION, Turbo 																											
Description	<p data-bbox="310 764 1458 821">This packet indicates that software execution has stopped due to processor clock powerdown. Later packets will indicate when execution resumes.</p> <p data-bbox="310 821 1458 905">If EXSTOP is generated while ContextEn is set, the IP bit will be set, and EXSTOP will be followed by a FUP packet containing the IP at which execution stopped. More precisely, this will be the IP of the oldest instruction that has not yet completed.</p> <p data-bbox="310 905 1458 961">This packet is CYC-eligible, and hence will generate a CYC packet if IA32_RTIT_CTL.CYCEn=1 and any CYC Threshold has been reached.</p>																													
Application	<p data-bbox="310 984 1458 1062">If a FUP follows EXSTOP (hence IP bit set), the EXSTOP can be bound to the FUP IP. Otherwise the IP is not known. Time of powerdown can be inferred from the preceding CYC, if CYCEn=1. Combined with the TSC at the time of wake (if TSCEn=1), this can be used to determine the duration of the powerdown.</p>																													

33.4.2.23 MWAIT Packet

Table 33-42. MWAIT Packet Definition

Name	MWAIT Packet																																																																																																										
Packet Format	<table border="1"> <thead> <tr> <th></th> <th>7</th> <th>6</th> <th>5</th> <th>4</th> <th>3</th> <th>2</th> <th>1</th> <th>0</th> </tr> </thead> <tbody> <tr> <td>0</td> <td>0</td> <td>0</td> <td>0</td> <td>0</td> <td>0</td> <td>0</td> <td>1</td> <td>0</td> </tr> <tr> <td>1</td> <td>1</td> <td>1</td> <td>0</td> <td>0</td> <td>0</td> <td>0</td> <td>1</td> <td>0</td> </tr> <tr> <td>2</td> <td colspan="8">MWAIT Hints[7:0]</td> </tr> <tr> <td>3</td> <td colspan="8">Reserved</td> </tr> <tr> <td>4</td> <td colspan="8">Reserved</td> </tr> <tr> <td>5</td> <td colspan="8">Reserved</td> </tr> <tr> <td>6</td> <td colspan="6">Reserved</td> <td colspan="2">EXT[1:0]</td> </tr> <tr> <td>7</td> <td colspan="8">Reserved</td> </tr> <tr> <td>8</td> <td colspan="8">Reserved</td> </tr> <tr> <td>9</td> <td colspan="8">Reserved</td> </tr> </tbody> </table>									7	6	5	4	3	2	1	0	0	0	0	0	0	0	0	1	0	1	1	1	0	0	0	0	1	0	2	MWAIT Hints[7:0]								3	Reserved								4	Reserved								5	Reserved								6	Reserved						EXT[1:0]		7	Reserved								8	Reserved								9	Reserved							
	7	6	5	4	3	2	1	0																																																																																																			
0	0	0	0	0	0	0	1	0																																																																																																			
1	1	1	0	0	0	0	1	0																																																																																																			
2	MWAIT Hints[7:0]																																																																																																										
3	Reserved																																																																																																										
4	Reserved																																																																																																										
5	Reserved																																																																																																										
6	Reserved						EXT[1:0]																																																																																																				
7	Reserved																																																																																																										
8	Reserved																																																																																																										
9	Reserved																																																																																																										
Dependencies	TriggerEn && PwrEvtEn && ContextEn	Generation Scenario	MWAIT, UMWAIT, or TPAUSE instructions, or I/O redirection to MWAIT, that complete without fault or VMexit.																																																																																																								
Description	<p>Indicates that an MWAIT operation to C-state deeper than C0.0 completed. The MWAIT hints and extensions passed in by software are exposed in the payload. For UMWAIT and TPAUSE, the EXT field holds the input register value that determines the optimized state requested.</p> <p>For entry to some highly optimized C0 sub-C-states, such as C0.1, no MWAIT packet is generated.</p> <p>This packet is CYC-eligible, and hence will generate a CYC packet if IA32_RTIT_CTL.CYCEn=1 and any CYC Threshold has been reached.</p>																																																																																																										
Application	The binding for the upcoming EXSTOP packet also applies to the MWAIT packet. See Section 33.4.2.22.																																																																																																										

33.4.2.24 Power Entry (PWRE) Packet

Table 33-43. PWRE Packet Definition

Name	PWRE Packet																																															
Packet Format	<table border="1" style="width: 100%; border-collapse: collapse;"> <thead> <tr> <th style="width: 10%;"></th> <th style="width: 10%;">7</th> <th style="width: 10%;">6</th> <th style="width: 10%;">5</th> <th style="width: 10%;">4</th> <th style="width: 10%;">3</th> <th style="width: 10%;">2</th> <th style="width: 10%;">1</th> <th style="width: 10%;">0</th> </tr> </thead> <tbody> <tr> <td>0</td> <td>0</td> <td>0</td> <td>0</td> <td>0</td> <td>0</td> <td>0</td> <td>1</td> <td>0</td> </tr> <tr> <td>1</td> <td>0</td> <td>0</td> <td>1</td> <td>0</td> <td>0</td> <td>0</td> <td>1</td> <td>0</td> </tr> <tr> <td>2</td> <td colspan="2">HW</td> <td colspan="6">Reserved</td> </tr> <tr> <td>3</td> <td colspan="4">Resolved Thread C-State</td> <td colspan="4">Resolved Thread Sub C-State</td> </tr> </tbody> </table>				7	6	5	4	3	2	1	0	0	0	0	0	0	0	0	1	0	1	0	0	1	0	0	0	1	0	2	HW		Reserved						3	Resolved Thread C-State				Resolved Thread Sub C-State			
	7	6	5	4	3	2	1	0																																								
0	0	0	0	0	0	0	1	0																																								
1	0	0	1	0	0	0	1	0																																								
2	HW		Reserved																																													
3	Resolved Thread C-State				Resolved Thread Sub C-State																																											
Dependencies	TriggerEn && PwrEvtEn	Generation Scenario	Transition to a C-state deeper than C0.0.																																													
Description	<p>Indicates processor entry to the resolved thread C-state and sub C-state indicated. The processor will remain in this C-state until either another PWRE indicates the processor has moved to a C-state deeper than C0.0, or a PWRX packet indicates a return to C0.0.</p> <p>For entry to some highly optimized C0 sub-C-states, such as C0.1, no PWRE packet is generated.</p> <p>Note that some CPUs may allow MWAIT to request a deeper C-state than is supported by the core. These deeper C-states may have platform-level implications that differentiate them. However, the PWRE packet will provide only the resolved thread C-state, which will not exceed that supported by the core.</p> <p>If the C-state entry was initiated by hardware, rather than a direct software request (such as MWAIT, UMWAIT, TPAUSE, HLT, or shutdown), the HW bit will be set to indicate this. Hardware Duty Cycling (see Section 15.5, "Hardware Duty Cycling (HDC)," in the Intel® 64 and IA-32 Architectures Software Developer's Manual, Volume 3B) is an example of such a case.</p>																																															
Application	<p>When transitioning from C0.0 to a deeper C-state, the PWRE packet will be followed by an EXSTOP. If that EXSTOP packet has the IP bit set, then the following FUP will provide the IP at which the C-state entry occurred. Subsequent PWRE packets generated before the next PWRX should bind to the same IP.</p>																																															

33.4.2.25 Power Exit (PWRX) Packet

Table 33-44. PWRX Packet Definition

Name	PWRX Packet																																																																										
Packet Format	<table border="1"> <tr> <td></td> <td>7</td> <td>6</td> <td>5</td> <td>4</td> <td>3</td> <td>2</td> <td>1</td> <td>0</td> </tr> <tr> <td>0</td> <td>0</td> <td>0</td> <td>0</td> <td>0</td> <td>0</td> <td>0</td> <td>1</td> <td>0</td> </tr> <tr> <td>1</td> <td>1</td> <td>0</td> <td>1</td> <td>0</td> <td>0</td> <td>0</td> <td>1</td> <td>0</td> </tr> <tr> <td>2</td> <td colspan="4">Last Core C-State</td> <td colspan="4">Deepest Core C-State</td> </tr> <tr> <td>3</td> <td colspan="4">Reserved</td> <td colspan="4">Wake Reason</td> </tr> <tr> <td>4</td> <td colspan="8">Reserved</td> </tr> <tr> <td>5</td> <td colspan="8">Reserved</td> </tr> <tr> <td>6</td> <td colspan="8">Reserved</td> </tr> </table>				7	6	5	4	3	2	1	0	0	0	0	0	0	0	0	1	0	1	1	0	1	0	0	0	1	0	2	Last Core C-State				Deepest Core C-State				3	Reserved				Wake Reason				4	Reserved								5	Reserved								6	Reserved							
	7	6	5	4	3	2	1	0																																																																			
0	0	0	0	0	0	0	1	0																																																																			
1	1	0	1	0	0	0	1	0																																																																			
2	Last Core C-State				Deepest Core C-State																																																																						
3	Reserved				Wake Reason																																																																						
4	Reserved																																																																										
5	Reserved																																																																										
6	Reserved																																																																										
Dependencies	TriggerEn && PwrEvtEn	Generation Scenario	Transition from a C-state deeper than C0.0 to C0.																																																																								
Description	<p>Indicates processor return to thread C0 from a C-state deeper than C0.0. For return from some highly optimized C0 sub-C-states, such as C0.1, no PWRX packet is generated. The Last Core C-State field provides the MWAIT encoding for the core C-state at the time of the wake. The Deepest Core C-State provides the MWAIT encoding for the deepest core C-state achieved during the sleep session, or since leaving thread C0. MWAIT encodings for C-states can be found in Table 4-11 in the Intel® 64 and IA-32 Architectures Software Developer's Manual, Volume 2B. Note that these values reflect only the core C-state, and hence will not exceed the maximum supported core C-state, even if deeper C-states can be requested. The Wake Reason field is one-hot, encoded as follows:</p> <table border="1"> <thead> <tr> <th>Bit</th> <th>Field</th> <th>Meaning</th> </tr> </thead> <tbody> <tr> <td>0</td> <td>Interrupt</td> <td>Wake due to external interrupt received.</td> </tr> <tr> <td>1</td> <td>Timer Deadline</td> <td>Wake due to timer expiration, such as UMWAIT/TPAUSE TSC-quanta.</td> </tr> <tr> <td>2</td> <td>Store to Monitored Address</td> <td>Wake due to store to monitored address.</td> </tr> <tr> <td>3</td> <td>HW Wake</td> <td>Wake due to hardware autonomous condition, such as HDC.</td> </tr> </tbody> </table>			Bit	Field	Meaning	0	Interrupt	Wake due to external interrupt received.	1	Timer Deadline	Wake due to timer expiration, such as UMWAIT/TPAUSE TSC-quanta.	2	Store to Monitored Address	Wake due to store to monitored address.	3	HW Wake	Wake due to hardware autonomous condition, such as HDC.																																																									
Bit	Field	Meaning																																																																									
0	Interrupt	Wake due to external interrupt received.																																																																									
1	Timer Deadline	Wake due to timer expiration, such as UMWAIT/TPAUSE TSC-quanta.																																																																									
2	Store to Monitored Address	Wake due to store to monitored address.																																																																									
3	HW Wake	Wake due to hardware autonomous condition, such as HDC.																																																																									
Application	PWRX will always apply to the same IP as the PWRE. The time of wake can be discerned from (optional) timing packets that precede PWRX.																																																																										

33.4.2.26 Block Begin Packet (BBP)

Table 33-45. Block Begin Packet Definition

Name	BBP																																						
Packet Format	<table border="1"> <tr> <td></td> <td>7</td> <td>6</td> <td>5</td> <td>4</td> <td>3</td> <td>2</td> <td>1</td> <td>0</td> </tr> <tr> <td>0</td> <td>0</td> <td>0</td> <td>0</td> <td>0</td> <td>0</td> <td>0</td> <td>1</td> <td>0</td> </tr> <tr> <td>1</td> <td>0</td> <td>1</td> <td>1</td> <td>0</td> <td>0</td> <td>0</td> <td>1</td> <td>1</td> </tr> <tr> <td>2</td> <td>SZ</td> <td colspan="2">Reserved</td> <td colspan="5">Type[4:0]</td> </tr> </table>				7	6	5	4	3	2	1	0	0	0	0	0	0	0	0	1	0	1	0	1	1	0	0	0	1	1	2	SZ	Reserved		Type[4:0]				
	7	6	5	4	3	2	1	0																															
0	0	0	0	0	0	0	1	0																															
1	0	1	1	0	0	0	1	1																															
2	SZ	Reserved		Type[4:0]																																			
Dependencies	TriggerEn	Generation Scenario	PEBS event, if IA32_PEBS_ENABLE.OUTPUT=1.																																				
Description	<p>This packet indicates the beginning of a block of packets which are collectively tied to a single event or instruction. The size of the block item payloads within this block is provided by the Size (SZ) bit: SZ=0: 8-byte block items SZ=1: 4-byte block items The meaning of the BIP payloads is provided by the Type field:</p> <table border="1"> <thead> <tr> <th>BBP.Type</th> <th>Block name</th> </tr> </thead> <tbody> <tr> <td>0x00</td> <td>Reserved</td> </tr> <tr> <td>0x01</td> <td>General-Purpose Registers</td> </tr> <tr> <td>0x02..0x03</td> <td>Reserved</td> </tr> <tr> <td>0x04</td> <td>PEBS Basic</td> </tr> <tr> <td>0x05</td> <td>PEBS Memory</td> </tr> <tr> <td>0x06..0x07</td> <td>Reserved</td> </tr> <tr> <td>0x08</td> <td>LBR Block 0</td> </tr> <tr> <td>0x09</td> <td>LBR Block 1</td> </tr> <tr> <td>0x0A</td> <td>LBR Block 2</td> </tr> <tr> <td>0x0B..0x0F</td> <td>Reserved</td> </tr> <tr> <td>0x10</td> <td>XMM Registers</td> </tr> <tr> <td>0x11..0x1F</td> <td>Reserved</td> </tr> </tbody> </table>			BBP.Type	Block name	0x00	Reserved	0x01	General-Purpose Registers	0x02..0x03	Reserved	0x04	PEBS Basic	0x05	PEBS Memory	0x06..0x07	Reserved	0x08	LBR Block 0	0x09	LBR Block 1	0x0A	LBR Block 2	0x0B..0x0F	Reserved	0x10	XMM Registers	0x11..0x1F	Reserved										
BBP.Type	Block name																																						
0x00	Reserved																																						
0x01	General-Purpose Registers																																						
0x02..0x03	Reserved																																						
0x04	PEBS Basic																																						
0x05	PEBS Memory																																						
0x06..0x07	Reserved																																						
0x08	LBR Block 0																																						
0x09	LBR Block 1																																						
0x0A	LBR Block 2																																						
0x0B..0x0F	Reserved																																						
0x10	XMM Registers																																						
0x11..0x1F	Reserved																																						
Application	<p>A BBP will always be followed by a Block End Packet (BEP), and when the block is generated while ContextEn=1 that BEP will have IP=1 and be followed by a FUP that provides the IP to which the block should be bound. Note that, in addition to BEP, a block can be terminated by a BBP (indicating the start of a new block) or an OVF packet.</p>																																						

33.4.2.27 Block Item Packet (BIP)

Table 33-46. Block Item Packet Definition

Name	BIP																																																																																																																																																		
Packet Format	<p>If the preceding BBP.SZ=0:</p> <table border="1"> <thead> <tr> <th></th> <th>7</th> <th>6</th> <th>5</th> <th>4</th> <th>3</th> <th>2</th> <th>1</th> <th>0</th> </tr> </thead> <tbody> <tr> <td>0</td> <td colspan="5">ID[5:0]</td> <td>1</td> <td>0</td> <td>0</td> </tr> <tr> <td>1</td> <td colspan="8">Payload[7:0]</td> </tr> <tr> <td>2</td> <td colspan="8">Payload[15:8]</td> </tr> <tr> <td>3</td> <td colspan="8">Payload[23:16]</td> </tr> <tr> <td>4</td> <td colspan="8">Payload[31:24]</td> </tr> <tr> <td>5</td> <td colspan="8">Payload[39:32]</td> </tr> <tr> <td>6</td> <td colspan="8">Payload[47:40]</td> </tr> <tr> <td>7</td> <td colspan="8">Payload[55:48]</td> </tr> <tr> <td>8</td> <td colspan="8">Payload[63:56]</td> </tr> </tbody> </table> <p>If the preceding BBP.SZ=1:</p> <table border="1"> <thead> <tr> <th></th> <th>7</th> <th>6</th> <th>5</th> <th>4</th> <th>3</th> <th>2</th> <th>1</th> <th>0</th> </tr> </thead> <tbody> <tr> <td>0</td> <td colspan="5">ID[5:0]</td> <td>1</td> <td>0</td> <td>0</td> </tr> <tr> <td>1</td> <td colspan="8">Payload[7:0]</td> </tr> <tr> <td>2</td> <td colspan="8">Payload[15:8]</td> </tr> <tr> <td>3</td> <td colspan="8">Payload[23:16]</td> </tr> <tr> <td>4</td> <td colspan="8">Payload[31:24]</td> </tr> </tbody> </table>				7	6	5	4	3	2	1	0	0	ID[5:0]					1	0	0	1	Payload[7:0]								2	Payload[15:8]								3	Payload[23:16]								4	Payload[31:24]								5	Payload[39:32]								6	Payload[47:40]								7	Payload[55:48]								8	Payload[63:56]									7	6	5	4	3	2	1	0	0	ID[5:0]					1	0	0	1	Payload[7:0]								2	Payload[15:8]								3	Payload[23:16]								4	Payload[31:24]							
	7	6	5	4	3	2	1	0																																																																																																																																											
0	ID[5:0]					1	0	0																																																																																																																																											
1	Payload[7:0]																																																																																																																																																		
2	Payload[15:8]																																																																																																																																																		
3	Payload[23:16]																																																																																																																																																		
4	Payload[31:24]																																																																																																																																																		
5	Payload[39:32]																																																																																																																																																		
6	Payload[47:40]																																																																																																																																																		
7	Payload[55:48]																																																																																																																																																		
8	Payload[63:56]																																																																																																																																																		
	7	6	5	4	3	2	1	0																																																																																																																																											
0	ID[5:0]					1	0	0																																																																																																																																											
1	Payload[7:0]																																																																																																																																																		
2	Payload[15:8]																																																																																																																																																		
3	Payload[23:16]																																																																																																																																																		
4	Payload[31:24]																																																																																																																																																		
Dependencies	TriggerEn	Generation Scenario	See BBP.																																																																																																																																																
Description	<p>The size of the BIP payload is determined by the Size field in the preceding BBP packet. The BIP header provides the ID value that, when combined with the Type field from the preceding BBP, uniquely identifies the state value held in the BIP payload. See Table 33-47 below for the complete list.</p>																																																																																																																																																		
Application	See BBP.																																																																																																																																																		

BIP State Value Encodings

The table below provides the encoding values for all defined block items. State items that are larger than 8 bytes, such as XMM register values, are broken into multiple 8-byte components. BIP packets with Size=1 (4 byte payload) will provide only the lower 4 bytes of the associated state value.

Table 33-47. BIP Encodings

BBP.Type	BIP.ID	State Value
General-Purpose Registers		
0x01	0x00	R/EFLAGS
0x01	0x01	R/EIP
0x01	0x02	R/EAX
0x01	0x03	R/ECX

Table 33-47. BIP Encodings (Contd.)

BBP.Type	BIP.ID	State Value
0x01	0x04	R/EDX
0x01	0x05	R/EBX
0x01	0x06	R/ESP
0x01	0x07	R/EBP
0x01	0x08	R/ESI
0x01	0x09	R/EDI
0x01	0x0A	R8
0x01	0x0B	R9
0x01	0x0C	R10
0x01	0x0D	R11
0x01	0x0E	R12
0x01	0x0F	R13
0x01	0x10	R14
0x01	0x11	R15
PEBS Basic Info (Section 20.9.2.2.1)		
0x04	0x00	Instruction Pointer
0x04	0x01	Applicable Counters
0x04	0x02	Timestamp
PEBS Memory Info (Section 20.9.2.2.2)		
0x05	0x00	MemAccessAddress
0x05	0x01	MemAuxInfo
0x05	0x02	MemAccessLatency
0x05	0x03	TSXAuxInfo
LBR_0		
0x08	0x00	LBR[TOS-0]_FROM_IP
0x08	0x01	LBR[TOS-0]_TO_IP
0x08	0x02	LBR[TOS-0]_INFO
0x08	0x03	LBR[TOS-1]_FROM_IP
0x08	0x04	LBR[TOS-1]_TO_IP
0x08	0x05	LBR[TOS-1]_INFO
0x08	0x06	LBR[TOS-2]_FROM_IP
0x08	0x07	LBR[TOS-2]_TO_IP
0x08	0x08	LBR[TOS-2]_INFO
0x08	0x09	LBR[TOS-3]_FROM_IP
0x08	0x0A	LBR[TOS-3]_TO_IP
0x08	0x0B	LBR[TOS-3]_INFO
0x08	0x0C	LBR[TOS-4]_FROM_IP
0x08	0x0D	LBR[TOS-4]_TO_IP

Table 33-47. BIP Encodings (Contd.)

BBP.Type	BIP.ID	State Value
0x08	0x0E	LBR[TOS-4]_INFO
0x08	0x0F	LBR[TOS-5]_FROM_IP
0x08	0x10	LBR[TOS-5]_TO_IP
0x08	0x11	LBR[TOS-5]_INFO
0x08	0x12	LBR[TOS-6]_FROM_IP
0x08	0x13	LBR[TOS-6]_TO_IP
0x08	0x14	LBR[TOS-6]_INFO
0x08	0x15	LBR[TOS-7]_FROM_IP
0x08	0x16	LBR[TOS-7]_TO_IP
0x08	0x17	LBR[TOS-7]_INFO
0x08	0x18	LBR[TOS-8]_FROM_IP
0x08	0x19	LBR[TOS-8]_TO_IP
0x08	0x1A	LBR[TOS-8]_INFO
0x08	0x1B	LBR[TOS-9]_FROM_IP
0x08	0x1C	LBR[TOS-9]_TO_IP
0x08	0x1D	LBR[TOS-9]_INFO
0x08	0x1E	LBR[TOS-10]_FROM_IP
0x08	0x1F	LBR[TOS-10]_TO_IP
LBR_1		
0x09	0x00	LBR[TOS-10]_INFO
0x09	0x01	LBR[TOS-11]_FROM_IP
0x09	0x02	LBR[TOS-11]_TO_IP
0x09	0x03	LBR[TOS-11]_INFO
0x09	0x04	LBR[TOS-12]_FROM_IP
0x09	0x05	LBR[TOS-12]_TO_IP
0x09	0x06	LBR[TOS-12]_INFO
0x09	0x07	LBR[TOS-13]_FROM_IP
0x09	0x08	LBR[TOS-13]_TO_IP
0x09	0x09	LBR[TOS-13]_INFO
0x09	0x0A	LBR[TOS-14]_FROM_IP
0x09	0x0B	LBR[TOS-14]_TO_IP
0x09	0x0C	LBR[TOS-14]_INFO
0x09	0x0D	LBR[TOS-15]_FROM_IP
0x09	0x0E	LBR[TOS-15]_TO_IP
0x09	0x0F	LBR[TOS-15]_INFO
0x09	0x10	LBR[TOS-16]_FROM_IP
0x09	0x11	LBR[TOS-16]_TO_IP
0x09	0x12	LBR[TOS-16]_INFO

Table 33-47. BIP Encodings (Contd.)

BBP.Type	BIP.ID	State Value
0x09	0x13	LBR[TOS-17]_FROM_IP
0x09	0x14	LBR[TOS-17]_TO_IP
0x09	0x15	LBR[TOS-17]_INFO
0x09	0x16	LBR[TOS-18]_FROM_IP
0x09	0x17	LBR[TOS-18]_TO_IP
0x09	0x18	LBR[TOS-18]_INFO
0x09	0x19	LBR[TOS-19]_FROM_IP
0x09	0x1A	LBR[TOS-19]_TO_IP
0x09	0x1B	LBR[TOS-19]_INFO
0x09	0x1C	LBR[TOS-20]_FROM_IP
0x09	0x1D	LBR[TOS-20]_TO_IP
0x09	0x1E	LBR[TOS-20]_INFO
0x09	0x1F	LBR[TOS-21]_FROM_IP
LBR_2		
0x0A	0x00	LBR[TOS-21]_TO_IP
0x0A	0x01	LBR[TOS-21]_INFO
0x0A	0x02	LBR[TOS-22]_FROM_IP
0x0A	0x03	LBR[TOS-22]_TO_IP
0x0A	0x04	LBR[TOS-22]_INFO
0x0A	0x05	LBR[TOS-23]_FROM_IP
0x0A	0x06	LBR[TOS-23]_TO_IP
0x0A	0x07	LBR[TOS-23]_INFO
0x0A	0x08	LBR[TOS-24]_FROM_IP
0x0A	0x09	LBR[TOS-24]_TO_IP
0x0A	0x0A	LBR[TOS-24]_INFO
0x0A	0x0B	LBR[TOS-25]_FROM_IP
0x0A	0x0C	LBR[TOS-25]_TO_IP
0x0A	0x0D	LBR[TOS-25]_INFO
0x0A	0x0E	LBR[TOS-26]_FROM_IP
0x0A	0x0F	LBR[TOS-26]_TO_IP
0x0A	0x10	LBR[TOS-26]_INFO
0x0A	0x11	LBR[TOS-27]_FROM_IP
0x0A	0x12	LBR[TOS-27]_TO_IP
0x0A	0x13	LBR[TOS-27]_INFO
0x0A	0x14	LBR[TOS-28]_FROM_IP
0x0A	0x15	LBR[TOS-28]_TO_IP
0x0A	0x16	LBR[TOS-28]_INFO
0x0A	0x17	LBR[TOS-29]_FROM_IP

Table 33-47. BIP Encodings (Contd.)

BBP.Type	BIP.ID	State Value
0x0A	0x18	LBR[TOS-29]_TO_IP
0x0A	0x19	LBR[TOS-29]_INFO
0x0A	0x1A	LBR[TOS-30]_FROM_IP
0x0A	0x1B	LBR[TOS-30]_TO_IP
0x0A	0x1C	LBR[TOS-30]_INFO
0x0A	0x1D	LBR[TOS-31]_FROM_IP
0x0A	0x1E	LBR[TOS-31]_TO_IP
0x0A	0x1F	LBR[TOS-31]_INFO
XMM Registers		
0x10	0x00	XMM0_Q0
0x10	0x01	XMM0_Q1
0x10	0x02	XMM1_Q0
0x10	0x03	XMM1_Q1
0x10	0x04	XMM2_Q0
0x10	0x05	XMM2_Q1
0x10	0x06	XMM3_Q0
0x10	0x07	XMM3_Q1
0x10	0x08	XMM4_Q0
0x10	0x09	XMM4_Q1
0x10	0x0A	XMM5_Q0
0x10	0x0B	XMM5_Q1
0x10	0x0C	XMM6_Q0
0x10	0x0D	XMM6_Q1
0x10	0x0E	XMM7_Q0
0x10	0x0F	XMM7_Q1
0x10	0x10	XMM8_Q0
0x10	0x11	XMM8_Q1
0x10	0x12	XMM9_Q0
0x10	0x13	XMM9_Q1
0x10	0x14	XMM10_Q0
0x10	0x15	XMM10_Q1
0x10	0x16	XMM11_Q0
0x10	0x17	XMM11_Q1
0x10	0x18	XMM12_Q0
0x10	0x19	XMM12_Q1
0x10	0x1A	XMM13_Q0
0x10	0x1B	XMM13_Q1
0x10	0x1C	XMM14_Q0

Table 33-47. BIP Encodings (Contd.)

BBP.Type	BIP.ID	State Value
0x10	0x1D	XMM14_Q1
0x10	0x1E	XMM15_Q0
0x10	0x1F	XMM15_Q1

33.4.2.28 Block End Packet (BEP)

Table 33-48. Block End Packet Definition

Name	BEP																																		
Packet Format	<table border="1"> <thead> <tr> <th></th> <th>7</th> <th>6</th> <th>5</th> <th>4</th> <th>3</th> <th>2</th> <th>1</th> <th>0</th> </tr> </thead> <tbody> <tr> <th>0</th> <td>0</td> <td>0</td> <td>0</td> <td>0</td> <td>0</td> <td>0</td> <td>1</td> <td>0</td> </tr> <tr> <th>1</th> <td>IP</td> <td>0</td> <td>1</td> <td>1</td> <td>0</td> <td>0</td> <td>1</td> <td>1</td> </tr> </tbody> </table>									7	6	5	4	3	2	1	0	0	0	0	0	0	0	0	1	0	1	IP	0	1	1	0	0	1	1
	7	6	5	4	3	2	1	0																											
0	0	0	0	0	0	0	1	0																											
1	IP	0	1	1	0	0	1	1																											
Dependencies	TriggerEn	Generation Scenario	See BBP.																																
Description	Indicates the end of a packet block. The IP bit indicates if a FUP will follow, and will be set if ContextEn=1.																																		
Application	The block, from initial BBP to the BEP, binds to the FUP IP, if IP=1, and consumes the FUP.																																		

33.4.2.29 Control Flow Event (CFE) Packet

Table 33-49. Control Flow Event Packet Definition

Name	CFE																																															
Packet Format	<table border="1"> <tr> <td></td> <td>7</td> <td>6</td> <td>5</td> <td>4</td> <td>3</td> <td>2</td> <td>1</td> <td>0</td> </tr> <tr> <td>0</td> <td>0</td> <td>0</td> <td>0</td> <td>0</td> <td>0</td> <td>0</td> <td>1</td> <td>0</td> </tr> <tr> <td>1</td> <td>0</td> <td>0</td> <td>0</td> <td>1</td> <td>0</td> <td>0</td> <td>1</td> <td>1</td> </tr> <tr> <td>2</td> <td>IP</td> <td colspan="2">Reserved</td> <td colspan="5">Type[4:0]</td> </tr> <tr> <td>3</td> <td colspan="8">Vector[7:0]</td> </tr> </table> <p>IP bit indicates if a stand-alone FUP will follow.</p>				7	6	5	4	3	2	1	0	0	0	0	0	0	0	0	1	0	1	0	0	0	1	0	0	1	1	2	IP	Reserved		Type[4:0]					3	Vector[7:0]							
	7	6	5	4	3	2	1	0																																								
0	0	0	0	0	0	0	1	0																																								
1	0	0	0	1	0	0	1	1																																								
2	IP	Reserved		Type[4:0]																																												
3	Vector[7:0]																																															
Dependencies	IA32_RTIT_CTL.EventEn && TriggerEn && ContextEn On ContextEn transitions, the CFE will be generated regardless of direction (1→0 or 0→1). VM exit is an exception, where CFE.VMEXIT depends only on the prior value of ContextEn.	Generation Scenario	Software interrupt, external interrupt, user interrupt, or exception, including those injected on VM entry. INIT, SIPI, SMI, RSM, IRET, Shutdown. VM exit, if "Conceal VMX in PT" VMCS exit control is 0. VM entry, if "Conceal VMX in PT" VMCS entry control is 0. TSX Abort.																																													
Description	<p>This packet indicates that an asynchronous event or related event (see list above) has occurred. The type of event is provided in the packet (see Table 33-50 below), and, if the IP bit is set, the IP at which the event occurred is provided in a stand-alone FUP packet that follows. Further, in the case of an interrupt or exception, the vector field provides the vector of the event.</p> <p>The IP bit will be set only when ContextEn=1 before the event is taken, and either BranchEn=0 or else no FUP is generated for this event by BranchEn=1. There are some cases, such as SIPI and RSM, where no FUP is generated. Note that events that are not delivered to software, such as nested events or events which cause a VM exit, do not generate CFE packets.</p>																																															
Application	If the IP bit is set, a FUP will follow that is stand-alone (not part of a compound packet event), and the CFE consumes the FUP. If the IP bit is not set, the CFE binds to the next FUP if PacketEn=1 (hence the CFE comes after a TIP.PGE but before the next TIP.PGD), and is stand-alone if PacketEn=0.																																															

CFE Packet Type and Vector Fields

Every CFE has a Type field, which provides the type of event which generated the packet. For a subset of CFE Types, the CFE.Vector field may be valid. Details on these fields, as well as the IP to be expected in any following FUP packet, are provided in the table below.

Table 33-50. CFE Packet Type and Vector Fields Details

CFE Subtype	Type	Vector	FUP IP	Details
INTR	0x1	Event Vector	Varies	Used for interrupts (external and software), Exceptions, Faults, and NMI. FUP contains that address of the instruction that has not completed (NLIP for trap events, CLIP for fault events).
IRET	0x2	Invalid	CLIP	
SMI	0x3	Invalid	NLIP	
RSM	0x4	Invalid	None	
SIPI	0x5	SIPI Vector	None	
INIT	0x6	Invalid	NLIP	
VMENTRY	0x7	Invalid	CLIP	FUP contains IP of VMLAUNCH/VMRESUME.

Table 33-50. CFE Packet Type and Vector Fields Details (Contd.)

CFE Subtype	Type	Vector	FUP IP	Details
VMEXIT	0x8	Invalid	Varies	FUP IP varies depending on type of VM exit, but will be the address of the instruction that has not completed. Will be consistent with Guest IP saved in VMCS.
VMEXIT_INTR	0x9	Event Vector	Varies	Sent in cases where VM exit was caused by an INTR event (interrupt, exception, fault, or NMI). Vector provided is for the event which caused the VM exit. FUP IP behavior matches that of INTR type above.
SHUTDOWN	0xa	Invalid	Varies	FUP IP varies depending on the type of event that caused shutdown, but will be the address of the instruction that has not completed.
Reserved	0xb	N/A	N/A	
UINTR	0xc	User Interrupt Vector	NLIP	User interrupt delivered.
UIRET	0xd	Invalid	CLIP	Exiting from user interrupt routine.
Reserved	0xe...0x1f	N/A	N/A	Reserved

33.4.2.30 Event Data (EVD) Packet

Table 33-51. Event Data Packet Definition

Name	EVD																																																																																																														
Packet Format	<table border="1"> <tr> <td></td> <td>7</td> <td>6</td> <td>5</td> <td>4</td> <td>3</td> <td>2</td> <td>1</td> <td>0</td> </tr> <tr> <td>0</td> <td>0</td> <td>0</td> <td>0</td> <td>0</td> <td>0</td> <td>0</td> <td>1</td> <td>0</td> </tr> <tr> <td>1</td> <td>0</td> <td>1</td> <td>0</td> <td>1</td> <td>0</td> <td>0</td> <td>1</td> <td>1</td> </tr> <tr> <td>2</td> <td colspan="2">Reserved</td> <td colspan="6">Type[5:0]</td> </tr> <tr> <td>3</td> <td colspan="8">Payload[7:0]</td> </tr> <tr> <td>4</td> <td colspan="8">Payload[15:8]</td> </tr> <tr> <td>5</td> <td colspan="8">Payload[23:16]</td> </tr> <tr> <td>6</td> <td colspan="8">Payload[31:24]</td> </tr> <tr> <td>7</td> <td colspan="8">Payload[39:32]</td> </tr> <tr> <td>8</td> <td colspan="8">Payload[47:40]</td> </tr> <tr> <td>9</td> <td colspan="8">Payload[55:48]</td> </tr> <tr> <td>10</td> <td colspan="8">Payload[63:56]</td> </tr> </table>				7	6	5	4	3	2	1	0	0	0	0	0	0	0	0	1	0	1	0	1	0	1	0	0	1	1	2	Reserved		Type[5:0]						3	Payload[7:0]								4	Payload[15:8]								5	Payload[23:16]								6	Payload[31:24]								7	Payload[39:32]								8	Payload[47:40]								9	Payload[55:48]								10	Payload[63:56]							
	7	6	5	4	3	2	1	0																																																																																																							
0	0	0	0	0	0	0	1	0																																																																																																							
1	0	1	0	1	0	0	1	1																																																																																																							
2	Reserved		Type[5:0]																																																																																																												
3	Payload[7:0]																																																																																																														
4	Payload[15:8]																																																																																																														
5	Payload[23:16]																																																																																																														
6	Payload[31:24]																																																																																																														
7	Payload[39:32]																																																																																																														
8	Payload[47:40]																																																																																																														
9	Payload[55:48]																																																																																																														
10	Payload[63:56]																																																																																																														
Dependencies	IA32_RTIT_CTL.EventEn && TriggerEn && ContextEn	Generation Scenario	Page fault, including those injected on VM entry. VM exit, if "Suppress VMX packets on exit" VMCS exit control is 0.																																																																																																												
Description	<p>Provides additional data about the event that caused the following CFE. The Payload field is dictated by the Type.</p> <table border="1"> <thead> <tr> <th>Type</th> <th>Payload</th> </tr> </thead> <tbody> <tr> <td>'000000</td> <td>Page Fault Linear Address, same as CR2 (PFA)</td> </tr> <tr> <td>'000001</td> <td>VMX Exit Qualification (VMXQ)</td> </tr> <tr> <td>'000010</td> <td>VMX Exit Reason (VMXR)</td> </tr> <tr> <td>'000011 - '111111</td> <td>Reserved</td> </tr> </tbody> </table> <p>EVD packets are never generated in cases where a CFE is not.</p>			Type	Payload	'000000	Page Fault Linear Address, same as CR2 (PFA)	'000001	VMX Exit Qualification (VMXQ)	'000010	VMX Exit Reason (VMXR)	'000011 - '111111	Reserved																																																																																																		
Type	Payload																																																																																																														
'000000	Page Fault Linear Address, same as CR2 (PFA)																																																																																																														
'000001	VMX Exit Qualification (VMXQ)																																																																																																														
'000010	VMX Exit Reason (VMXR)																																																																																																														
'000011 - '111111	Reserved																																																																																																														
Application	EVD packets bind to the same IP (if any) as the subsequent CFE packet.																																																																																																														

33.5 TRACING IN VMX OPERATION

On processors that IA32_VMX_MISC[bit 14] reports 1, TraceEn can be set in VMX operation. The VMM can configure specific VMX controls to control what virtualization-specific data is included within the trace packets (see Section 33.5.1 for details). The VMM can also configure the VMCS to limit tracing to non-root operation, or to trace across both root and non-root operation. The VMCS controls exist to simplify virtualization of Intel PT for guest use, including the "Clear IA32_RTIT_CTL" exit control (See Section 25.7.1), "Load IA32_RTIT_CTL" entry control (See Section 25.8.1), and "Intel PT uses guest physical addresses" execution control (See Section 26.5.3).

For older processors that do not support these VMCS controls, the MSR-load areas used by VMX transitions can be employed by the VMM to restrict tracing to the desired context. See Section 33.5.2 for details. Tracing with SMM Transfer Monitor is described in Section 33.6.

33.5.1 VMX-Specific Packets and VMCS Controls

In all of the usages of VMX and Intel PT, a decoder in the host or VMM context can identify the occurrences of VMX transitions with the aid of VMX-specific packets. There are four kinds of packets relevant to VMX:

- **VMCS packet.** The VMX transitions of individual VMs can be distinguished by a decoder using the VMCS-pointer field in a VMCS packet. A VMCS packet is sent on a successful execution of VMPTRLD, and its VMCS-pointer field stores the VMCS pointer loaded by that execution. See Section 33.4.2.15 for details.
- **The NR (non-root) bit in a PIP packet.** Normally, the NR bit is set in any PIP packet generated in VMX non-root operation. In addition, PIP packets are generated with each VM entry and VM exit. Thus a transition of the NR bit from 0 to 1 indicates the occurrence of a VM entry, and a transition of 1 to 0 indicates the occurrence of a VM exit.
- **CFE packet.** Identifies VM exit and VM entry operations.
- **EVD packet.** Provides the exit reason and exit qualification for VM exits.

There are VMX controls that a VMM can set to conceal some of this VMX-specific information (by suppressing its recording) and thereby prevent it from leaking across virtualization boundaries. There is one of these controls (each of which is called “conceal VMX from PT”) of each type of VMX control.

Table 33-52. VMX Controls For Intel Processor Trace

Type of VMX Control	Bit Position ¹	Value	Behavior
Secondary processor-based VM-execution control	19	0	Each PIP generated in VM non-root operation will set the NR bit. PSB+ in VMX non-root operation will include the VMCS packet, to ensure that the decoder knows which guest is currently in use.
		1	Each PIP generated in VMX non-root operation will clear the NR bit. PSB+ in VMX non-root operation will not include the VMCS packet.
VM-exit control	24	0	Each VM exit generates a PIP in which the NR bit is clear, and a CFE/EVD if Event Trace is enabled. In addition, SMM VM exits generate VMCS packets.
		1	VM exits do not generate PIPs, CFEs, or EVDs, and no VMCS packets are generated on SMM VM exits.
VM-entry control	17	0	Each VM entry generates a PIP in which the NR bit is set (except VM entries that return from SMM to VMX root operation), and a CFE if Event Trace is enabled. In addition, VM entries that return from SMM generate VMCS packets.
		1	VM entries do not generate PIPs or CFEs, and no VMCS packets are generated on VM entries that return from SMM.

NOTES:

1. These are the positions of the control bits in the relevant VMX control fields.

The 0-settings of these VMX controls enable all VMX-specific packet information. The scenarios that would use these default settings also do not require the VMM to use VMX MSR-load areas to enable and disable trace-packet generation across VMX transitions.

If IA32_VMX_MISC[bit 14] reports 0, the 1-settings of the VMX controls in Table 33-52 are not supported, and VM entry will fail on any attempt to set them.

33.5.2 Managing Trace Packet Generation Across VMX Transitions

In tracing scenarios that collect packets for both VMX root operation and VMX non-root operation, a host executive can manage the MSRs associated with trace packet generation directly. The states of these MSRs need not be modified across VMX transitions.

For tracing scenarios that collect packets only within VMX root operation or only within VMX non-root operation, the VMM can toggle IA32_RTIT_CTL.TraceEn on VMX transitions.

33.5.2.1 System-Wide Tracing

When a host or VMM configures Intel PT to collect trace packets of the entire system, it can leave the relevant VMX controls clear to allow VMX-specific packets to provide information across VMX transitions.

The decoder will desire to identify the occurrence of VMX transitions. The packets of interests to a decoder are shown in Table 33-53.

Table 33-53. Packets on VMX Transitions (System-Wide Tracing)

Event	Packets	Enable	Description
VM exit	EVD.VMXR, EVD.VMXQ, CFE.VMEXIT*	EventEn	The CFE identifies the transfer as a VM exit, while the associated EVDs provide the exit reason and exit qualification.
	FUP(GuestIP)	BranchEn or EventEn	The FUP indicates at which point in the guest flow the VM exit occurred. This is important, since VM exit can be an asynchronous event. The IP will match that written into the VMCS.
	PIP(HostCR3, NR=0)		The PIP packet provides the new host CR3 value, as well as indication that the logical processor is entering VMX root operation. This allows the decoder to identify the change of executing context from guest to host and load the appropriate set of binaries to continue decode.
	TIP(HostIP)	BranchEn	The TIP indicates the destination IP, the IP of the first instruction to be executed in VMX root operation. Note, this packet could be preceded by a MODE.Exec packet (Section 33.4.2.8). This is generated only in cases where CS.D or (CS.L & EFER.LMA) change during the transition.
VM entry	CFE.VMENTRY, FUP(CLIP)	EventEn	The CFE identifies the transfer as a VM entry, while the FUP identifies the VMLAUNCH/VMRESUME IP.
	PIP(GuestCR3, NR=1)	BranchEn	The PIP packet provides the new guest CR3 value, as well as indication that the logical processor is entering VMX non-root operation. This allows the decoder to identify the change of executing context from host to guest and load the appropriate set of binaries to continue decode.
	TIP(GuestIP)	BranchEn	The TIP indicates the destination IP, the IP of the first instruction to be executed in VMX non-root operation. This should match the RIP loaded from the VMCS. Note, this packet could be preceded by a MODE.Exec packet (Section 33.4.2.8). This is generated only in cases where CS.D or (CS.L & EFER.LMA) change during the transition.

Since the VMX controls that suppress packet generation are cleared, a VMCS packet will be included in all PSB+ for this usage scenario. Additionally, VMPTRLD will generate such a packet. Thus the decoder can distinguish the execution context of different VMs.

When the host VMM configures a system to collect trace packets in this scenario, it should emulate CPUID to report CPUID.(EAX=07H, ECX=0):EBX[bit 26] as 0 to guests, indicating to guests that Intel PT is not available.

VMX TSC Manipulation

The TSC packets generated while in VMX non-root operation will include any changes resulting from the use of a VMM's use of the TSC offsetting or TSC scaling VMX controls (see Chapter 26, "VMX Non-Root Operation"). In this system-wide usage model, the decoder may need to account for the effect of per-VM adjustments in the TSC packets generated in VMX non-root operation and the absence of TSC adjustments in TSC packets generated in VMX root operation. The VMM can supply this information to the decoder.

33.5.2.2 Guest-Only Tracing

A VMM can configure trace-packet generation while in VMX non-root operation for guests executing normally. This is accomplished by utilizing VMCS controls to manipulate the guest IA32_RTIT_CTL value on VMX transitions. For

older processors that do not support these VMCS controls, a VMM can use the VMX MSR-load areas on VM exits (see Section 25.7.2, “VM-Exit Controls for MSRs”) and VM entries (see Section 25.8.2, “VM-Entry Controls for MSRs”) to limit trace-packet generation to the guest environment.

For this usage, VM entry is programmed to enable trace packet generation, while VM exit is programmed to clear IA32_RTIT_CTL.TraceEn so as to disable trace-packet generation in the host. Further, if it is preferred that the guest packet stream contain no indication that execution was in VMX non-root operation, the VMM should set to 1 all the VMX controls enumerated in Table 33-52.

33.5.2.3 Emulation of Intel PT Traced State

If a VMM emulates an element of processor state by taking a VM exit on reads and/or writes to that piece of state, and the state element impacts Intel PT packet generation or values, it may be incumbent upon the VMM to insert or modify the output trace data.

If a VM exit is taken on a guest write to CR3 (including “MOV CR3” as well as task switches), the PIP packet normally generated on the CR3 write will be missing.

To avoid decoder confusion when the guest trace is decoded, the VMM should emulate the missing PIP by writing it into the guest output buffer. If the guest CR3 value is manipulated, the VMM may also need to manipulate the IA32_RTIT_CR3_MATCH value, in order to ensure the trace behavior matches the guest's expectation.

Similarly, if a VMM emulates the TSC value by taking a VM exit on RDTSC, the TSC packets generated in the trace may mismatch the TSC values returned by the VMM on RDTSC. To ensure that the trace can be properly aligned with software logs based on RDTSC, the VMM should either make corresponding modifications to the TSC packet values in the guest trace, or use mechanisms such as TSC offsetting or TSC scaling in place of exiting.

33.5.2.4 TSC Scaling

When TSC scaling is enabled for a guest using Intel PT, the VMM should ensure that the value of Maximum Non-Turbo Ratio[15:8] in MSR_PLATFORM_INFO (MSR 0CEH) and the TSC/“core crystal clock” ratio (EBX/EAX) in CPUID leaf 15H are set in a manner consistent with the resulting TSC rate that will be visible to the VM. This will allow the decoder to properly apply TSC packets, MTC packets (based on the core crystal clock or ART, whose frequency is indicated by CPUID leaf 15H), and CBR packets (which indicate the ratio of the processor frequency to the Max Non-Turbo frequency). Absent this, or separate indication of the scaling factor, the decoder will be unable to properly track time in the trace. See Section 33.8.3 for details on tracking time within an Intel PT trace.

33.5.2.5 Failed VM Entry

The packets generated by a failed VM entry depend both on the VMCS configuration, as well as on the type of failure. The results to expect are summarized in the table below. Note that packets in *italics* may or may not be generated, depending on implementation choice, and the point of failure.

Table 33-54. Packets on a Failed VM Entry

Usage Model	Entry Configuration	Early Failure (fall through to next IP)	Late Failure (VM exit like)
System-Wide	No use of “Load IA32_RTIT_CTL” entry control or VM-entry MSR-load area	TIP (NextIP)	<i>CFE.VMENTRY, FUP(CLIP) if EventEn=1</i> <i>PIP(Guest CR3, NR=1), TraceEn 0→1 Packets (See Section 33.2.8.3), PIP(HostCR3, NR=0), TIP(HostIP)</i>
VMM Only	“Load IA32_RTIT_CTL” entry control or VM-entry MSR-load area used to clear TraceEn	TIP (NextIP)	<i>TraceEn 0→1 Packets (See Section 33.2.8.3), TIP(HostIP)</i>
VM Only	“Load IA32_RTIT_CTL” entry control or VM-entry MSR-load area used to set TraceEn	None	None

33.5.2.6 VMX Abort

VMX abort conditions take the processor into a shutdown state. On a VM exit that leads to VMX abort, some packets (FUP, PIP) may be generated, but any expected TIP, TIP.PGE, or TIP.PGD may be dropped.

33.6 TRACING AND SMM TRANSFER MONITOR (STM)

The SMM-transfer monitor (STM) is a VMM that operates inside SMM while in VMX root operation. An STM operates in conjunction with an executive monitor. The latter operates outside SMM and in VMX root operation. Transitions from the executive monitor or its VMs to the STM are called SMM VM exits. The STM returns from SMM via a VM entry to the VM in VMX non-root operation or the executive monitor in VMX root operation.

Intel PT supports tracing in an STM similar to tracing support for VMX operation as described above in Section 33.5. As a result, on a SMM VM exit resulting from #SMI, TraceEn is neither saved nor cleared by default. Software can save the state of the trace configuration MSRs and clear TraceEn using the MSR load/save lists.

Within Event Trace, SMM VM exits generate packets indicating both an #SMI and a VM exit. Similarly, VM entries that return from SMM generate packets that indicate both an RSM and a VM entry. SMM VM exits initiated by the VMCALL instruction do not generate any CFE packet, though the subsequent VM entry returning from SMM will generate a CFE.RSM.

33.7 PACKET GENERATION SCENARIOS

The following tables provides examples of packet generation for various operations. The following acronyms are used in the packet examples below:

- CLIP - Current LIP
- NLIP - Next Sequential LIP
- BLIP - Branch Target LIP

Table 33-55 illustrates the packets generated by a series of example operations, assuming that PacketEn (TriggerEn && ContextEn && FilterEn && BranchEn) is set before and after the operation.

Table 33-55. Packet Generation under Different Example Operations

Case	Operation	Details	Packets
1	Normal non-jump operation		None
2	Conditional branch	6th branch in internal TNT buffer	TNT
3	Conditional branch	1 st ..5 th branch in internal TNT buffer	None
4	Near indirect JMP or CALL		TIP(BLIP)
5	Direct near JMP or CALL		None
6	Near RET	Uncompressed	TIP(BLIP)
7	Near RET	Compressed, 6th branch in internal TNT buffer	TNT
8	Far Branch	Assumes no update to CR3, CS.L, or CS.D	TIP(BLIP)
9	Far Branch	Assumes update to CR3	PIP(NewCR3), TIP(BLIP)
10	Far Branch	Assumes update to CR3 and CS.D/CS.L	PIP(NewCR3), MODE.Exec, TIP(BLIP)
11	External Interrupt or NMI	Assumes no update to CR3, CS.D, or CS.L	FUP(NLIP), TIP(BLIP)
12	External Interrupt or NMI	Assumes update to CR3 and CS.D/CS.L	FUP(NLIP), PIP(NewCR3), MODE.Exec, TIP(BLIP)
13	Exception/Fault or Software Interrupt	Assumes no update to CR3, CS.D, or CS.L	FUP(CLIP), TIP(BLIP)
14	MOV to CR3		PIP(NewCR3, NR)

Table 33-55. Packet Generation under Different Example Operations

Case	Operation	Details	Packets
15	VM exit	Assumes system-wide tracing, see Section 33.5.2.1	See Table 33-53
16	VM entry	Assumes system-wide tracing, see Section 33.5.2.1	See Table 33-53
17	ENCLU[EENTER] / ENCLU[ERESUME] / ENCLU[EEXIT] / AEX/EEE	Only debug enclaves allow PacketEn to be set during enclave execution. Assumes no change to CS.L or CS.D.	FUP(CLIP), TIP(BLIP)
18	XBEGIN/XACQUIRE/XEND/XRELEASE	Does not begin/end transactional execution	None
19	XBEGIN/XACQUIRE	Assumes beginning of transactional execution	MODE.TSX(InTX=1, TXAbort=0), FUP(CLIP)
20	XEND/XRELEASE	Completes transaction	MODE.TSX(InTX=0, TXAbort=0), FUP(CLIP)
21	XABORT or Asynchronous Abort	Aborts transactional execution	MODE.TSX(InTX=0, TXAbort=1), FUP(CLIP), TIP(BLIP)
22	INIT	On BSP. Assumes no CR3, CS.D, or CS.L update.	FUP(NLIP), TIP(ResetLIP)
23	INIT	On AP, goes to wait-for-SIPI. Assumes no CR3 update.	FUP(NLIP)
24	SIPI	Assumes no CS.D or CS.L update	TIP.PGE(SIPI.LIP)
25	Wake from state deeper than C0.1, P-state change, or other scenario where timing packets (MTC, CYC) may have ceased.	TSC if TSCEn=1 TMA if TSCEn=MTCEn=1	TSC?, TMA?, CBR
26	UINTR	User interrupt handler entry.	FUP(NLIP)
27	UIRET	Exiting from user interrupt handler.	FUP(NLIP)

Table 33-56 illustrates the packets generated in example scenarios where the operation alters the value of PacketEn. Note that insertion of PSB+ is not included here, though it can be coincident with initial enabling of Intel PT. See Section 33.3.7 for details.

Table 33-56. Packet Generation with Operations That Alter the Value of PacketEn

Case	Operation	PktEn Before	PktEn After	CntxEn After	Details	Packets
1	WRMSR/XRSTORS that changes TraceEn 0 → 1	0	1	0	TSC if TSCEn=1; TMA if TSCEn=MTCEn=1	TSC?, TMA?, CBR, MODE.Exec
2	WRMSR/XRSTORS that changes TraceEn 0 → 1	0	1	1	TSC if TSCEn=1; TMA if TSCEn=MTCEn=1	TSC?, TMA?, CBR, MODE.Exec, TIP.PGE(NLIP)
3	WRMSR that changes TraceEn 1 → 0	1	0	D.C.		FUP(CLIP), TIP.PGD()
4	Taken Branch	1	0	1	Source is in IP filter region. Target is outside IP filter region.	TIP.PGD(BLIP)
5	Taken Branch, Interrupt, EEXIT, etc.	0	1	1	Source is outside IP filter region. Target is in IP filter region.	TIP.PGE(BLIP)
6	Far Branch, Interrupt, EENTER, etc.	1	0	0	Requires change to CPL or CR3, or entry to opt-out enclave.	TIP.PGD()

Table 33-56. Packet Generation with Operations That Alter the Value of PacketEn (Contd.)

Case	Operation	PktEn Before	PktEn After	CntxEn After	Details	Packets
7	Trap-like event (external interrupt, NMI, VM exit/entry, etc.)	1	0	0	Requires change to CPL or CR3.	FUP(NLIP), TIP.PGD()
8	Fault-like event (exception/fault, software interrupt, VM exit/entry, etc.)	1	0	0	Requires change to CPL or CR3.	FUP(CLIP), TIP.PGD()
9	SMI, VM exit/entry	1	0	0	TraceEn is cleared.	FUP(NLIP), TIP.PGD()
10	RSM, VM exit/entry	0	1	1	TraceEn is set.	See Case 2 for packets on enable. FUP/TIP.PGE IP is the BLIP.
11	VM Exit	1	0	0	Assumes guest-only tracing, see Section 33.5.2.2. TraceEn is cleared.	FUP(VMCSg.RIP), TIP.PGD()
12	VM entry	0	1	1	Assumes guest-only tracing, see Section 33.5.2.2. TraceEn is set.	TIP.PGE(VMCSg.RIP)

Table 33-57 illustrates examples of PTWRITE, assuming TriggerEn && PTWEn is true.

Table 33-57. Examples of PTWRITE when TriggerEn && PTWEn is True

Case	Operation	ContextEn	Details	Packets
1	MWAIT/UMWAIT gets fault or VM exit.	D.C.		None. Other trace sources may generate packets on fault or VM exit.
2	MWAIT/UMWAIT requests C0, or monitor not armed, or VMX virtual-interrupt delivery.	D.C.		None.
3	MWAIT/UMWAIT enters C-state deeper than C0.1.	0		PWRE(Cx), EXSTOP
4	MWAIT/UMWAIT enters C-state deeper than C0.1.	1		MWAIT(Cy), PWRE(Cx), EXSTOP(IP), FUP(CLIP)
5	HLT, Triple-fault shutdown, other operation that enters C1.	1		PWRE(C1), EXSTOP(IP), FUP(CLIP)
6	Hardware Duty Cycling (HDC).	1	TSC if TSCEn=1 TMA if TSCEn=MTCEn=1	PWRE(Hw, C6), EXSTOP(IP), FUP(NLIP), TSC?, TMA?, CBR, PWRX(CC6, CC6, 0x8)
7	Wake event during Cx (x > 0).	D.C.	TSC if TSCEn=1 TMA if TSCEn=MTCEn=1	TSC?, TMA?, CBR, PWRX(LCC, DCC, 0x1) Other trace sources may generate packets for the wake operation (e.g., interrupt).

Table 33-58 illustrates examples of Power Event Trace, assuming TriggerEn && PwrEvtEn is true.

Table 33-58. Examples of Power Event Trace when TriggerEn && PwrEvtEn is True

Case	Operation	ContextEn && FilterEn	Details	Packets
1	PTWRITE rm32/64	0		None

Table 33-58. Examples of Power Event Trace when (Contd.)TriggerEn & PwrEvtEn is True

Case	Operation	ContextEn & FilterEn	Details	Packets
2	PTWRITE rm32	1	FUP, PTW.IP=1 if FUPonPTW=1	PTW(IP=1?, 4B, rm32_value), FUP(CLIP)?
3	PTWRITE rm64	1	FUP, PTW.IP=1 if FUPonPTW=1	PTW(IP=1?, 8B, rm64_value), FUP(CLIP)?

Table 33-59 illustrates examples of Event Trace, assuming TriggerEn & ContextEn & EventEn is true. In all cases, other trace sources (e.g., BranchEn), if enabled, may generate additional packets. For details, see the other tables in this section.

Table 33-59. Event Trace Examples when TriggerEn & ContextEn & EventEn is True

Case	Operation	ContextEn Before	ContextEn After	Details	Packets
1	IRET	1	D.C.		CFE.IRET(IP=1), FUP(CLIP)
2	IRET	0	1		CFE(IRET)
3	External interrupt, including NMI	1	D.C.		CFE.INTR(IP=1, Vector), FUP(NLIP)
4	External interrupt, including NMI	1	1	Assumes BranchEn=1, illustrates the shared FUP.	CFE.INTR(IP=0, Vector), FUP(NLIP), TIP(BLIP)
5	SW Interrupt, Exception/Fault other than #PF	1	D.C.		CFE.INTR(IP=1, Vector), FUP(CLIP)
6	Page Fault (#PF)	1	D.C.		EVD.PFA, CFE.INTR(IP=1,14), FUP(CLIP)
7	Page Fault (#PF)	0	D.C.		None
10	SMI	1	D.C.		CFE.SMI(IP=1), FUP(NLIP)
11	RSM, TraceEn restored to 1	D.C.	1		CFE.RSM(IP=0)
12	Entry to Shutdown	1	D.C.		CFE.SHUTDOWN(IP=1), FUP(CLIP)
13	VM exit caused by interrupt, fault, or SMI	1	D.C.	Assumes "Conceal VMX in PT" exit control is 0.	EVD.VMXQ, EVD.VMXR, CFE.VMEXIT_INTR(IP=1, Vector), FUP(VMCSg.LIP)
14	VM exit caused by other than interrupt, fault, or SMI	1	D.C.	Assumes "Conceal VMX in PT" exit control is 0.	EVD.VMXQ, EVD.VMXR, CFE.VMEXIT(IP=1), FUP(VMCSg.LIP)
15	VM exit caused by other than interrupt, fault, or SMI	0	1	Assumes "Conceal VMX in PT" exit control is 0.	CFE.VMEXIT(IP=0)
16	VM entry	1	D.C.	Assumes "Conceal VMX in PT" entry control is 0.	CFE.VMENTRY(IP=1), FUP(VMCSH.LIP)
17	AEX/EEE, from opt-out (non-debug) enclave	0	0		None
18	AEX/EEE, from opt-out (non-debug) enclave	0	1		CFE.INTR(IP=0)
19	AEX, from opt-in (debug) enclave	1	D.C.		CFE.INTR(IP=1, Vec), FUP(AEP LIP)
20	INIT	1	D.C.		CFE.INIT(IP=1), FUP(NLIP)
21	SIPI	1	D.C.		CFE.SIPI(IP=0)

Table 33-59. Event Trace Examples when TriggerEn && ContextEn && EventEn is True

Case	Operation	ContextEn Before	ContextEn After	Details	Packets
22	STI/CLI/POPF	1	1	Assumes a change to RFLAGS.IF.	MODE.Exec, FUP(CLIP)

33.8 SOFTWARE CONSIDERATIONS

33.8.1 Tracing SMM Code

Nothing prevents an SMM handler from configuring and enabling packet generation for its own use. As described in Section Section 33.2.9.3, SMI will always clear TraceEn, so the SMM handler would have to set TraceEn in order to enable tracing. There are some unique aspects and guidelines involved with tracing SMM code, which follow:

1. SMM should save away the existing values of any configuration MSR that SMM intends to modify for tracing. This will allow the non-SMM tracing context to be restored before RSM.
2. It is recommended that SMM wait until it sets CSbase to 0 before enabling packet generation, to avoid possible LIP vs RIP confusion.
3. Packet output cannot be directed to SMRR memory, even while tracing in SMM.
4. Before performing RSM, SMM should take care to restore modified configuration MSRs to the values they had immediately after #SMI. This involves first disabling packet generation by clearing TraceEn, then restoring any other configuration MSRs that were modified.
5. RSM
 - Software must ensure that TraceEn=0 at the time of RSM. Tracing RSM is not a supported usage model, and the packets generated by RSM are undefined.
 - For processors on which Intel PT and LBR use are mutually exclusive (see Section 33.3.1.2), any RSM during which TraceEn is restored to 1 will suspend any LBR or BTS logging.

33.8.2 Cooperative Transition of Multiple Trace Collection Agents

A third-party trace-collection tool should take into consideration the fact that it may be deployed on a processor that supports Intel PT but may run under any operating system.

In such a deployment scenario, Intel recommends that tool agents follow similar principles of cooperative transition of single-use hardware resources, similar to how performance monitoring tools handle performance monitoring hardware:

- Respect the “in-use” ownership of an agent who already configured the trace configuration MSRs, see architectural MSRs with the prefix “IA32_RTIT_” in Chapter 2, “Model-Specific Registers (MSRs),” in the Intel® 64 and IA-32 Architectures Software Developer’s Manual, Volume 4, where “in-use” can be determined by reading the “enable bits” in the configuration MSRs.
- Relinquish ownership of the trace configuration MSRs by clearing the “enabled bits” of those configuration MSRs.

33.8.3 Tracking Time

This section describes the relationships of several clock counters whose update frequencies reside in different domains that feed into the timing packets. To track time, the decoder also needs to know the regularity or irregularity of the occurrences of various timing packets that store those clock counters.

Intel PT provides time information for three different but related domains:

- Processor timestamp counter

This counter increments at the max non-turbo or P1 frequency, and its value is returned on a RDTSC. Its frequency is fixed. The TSC packet holds the lower 7 bytes of the timestamp counter value. The TSC packet occurs occasionally and are much less frequent than the frequency of the time stamp counter. The timestamp counter will continue to increment when the processor is in deep C-States, with the exception of processors reporting CPUID.80000007H:EDX.InvariantTSC[bit 8] =0.

- Core crystal clock

The ratio of the core crystal clock to timestamp counter frequency is known as P, and can be calculated as CPUID.15H:EBX[31:0] / CPUID.15H:EAX[31:0]. The frequency of the core crystal clock is fixed and lower than that of the timestamp counter. The periodic MTC packet is generated based on software-selected multiples of the crystal clock frequency. The MTC packet is expected to occur more frequently than the TSC packet.

- Processor core clock

The processor core clock frequency can vary due to P-state and thermal conditions. The CYC packet provides elapsed time as measured in processor core clock cycles relative to the last CYC packet.

A decoder can use all or some combination of these packets to track time at different resolutions throughout the trace packets.

33.8.3.1 Time Domain Relationships

The three domains are related by the following formula:

$$\text{TimeStampValue} = (\text{CoreCrystalClockValue} * P) + \text{AdjustedProcessorCycles} + \text{Software_Offset};$$

The CoreCrystalClockValue, also known as the Always Running Timer (ART) value, can provide the coarse-grained component of the TSC value. P, or the TSC/ART ratio, can be derived from CPUID leaf 15H, as described in Section 33.8.3.

The AdjustedProcessorCycles component provides the fine-grained distance from the rising edge of the last core crystal clock. Specifically, it is a cycle count in the same frequency as the timestamp counter from the last crystal clock rising edge. The value is adjusted based on the ratio of the processor core clock frequency to the Maximum Non-Turbo (or P1) frequency.

The Software_Offsets component includes software offsets that are factored into the timestamp value, such as IA32_TSC_ADJUST.

33.8.3.2 Estimating TSC within Intel PT

For many usages, it may be useful to have an estimated timestamp value for all points in the trace. The formula provided in Section 33.8.3.1 above provides the framework for how such an estimate can be calculated from the various timing packets present in the trace.

The TSC packet provides the precise timestamp value at the time it is generated; however, TSC packets are infrequent, and estimates of the current timestamp value based purely on TSC packets are likely to be very inaccurate for this reason. In order to get more precise timing information between TSC packets, CYC packets and/or MTC packets should be enabled.

MTC packets provide incremental updates of the CoreCrystalClockValue. On processors that support CPUID leaf 15H, the frequency of the timestamp counter and the core crystal clock is fixed, thus MTC packets provide a means to update the running timestamp estimate. Between two MTC packets A and B, the number of crystal clock cycles passed is calculated from the 8-bit payloads of respective MTC packets:

$$(\text{CTC}_B - \text{CTC}_A), \text{ where } \text{CTC}_i = \text{MTC}_i[15:8] \ll \text{IA32_RTIT_CTL.MTCFreq} \text{ and } i = A, B.$$

The time from a TSC packet to the subsequent MTC packet can be calculated using the TMA packet that follows the TSC packet. The TMA packet provides both the crystal clock value (lower 16 bits, in the CTC field) and the AdjustedProcessorCycles value (in the FastCounter field) that can be used in the calculation of the corresponding core crystal clock value of the TSC packet.

When the next MTC after a pair of TSC/TMA is seen, the number of crystal clocks passed since the TSC packet can be calculated by subtracting the TMA.CTC value from the time indicated by the MTC_{Next} packet by

$$\text{CTC}_{\text{Delta}}[15:0] = (\text{CTC}_{\text{Next}}[15:0] - \text{TMA.CTC}[15:0]), \text{ where } \text{CTC}_{\text{Next}} = \text{MTC}_{\text{Payload}} \ll \text{IA32_RTIT_CTL.MTCFreq}.$$

The TMA.FastCounter field provides the number of AdjustedProcessorCycles since the last crystal clock rising edge, from which it can be determined the percentage of the next crystal clock cycle that had passed at the time of the TSC packet.

CYC packets can provide further precision of an estimated timestamp value to many non-timing packets, by providing an indication of the time passed between other timing packets (MTCs or TSCs).

When enabled, CYC packets are sent preceding each CYC-eligible packet, and provide the number of processor core clock cycles that have passed since the last CYC packet. Thus between MTCs and TSCs, the accumulated CYC values can be used to estimate the AdjustedProcessorCycles component of the timestamp value. The accumulated CPU cycles will have to be adjusted to account for the difference in frequency between the processor core clock and the P1 frequency. The necessary adjustment can be estimated using the core:bus ratio value given in the CBR packet, by multiplying the accumulated cycle count value by $P1/CBR_{payload}$.

Note that stand-alone TSC packets (that is, TSC packets that are not a part of a PSB+) are typically generated only when generation of other timing packets (MTCs and CYCs) has ceased for a period of time. Example scenarios include when Intel PT is re-enabled, or on wake after a sleep state. Thus any calculated estimate of the timestamp value leading up to a TSC packet will likely result in a discrepancy, which the TSC packet serves to correct.

A greater level of precision may be achieved by calculating the CPU clock frequency, see Section 33.8.3.4 below for a method to do so using Intel PT packets.

CYCs can be used to estimate time between TSCs even without MTCs, though this will likely result in a reduction in estimated TSC precision.

33.8.3.3 VMX TSC Manipulation

When software executes in non-Root operation, additional offset and scaling factors may be applied to the TSC value. These are optional, but may be enabled via VMCS controls on a per-VM basis. See Chapter 26, “VMX Non-Root Operation,” for details on VMX TSC offsetting and TSC scaling.

Like the value returned by RDTSC, TSC packets will include these adjustments, but other timing packets (such as MTC, CYC, and CBR) are not impacted. In order to use the algorithm above to estimate the TSC value when TSC scaling is in use, it will be necessary for software to account for the scaling factor. See Section 33.5.2.4 for details.

33.8.3.4 Calculating Frequency with Intel PT

Because Intel PT can provide both wall-clock time and processor clock cycle time, it can be used to measure the processor core clock frequency. Either TSC or MTC packets can be used to track the wall-clock time. By using CYC packets to count the number of processor core cycles that pass in between a pair of wall-clock time packets, the ratio between processor core clock frequency and TSC frequency can be derived. If the P1 frequency is known, it can be applied to determine the CPU frequency. See Section 33.8.3.1 above for details on the relationship between TSC, MTC, and CYC.

