

# **Intel® Server System R1000WT Family**

# **Intel® Storage System R1000WT Family**

## ***Technical Product Specification***

A document providing an overview of product features, functions, architecture, and support specifications

Revision 1.08

March 2020

Intel® Server Boards and Systems

<Blank Page>



## Revision History

Date	Revision Number	Modifications
September 2014	1.0	First External Public Release
November 2014	1.01	<ul style="list-style-type: none"> <li>• Added packaging specs and system weight data</li> <li>• Added DIMM Slot population requirements to maintain system thermals in Section 4.1</li> <li>• Added section 5.2 System Fan RVI and Hard Disk Drive Storage Performance</li> <li>• Updated PCIe* SFF SSD (NVMe) feature support</li> <li>• Added support for dual RMFBU accessory kit</li> <li>• Updated System Status LED State Definition table</li> <li>• Added missing cable routing diagram in Appendix E</li> <li>• Updated Thermal Config Table data</li> </ul>
December 2014	1.02	<ul style="list-style-type: none"> <li>• Updated Section 4.1 – Add-in card support requirements</li> <li>• Updated PCIe* SFF SSD (NVMe) feature support</li> <li>• Added Appendix F – Statement of Volatility</li> </ul>
May 2015	1.03	<ul style="list-style-type: none"> <li>• Update document Legal Disclaimer statements</li> <li>• Chapter 2 – added OS Support list and defined OS validation test levels and technical support levels</li> <li>• Section 2.12.1 - Updated product weight information</li> <li>• Section 5.6.5 - Updated 8 x 2.5" Drive Combo SAS / PCIe* SFF (NVMe) SSD Backplane Accessory Kit</li> </ul>
March 2016	1.04	<ul style="list-style-type: none"> <li>• Updated to include "R" in product SKU names.</li> <li>• Updated Rail kits.</li> <li>• Updated to include Intel® Storage Server R1000WT family</li> </ul>
November 2016	1.06	<ul style="list-style-type: none"> <li>• Appendix F – Added the SOV for 750W power supply module</li> </ul>
February 2020	1.07	<ul style="list-style-type: none"> <li>• Added Appendix H – Product Regulatory Information, including product collateral links in support of EU Lot 9 collateral efficiency requirements</li> </ul>
March 2020	1.08	<ul style="list-style-type: none"> <li>• Added EU LOT Support Summary tables to Appendix H</li> </ul>

## ***Disclaimers***

Intel technologies' features and benefits depend on system configuration and may require enabled hardware, software or service activation. Learn more at Intel.com, or from the OEM or retailer.

You may not use or facilitate the use of this document in connection with any infringement or other legal analysis concerning Intel products described herein. You agree to grant Intel a non-exclusive, royalty-free license to any patent claim thereafter drafted which includes subject matter disclosed herein.

No license (express or implied, by estoppel or otherwise) to any intellectual property rights is granted by this document.

The products described may contain design defects or errors known as errata which may cause the product to deviate from published specifications. Current characterized errata are available on request.

Intel disclaims all express and implied warranties, including without limitation, the implied warranties of merchantability, fitness for a particular purpose, and non-infringement, as well as any warranty arising from course of performance, course of dealing, or usage in trade.

Intel, the Intel logo, Xeon, and Xeon Phi are trademarks of Intel Corporation in the U.S. and/or other countries.

\*Other names and brands may be claimed as the property of others.

Copyright © 2016 Intel Corporation. All Rights Reserved.

## Table of Contents

<b>1. Introduction</b>	<b>10</b>
1.1 Chapter Outline	10
1.2 Server Board Use Disclaimer	11
1.3 Product Errata	11
<b>2. Product Family Overview</b>	<b>12</b>
2.1 Operating System Support	14
2.1.1 OS Validation Levels	15
2.1.2 OS Technical Support Levels	16
2.2 System Features Overview	17
2.3 Server Board Features Overview	18
2.4 Back Panel Features	21
2.5 Front Control Panel	21
2.6 Front Drive Bay Options	21
2.7 Locking Front Bezel	22
2.8 System Dimensions	24
2.8.1 Chassis Dimensions	24
2.8.2 Label Emboss Dimensions	25
2.8.3 Pull-out Tab Label Emboss Dimensions	26
2.9 System Cable Routing Channels	27
2.10 Available Rack and Cabinet Mounting Kit Options	28
2.11 System Level Environmental Limits	29
2.12 System Packaging	30
2.12.1 Intel Product Weight Information	30
<b>3. System Power</b>	<b>31</b>
3.1 Power Supply Configurations	31
3.2 Power Supply Module Options	32
3.2.1 Power Supply Module Efficiency	32
3.2.2 Power Supply Module Mechanical Overview	32
3.2.3 Power Cord Specification Requirements	33
3.3 AC Power Supply Input Specifications	34
3.3.1 Power Factor	34
3.3.2 AC Input Voltage Specification	34
3.3.3 AC Line Isolation Requirements	35
3.3.4 AC Line Dropout / Holdup	35
3.3.5 AC Line Fuse	35
3.3.6 AC Inrush	35
3.3.7 AC Line Transient Specification	35
3.3.8 Susceptibility Requirements	36
3.3.9 Electrostatic Discharge Susceptibility	36
3.3.10 Fast Transient/Burst	36

3.3.11	Radiated Immunity .....	36
3.3.12	Surge Immunity .....	36
3.3.13	Power Recovery .....	37
3.3.14	Voltage Interruptions .....	37
3.3.15	Protection Circuits .....	37
3.3.16	Power Supply Status LED .....	38
3.4	DC Power Supply Input Specifications .....	38
3.4.1	DC Input Voltage .....	38
3.4.2	DC Input Fuse .....	38
3.4.3	DC Inrush Current .....	39
3.4.4	DC Input Under Voltage .....	39
3.4.5	DC Holdup Time and Dropout .....	39
3.4.6	DC Line Surge Voltages (Line Transients) .....	39
3.4.7	Susceptibility Requirements .....	39
3.4.8	Protection Circuits .....	40
3.5	Cold Redundancy Support .....	41
3.5.1	Powering on Cold Standby supplies to maintain best efficiency .....	42
3.5.2	Powering on Cold Standby Supplies during a Fault or Over Current Condition .....	42
3.5.3	BMC Requirements .....	42
3.5.4	Power Supply Turn On Function .....	42
3.6	Closed Loop System Throttling (CLST) .....	43
3.7	Smart Ride Through (SmaRT) .....	43
3.8	Server Board Power Connectors .....	43
3.8.1	Power Supply Module Card Edge Connector .....	43
3.8.2	Hot Swap Backplane Power Connector .....	44
3.8.3	Optical Drive and SSD Power Connector .....	44
<b>4.</b>	<b>Thermal Management .....</b>	<b>45</b>
4.1	Thermal Operation and Configuration Requirements .....	46
4.2	Thermal Management Overview .....	47
4.2.1	Fan Speed Control .....	48
4.3	System Fans .....	51
4.4	Power Supply Module Fans .....	53
4.5	FRUSDR Utility .....	53
<b>5.</b>	<b>System Storage and Peripheral Drive Bay Overview .....</b>	<b>55</b>
5.1	Front Mount Drive Support .....	55
5.2	System Fan RVI and Hard Disk Drive Storage Performance .....	56
5.3	Hot Swap Storage Device Carriers .....	57
5.4	Peripheral Power Sources .....	59
5.5	Optical Drive Support .....	60
5.6	Storage Backplane Options .....	61
5.6.1	SGPIO Functionality .....	62
5.6.2	I2C Functionality .....	62

5.6.3	4 x 3.5" Drive Hot-Swap Backplane Overview.....	62
5.6.4	8 x 2.5" Drive SAS Backplane .....	63
5.6.5	8 x 2.5" Drive Combo SAS / PCIe* SFF (NVMe) SSD Backplane Accessory Kit.....	65
5.7	Low Profile eUSB SSD Support.....	71
5.8	SATA DOM Support .....	72
<b>6.</b>	<b>Storage Controller Options Overview .....</b>	<b>74</b>
6.1	Embedded SATA/SATA RAID Support .....	74
6.1.1	Staggered Disk Spin-Up .....	76
6.2	Embedded SATA SW-RAID support .....	76
6.2.1	Intel® Rapid Storage Technology (RSTe) 4.1 .....	76
6.2.2	Intel® Embedded Server RAID Technology 2 (ESRT2) 1.41.....	77
6.3	Intel® Integrated RAID Module Support.....	79
6.3.1	Intel® RAID Maintenance Free Backup Unit (RMFBU) Support .....	79
<b>7.</b>	<b>Front Control Panel and I/O Panel Overview.....</b>	<b>81</b>
7.1	I/O Panel Features .....	81
7.2	Control Panel Features .....	82
<b>8.</b>	<b>Intel® Local Control Panel.....</b>	<b>86</b>
<b>9.</b>	<b>PCIe* Riser Card Support.....</b>	<b>87</b>
<b>10.</b>	<b>Intel® I/O Module Support.....</b>	<b>89</b>
<b>11.</b>	<b>Basic and Advanced Server Management Features .....</b>	<b>90</b>
11.1.1	Dedicated Management Port .....	91
11.1.2	Embedded Web Server.....	91
11.1.3	Advanced Management Feature Support (RMM4 Lite).....	93
<b>Appendix A: Integration and Usage Tips.....</b>		<b>97</b>
<b>Appendix B: POST Code Diagnostic LED Decoder .....</b>		<b>98</b>
<b>Appendix C: POST Code Errors.....</b>		<b>101</b>
<b>Appendix D: System Configuration Table for Thermal Compatibility.....</b>		<b>108</b>
<b>Appendix E: System Cable Routing Diagrams.....</b>		<b>113</b>
<b>Appendix F: Statement of Volatility .....</b>		<b>115</b>
<b>Appendix G: Intel® Storage System R1000WT .....</b>		<b>118</b>
<b>Appendix H: Product Regulatory Information.....</b>		<b>122</b>
<b>Glossary .....</b>		<b>127</b>
<b>Reference Documents .....</b>		<b>129</b>



## List of Figures

Figure 1. System Components Overview .....	17
Figure 2. Top Cover Features .....	17
Figure 3. Server Board Features.....	18
Figure 4. On-board Light Guided Diagnostics.....	19
Figure 5. DIMM Fault LEDs.....	20
Figure 6. System Reset and Configuration Jumpers .....	20
Figure 7. Back Panel Feature Identification.....	21
Figure 8. Front Control Panel Options .....	21
Figure 9. 3.5" Drive Bay – 4 Drive Configuration (Model R1304WTxxxxx).....	21
Figure 10. 2.5" Drive Bay – 8 Drive Configuration (Model R1208WTxxxxx).....	21
Figure 11. Front Bezel .....	22
Figure 12. Front Bezel accessory with optionally installed wave feature.....	22
Figure 13. Front Bezel accessory with optionally installed wave and ID badge (1) .....	22
Figure 14. Front Bezel accessory with optionally installed wave and ID badge (2) .....	23
Figure 15. Front Bezel accessory ID Badge mechanical drawings.....	23
Figure 16. Chassis Dimensions .....	24
Figure 17. Label Emboss Dimensions.....	25
Figure 18. Pull-out Tab Label Emboss Dimensions.....	26
Figure 19. System Cable Routing Channels .....	27
Figure 20. 750W AC Power Supply.....	31
Figure 21. Power Supply Module Overview.....	32
Figure 22. 750W AC Power Supply Module Mechanical Drawing .....	33
Figure 23. AC Power Cord.....	33
Figure 24. DC Power Cord Specification.....	34
Figure 25. System Air Flow and Fan Identification.....	45
Figure 26. Fan Control Model .....	51
Figure 27. System Fan Assembly.....	52
Figure 28. System Fan Connector Locations on Server Board .....	52
Figure 29. 8x2.5" Drive Bay Configuration (Model R1208xxxxx).....	55
Figure 30. 4x3.5" Drive Bay Configuration (Model R1304WTxxxx) .....	56
Figure 31. 2.5" SSD mounted to 3.5" Drive Tray .....	57
Figure 32. Drive Tray LED Identification .....	58
Figure 33. Server Board Peripheral Power Connectors .....	59
Figure 34. Optical Drive Support.....	60
Figure 35. Optical Drive Installation.....	60
Figure 36. Backplane Installation .....	61
Figure 37. 4 x 3.5" Drive Hot-Swap Backplane – front view .....	62
Figure 38. 4 x 3.5" Drive Hot-Swap Backplane – rear view .....	63
Figure 39. 8 x 2.5" Drive SAS/SATA Backplane – front view .....	63

Figure 40. 8 x 2.5" Drive SAS/SATA Backplane – rear view .....	64
Figure 41. Combo Backplane Kit Device Carrier Identification .....	65
Figure 42. 8 x 2.5" Combo SAS / PCIe* SFF (NVMe) Backplane – Front View .....	66
Figure 43. Combo Backplane Rear Connector Identification.....	67
Figure 44. Combo Backplane Cable Routing – PCIe* SFF (NVMe) + SAS.....	68
Figure 45. Combo Backplane Cable Routing – PCIe* SFF (NVMe) + SATA.....	69
Figure 46. Low Profile eUSB SSD Support .....	71
Figure 47. On-board SATA Features.....	74
Figure 48. SATA RAID 5 Upgrade Key.....	78
Figure 49. Intel® Integrated RAID Module.....	79
Figure 50. Support for single Intel® RAID Maintenance Free Backup Unit (Standard Option) .....	79
Figure 51. Support for dual Intel® RAID Maintenance Free Backup Units (Optional Accessory).....	80
Figure 52. Front I/O Panel Features .....	81
Figure 53. Front Control Panel Options.....	82
Figure 54. Intel Local Control Panel Option.....	86
Figure 55. Add-in Card Support.....	88
Figure 56. Riser Card Assembly.....	88
Figure 57. Intel® I/O Module Placement .....	89
Figure 58. Intel® RMM4 Lite Activation Key Installation.....	91
Figure 59. POST Diagnostic LED Location .....	98
Figure 60. Intel® Storage Server R1000WT .....	118

## List of Tables

Table 1. Intel® Server System R1000WT Product Family Feature Set .....	12
Table 2. Operating System Support List .....	14
Table 3. Operating System Validation Levels .....	15
Table 4. System Environmental Limits Summary.....	29
Table 5. 750 Watt AC Power Supply Efficiency (Platinum).....	32
Table 6. 750 Watt DC Power Supply Efficiency (Gold).....	32
Table 7. AC Power Cord Specifications.....	33
Table 8. DC Power Cable Connector Pin-out .....	34
Table 9. AC Input Voltage Range – 750W Power Supply .....	34
Table 10. AC Line Holdup Time – 750W Power Supply.....	35
Table 11. AC Line Sag Transient Performance .....	36
Table 12. AC Line Surge Transient Performance.....	36
Table 13. Performance Criteria .....	36
Table 14. Over Current Protection – 750 Watt Power Supply.....	37
Table 15. Over Voltage Protection (OVP) Limits – 750W Power Supply.....	37
Table 16. LED Indicators .....	38
Table 17. DC Input Rating.....	38
Table 18. Line Voltage Transient Limits .....	39
Table 19. Over Current Protection – 750 Watt Power Supply .....	41
Table 20. Over Voltage Protection Limits – 750 Watt Power Supply .....	41
Table 21. Example Load Share Threshold for Activating Supplies.....	42
Table 22. Power Supply Module Output Power Connector Pin-out .....	43
Table 23. Hot Swap Backplane Power Connector Pin-out (“HSBP PWR”) .....	44
Table 24. Peripheral Drive Power Connector Pin-out (“Peripheral PWR”).....	44
Table 25. System Volumetric Air Flow .....	45
Table 26. System Fan Connector Pin-out.....	53
Table 27. Drive Status LED States.....	58
Table 28. Drive Activity LED States.....	58
Table 29. Intel® Accessory Kit A2U44X25NVMEK Operating System Support List.....	70
Table 30. SATA and sSATA Controller Feature Support.....	75
Table 31. SATA and sSATA Controller BIOS Utility Setup Options .....	75
Table 32. System Status LED State Definitions.....	83
Table 33. Power/Sleep LED Functional States .....	85
Table 34. Riser Slot #1 – Riser Card Options.....	87
Table 35. Riser Slot #2 – Riser Card Options.....	87
Table 36. Supported Intel® I/O Modules .....	89
Table 37. Intel® Remote Management Module 4 (RMM4) Options.....	90
Table 38. Basic and Advanced Server Management Features Overview.....	90
Table 39. POST Progress Code LED Example.....	98

Table 40. MRC Progress Codes .....	99
Table 41. MRC Fatal Error Codes.....	100
Table 42. POST Error Messages and Handling.....	101
Table 43. POST Error Beep Codes.....	106
Table 44. Integrated BMC Beep Codes .....	107
Table 45. Intel® Storage System R1000WT Feature List.....	119

# 1. Introduction

---

This Technical Product Specification (TPS) provides system level information for the Intel® Server System R1000WT product family.

This document describes the embedded functionality and available features of the integrated server system which includes: the chassis layout, system boards, power subsystem, cooling subsystem, storage subsystem options, and available installable options. Note that some system features are provided as configurable options and may not be included standard in every system configuration offered. Please reference *the Intel® Server Board S2600WT Product Family Configuration Guide* for a list of configured options for all system SKUs made available.

Server board specific detail can be obtained by referencing the *Intel® Server Board S2600WT Technical Product Specification*.

In addition, design-level information related to specific server board components/subsystems can be obtained by ordering External Product Specifications (EPS) or External Design Specifications (EDS) related to this server generation. EPS and EDS documents are made available under NDA with Intel and must be ordered through your local Intel representative. See the Reference Documents section at the end of this document for a list of available documents.

## 1.1 Chapter Outline

This document is divided into the following chapters:

- Chapter 1 – Introduction
- Chapter 2 – Product Family Overview
- Chapter 3 – System Power
- Chapter 4 – Thermal Management
- Chapter 5 – System Storage and Peripherals Drive Bay Overview
- Chapter 6 – Storage Controller Options Overview
- Chapter 7 – Front Control Panel and I/O Panel Overview
- Chapter 8 – Intel® Local Control Panel
- Chapter 9 – PCIe\* Riser Card Support
- Chapter 10 – Intel® I/O Module Support
- Chapter 11 – Basic and Advanced Server Management Features
- Appendix A – Integration and Usage Tips
- Appendix B – POST Code Diagnostic LED Decoder
- Appendix C – Post Code Errors
- Appendix D – System Configuration Tables for Thermal Compatibility
- Appendix E – System Cable Routing Diagrams
- Appendix F – Statement of Volatility
- Appendix G – Intel® Storage System R1000WT Family Overview
- Glossary
- Reference Documents

## 1.2 Server Board Use Disclaimer

Intel Corporation server boards support add-in peripherals and contain a number of high-density VLSI and power delivery components that need adequate airflow to cool. Intel ensures through its own chassis development and testing that when Intel server building blocks are used together, the fully integrated system will meet the intended thermal requirements of these components. It is the responsibility of the system integrator who chooses not to use Intel-developed server building blocks to consult vendor datasheets and operating parameters to determine the amount of airflow required for their specific application and environmental conditions. Intel Corporation cannot be held responsible if components fail or the server board does not operate correctly when used outside any of their published operating or non-operating limits.

## 1.3 Product Errata

Shipping product may have features or functionality that may deviate from published specifications. These deviations are generally discovered after the product has gone into formal production. Intel terms these deviations as product Errata. Known product Errata will be published in the Monthly Specification Update for the given product family which can be downloaded from the following Intel web site:

<http://www.intel.com/support>

## 2. Product Family Overview

This generation of Intel 1U server platforms offers a variety of system options to meet the varied configuration requirements of high-density high-performance computing environments. The Intel® Server System R1000WT product family includes several available 1U rack mount server systems. Each building block option or L6 integrated system within this product family is configured around the following Intel server board: Intel® Server Board S2600WT.

This chapter provides a high-level overview of the system features and available options as supported in different system models within this product family. Greater detail for each major sub-system, feature, or option is provided in the following chapters.

Note: Product information specific to the Intel® Storage System R1000WT family can be found in Appendix G of this document.

**Table 1. Intel® Server System R1000WT Product Family Feature Set**

Feature	Description
Chassis Type	1U Rack Mount Chassis
Server Board	<ul style="list-style-type: none"> <li>▪ Intel® Server Board S2600WT w/Dual 1GbE ports – (Intel product code - <b>S2600WT2R</b>)</li> <li>▪ Intel® Server Board S2600WT w/Dual 10GbE ports – (Intel product code - <b>S2600WTTR</b>)</li> </ul>
Processor Support	<ul style="list-style-type: none"> <li>▪ Two LGA2011-3 (Socket R3) processor sockets</li> <li>▪ Support for one or two Intel® Xeon® processors E5-2600 v3 and v4 product family</li> <li>▪ Maximum supported Thermal Design Power (TDP) of up to 145 W.</li> </ul>
Memory	<ul style="list-style-type: none"> <li>▪ 24 DIMM slots – 3 DIMMs/Channel – 4 memory channels per processor</li> <li>▪ Registered DDR4 (RDIMM), Load Reduced DDR4 (LRDIMM)</li> <li>▪ Memory data transfer rates: <ul style="list-style-type: none"> <li>○ DDR4 RDIMM: 1600 MT/s (3DPC), 1866 MT/s (2DPC), 2133 MT/s (2DPC) and 2400 MT/s (1DPC)</li> <li>○ DDR4 LRDIMM: 1866 Mt/s (3DPC), 2400 MT/s (2DPC)</li> <li>○ DDR4 LRDIMM3DS: 1866 Mt/s (3DPC), 2400 MT/s (2DPC)</li> <li>○ NVDIMM: 2133 Mt/s (1DPC)</li> </ul> </li> <li>▪ DDR4 standard I/O voltage of 1.2V</li> </ul>
Chipset	Intel® C612 chipset
External I/O connections	<ul style="list-style-type: none"> <li>▪ DB-15 Video connectors <ul style="list-style-type: none"> <li>○ Front and Back</li> </ul> </li> <li>▪ RJ-45 Serial Port A connector</li> <li>▪ Dual RJ-45 Network Interface connectors supporting either : <ul style="list-style-type: none"> <li>○ 10 GbE RJ-45 connectors (Intel Server Board Product Code – S2600WTTR)</li> <li>or</li> <li>○ 1 GbE RJ-45 connectors (Intel Server Board Product Code – S2600WT2R)</li> </ul> </li> <li>▪ Dedicated RJ-45 server management NIC</li> <li>▪ Three USB 2.0 / 3.0 connectors on back panel</li> <li>▪ Two USB 2.0 / 3.0 connectors on front panel</li> </ul>

## Intel® Server System R1000WT Family TPS

Feature	Description
Internal I/O connectors / headers	<ul style="list-style-type: none"> <li>▪ One Type-A USB 2.0 connector</li> <li>▪ One 2x5 pin connector providing front panel support for two USB 2.0 ports</li> <li>▪ One 2x10 pin connector providing front panel support for two USB 2.0 / 3.0 ports</li> <li>▪ One 2x15 pin SSI-EEB compliant front panel header</li> <li>▪ One 2x7pin Front Panel Video connector</li> <li>▪ One 1x7pin header for optional Intel® Local Control Panel (LCP) support</li> <li>▪ One DH-10 Serial Port B connector</li> </ul>
Intel® I/O Module Accessory Options	<p>The server board includes a proprietary on-board connector allowing for the installation of a variety of available Intel® I/O modules. An installed I/O module can be supported in addition to standard on-board features and add-in PCIe cards.</p> <ul style="list-style-type: none"> <li>▪ AXX4P1GBPWL IOM – Quad port RJ45 1 GbE based on Intel® Ethernet Controller I350</li> <li>▪ AXX10GBTWL IOM3 – Dual port RJ-45 10GBase-T based on Intel® Ethernet Controller x540</li> <li>▪ AXX10GBNIA IOM – Dual port SFP+ 10 GbE module based on Intel® 82599 10 GbE controller</li> <li>▪ AXX1FDRIB IOM – Single port QSFP FDR 56 GT/S speed InfiniBand* module</li> <li>▪ AXX2FDRIB IOM – Dual port QSFP FDR 56 GT/S speed infiniband* module</li> <li>▪ AXX1P40FRT IOM – Single port QSFP+ 40 GbE module</li> <li>▪ AXX2P40FRT IOM – Dual port QSFP+ 40 GbE module</li> </ul>
System Fans	<ul style="list-style-type: none"> <li>▪ Six managed 40mm dual rotor system fans</li> <li>▪ One power supply fan for each installed power supply module</li> </ul>
Riser Card Support	<p>Support for two riser cards:</p> <ul style="list-style-type: none"> <li>▪ Riser #1 – PCIe* Gen3 x24 – 1 PCIe slot</li> <li>▪ Riser #2 – PCIe* Gen3 x24 – 1 PCIe slot</li> </ul> <p>With two riser cards installed, up to 2 possible add-in cards can be supported:</p> <ul style="list-style-type: none"> <li>▪ 2 Full Height / Half Length add-in cards via Risers #1 and #2</li> </ul>
Video	<ul style="list-style-type: none"> <li>▪ Integrated 2D Video Controller</li> <li>▪ 16 MB DDR3 Memory</li> </ul>
On-board storage controllers and options	<ul style="list-style-type: none"> <li>▪ 10 x SATA 6Gbps ports (6Gb/s, 3 Gb/s and 1.5Gb/s transfer rates are supported) <ul style="list-style-type: none"> <li>○ Two single port SATA connectors capable of supporting up to 6 Gb/sec</li> <li>○ Two 4-port mini-SAS HD (SFF-8643) connectors capable of supporting up to 6 Gb/sec /SATA</li> </ul> </li> <li>▪ One eUSB 2x5 pin connector to support 2mm low-profile eUSB solid state devices</li> <li>▪ Optional SAS IOC/ROC support via on-board Intel® Integrated RAID module connector</li> <li>▪ Embedded Software SATA RAID <ul style="list-style-type: none"> <li>○ Intel® Rapid Storage RAID Technology (RSTe) 4.1</li> <li>○ Intel® Embedded Server RAID Technology 2 (ESRT2) 1.41 with optional RAID 5 key support</li> </ul> </li> </ul>
Security	<ul style="list-style-type: none"> <li>▪ Intel® Trusted Platform Module (TPM) - AXXTPE5 (1.2), AXXTPE6 (v2.0) and AXXTPE7 (v2.0) (Accessory Option)</li> </ul>
Server Management	<ul style="list-style-type: none"> <li>▪ Integrated Baseboard Management Controller, IPMI 2.0 compliant</li> <li>▪ Support for Intel® Server Management Software</li> <li>▪ On-board RJ45 management port</li> <li>▪ Advanced Server Management via an Intel® Remote Management Module 4 Lite (Accessory Option)</li> </ul>
Power Supply Options	<ul style="list-style-type: none"> <li>▪ The server system can have up to two power supply modules installed, providing support for the following power configurations: 1+0, 1+1 Redundant Power, and 2+0 Combined Power</li> <li>▪ Two power supply options: <ul style="list-style-type: none"> <li>○ AC 750W Platinum</li> <li>○ DC 750W Gold</li> </ul> </li> </ul>



## Intel® Server System R1000WT Family TPS

Feature	Description
Storage Bay Options	<p><b>Hot Swap Backplane Options:</b></p> <p>Note: All available backplane options have support for SAS 3.0 (12 Gb/sec)</p> <ul style="list-style-type: none"> <li>○ 4 x 3.5" SAS/SATA backplane</li> <li>○ 8 x 2.5" SAS/SATA backplane</li> <li>○ 8 x 2.5" combo backplane – SAS/SATA + up to 4 x PCIe* SFF</li> </ul> <p><b>Storage Bay Options:</b></p> <ul style="list-style-type: none"> <li>○ 4 x 3.5" SAS/SATA hot swap drive bays + front panel I/O and optical drive support</li> <li>○ 8 x 2.5" SAS/SATA hot swap drive bays + front panel I/O or optical drive support</li> </ul>
Supported Rack Mount Kit Accessory Options	<ul style="list-style-type: none"> <li>▪ AXXPRAIL – Tool-less rack mount rail kit – 800mm max travel length</li> <li>▪ AXXLVRAIL – Enhanced value rack mount rail kit - 424mm max travel length</li> <li>▪ AXX1U2UCMA – Cable Management Arm – (*supported with AXXPRAIL only)</li> <li>▪ AXX2POSTBRCKT – 2-post fixed mount bracket kit</li> <li>▪ A1USHRTRAIL - 1U Premium quality rails with no CMA support</li> <li>▪ A1UFULLRAIL - 1U Premium quality rails with CMA support</li> </ul>

## 2.1 Operating System Support

As of this writing, Intel® Server System R1000WT product family provides support for the following operating systems. This list will be updated as new operating systems are validated by Intel.

**Table 2. Operating System Support List**

**Note:** The \* mark indicates it requires the drive driver to be recognize the drives during installation.

Operating System	Operating System Validation Level (P)	SATA RSTe SW RAID Support (Y/N)	SATA ESRT2 SW RAID Support (Y/N)
Windows Server 2012* R2 w/Updated Datacenter x64, Legacy boot	P1	Yes	Yes
Windows Server 2012* R2 w/Updated Datacenter x64, uEFI boot	P1	Yes	No
Windows Hyper-V 2012* R2 x64, Legacy boot	P1	No	No
Windows Hyper-V 2012 R2 x64, uEFI boot	P1	No	No
Red Hat Enterprise Linux 7.0* x64, Legacy boot	P1	No	Yes
Red Hat Enterprise Linux 7.0* x64, uEFI boot	P1	No	No
Red Hat Enterprise Linux 6.5* x64, Legacy boot	P1	Yes (with LEDMon <sup>1</sup> )	Yes
Red Hat Enterprise Linux 6.5* x64, uEFI boot	P1	Yes (with LEDMon <sup>1</sup> )	No
Red Hat Enterprise Linux 6.5 * x86, Legacy boot	P1	Yes (with LEDMon <sup>1</sup> )	Yes
Red Hat Enterprise Linux 7.1* x64, Legacy Boot	P1	Yes	Yes
Red Hat Enterprise Linux 7.1* x64, uEFI Boot	P1	Yes	Yes
Red Hat Enterprise Linux 7.2* x64, Legacy Boot	P1	Yes	Yes
Red Hat Enterprise Linux 7.2* x64, uEFI Boot	P1	Yes	Yes
SuSE Linux Enterprise Server 11* SP3 x64, Legacy Boot	P1	No	Yes
SuSE Linux Enterprise Server 11* SP3 x64, uEFI Boot	P1	No	No
SuSE Linux Enterprise Server 11* SP3 x86, Legacy Boot	P1	No	Yes
SuSE Linux Enterprise Server 12* SP1 SP4 x64, Legacy Boot	P1	Yes	Yes

<sup>1</sup> LEDmon version 0.79 has been tested and is supported by Intel. This version can be downloaded from the following public web site <http://sourceforge.net/projects/ledmon/files/ledmon-0.79>

**Intel® Server System R1000WT Family TPS**

Operating System	Operating System Validation Level (P)	SATA RSTe SW RAID Support (Y/N)	SATA ESRT2 SW RAID Support (Y/N)
SuSE Linux Enterprise Server 12* SP1 SP4 x64, uEFI Boot	P1	Yes	Yes
Windows Server 2008* R2 sp1 x64, Legacy Boot	P2	Yes	Yes
Windows Server 2008* R2 sp1 x64, uEFI Boot	P2	Yes	No
Windows Server 2008* R2 sp1 x86, Legacy Boot	P2	Yes	Yes
Windows 7* x64, Legacy boot	P2	Yes	Yes
Windows 7* x64, uEFI boot	P2	Yes	No
Windows 10* x64, uEFI Boot	P2	Yes	No
Windows 10* x64, Legacy Boot	P2	Yes	Yes
VMWare ESXi 5.5* U2	P2	No (AHCI mode only. No RAID support)	No
VMWare ESXi 6.0* U2	P2		
Ubuntu 14.04 Server* x64, Legacy Boot	P2	No	No
Ubuntu 14.04 Server* x64, EFI Boot	P2	No	No
Ubuntu 14.04 Server* x86, Legacy Boot	P2	No	No
CentOS 6.5* x64, Legacy Boot	P3	No	No
CentOS 6.5* x64, uEFI Boot	P3	No	No
CentOS 6.5* x86, Legacy Boot	P3	No	No
CentOS 7.1* x64, uEFI Boot	P3	Yes	Yes
CentOS 7.1* x64, Legacy Boot	P3	Yes	Yes
CentOS 7.2* x64, uEFI Boot	P3	Yes	Yes
CentOS 7.2* x64, Legacy Boot	P3	Yes	Yes
FreeBSD 10* x64 Legacy Boot	P3	No	No
FreeBSD 10* x86 Legacy Boot	P3	No	No

Table 3. Operating System Validation Levels

Operating System Validation Levels	P1	P2	P3
Basic Installation testing	Yes	Yes	Yes
Test all on-board I/O features in all modes	Yes		
Adapter\Peripheral Compatibility & Stress testing	Yes		
Technical Support Level	T1	T2	T3

See the following sections for additional information regarding validation levels and technical support levels as referenced in Table 3.

### 2.1.1 OS Validation Levels

**Basic installation** testing is performed with each supported operating system. The testing validates that the system can install the operating system and that the base hardware feature set is functional. A small set of peripherals is used for installation purposes only. Add-in adapter cards are not tested.

**Adapter compatibility validation (CV)** testing uses test suites to gain an accurate view of how the server performs with a wide variety of adapters under the primary supported operating systems. These tests are designed to show hardware compatibility between the cards and the server platform and include functional testing only. No heavy stressing of the systems or the cards is performed for CV testing.

**Stress Testing** uses configurations that include add-in adapters in all available slots for a 48-hour (two days), or a 72-hour (three days) test run without injecting errors. Each configuration passes an installation test and a Network/Disk Stress test. Any fatal errors that occur require a complete test restart.

### 2.1.2 OS Technical Support Levels

**T1:** Intel will provide support for issues involving the installation and/or functionality of a specified operating system as configured with or without supported adapters and/or peripherals.

**T2:** Intel will provide and test operating system drivers for each of the server board's integrated controllers, provided that the controller vendor has a driver available upon request. Vendors will not be required by Intel to develop drivers for operating systems that they do not already support. Intel will NOT provide support for issues related to the use of any add-in adapters or peripherals installed in the server system when an operating system that received only basic installation testing is in use.

**T3:** Intel will not provide technical support for an open source operating system. All questions and issues related to an open source operating system must be submitted to and supported by the open source community supporting the given operating system.

## 2.2 System Features Overview

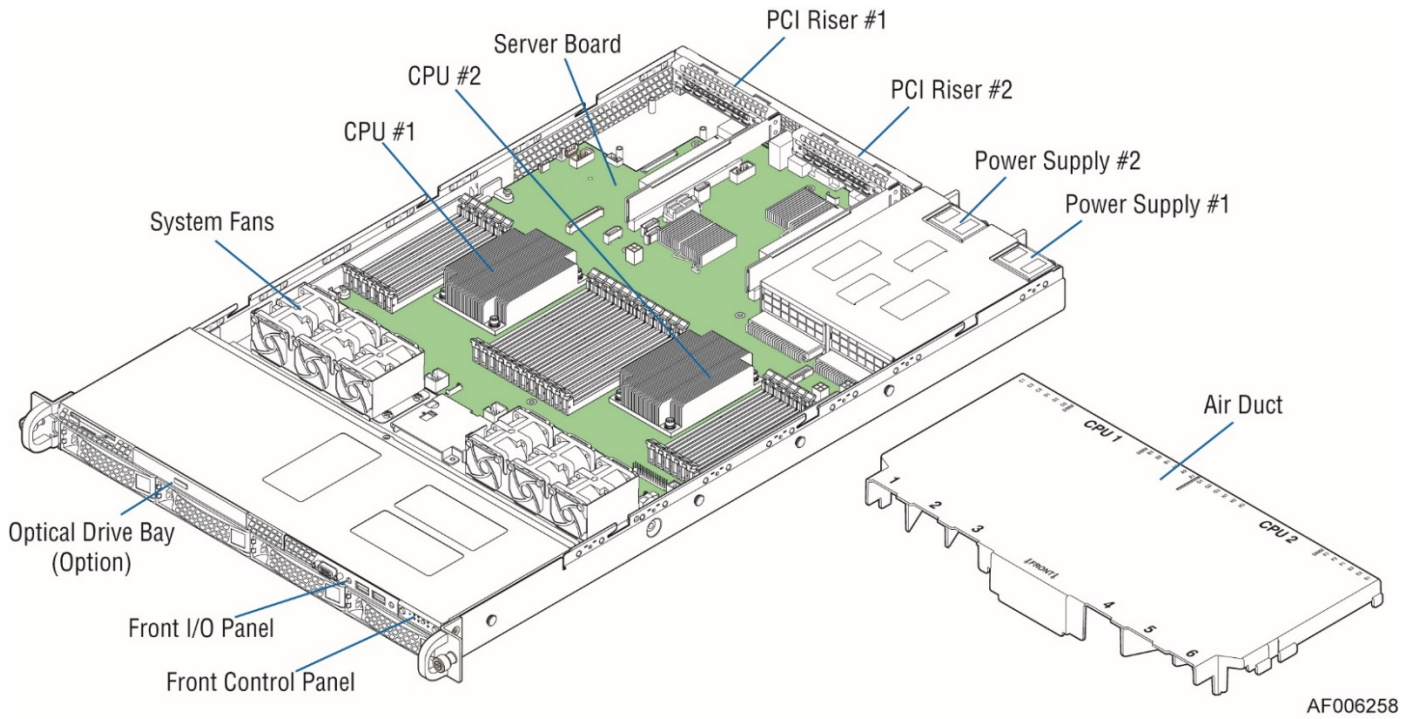

Figure 1. System Components Overview

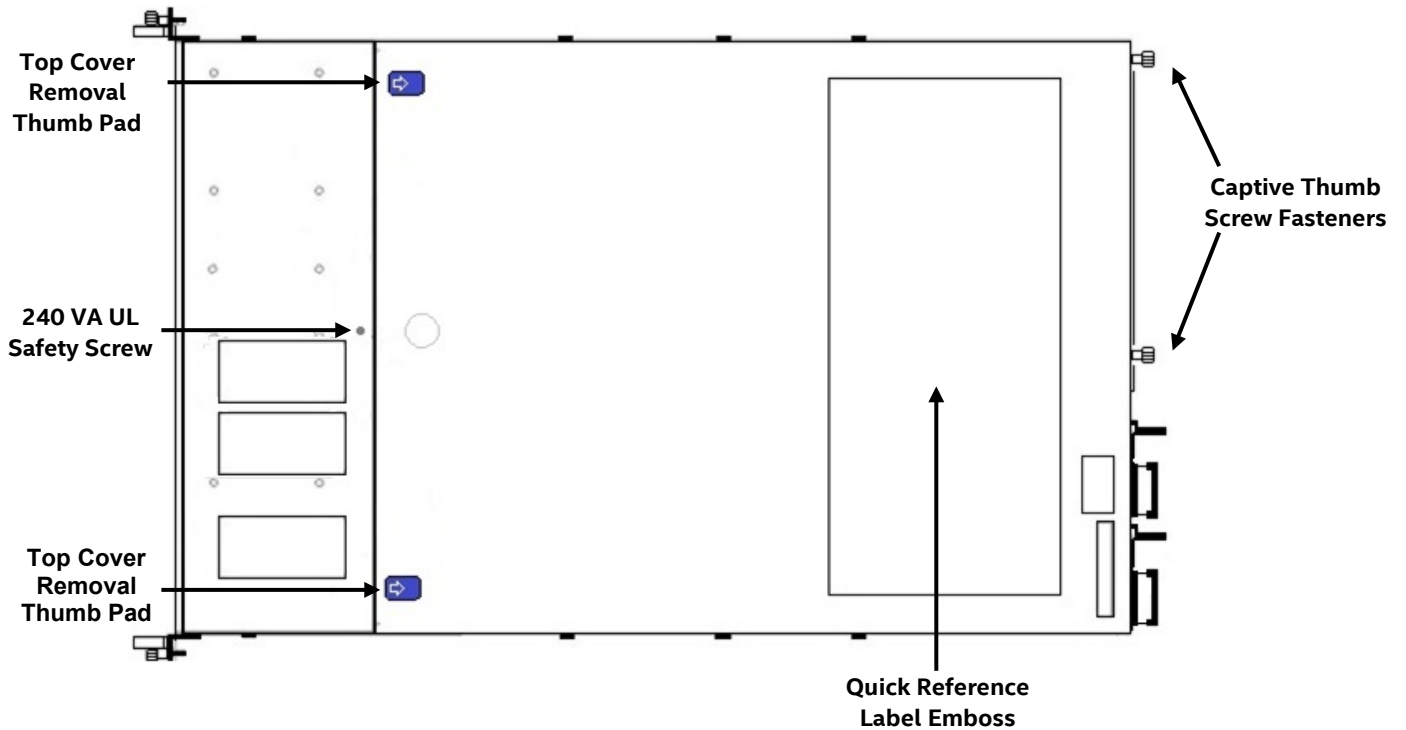

Figure 2. Top Cover Features

**Note:** The systems that includes a fastener screw towards on the front edge of the top cover is necessary to comply with 240VA UL Safety requirements. Systems that come without screws along the front edge of the top cover, the thumbscrews at the rear must be torqued to ~5.5 in/lb (0.9 Nm) to comply with 240VA UL safety requirements of some countries.

### 2.3 Server Board Features Overview

The following illustration provides a general overview of the server board, identifying key feature and component locations. Please refer to *Intel® Server Board S2600WT Technical Product Specification* for more information.

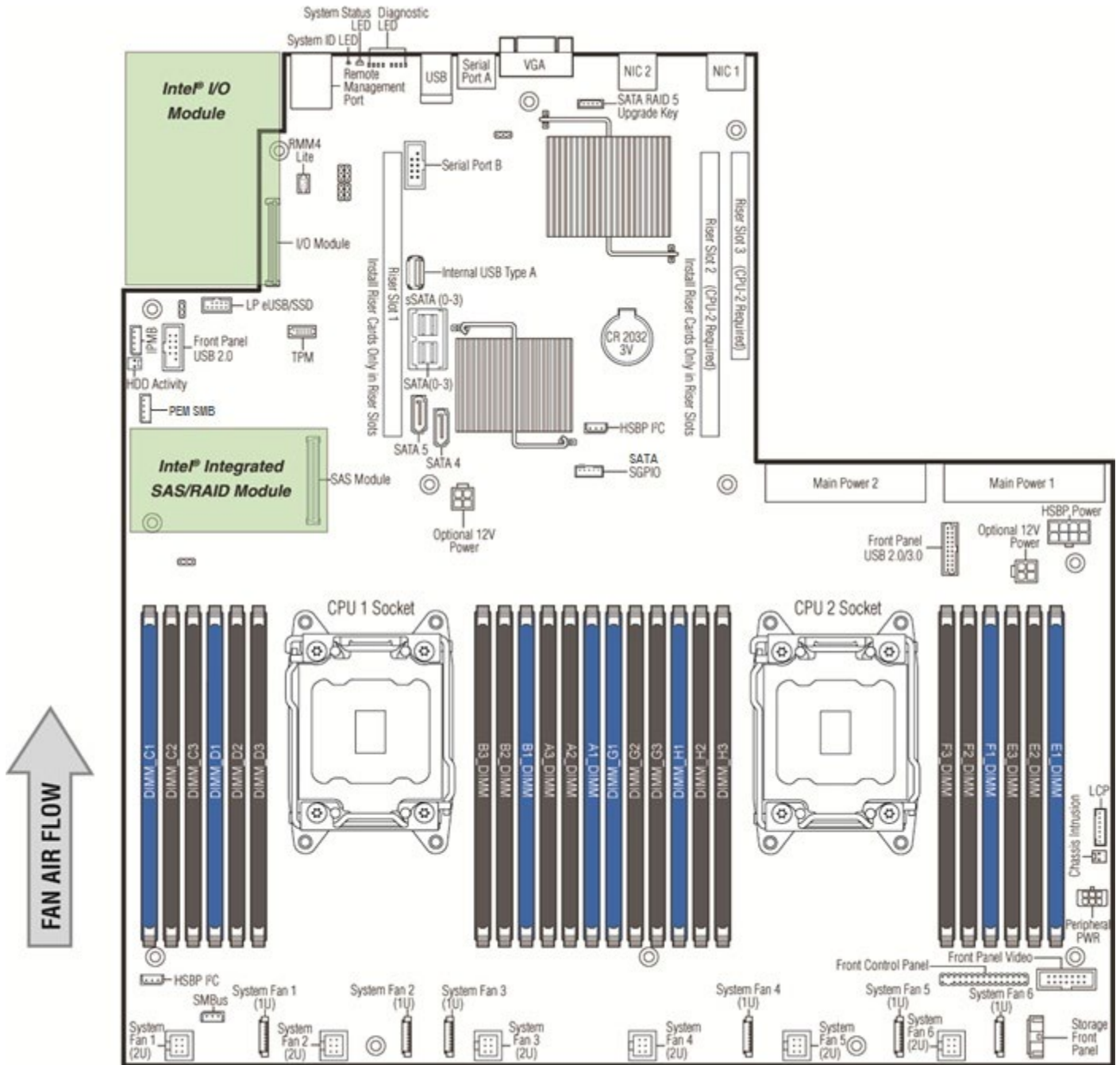
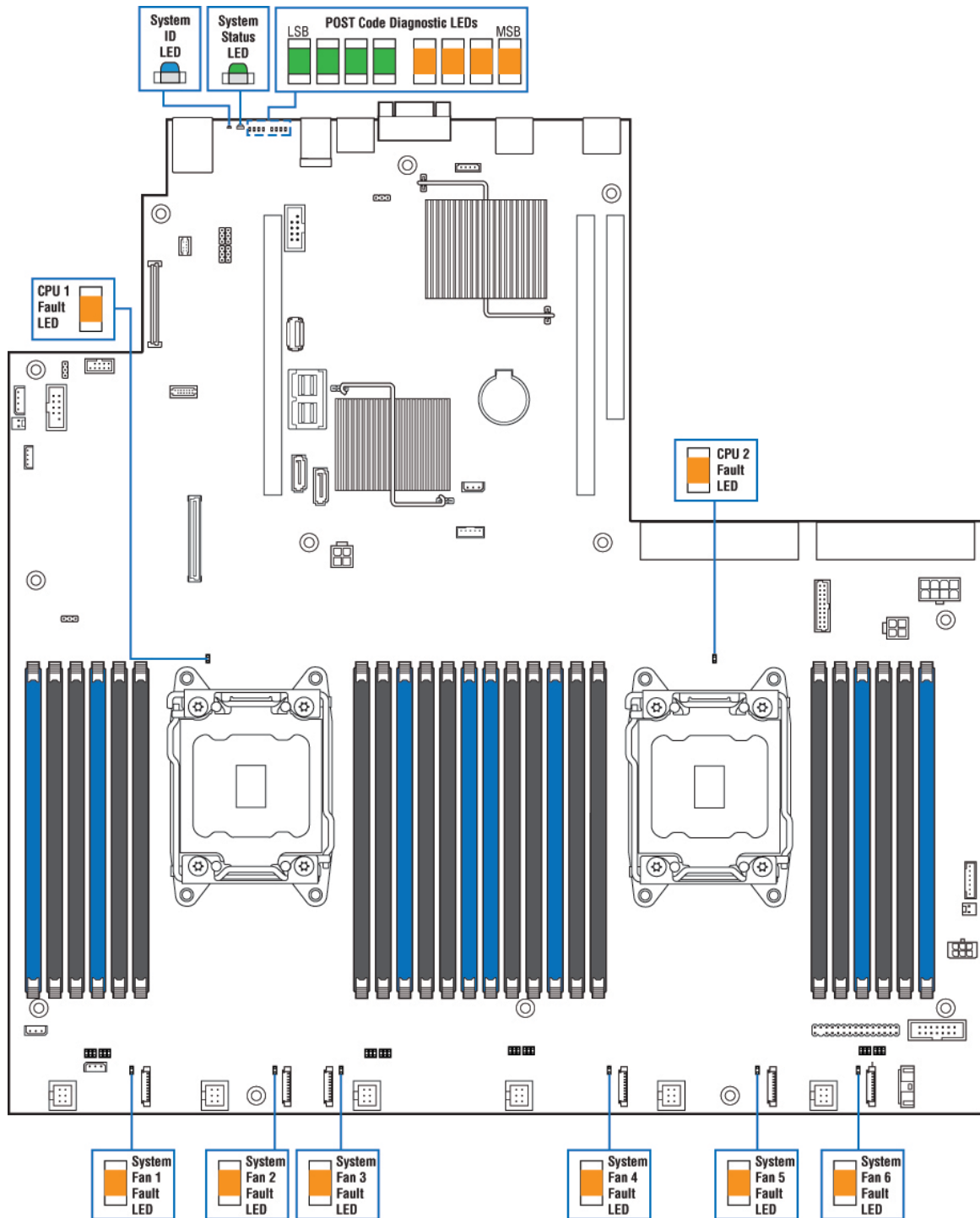

Figure 3. Server Board Features

The server board includes several LEDs to identify system status and / or indicate a component fault. The following illustrations define each Diagnostic LED and identify their location.



AF006475

Figure 4. On-board Light Guided Diagnostics

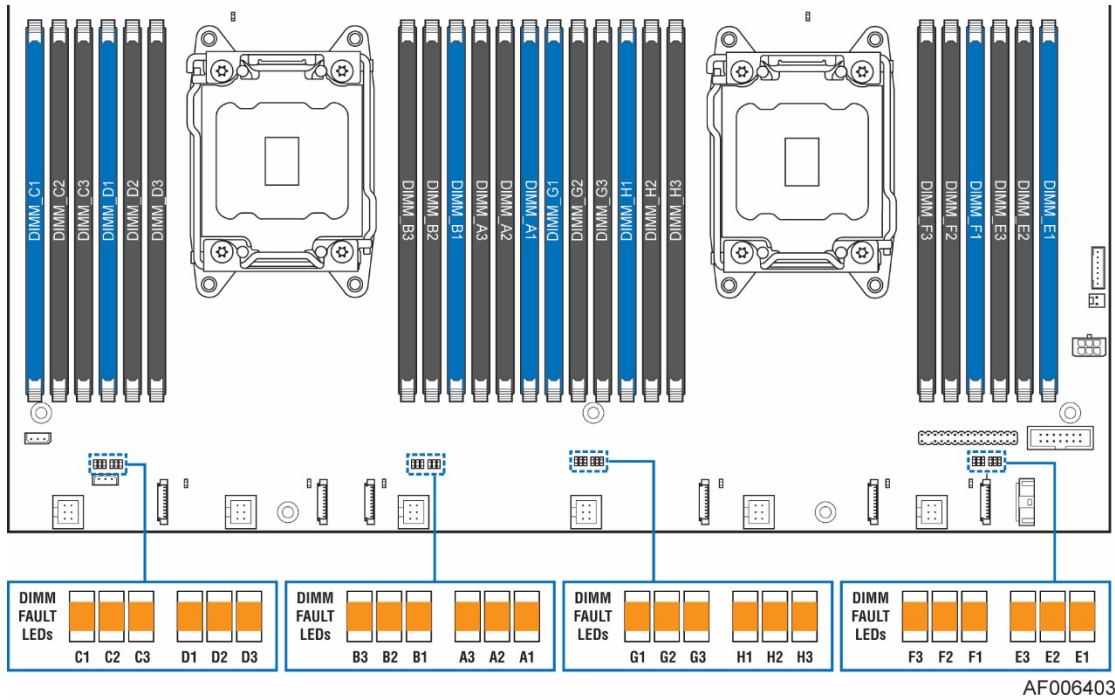

Figure 5. DIMM Fault LEDs

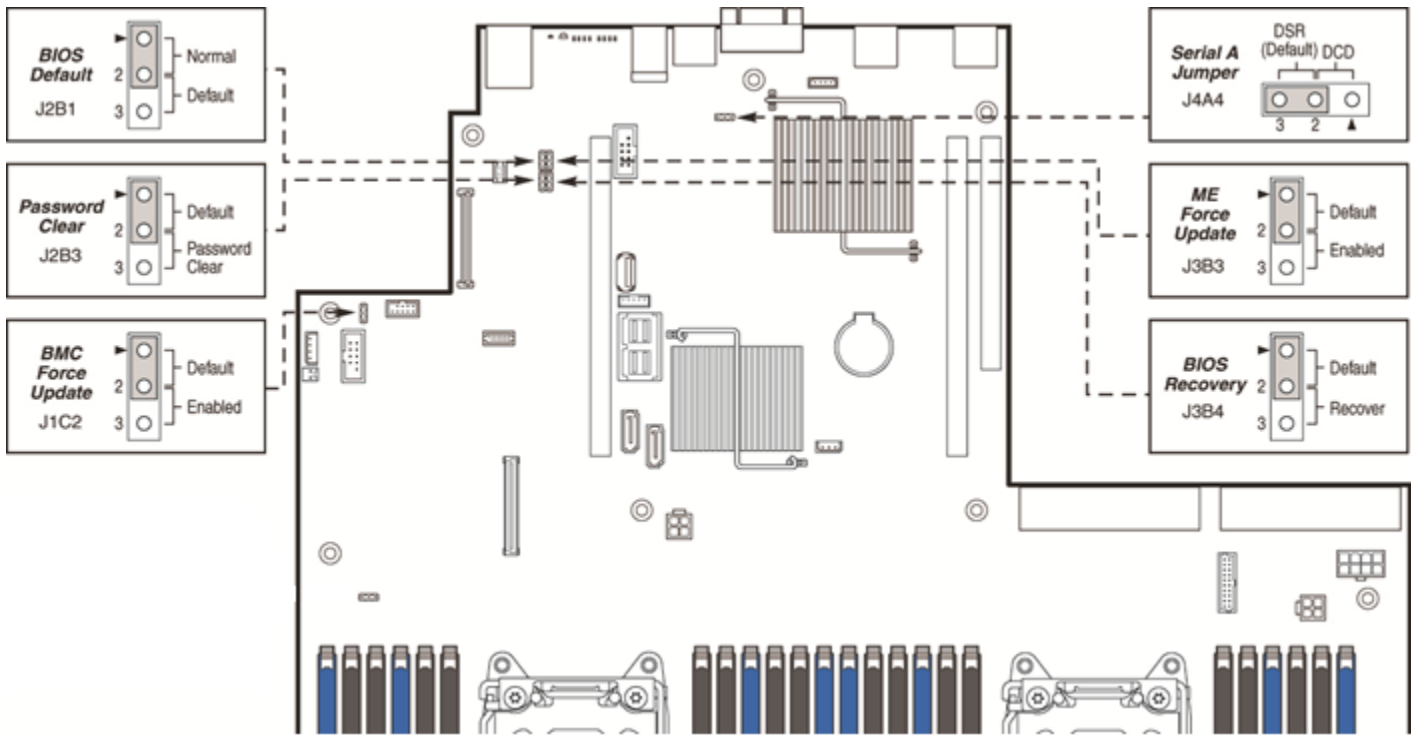

Figure 6. System Reset and Configuration Jumpers



## 2.4 Back Panel Features

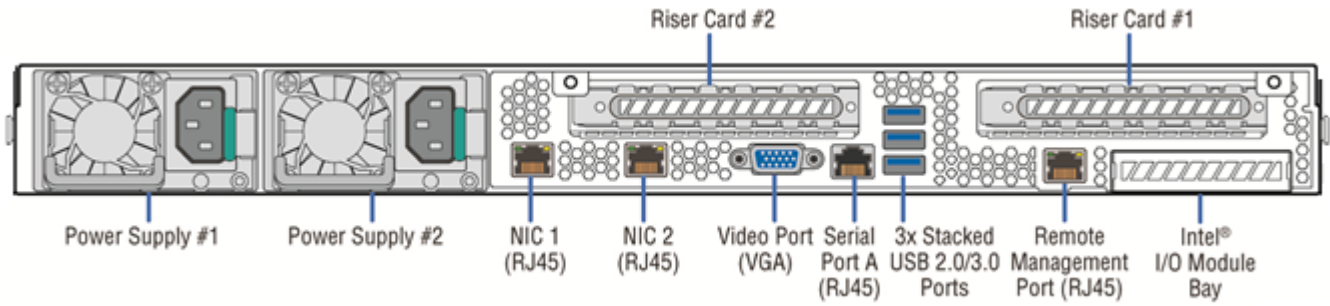
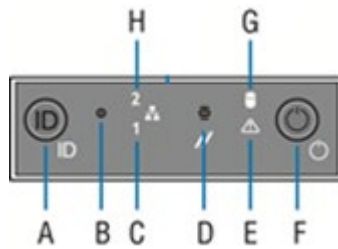

Figure 7. Back Panel Feature Identification

## 2.5 Front Control Panel



Label	Description	Label	Description
A	System ID Button w/Integrated LED	F	Power Button w/Integrated LED
B	NMI Button (recessed, tool required for use)	G	Hard Drive Activity LED
C	NIC-1 Activity LED	H	NIC-2 Activity LED
D	System Cold Reset Button (recessed, tool required for use)		
E	System Status LED		

Figure 8. Front Control Panel Options

## 2.6 Front Drive Bay Options

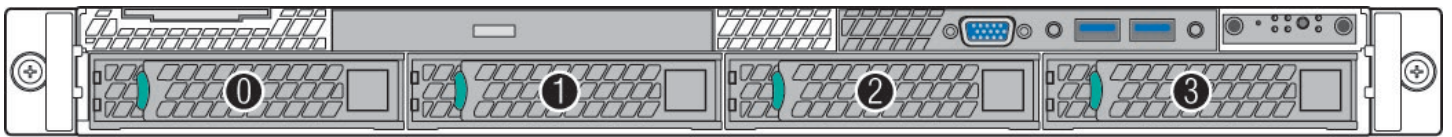

Figure 9. 3.5" Drive Bay – 4 Drive Configuration (Model R1304WTxxxx)

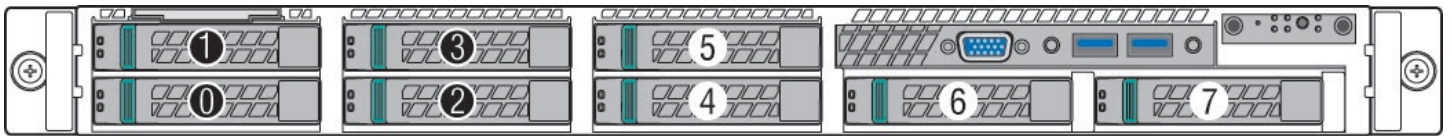
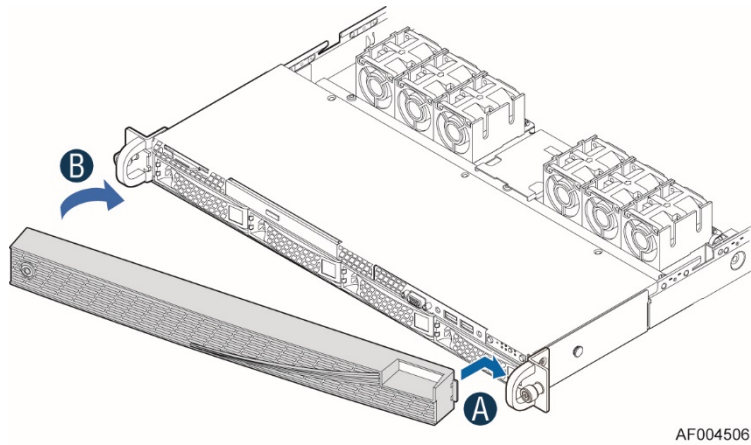

Figure 10. 2.5" Drive Bay – 8 Drive Configuration (Model R1208WTxxxx)



## 2.7 Locking Front Bezel

The optional front bezel is made of Black molded plastic and uses a snap-on design. When installed, its design allows for maximum airflow to maintain system cooling requirements. The front bezel includes a keyed locking mechanism which can be used to prevent unauthorized access to installed storage devices and front I/O ports.



AF004506

Figure 11. Front Bezel

(Intel Product Order Code – **A1UBEZEL**)

The face of the bezel assembly includes snap-in identification badge options and a wave feature option to allow for customization.

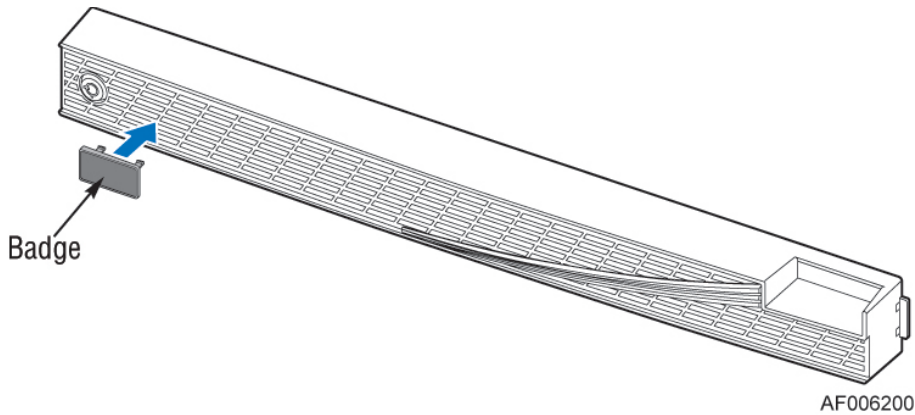

AF006200

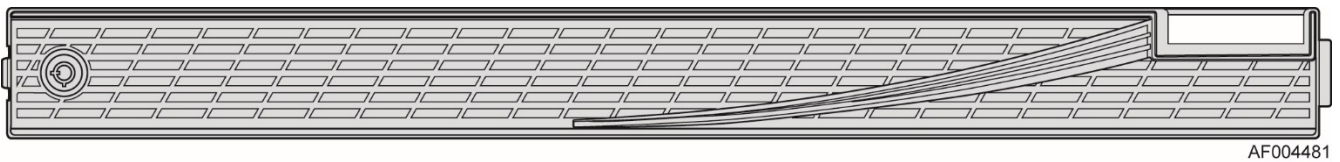

AF004481

Figure 12. Front Bezel accessory with optionally installed wave feature

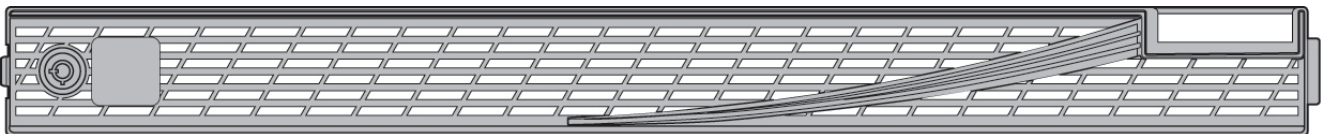

AF006314

Figure 13. Front Bezel accessory with optionally installed wave and ID badge (1)

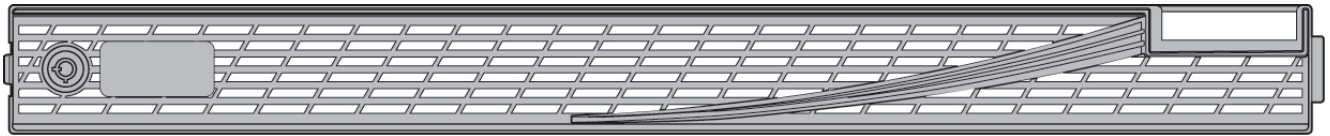

AF006315

Figure 14. Front Bezel accessory with optionally installed wave and ID badge (2)

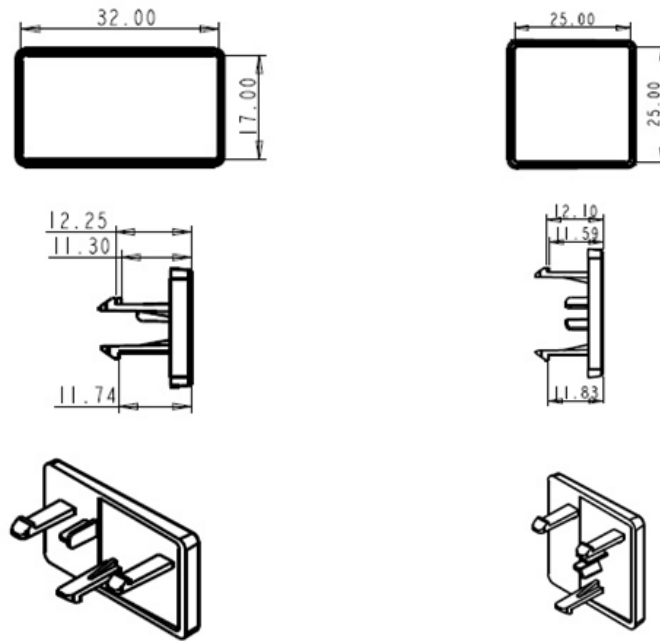

Figure 15. Front Bezel accessory ID Badge mechanical drawings

## 2.8 System Dimensions

### 2.8.1 Chassis Dimensions

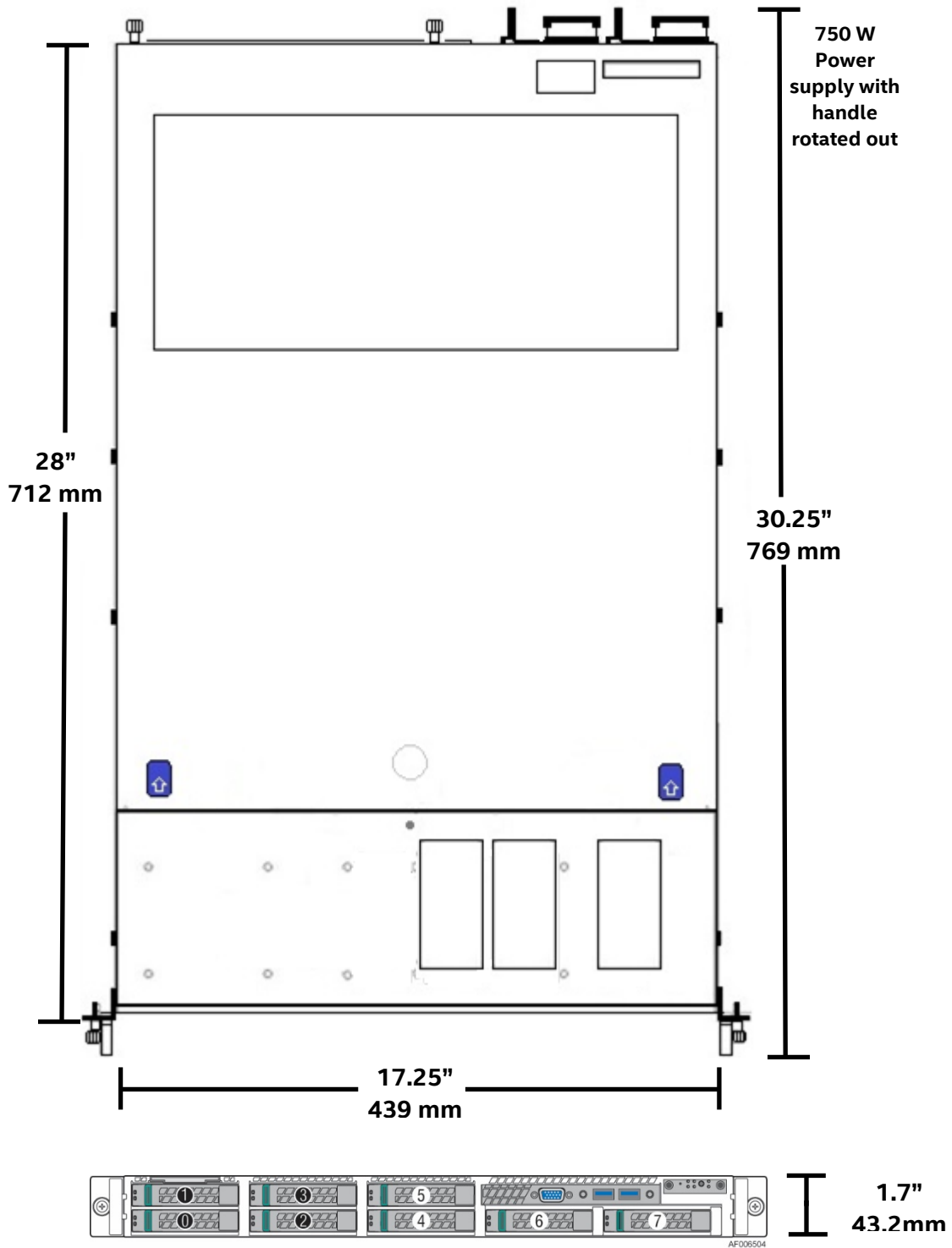

Figure 16. Chassis Dimensions

## 2.8.2 Label Emboss Dimensions

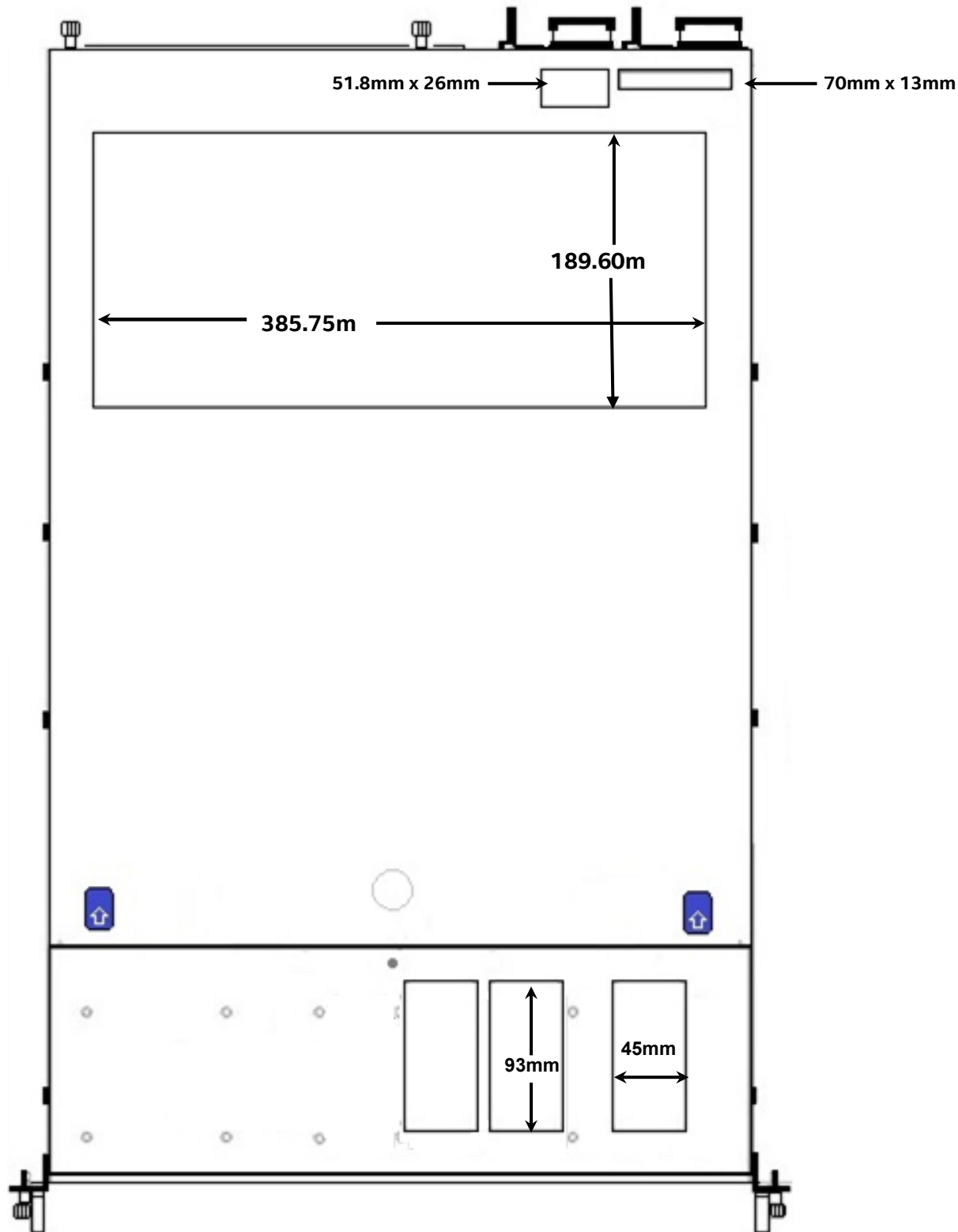

Figure 17. Label Emboss Dimensions

### 2.8.3 Pull-out Tab Label Emboss Dimensions

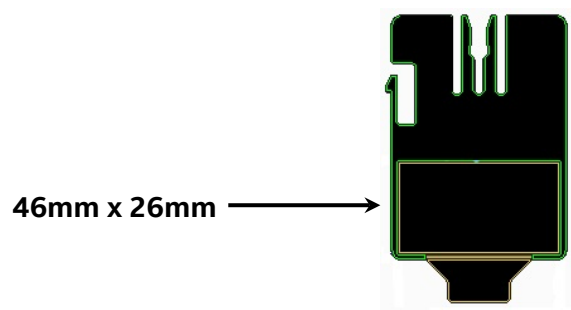

Figure 18. Pull-out Tab Label Emboss Dimensions

## 2.9 System Cable Routing Channels

The 1U system provides a cable routing channel (front-to-back / back-to-front) along each chassis sidewall. No cables should be routed directly in front of the system fans or through the center of the server board between the memory slots and CPU sockets. See Appendix E. for system cable routing diagrams.

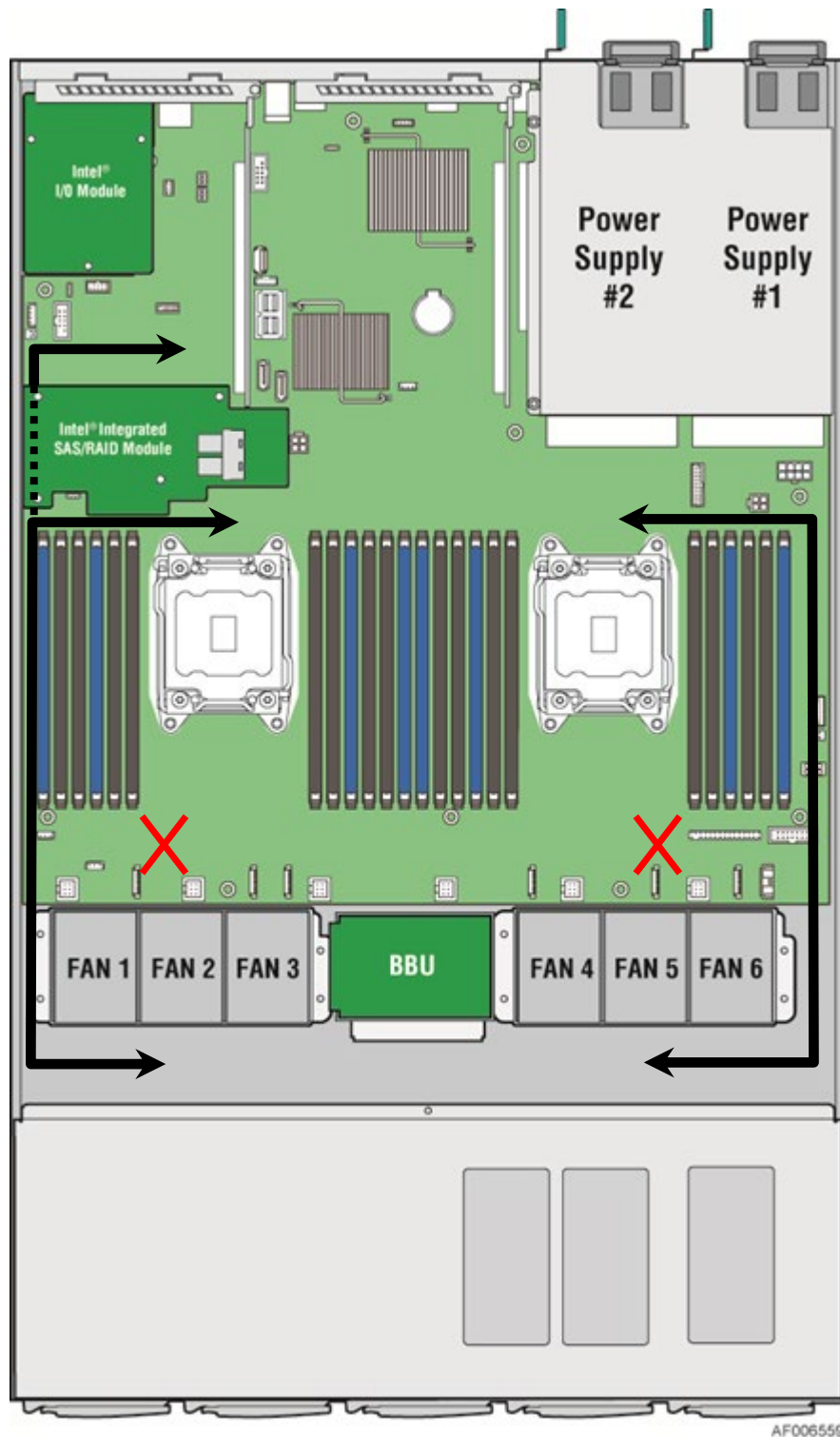

Figure 19. System Cable Routing Channels

## 2.10 Available Rack and Cabinet Mounting Kit Options

**Advisory Note** – Available rack and cabinet mounting kits are not designed to support shipment of the server system while installed in a rack. If you chose to do so, Intel advises you verify your shipping configuration with appropriate shock and vibration testing, before shipment. Intel does not perform shipping tests which cover the complex combination of unique rack offerings and custom packaging options.

**Caution:** Exceeding the rail kit's specified maximum weight limit or misalignment of the server in the rack may result in failure of the rack rails, resulting in damage to the system or personal injury. Two people or the use of a mechanical assist tool to install and align the server into the rack is highly recommended.

- **AXXPRAIL** – Tool-less rack mount rail kit
  - 1U and 2U compatible
  - 800mm max travel length
  - 54 lbs (24 Kgs) max support weight
  - Tool-less installation
  - Full extension from rack
  - Drop in system install
  - Optional cable management arm support
- **AXXELVRAIL** – Enhanced Value rack mount rail kit
  - 1U to 4U compatible
  - 130 lbs (59 Kgs) max support weight
  - Tool-less chassis attach
  - Tools required to attach to rails to rack
  - 2/3 extension from rack
  - Improved robustness over AXXVRAIL, same mechanical spec
- **AXX1U2UCMA** – Cable Management Arm – \*supported with AXXPRAIL only
- **AXX2POSTBRCKT** – 2-Post Fixed mount bracket kit
  - 1U and 2U compatible
  - Tools required to attach components to rack
- **A1USHRTRAIL** - 1U Premium quality rails with no CMA support
  - Travel distance 780mm
  - Full extension from rack
  - Kit includes: Rails, screws, installation manual
- **A1UFULLRAIL** - 1U Premium quality rails with CMA support.
  - Travel distance 780mm
  - Full extension from rack
  - Kit includes: Rails, screws, installation manual
  - For Cable Management arm support – order iPC AXX1U2UCMA

## 2.11 System Level Environmental Limits

The following table defines the system level operating and non-operating environmental limits.

**Table 4. System Environmental Limits Summary**

Parameter	Limits			
Temperature				
	Operating	ASHRAE Class A2 – Continuous Operation. 10° C to 35° C (50° F to 95° F) with the maximum rate of change not to exceed 10°C per hour		
		ASHRAE Class A3 – Includes operation up to 40C for up to 900 hrs per year.		
		ASHRAE Class A4 – Includes operation up to 45C for up to 90 hrs per year.		
	Shipping	-40° C to 70° C (-40° F to 158° F)		
Altitude				
	Operating	Support operation up to 3050m with ASHRAE class deratings.		
Humidity				
	Shipping	50% to 90%, non-condensing with a maximum wet bulb of 28° C (at temperatures from 25° C to 35° C)		
Shock				
	Operating	Half sine, 2g, 11 mSec		
	Unpackaged	Trapezoidal, 25 g, velocity change is based on packaged weight		
	Packaged	ISTA (International Safe Transit Association) Test Procedure 3A 2008		
Vibration				
	Unpackaged	5 Hz to 500 Hz 2.20 g RMS random		
	Packaged	ISTA (International Safe Transit Association) Test Procedure 3A 2008		
AC-DC				
	Voltage	90 Hz to 132 V and 180 V to 264 V		
	Frequency	47 Hz to 63 Hz		
	Source Interrupt	No loss of data for power line drop-out of 12 mSec		
	Surge Non-operating and operating	Unidirectional		
	Line to earth Only	AC Leads	2.0 kV	
		I/O Leads	1.0 kV	
		DC Leads	0.5 kV	
ESD				
	Air Discharged	12.0 kV		
	Contact Discharge	8.0 kV		
Acoustics Sound Power Measured				
	<b>Power in Watts</b>	<300 W	≥300 W	≥600 W ≥1000 W
	Servers/Rack Mount Sound Power Level (in BA)	7.0	7.0	7.0 7.0

See Appendix D in this document or the *Intel® Server Board S2600WT Product Family Power Budget and Thermal Configuration Tool* for system configuration requirements and limitations.



## 2.12 System Packaging

The original Intel packaging, in which the server system is delivered, is designed to provide protection to a fully configured system and was tested to meet ISTA (International Safe Transit Association) Test Procedure 3A (2008). The packaging was also designed to be re-used for shipment after system integration has been completed.

The original packaging includes two layers of boxes – an inner box and the outer shipping box, and various protective inner packaging components. The boxes and packaging components are designed to function together as a protective packaging system. When reused, all of the original packaging material must be used, including both boxes and each inner packaging component. In addition, all inner packaging components MUST be reinstalled in the proper location to ensure adequate protection of the system for subsequent shipment.

**NOTE:** The design of the inner packaging components does not prevent improper placement within the packaging assembly. There is only one correct packaging assembly that will allow the package to meet the ISTA (International Safe Transit Association) Test Procedure 3A (2008) limits. See *the Intel® Server System R1000WT Product Family System Integration and Service Guide* for complete packaging assembly instructions.

Failure to follow the specified packaging assembly instructions may result in damage to the system during shipment.

### Outer Shipping Box External Dimensions:

Length = 983mm

Breadth = 577mm

Height = 260mm

### Inner Box Internal Dimensions:

Length = 956mm

Breadth = 550mm

Height = 202mm

### 2.12.1 Intel Product Weight Information

Product code	Product Type	Packaged Gross Weight (Kg)	Packaged Gross Weight (Lbs)	Un-packaged Net Weight (Kg)	Un-packaged Net Weight (Lbs)
R1304WTXXX	Chassis Only	19.0	41.9	10.3	22.7
R1208WTXXX	Chassis Only	19.0	41.9	10.3	22.7
R1304WTTGSR	L6 System	21.3	47.0	12.3	27.1
R1304WT2GSR	L6 System	21.3	47.0	12.3	27.1
R1208WTTGSR	L6 System	21.1	46.5	12.9	28.4
R1208WT2GSR	L6 System	21.1	46.5	12.9	28.4

Note: An L6 system does not include processors, memory, drives, or add-in cards. It is the system configuration as shipped from Intel. Integrated system weights (System configurations that include the items above) will vary depending on the final system configuration. For the 1U product family, a fully integrated un-packaged system can weigh upwards of 40 Lbs (18+ Kg).

## 3. System Power

This chapter provides a high level overview of the features and functions related to system power.

### 3.1 Power Supply Configurations

The server system can have up to two power supply modules installed, supporting the following power supply configurations: 1+0 (single power supply), 1+1 Redundant Power, and 2+0 Combined Power (non-redundant). 1+1 redundant power and 2+0 combined power configurations are automatically configured depending on the total power draw of the system. If the total system power draw exceeds the power capacity of a single power supply module, then power from the 2<sup>nd</sup> power supply module will be utilized. Should this occur, power redundancy is lost. In a 2+0 power configuration, total power available maybe less then twice the rated power of the installed power supply modules due to the amount of heat produced with both supplies providing peak power. Should system thermals exceed programmed limits, platform management will attempt to keep the system operational. See *Closed Loop System Throttling (CLST)* later in this chapter, and Chapter 4 *Thermal Management*, for details.

**Caution: Installing two Power Supply Units with different wattage ratings in a system is not supported. Doing so will not provide Power Supply Redundancy and will result in multiple errors being logged by the system.**

The power supplies are modular, allowing for tool-less insertion and extraction from a bay in the back of the chassis. When inserted, the card edge connector of the power supply mates blindly to a matching slot connector on the server board.

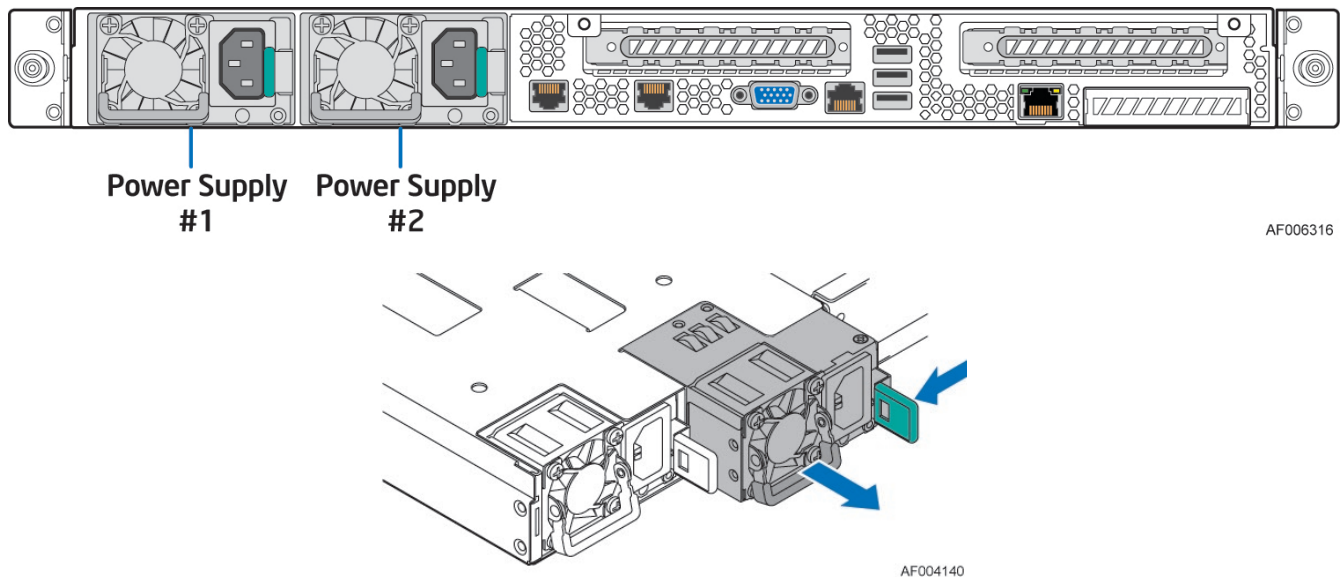

Figure 20. 750W AC Power Supply

In the event of a power supply failure, redundant 1+1 power supply configurations have support for hot-swap extraction and insertion. The AC input is auto-ranging and power factor corrected.

### 3.2 Power Supply Module Options

There are two power supply options available for this server product family: 750W AC Platinum and 750W DC Gold.

#### 3.2.1 Power Supply Module Efficiency

The following tables provide the required minimum efficiency level at various loading conditions. These are provided at three different load levels: 100%, 50%, and 20%.

The AC power supply efficiency is tested over an AC input voltage range of 115 VAC to 220 VAC.

**Table 5. 750 Watt AC Power Supply Efficiency (Platinum)**

Loading	100% of maximum	50% of maximum	20% of maximum	10% of maximum
Minimum Efficiency	91%	94%	90%	82%

The DC power supply efficiency is tested with a -53V DC input.

**Table 6. 750 Watt DC Power Supply Efficiency (Gold)**

Loading	100% of maximum	50% of maximum	20% of maximum	10% of maximum
Minimum Efficiency	88%	92%	88%	80%

#### 3.2.2 Power Supply Module Mechanical Overview



**750W AC Power Supply module with single fan**

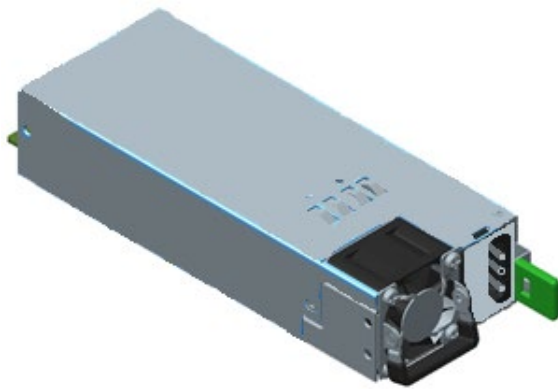

**750W DC Power Supply Module**

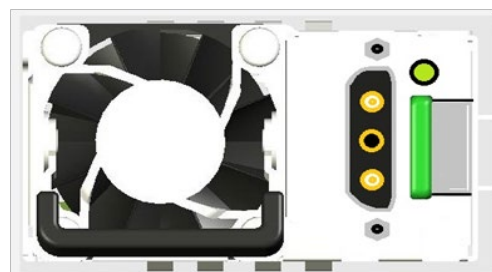
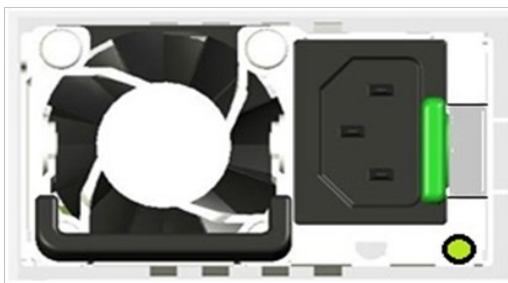

**AC and DC Power Cable Connectors**

**Figure 21. Power Supply Module Overview**

The physical size of the 750W AC power supply enclosure is 39mm x 74mm x 185mm. The power supply contains a single 40mm fan. The power supply has a card edge output that interfaces with a 2x25 card edge connector in the system. The AC plugs directly into the external face of the power supply.

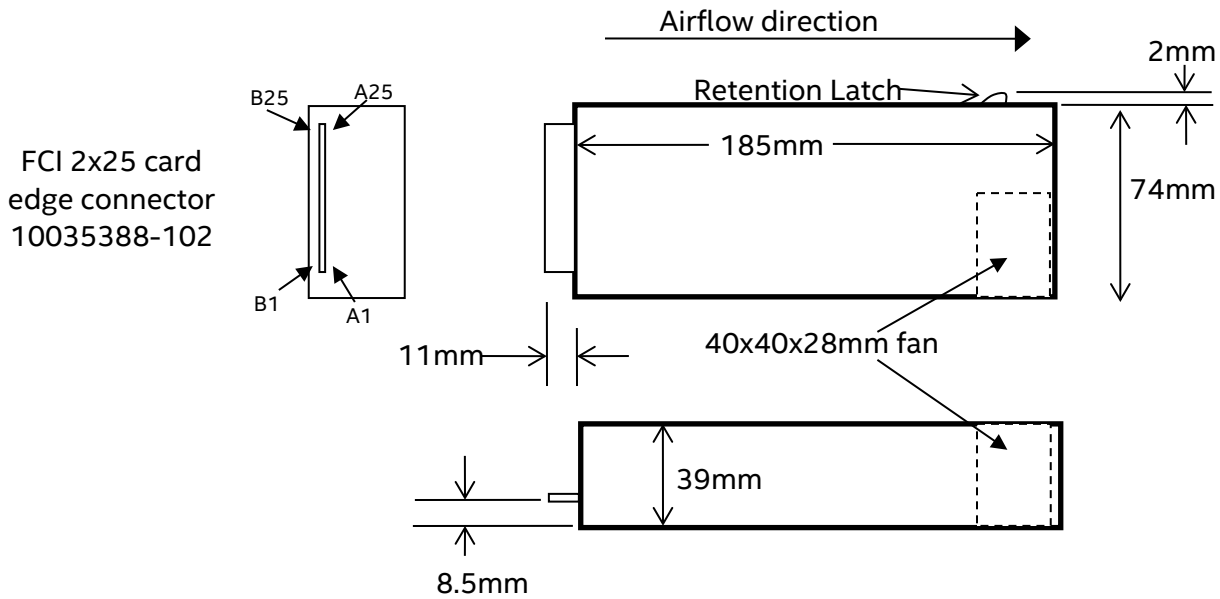

Figure 22. 750W AC Power Supply Module Mechanical Drawing

### 3.2.3 Power Cord Specification Requirements

The AC power cord used must meet the specification requirements listed in the following table.

Table 7. AC Power Cord Specifications

Cable Type	SJT
Wire Size	16 AWG
Temperature Rating	105°C
Amperage Rating	13 A
Voltage Rating	125 V

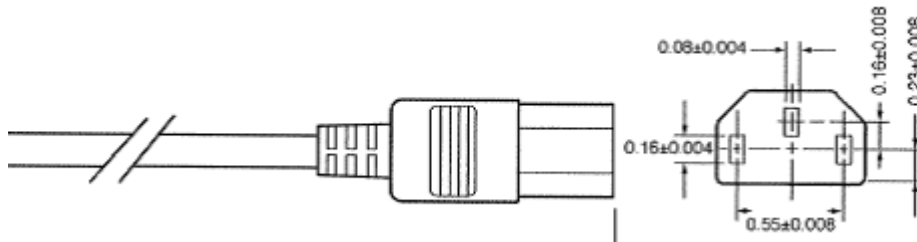

Figure 23. AC Power Cord

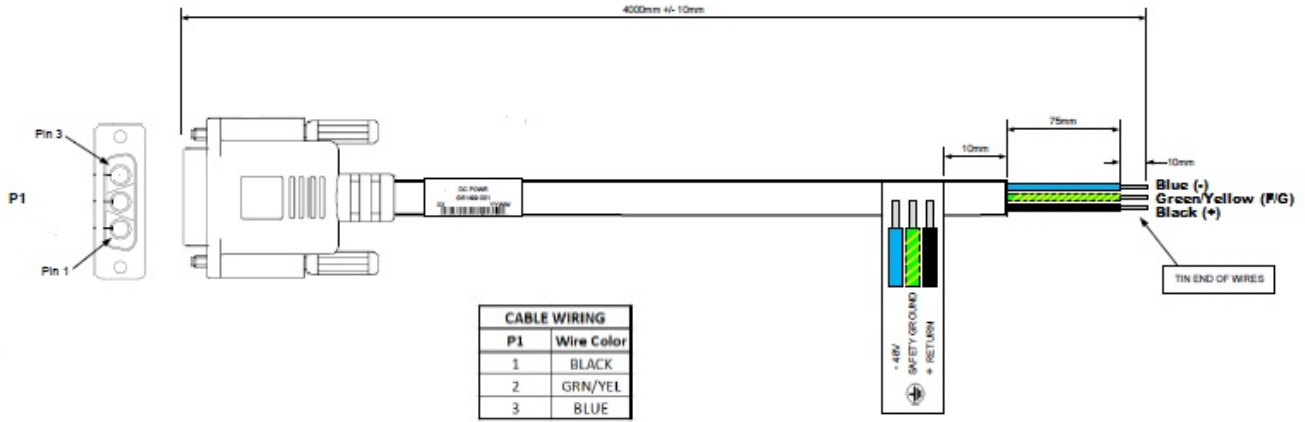

Figure 24. DC Power Cord Specification

Table 8. DC Power Cable Connector Pin-out

Pin	Definition
1	+ Return
2	Safety Ground
3	- 48V

### 3.3 AC Power Supply Input Specifications

The following sections provide the AC Input Specifications for systems configured with AC power supply modules.

#### 3.3.1 Power Factor

The power supply must meet the power factor requirements stated in the Energy Star® Program Requirements for Computer Servers. These requirements are stated below.

Output power	10% load	20% load	50% load	100% load
Power factor	> 0.65	> 0.80	> 0.90	> 0.95

Tested at 230Vac, 50Hz and 60Hz and 115VAC, 60Hz.

#### 3.3.2 AC Input Voltage Specification

The power supply must operate within all specified limits over the following input voltage range. Harmonic distortion of up to 10% of the rated line voltage must not cause the power supply to go out of specified limits. Application of an input voltage below 85VAC shall not cause damage to the power supply, including a blown fuse.

Table 9. AC Input Voltage Range – 750W Power Supply

PARAMETER	MIN	RATED	VMAX	Start-up VAC	Power-off VAC
Voltage (110)	90 Vrms	100-127 Vrms	140 Vrms	85VAC +/-4VAC	70VAC +/-5VAC
Voltage (220)	180 Vrms	200-240 Vrms	264 Vrms		
Frequency	47 Hz	50/60	63 Hz		

1. Maximum input current at low input voltage range shall be measured at 90VAC, at max load.
2. Maximum input current at high input voltage range shall be measured at 180VAC, at max load.
3. This requirement is not to be used for determining agency input current markings.

### 3.3.3 AC Line Isolation Requirements

The power supply shall meet all safety agency requirements for dielectric strength. Transformers' isolation between primary and secondary windings must comply with the 3000Vac (4242Vdc) dielectric strength criteria. If the working voltage between primary and secondary dictates a higher dielectric strength test voltage the highest test voltage should be used. In addition the insulation system must comply with reinforced insulation per safety standard IEC 950. Separation between the primary and secondary circuits, and primary to ground circuits, must comply with the IEC 950 spacing requirements.

### 3.3.4 AC Line Dropout / Holdup

An AC line dropout is defined to be when the AC input drops to 0VAC at any phase of the AC line for any length of time. During an AC dropout the power supply must meet dynamic voltage regulation requirements. An AC line dropout of any duration shall not cause tripping of control signals or protection circuits. If the AC dropout lasts longer than the holdup time the power supply should recover and meet all turn on requirements. The power supply shall meet the AC dropout requirement over rated AC voltages and frequencies. A dropout of the AC line for any duration shall not cause damage to the power supply.

**Table 10. AC Line Holdup Time – 750W Power Supply**

Loading	Holdup time
70%	12msec

#### 3.3.4.1 AC Line 12VSB Holdup

The 12VSB output voltage should stay in regulation under its full load (static or dynamic) during an AC dropout of **70ms min** (=12VSB holdup time) whether the power supply is in ON or OFF state (PSON asserted or de-asserted).

### 3.3.5 AC Line Fuse

The power supply shall have one line fused in the **single line fuse** on the line (Hot) wire of the AC input. The line fusing shall be acceptable for all safety agency requirements. The input fuse shall be a slow blow type. AC inrush current shall not cause the AC line fuse to blow under any conditions. All protection circuits in the power supply shall not cause the AC fuse to blow unless a component in the power supply has failed. This includes DC output load short conditions.

### 3.3.6 AC Inrush

AC line inrush current shall not exceed **55A peak**, for up to one-quarter of the AC cycle, after which, the input current should be no more than the specified maximum input current. The peak inrush current shall be less than the ratings of its critical components (including input fuse, bulk rectifiers, and surge limiting device).

The power supply must meet the inrush requirements for any rated AC voltage, during turn on at any phase of AC voltage, during a single cycle AC dropout condition as well as upon recovery after AC dropout of any duration, and over the specified temperature range ( $T_{op}$ ).

### 3.3.7 AC Line Transient Specification

AC line transient conditions shall be defined as “sag” and “surge” conditions. “Sag” conditions are also commonly referred to as “brownout”, these conditions will be defined as the AC line voltage dropping below nominal voltage conditions. “Surge” will be defined to refer to conditions when the AC line voltage rises above nominal voltage.

The power supply shall meet the requirements under the following AC line sag and surge conditions.

Table 11. AC Line Sag Transient Performance

AC Line Sag (10sec interval between each sagging)				
Duration	Sag	Operating AC Voltage	Line Frequency	Performance Criteria
0 to 1/2 AC cycle	95%	Nominal AC Voltage ranges	50/60Hz	No loss of function or performance
> 1 AC cycle	>30%	Nominal AC Voltage ranges	50/60Hz	Loss of function acceptable, self-recoverable

Table 12. AC Line Surge Transient Performance

AC Line Surge				
Duration	Surge	Operating AC Voltage	Line Frequency	Performance Criteria
Continuous	10%	Nominal AC Voltages	50/60Hz	No loss of function or performance
0 to ½ AC cycle	30%	Mid-point of nominal AC Voltages	50/60Hz	No loss of function or performance

### 3.3.8 Susceptibility Requirements

The power supply shall meet the following electrical immunity requirements when connected to a cage with an external EMI filter which meets the criteria defined in the SSI document EPS Power Supply Specification. For further information on Intel standards please request a copy of the Intel Environmental Standards Handbook.

Table 13. Performance Criteria

Level	Description
A	The apparatus shall continue to operate as intended. No degradation of performance.
B	The apparatus shall continue to operate as intended. No degradation of performance beyond spec limits.
C	Temporary loss of function is allowed provided the function is self-recoverable or can be restored by the operation of the controls.

### 3.3.9 Electrostatic Discharge Susceptibility

The power supply shall comply with the limits defined in EN 55024: 1998/A1: 2001/A2: 2003 using the IEC 61000-4-2: Edition 1.2: 2001-04 test standard and performance criteria B defined in Annex B of CISPR 24.

### 3.3.10 Fast Transient/Burst

The power supply shall comply with the limits defined in EN55024: 1998/A1: 2001/A2: 2003 using the IEC 61000-4-4: Second edition: 2004-07 test standard and performance criteria B defined in Annex B of CISPR 24.

### 3.3.11 Radiated Immunity

The power supply shall comply with the limits defined in EN55024: 1998/A1: 2001/A2: 2003 using the IEC 61000-4-3: Edition 2.1: 2002-09 test standard and performance criteria A defined in Annex B of CISPR 24.

### 3.3.12 Surge Immunity

The power supply shall be tested with the system for immunity to the following for each power supply option:

- **750W Power Supply** – AC Unidirectional wave; 2kV line to ground and 1kV line to line, per EN 55024: 1998/A1: 2001/A2: 2003, EN 61000-4-5: Edition 1.1:2001-04 .

The pass criteria include: No unsafe operation is allowed under any condition; all power supply output voltage levels to stay within proper spec levels; No change in operating state or loss of data during and after the test profile; No component damage under any condition.

The power supply shall comply with the limits defined in EN55024: 1998/A1: 2001/A2: 2003 using the IEC 61000-4-5: Edition 1.1:2001-04 test standard and performance criteria B defined in Annex B of CISPR 24.

**3.3.13 Power Recovery**

The power supply shall recover automatically after an AC power failure. AC power failure is defined to be any loss of AC power that exceeds the dropout criteria.

**3.3.14 Voltage Interruptions**

The power supply shall comply with the limits defined in EN55024: 1998/A1: 2001/A2: 2003 using the IEC 61000-4-11: Second Edition: 2004-03 test standard and performance criteria C defined in Annex B of CISPR 24.

**3.3.15 Protection Circuits**

Protection circuits inside the power supply cause only the power supply’s main outputs to shut down. If the power supply latches off due to a protection circuit tripping, an AC cycle OFF for 15 seconds and a PSON# cycle HIGH for one second reset the power supply.

**3.3.15.1 Over-current Protection (OCP)**

The power supply shall have current limit to prevent the outputs from exceeding the values shown in table below. If the current limits are exceeded the power supply shall shutdown and latch off. The latch will be cleared by toggling the PSON# signal or by an AC power interruption. The power supply shall not be damaged from repeated power cycling in this condition. 12VSB will be auto-recovered after removing OCP limit.

**Table 14. Over Current Protection – 750 Watt Power Supply**

Output Voltage	Input voltage range	Over Current Limits
+12V	90 – 264VAC	72A min; 78A max
12VSB	90 – 264VAC	2.5A min; 3.5A max

**3.3.15.2 Over-voltage Protection (OVP)**

The power supply over voltage protection shall be locally sensed. The power supply shall shutdown and latch off after an over voltage condition occurs. This latch shall be cleared by an AC power interruption. The values are measured at the output of the power supply’s connectors. The voltage shall never exceed the maximum levels when measured at the power connectors of the power supply connector during any single point of fail. The voltage shall never trip any lower than the minimum levels when measured at the power connector. 12VSB will be auto-recovered after removing OVP limit.

**Table 15. Over Voltage Protection (OVP) Limits – 750W Power Supply**

Output Voltage	MIN (V)	MAX (V)
+12V	13.3	14.5
+12VSB	13.3	14.5

**3.3.15.3 Over-temperature Protection (OTP)**

The power supply will be protected against over temperature conditions caused by loss of fan cooling or excessive ambient temperature. In an OTP condition the PSU will shut down. When the power supply temperature drops to within specified limits, the power supply shall restore power automatically, while the 12VSB remains always on. The OTP circuit must have built in margin such that the power supply will not



oscillate on and off due to temperature recovering condition. The OTP trip level shall have a minimum of 4°C of ambient temperature margin.

### 3.3.16 Power Supply Status LED

There is a single bi-color LED to indicate power supply status. The LED operation is defined in the following table.

**Table 16. LED Indicators**

Power Supply Condition	LED State
Output ON and OK	GREEN
No AC power to all power supplies	OFF
AC present / Only 12VSB on (PS off) or PS in Cold redundant state	1Hz Blink GREEN
AC cord unplugged or AC power lost; with a second power supply in parallel still with AC input power.	AMBER
Power supply warning events where the power supply continues to operate; high temp, high power, high current, slow fan.	1Hz Blink Amber
Power supply critical event causing a shutdown; failure, OCP, OVP, Fan Fail	AMBER
Power supply FW updating	2Hz Blink GREEN

## 3.4 DC Power Supply Input Specifications

The following sections provide the DC Input Specifications for systems configured with DC power supply modules.

---

**NOTE:** Product Safety Regulations pertaining to the use of DC power supplies require that chassis grounding studs be used for all DC power supply configurations. In the event that chassis grounding studs are not available on a given server chassis, systems must be configured with two DC power supplies, with each connected to separate ground wires while the system is operational.

---

### 3.4.1 DC Input Voltage

The power supply must operate within all specified limits over the following input voltage range.

**Table 17. DC Input Rating**

PARAMETER	MIN	RATED	MAX
DC Voltage	-40.5 VDC	-48VDC/-60VDC	-75VDC
Input Current	24A		12.5A

### 3.4.2 DC Input Fuse

The power supply shall have the -48VDC input fused. The fusing shall be acceptable for all safety agency requirements. DC inrush current shall not cause the fuse to blow under any conditions. No protection circuits in the power supply shall cause the DC fuse to blow unless a component in the power supply has failed. This includes DC output load short conditions.

### 3.4.3 DC Inrush Current

Maximum inrush current from power-on shall be limited to a level below the surge rating of the input line cable; input diodes, fuse, and EMI filter components. To allow multiple power cycling events and DC line transient conditions max  $I^2t$  value shall not exceed 20% of the fuse max rating. Repetitive ON/OFF cycling of the DC input line voltage should not damage the power supply or cause the input fuse to blow.

### 3.4.4 DC Input Under Voltage

The power supply shall contain protection circuitry (under-voltage lock-out) such that the application of an input voltage below the specified minimum specified, shall not cause damage (overstress) to the power supply unit (due to over-heating or otherwise).

### 3.4.5 DC Holdup Time and Dropout

Loading	Holdup time
750W (100%)	0.2msec

During a DC dropout of **0.2ms** or less the power supply must meet dynamic voltage regulation requirements for every rated load condition. A DC line dropout of 0.2ms or less shall not cause tripping of control signals or protection circuits. Repeated every **10 seconds** starting at the min input voltage DC line dropout shall not damage the power supply under any specified load conditions. The PWOK signal shall not go to a low state under these conditions. DC dropout transients in excess of 0.2 **milliseconds** may cause shutdown of the PS or out of regulation conditions, but shall not damage the power supply. The power supply should recover and meet all turn on requirements for DC dropouts that last longer than **0.2ms**. The power supply must meet the DC dropout requirement over rated DC voltages and output loading conditions.

### 3.4.6 DC Line Surge Voltages (Line Transients)

The Power Supply should demonstrate tolerance for transients in the input DC power line caused by switching or lightning. The power supply shall be primarily tested and must be compliant with the requirements of EN61000-4-5: "Electrical Fast transients / Burst Requirements and Surge Immunity Requirements" for surge withstand capability. The test voltage surge levels are to be: **500Vpk for each Line to Primary Earth Ground test (none required between the L1 and L2)**. The exact description can be found in Intel Environmental Standards Handbook 2001.

Table 18. Line Voltage Transient Limits

Duration	Slope/Rate	Output	Performance criteria
200µs max	-48V → -30V w/ +2V/µs	Rated DC Voltages	No loss of function or performance
	-30V → -48V w/ -2V/µs	Rated DC Voltages	No loss of function or performance

### 3.4.7 Susceptibility Requirements

The power supply shall meet the following electrical immunity requirements when connected to a cage with an external EMI filter which meets the criteria defined in the SSI document EPS Power Supply Specification. For further information on Intel standards please request a copy of the Intel Environmental Standards Handbook.

Level	Description
A	The apparatus shall continue to operate as intended. No degradation of performance.
B	The apparatus shall continue to operate as intended. No degradation of performance beyond spec limits.
C	Temporary loss of function is allowed provided the function is self-recoverable or can be restored by the operation of the controls.

#### 3.4.7.1 Electrostatic Discharge Susceptibility

The power supply shall comply with the limits defined in EN 55024: 1998 using the IEC 61000-4-2:1995 test standard and performance criteria B defined in Annex B of CISPR 24. Limits shall comply with those specified in the Intel Environmental Standards Handbook.

#### 3.4.7.2 Fast Transient/Burst

The power supply shall comply with the limits defined in EN55024: 1998 using the IEC 61000-4-4:1995 test standard and performance criteria B defined in Annex B of CISPR 24. Limits shall comply with those specified in the Intel Environmental Standards Handbook.

#### 3.4.7.3 Radiated Immunity

The power supply shall comply with the limits defined in EN55024: 1998 using the IEC 61000-4-3:1995 test standard and performance criteria A defined in Annex B of CISPR 24. Limits shall comply with those specified in the Intel Environmental Standards Handbook. Additionally, must also comply with field strength requirements specified in GR 1089 (10V/meter).

#### 3.4.7.4 Surge Immunity

The power supply shall be tested with the system for immunity, per EN 55024:1998, EN 61000-4-5:1995 and ANSI C62.45: 1992.

The pass criteria include: No unsafe operation is allowed under any condition; all power supply output voltage levels to stay within proper spec levels; no change in operating state or loss of data during and after the test profile; no component damage under any condition.

The power supply shall comply with the limits defined in EN55024: 1998 using the IEC 61000-4-5:1995 test standard and performance criteria B defined in Annex B of CISPR 24. Limits shall comply with those specified in the Intel Environmental Standards Handbook.

### 3.4.8 Protection Circuits

Protection circuits inside the power supply shall cause only the power supply's main outputs to shut down. If the power supply latches off due to a protection circuit tripping, a DC cycle OFF for 15sec and a PSON# cycle HIGH for 1sec shall be able to reset the power supply.

#### 3.4.8.1 Current Limit (OCP)

The power supply shall have current limit to prevent the outputs from exceeding the values shown in table below. If the current limits are exceeded the power supply shall shut down and latch off. The latch will be cleared by toggling the PSON# signal or by a DC power interruption. The power supply shall not be damaged from repeated power cycling in this condition. 12VSB will be auto-recovered after removing OCP limit.

**Table 19. Over Current Protection – 750 Watt Power Supply**

Output VOLTAGE	Input voltage range	OVER CURRENT LIMITS
+12V	90 – 264VAC	72A min; 78A max
12VSB	90 – 264VAC	2.5A min; 3.5A max

### 3.4.8.2 Over Voltage Protection (OVP)

The power supply over voltage protection shall be locally sensed. The power supply shall shutdown and latch off after an over voltage condition occurs. This latch shall be cleared by toggling the PSON# signal or by a DC power interruption. The values are measured at the output of the power supply's connectors. The voltage shall never exceed the maximum levels when measured at the power connectors of the power supply connector during any single point of fail. The voltage shall never trip any lower than the minimum levels when measured at the power connector. 12VSB will be auto-recovered after removing OVP limit.

**Table 20. Over Voltage Protection Limits – 750 Watt Power Supply**

Output Voltage	MIN (V)	MAX (V)
+12V	13.3	14.5
+12VSB	13.3	14.5

### 3.4.8.3 Over Temperature Protection (OTP)

The power supply will be protected against over temperature conditions caused by loss of fan cooling or excessive ambient temperature. In an OTP condition the PSU will shut down. When the power supply temperature drops to within specified limits, the power supply shall restore power automatically, while the 12VSB remains always on. The OTP circuit must have built in margin such that the power supply will not oscillate on and off due to temperature recovering condition. The OTP trip level shall have a minimum of 4°C of ambient temperature margin.

## 3.5 Cold Redundancy Support

The power supplies support cold redundancy allowing them to go into a low-power state (that is, cold redundant state) in order to provide increased power usage efficiency when system loads are such that both power supplies are not needed. When the power subsystem is in Cold Redundant mode, only the needed power supply to support the best power delivery efficiency is ON. Any additional power supplies; including the redundant power supply, is in Cold Standby state

Each power supply has an additional signal that is dedicated to supporting Cold Redundancy; CR\_BUS. This signal is a common bus between all power supplies in the system. CR\_BUS is asserted when there is a fault in any power supply OR the power supplies output voltage falls below the V<sub>fault</sub> threshold. Asserting the CR\_BUS signal causes all power supplies in Cold Standby state to power ON.

Enabling power supplies to maintain best efficiency is achieved by looking at the Load Share bus voltage and comparing it to a programmed voltage level via a PMBus command.

Whenever there is no active power supply on the Cold Redundancy bus driving a HIGH level on the bus all power supplies are ON no matter their defined Cold Redundant roll (active or Cold Standby). This guarantees that incorrect programming of the Cold Redundancy states of the power supply will never cause the power subsystem to shut down or become over loaded. The default state of the power subsystem is all power

supplies ON. There needs to be at least one power supply in Cold Redundant Active state or Standard Redundant state to allow the Cold Standby state power supplies to go into Cold Standby state.

### 3.5.1 Powering on Cold Standby supplies to maintain best efficiency

Power supplies in Cold Standby state shall monitor the shared voltage level of the load share signal to sense when it needs to power on. Depending upon which position (1, 2, or 3) the system defines that power supply to be in the cold standby configuration; will slightly change the load share threshold that the power supply shall power on at.

**Table 21. Example Load Share Threshold for Activating Supplies**

	Enable Threshold for $V_{CR\_ON\_EN}$	Disable Threshold for $V_{CR\_ON\_DIS}$	CR_BUS De-asserted / Asserted States
Standard Redundancy	NA; Ignore dc/dc_active# signal; power supply is always ON		OK = High Fault = Low
Cold Redundant Active	NA; Ignore dc/dc_active# signal; power supply is always ON		OK = High Fault = Low
Cold Standby 1 (02h)	3.2V (40% of max)	$3.2V \times 0.5 \times 0.9 = 1.44V$	OK = Open Fault = Low
Cold Standby 2 (03h)	5.0V (62% of max)	$5.0V \times 0.67 \times 0.9 = 3.01V$	OK = Open Fault = Low
Cold Standby 3 (04h)	6.7V (84% of max)	$6.7V \times 0.75 \times 0.9 = 4.52V$	OK = Open Fault = Low

Notes:

1. Maximum load share voltage = 8.0V at 100% of rated output power
2. These are example load share bus thresholds; for a given power supply, these shall be customized to maintain the best efficiency curve for that specific model.

### 3.5.2 Powering on Cold Standby Supplies during a Fault or Over Current Condition

When an active power supply asserts its CR\_BUS signal (pulling it low), all parallel power supplies in cold standby mode shall power on within 100µsec.

### 3.5.3 BMC Requirements

The BMC uses the Cold\_Redundancy\_Config command to define or configure the power supply's roll in cold redundancy and to turn on/off cold redundancy.

The BMC shall schedule a rolling change for which PSU is the Active, Cold Stby1, Cold Stby 2, and Cold Stby 3 power supply. This allows for equal loading across power supply over their life.

Events that trigger a re-configuration of the power supplies using the Cold\_Redundancy\_Config command.

- AC power ON
- PSON power ON
- Power Supply Failure
- Power supply inserted into system

### 3.5.4 Power Supply Turn On Function

Powering on and off of the cold standby power supplies is only controlled by each PSU sensing the Vshare bus. Once a power supply turns on after crossing the enable threshold; it lowers its threshold to the disable threshold. The system defines the "position" of each power supply in the Cold Redundant operation. It will do this each time the system is powered on, a power supply fails, or a power supply is added to the system.

The system is relied upon to tell each power supply where it resides in the Cold Redundancy scheme.

### 3.6 Closed Loop System Throttling (CLST)

The server system has support for Closed Loop System Throttling (CLST). CLST prevents the system from crashing if a power supply module is overloaded or insufficient cooled. Should system power reach a pre-programmed power limit or power supply thermal sensor hit the threshold, CLST will throttle system memory and/or processors to reduce power. System performance will be impacted should this occur.

### 3.7 Smart Ride Through (SmaRT)

The server system has support for Smart Ride through Throttling (SmaRT). This feature increases the reliability for a system operating in a heavy power load condition, to remain operational during an AC line dropout event. See section *AC Line Dropout / Holdup* for power supply hold up time requirements for AC Line dropout events.

When AC voltage is too low, a fast AC loss detection circuit inside each installed power supply asserts an SMBALERT# signal to initiate a throttle condition in the system. System throttling reduces the bandwidth to both system memory and CPUs, which in turn reduces the power load during the AC line drop out event.

### 3.8 Server Board Power Connectors

The server board provides several connectors to provide power to various system options. The following sub-sections will provide the pin-out definition; and a brief usage description for each.

#### 3.8.1 Power Supply Module Card Edge Connector

Each power supply module has a single 2x25 card edge output connection that plugs directly into a matching slot connector on the server board. The connector provides both power and communication signals to the server board. The following table defines the connector pin-out.

**Table 22. Power Supply Module Output Power Connector Pin-out**

Pin	Name	Pin	Name
A1	GND	B1	GND
A2	GND	B2	GND
A3	GND	B3	GND
A4	GND	B4	GND
A5	GND	B5	GND
A6	GND	B6	GND
A7	GND	B7	GND
A8	GND	B8	GND
A9	GND	B9	GND
A10	+12V	B10	+12V
A11	+12V	B11	+12V
A12	+12V	B12	+12V
A13	+12V	B13	+12V
A14	+12V	B14	+12V
A15	+12V	B15	+12V
A16	+12V	B16	+12V
A17	+12V	B17	+12V
A18	+12V	B18	+12V
A19	PMBus SDA	B19	A0 (SMBus address)

## Intel® Server System R1000WT Family TPS

Pin	Name	Pin	Name
A20	PMBus SCL	B20	A1 (SMBus address)
A21	PSON	B21	12V stby
A22	SMBAlert#	B22	Cold Redundancy Bus
A23	Return Sense	B23	12V load share bus
A24	+12V remote Sense	B24	No Connect
A25	PWOK	B25	Compatibility Check pin*

### 3.8.2 Hot Swap Backplane Power Connector

The server board includes one white 2x4-pin power connector that is cabled to provide power for hot swap backplanes. On the server board, this connector is labeled as “HSBP PWR”. The following table provides the pin-out for this connector.

**Table 23. Hot Swap Backplane Power Connector Pin-out (“HSBP PWR”)**

Signal Description	Pin#	Pin#	Signal Description
P12V_240VA	5	1	GROUND
P12V_240VA	6	2	GROUND
P12V_240VA	7	3	GROUND
P12V_240VA	8	4	GROUND

### 3.8.3 Optical Drive and SSD Power Connector

The server board includes one brown 2x3-pin power connector intended to provide power to optionally installed optical drive. On the server board this connector is labeled as “Peripheral PWR”. The following table provides the pin-out for this connector.

**Table 24. Peripheral Drive Power Connector Pin-out (“Peripheral PWR”)**

Signal Description	Pin#	Pin#	Signal Description
P12V	4	1	P5V
P3V3	5	2	P5V
GROUND	6	3	GROUND

## 4. Thermal Management

The fully integrated system is designed to operate at external ambient temperatures of between 10°C and 35°C with limited excursion based operation up to 45°C, as specified in *Table 2. System Environmental Limits Summary*. Working with integrated platform management, several features within the system are designed to move air in a front to back direction, through the system and over critical components to prevent them from overheating and allow the system to operate with best performance.

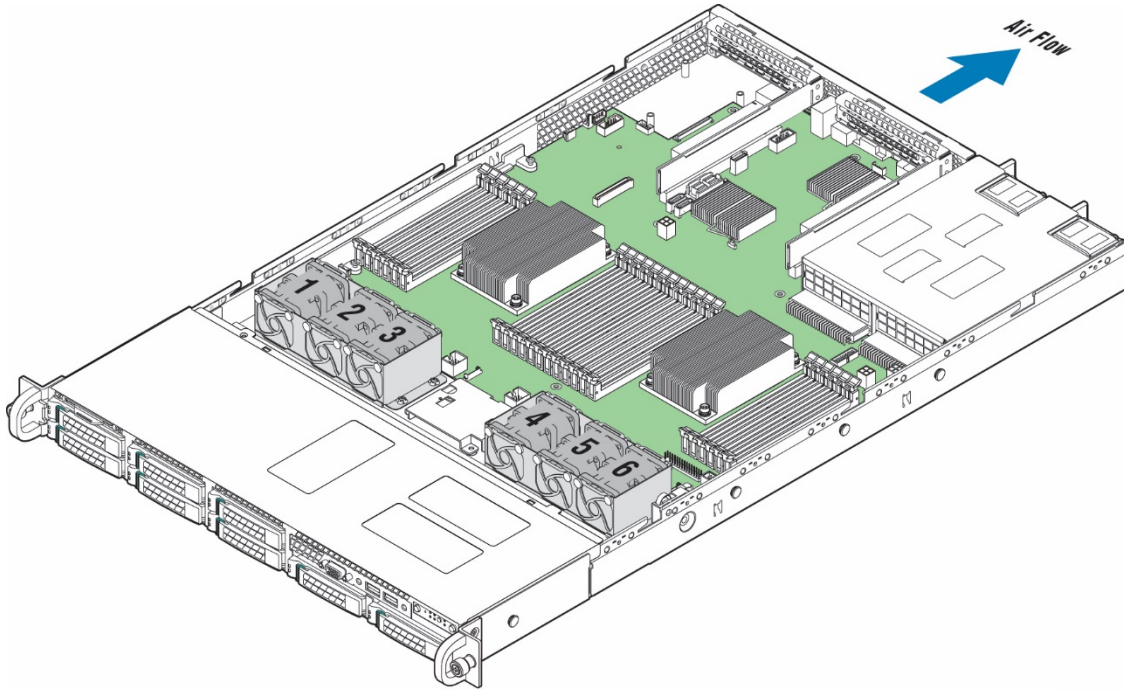

AF006260

**Figure 25. System Air Flow and Fan Identification**

The following tables provide air flow data associated with the different system models within this 1U product family, and are provided for reference purposes only. The data was derived from actual wind tunnel test methods and measurements using fully configured (worst case) system configurations. Lesser system configurations may produce slightly different data results. In addition, the CFM data was derived using server management utilities that utilize platform sensor data, and may vary slightly from the data listed in the tables.

**Table 25. System Volumetric Air Flow**

System airflow – R1304WTxxxx			System airflow – R1208WTxxxx		
System Fan	PSU Fan	Total Airflow (CFM)	System Fan	PSU Fan	Total Airflow (CFM)
100%	auto	85.6	100%	auto	89.0
80%	auto	67.7	80%	auto	69.6
60%	auto	48.9	60%	auto	50.8
40%	auto	31.6	40%	auto	32.6
20%	auto	13.6	20%	auto	13.8
100%	100%	89.1	100%	100%	92.6



The Intel® Server System R1000WT product family supports short-term, excursion-based, operation up to 45°C (ASHRAE A4) with limited performance impact. The configuration requirements and limitations are described in the configuration matrix found in Appendix D of this document or in the *Intel® Server Board S2600WT Product Family Power Budget and Thermal Configuration Tool*, available as a download online at <http://www.intel.com/support>

The installation and functionality of several system components are used to maintain system thermals. They include six managed 40mm dual rotor system fans, fans integrated into each installed power supply module, an air duct, populated drive carriers, and installed CPU heatsinks. Drive carriers can be populated with a storage device (SSD or Hard Disk Drive) or supplied drive blank. In addition, it may be necessary to have specific DIMM slots populated with DIMMs or supplied DIMM blanks. Systems configurations that require population of specific DIMM slots will ship from Intel with DIMM blanks pre-installed. Pre-installed DIMM blanks should only be removed when installing a memory module in its place.

### 4.1 Thermal Operation and Configuration Requirements

To keep the system operating within supported maximum thermal limits, the system must meet the following operating and configuration guidelines:

- The system operating ambient is designed for sustained operation up to 35°C (ASHRAE Class A2) with short term excursion based operation up to 45°C (ASHRAE Class A4).
  - The system can operate up to 40°C (ASHRAE Class A3) for up to 900 hours per year
  - The system can operate up to 45°C (ASHRAE Class A4) for up to 90 hours per year
  - System performance may be impacted when operating within the extended operating temperature range
  - There is no long term system reliability impact when operating at the extended temperature range within the documented limits.
- Specific configuration requirements and limitations are documented in the configuration matrix found in Appendix D of this document or in the *Intel® Server Board S2600WT product family Power Budget and Thermal Configuration Tool*, available as a download online at <http://www.intel.com/support>
- The CPU-1 processor + CPU heat sink must be installed first. The CPU-2 heat sink must be installed at all times, with or without a processor installed
- Thermally, a system supporting fan redundancy can support the following PCI add-in cards when the system is operating at a maximum operating ambient temperature of 35°C (ASHRAE Class 2).
  - Add-in cards with a minimum 300 LFM (1.5 m/s) air flow requirement or lower can be installed in available add-in card slots in Riser Card #1 and Riser Card #2
  - Add-in cards with an air flow requirement greater than 300 LFM cannot be supported in any PCIe slot on any riser
  - **Note:** Most PCI add-in cards have minimum air flow requirements of 100 LFM (0.5m/s). Some high power add-in cards have minimum air flow requirements of 300 LFM (1.5 m/s) or higher. System integrators should verify PCI add-in card air flow requirements from vendor specifications when integrating add-in cards into the system.

- **Memory Slot population requirements –**
- NOTE: Some system configurations may come with pre-installed DIMM blanks in some memory slots. DIMM blanks should only be removed when installing a DIMM in the same DIMM slot. Memory population rules apply when installing DIMMs
  - **DIMM Population Rules on CPU-1** – Install DIMMs in order; Channels A, B, C, and D. Start with the 1<sup>st</sup> DIMM (Blue Slot) on each channel, then slot 2, then slot 3. Only remove factory installed DIMM blanks when populating the slot with memory
  - **DIMM Population Rules on CPU-2** – Install DIMMs in order; Channels E, F, G, and H. Start with the 1<sup>st</sup> DIMM (Blue Slot) on each channel, then slot 2, then slot 3. Only remove factory installed DIMM blanks when populating the slot with memory
  - The 3<sup>rd</sup> DIMM slot for each memory channel must be populated with a DIMM or supplied DIMM blank for all R1304WTxxx and R1208WTxxx based system configurations
- All externally accessed drive bays must be populated. Drive carriers can be populated with a storage device (SSD or HDD) or supplied drive blank
- With the system operating, the air duct must be installed at all times
- In single power supply configurations, the 2<sup>nd</sup> power supply bay must have the supplied filler blank installed at all times
- The system must be configured with dual power supplies for the system to support system fan redundancy
- Fan redundancy is lost if more than one system fan rotor is in a failed state
- System fan redundancy is not supported with systems operating at ASHRAE A3 or A4 thermal limits
- The system top cover must be installed at all times when the system is in operation

## 4.2 Thermal Management Overview

In order to maintain the necessary airflow within the system, all of the previously listed components and top cover need to be properly installed. For best system performance, the external ambient temperature should remain below 35°C and all system fans (all rotors) should be operational. The system is designed for fan redundancy when the system is configured with two power supplies, all system fans are present and operational, and ambient air remains at or below ASHRAE class 2 limits (See table 2). In fan redundancy mode, should a single system fan rotor failure occur, integrated platform management will: change the state of the System Status LED to flashing Green, report an error to the system event log, and automatically adjust remaining fan speeds as needed to maintain system temperatures below maximum thermal limits.

**Note:** All system fans are controlled independent of each other. The fan control system may adjust fan speeds for different fans based on increasing/decreasing temperatures in different thermal zones within the chassis.

In the event that system temperatures should continue to increase with the system fans operating at their maximum speed, platform management may begin to throttle bandwidth of either the memory subsystem or the processors or both, in order to keep components from overheating and keep the system operational. Throttling of these subsystems will continue until system temperatures are reduced below preprogrammed limits.

The power supply will be protected against over temperature conditions caused by excessive ambient temperature. In an over-temperature protection condition, the power supply module will shut down.

Should system thermals increase to a point beyond the maximum thermal limits, the system will shut down, the System Status LED will change to a solid Amber state, and the event will be logged to the system event log. Should power supply thermals increase to a point beyond its maximum thermal limit or if a power supply fan should fail, the power supply will shut down.

---

**Note:** For proper system thermal management, Sensor Data Records (SDRs) for any given system configuration must be loaded by the system integrator as part of the initial system integration process. SDRs are loaded using the FRUSDR utility which is part of the System Update Package (SUP) or One-boot Firmware Update (OFU) package which can be downloaded from the following Intel website:

<http://downloadcenter.intel.com>

---

#### 4.2.1 Fan Speed Control

The baseboard management controller (BMC) controls and monitors the system fans. Each fan is associated with a fan speed sensor that detects fan failure. For redundant fan configurations, the fan failure and presence status determines the fan redundancy sensor state.

The system fans are divided into fan domains, each of which has a separate fan speed control signal and a separate configurable fan control policy. A fan domain can have a set of temperature and fan sensors associated with it. These are used to determine the current fan domain state.

A fan domain has three states:

- The sleep and boost states have fixed (but configurable through OEM SDRs) fan speeds associated with them
- The nominal state has a variable speed determined by the fan domain policy. An OEM SDR record is used to configure the fan domain policy

The fan domain state is controlled by several factors. They are listed below in order of precedence, high to low:

- Boost
  - Associated fan is in a critical state or missing. The SDR describes which fan domains are boosted in response to a fan failure or removal in each domain. If a fan is removed when the system is in 'Fans-off' mode it will not be detected and there will not be any fan boost till system comes out of 'Fans-off; mode.
  - Any associated temperature sensor is in a critical state. The SDR describes which temperature threshold violations cause fan boost for each fan domain.
  - The BMC is in firmware update mode, or the operational firmware is corrupted.
  - If any of the above conditions apply, the fans are set to a fixed boost state speed.
- Nominal
  - A fan domain's nominal fan speed can be configured as static (fixed value) or controlled by the state of one or more associated temperature sensors.

##### 4.2.1.1 Programmable Fan PWM Offset

The system provides a BIOS Setup option to boost the system fan speed by a programmable positive offset or a "Max" setting. Setting the programmable offset causes the BMC to add the offset to the fan speeds to which it would otherwise be driving the fans. The Max setting causes the BMC to replace the domain minimum speed with alternate domain minimums that also are programmable through SDRs.

This capability is offered to provide system administrators the option to manually configure fan speeds in instances where the fan speed optimized for a given platform may not be sufficient when a high end add-in adapter is configured into the system. This enables easier usage of the fan speed control to support Intel as well as third party chassis and better support of ambient temperatures higher than 35°C.

#### **4.2.1.2 Fan Redundancy Detection**

The BMC supports redundant fan monitoring and implements a fan redundancy sensor. A fan redundancy sensor generates events when it is associated set of fans transitions between redundant and non-redundant states, as determined by the number and health of the fans. The definition of fan redundancy is configuration dependent. The BMC allows redundancy to be configured on a per fan redundancy sensor basis through OEM SDR records.

A fan failure up to the number of redundant fans specified in the SDR in a fan configuration is a non-critical failure and is reflected in the front panel status. A fan failure or removal that exceeds the number of redundant fans is a non-fatal, insufficient-resources condition and is reflected in the front panel status as a non-fatal error.

Redundancy is checked only when the system is in the DC-on state. Fan redundancy changes that occur when the system is DC-off or when AC is removed will not be logged until the system is turned on.

#### **4.2.1.3 Fan Domains**

System fan speeds are controlled through pulse width modulation (PWM) signals, which are driven separately for each domain by integrated PWM hardware. Fan speed is changed by adjusting the duty cycle, which is the percentage of time the signal is driven high in each pulse.

The BMC controls the average duty cycle of each PWM signal through direct manipulation of the integrated PWM control registers.

The same device may drive multiple PWM signals.

#### **4.2.1.4 Nominal Fan Speed**

A fan domain's nominal fan speed can be configured as static (fixed value) or controlled by the state of one or more associated temperature sensors.

OEM SDR records are used to configure which temperature sensors are associated with which fan control domains and the algorithmic relationship between the temperature and fan speed. Multiple OEM SDRs can reference or control the same fan control domain; and multiple OEM SDRs can reference the same temperature sensors.

The PWM duty-cycle value for a domain is computed as a percentage using one or more instances of a stepwise linear algorithm and a clamp algorithm. The transition from one computed nominal fan speed (PWM value) to another is ramped over time to minimize audible transitions. The ramp rate is configurable by means of the OEM SDR.

Multiple stepwise linear and clamp controls can be defined for each fan domain and used simultaneously. For each domain, the BMC uses the maximum of the domain's stepwise linear control contributions and the sum of the domain's clamp control contributions to compute the domain's PWM value, except that a stepwise linear instance can be configured to provide the domain maximum.

Hysteresis can be specified to minimize fan speed oscillation and to smooth fan speed transitions. If a Tcontrol SDR record does not contain a hysteresis definition, for example, an SDR adhering to a legacy format, the BMC assumes a hysteresis value of zero.

#### 4.2.1.5 Thermal and Acoustic Management

This feature refers to enhanced fan management to keep the system optimally cooled while reducing the amount of noise generated by the system fans. Aggressive acoustics standards might require a trade-off between fan speed and system performance parameters that contribute to the cooling requirements and primarily memory bandwidth. The BIOS, BMC, and SDRs work together to provide control over how this trade-off is determined.

This capability requires the BMC to access temperature sensors on the individual memory DIMMs. Additionally, closed-loop thermal throttling is only supported with buffered DIMMs.

#### 4.2.1.6 Thermal Sensor Input to Fan Speed Control

The BMC uses various IPMI sensors as input to the fan speed control. Some of the sensors are IPMI models of actual physical sensors whereas some are “virtual” sensors whose values are derived from physical sensors using calculations and/or tabular information.

The following IPMI thermal sensors are used as input to fan speed control:

- Front Panel Temperature Sensor<sup>1</sup>
- CPU Margin Sensors<sup>2,4,5</sup>
- DIMM Thermal Margin Sensors<sup>2,4</sup>
- Exit Air Temperature Sensor<sup>1,7,9</sup>
- PCH Temperature Sensor<sup>3,5</sup>
- On-board Ethernet Controller Temperature Sensors<sup>3,5</sup>
- Add-In Intel SAS Module Temperature Sensors<sup>3,5</sup>
- PSU Thermal Sensor<sup>3,8</sup>
- CPU VR Temperature Sensors<sup>3,6</sup>
- DIMM VR Temperature Sensors<sup>3,6</sup>
- BMC Temperature Sensor<sup>3,6</sup>
- Global Aggregate Thermal Margin Sensors<sup>7</sup>
- Hot Swap Backplane Temperature Sensors
- I/O Module Temperature Sensor (With option installed)
- Intel® SAS Module (With option installed)
- Riser Card Temperature Sensors (2U system only)
- Intel® Xeon Phi™ coprocessor (2U system only with option installed)

#### Notes:

1. For fan speed control in Intel chassis
2. Temperature margin from throttling threshold
3. Absolute temperature
4. PECL value or margin value
5. On-die sensor
6. On-board sensor
7. Virtual sensor
8. Available only when PSU has PMBus
9. Calculated estimate

A simple model is shown in the following figure which gives a high level representation of how the fan speed control structure creates the resulting fan speeds

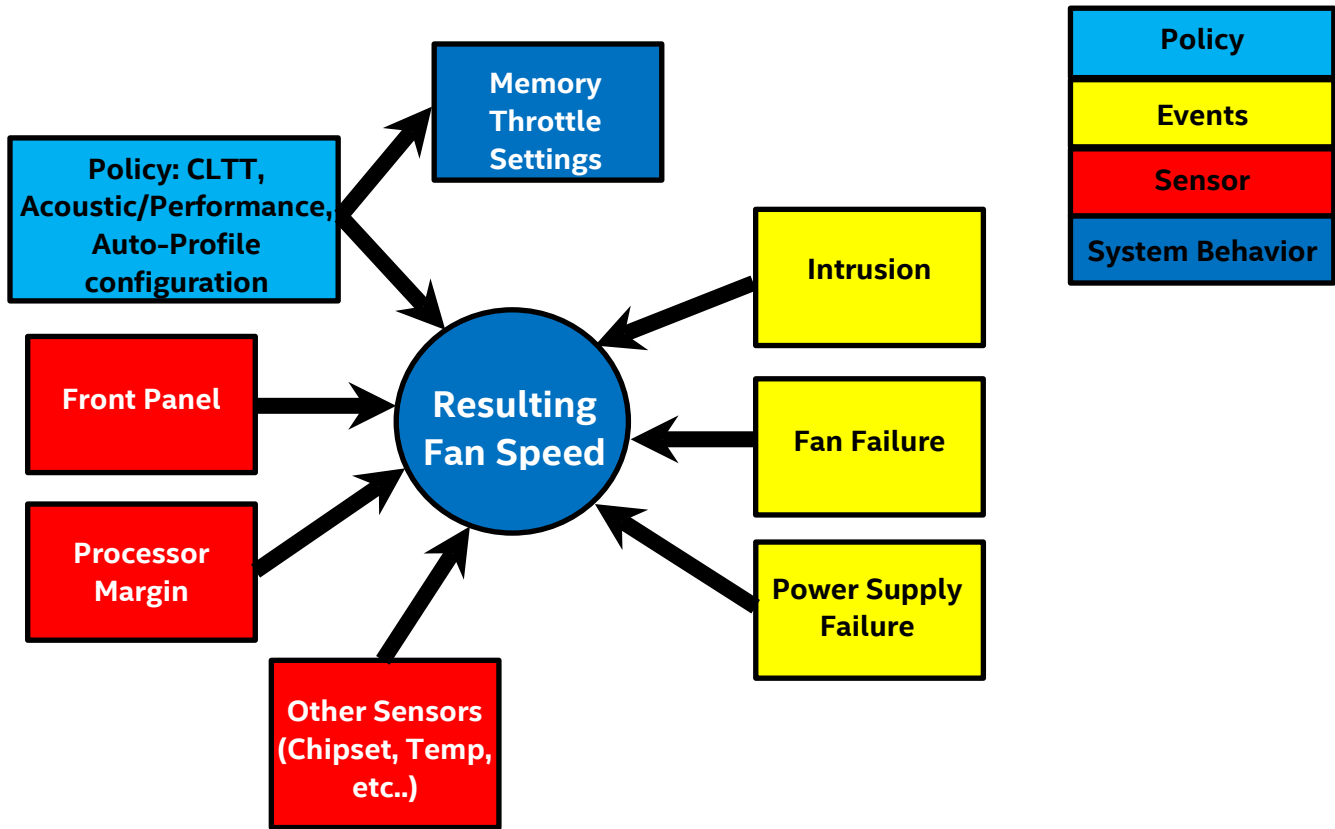

Figure 26. Fan Control Model

### 4.3 System Fans

Six dual rotor 40 x 56mm system fans and an embedded fan for each installed power supply provide the primary airflow for the system.

The system is designed for fan redundancy when configured with two power supply modules, all system fan rotors are operational, and ambient air remains at or below ASHRAE class 2 limits (See table 2). Should a single system fan rotor fail, platform management will adjust air flow of the remaining system fans and manage other platform features to maintain system thermals. Fan redundancy is lost if more than one system fan rotor is in a failed state.

The system includes two system fan assemblies (three dual rotor fans each). The fan assemblies are held in place by fitting them over mounting pins coming up from the chassis base.

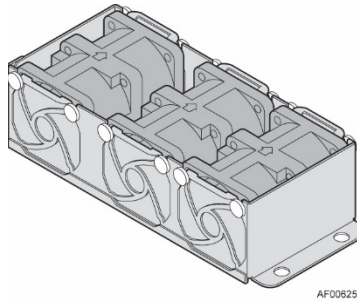

**Figure 27. System Fan Assembly**

- System fans are NOT hot-swappable
- Each fan and fan assembly is designed for tool-less insertion and extraction from the system. For instructions on fan replacement, see the *Intel® Server System R1000WT System Integration and Service Guide*
- Each fan and fan assembly incorporates vibration dampening features used to minimize fan vibration affects within the chassis
- Fan speed for each fan is controlled by integrated platform management as controlled by the integrated BMC on the server board. As system thermals fluctuate high and low, the integrated BMC firmware will increase and decrease the speeds to specific fans to regulate system thermals.
- Each fan has a tachometer signal for each rotor that allows the Integrated BMC to monitor their status.
- Each system fan includes a fault LED located near each system fan connector on the server board
- Each fan has a 10-pin wire harness that connects to a matching connector on the server board.

On the server board , each system fan includes a pair of fan connectors; a 1x10 pin connector to support a dual rotor cabled fan, typically used in 1U system configurations, and a 2x3 pin connector to support a single rotor hot swap fan assembly, typically used in 2U system configurations. Concurrent use of both fan connector types for any given system fan pair is not supported.

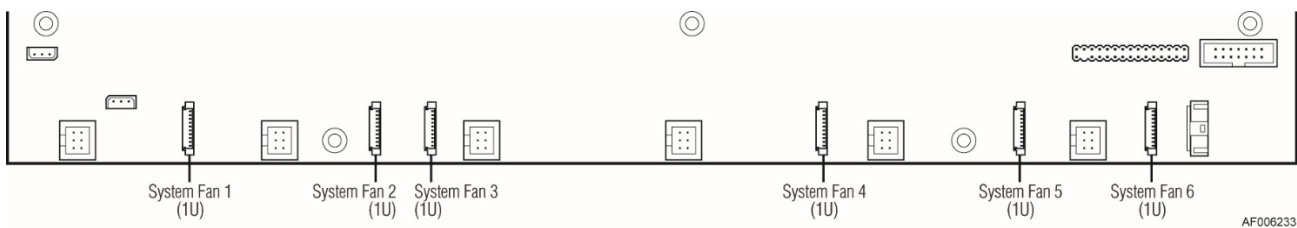

**Figure 28. System Fan Connector Locations on Server Board**

Table 26. System Fan Connector Pin-out

SYS_FAN 1		SYS_FAN 2		SYS_FAN 3	
Signal Description	Pin#	Signal Description	Pin#	Signal Description	Pin#
FAN_TACH1	1	FAN_TACH3	1	FAN_TACH5	1
FAN_PWM0	2	FAN_PWM1	2	FAN_PWM2	2
P12V_CPU_DIMM	3	P12V_CPU_DIMM	3	P12V_CPU_DIMM	3
P12V_CPU_DIMM	4	P12V_CPU_DIMM	4	P12V_CPU_DIMM	4
FAN_TACH0	5	FAN_TACH2	5	FAN_TACH4	5
GROUND	6	GROUND	6	GROUND	6
GROUND	7	GROUND	7	GROUND	7
FM_SYS_FAN0_PRSENT_N	8	FM_SYS_FAN1_PRSENT_N	8	FM_SYS_FAN2_PRSENT_N	8
LED_FAN_FAULT0_R	9	LED_FAN_FAULT1_R	9	LED_FAN_FAULT2_R	9
LED_FAN0	10	LED_FAN1	10	LED_FAN2	10
SYS_FAN 4		SYS_FAN 5		SYS_FAN 6	
Signal Description	Pin#	Signal Description	Pin#	Signal Description	Pin#
FAN_TACH7	1	FAN_TACH9	1	FAN_TACH11	1
FAN_PWM3	2	FAN_PWM4	2	FAN_PWM5	2
P12V_CPU_DIMM	3	P12V_CPU_DIMM	3	P12V_CPU_DIMM	3
P12V_CPU_DIMM	4	P12V_CPU_DIMM	4	P12V_CPU_DIMM	4
FAN_TACH6	5	FAN_TACH8	5	FAN_TACH10	5
GROUND	6	GROUND	6	GROUND	6
GROUND	7	GROUND	7	GROUND	7
FM_SYS_FAN3_PRSENT_N	8	FM_SYS_FAN4_PRSENT_N	8	FM_SYS_FAN5_PRSENT_N	8
LED_FAN_FAULT3_R	9	LED_FAN_FAULT4_R	9	LED_FAN_FAULT5_R	9
LED_FAN3	10	LED_FAN4	10	LED_FAN5	10

## 4.4 Power Supply Module Fans

Each installed power supply module includes embedded (non-removable) 40-mm fans. They are responsible for airflow through the power supply module. These fans are managed by the fan control system. Should a fan fail, the power supply will shut down.

## 4.5 FRUSDR Utility

The purpose of the embedded platform management and fan control systems is to monitor and control various system features, and to maintain an efficient operating environment. Platform management is also used to communicate system health to supported platform management software and support mechanisms. The FRUSDR utility is used to program the server board with platform specific environmental limits, configuration data, and the appropriate sensor data records (SDRs), for use by these management features.

The FRUSDR utility must be run as part of the initial platform integration process before it is deployed into a live operating environment. Once the initial FRU and SDR data is loaded on to the system, all subsequent system configuration changes will automatically update SDR data using the BMC auto configuration feature, without having to run the FRUSDR utility again. However, to ensure the latest sensor data is installed, the SDR data should be updated to the latest available as part of a planned system software update.



## Intel® Server System R1000WT Family TPS

The FRUSDR utility for the given server platform can be downloaded as part of the System Update Package (SUP) or One-boot Firmware Update (OFU) package from the following Intel web site:

<http://downloadcenter.intel.com>

---

**Note:** The embedded platform management system may not operate as expected if the platform is not updated with accurate system configuration data. The FRUSDR utility must be run with the system fully configured during the initial system integration process for accurate system monitoring and event reporting.

---

## 5. System Storage and Peripheral Drive Bay Overview

The Intel® Server System R1000WT product family has support for a variety of different storage options, including:

- Up to 8 x 2.5" hot swap SAS or SATA drives (hard disk or SSD)
- Up to 4 x 3.5" hot swap SAS or SATA hard disk drives or 2.5" SSDs
- Accessory Kit option to support up to 4 PCIe\* SFF (NVMe) SSDs + up to 4 x 2.5" SAS drives (hard disk or SSD)
- SATA Slim-line Optical Drive support
- Up to 2 internally mounted SATA DOMs
- Internally mounted Low Profile (2mm) eUSB Solid State Device (eUSB SSD)

Support for different storage and peripheral options will vary depending on the system model and/or available accessory options installed. This section will provide an overview of each available option.

### 5.1 Front Mount Drive Support

The 1U product family provides options to support either 8x2.5" or 4x3.5" front mounted drives. Both system options provide front panel I/O and front control panel support.

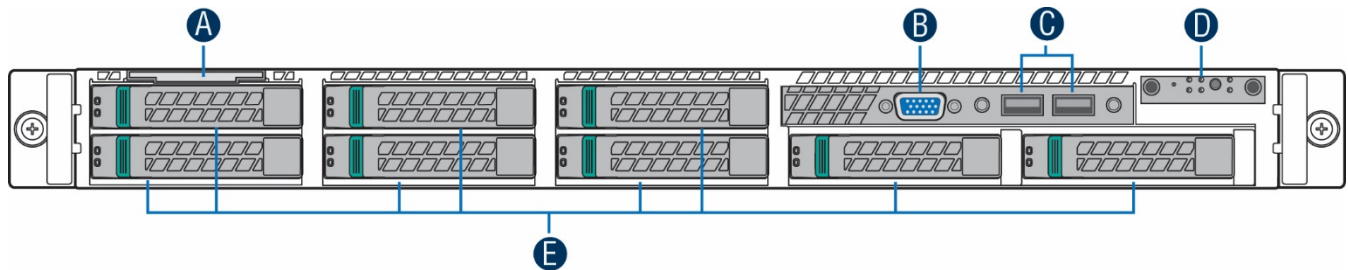

AF006317

Label	Description
A	System Label Pull-out
B	Video Connector
C	USB 3.0 Ports
D	Front Control Panel
E	2.5" Drive Bays

Figure 29. 8x2.5" Drive Bay Configuration (Model R1208xxxxx)

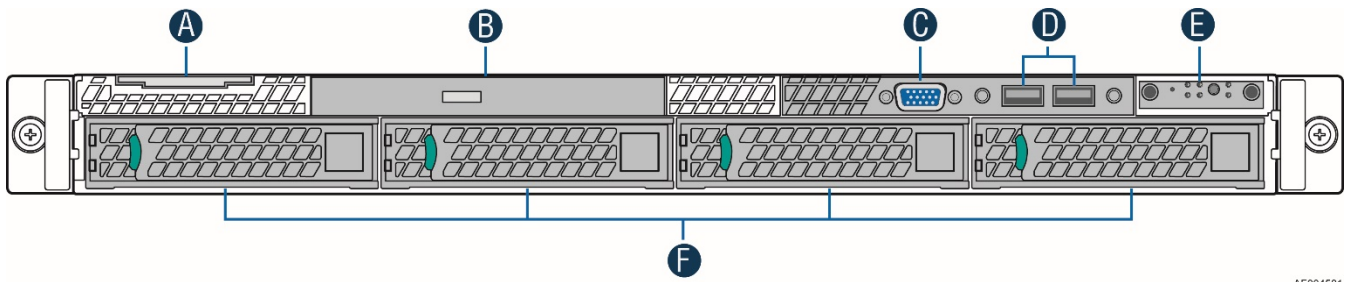

AF004581

Label	Description
A	System Label Pull-out Tab
B	SATA Optical Drive
C	Video Connector
D	USB 3.0 Ports
E	Front Control Panel
F	3.5" Drive Bays

Figure 30. 4x3.5" Drive Bay Configuration (Model R1304WTxxxx)

## 5.2 System Fan RVI and Hard Disk Drive Storage Performance

Hard disk drive storage technology, which utilizes the latest state-of-the-art track density architectures, are susceptible to the effects of system fan rotational vibration interference (RVI) within the server system. As system fan speeds increase to their upper limits (>80% PWM or > 19,320 RPM), hard disk drive performance can be impacted.

Intel publishes a list of supported hard drives on its Tested Hardware and OS List (THOL). In general, unless identified in the NOTES column in the THOL, all listed hard drives have been tested to meet Intel performance targets when the systems fans are operating above 80% PWM and/or the system is operating at or below the platform ambient thermal limit of 35°C (95°F).

The THOL may also list hard drives that are only recommended for use in non-extreme operating environments, where the ambient air is at or below 20°C (68°F) and /or the hard drives are installed in system configurations where the system fans regularly operate below 80% PWM. Hard drives that require these support criteria for a given system will include an "Environmental Limitation" tag and message in the THOL "NOTES" column for that device. Using these drives in the more extreme operating environments puts these devices at higher risk of performance degradation.

Intel recommends the following general support guidelines for server systems configured with hard drive storage technology:

- Avoid sustained server operation in extreme operating environments. Doing so will cause the system fans to operate at their upper speed limits and produce higher levels of RVI which could affect hard drive performance.

Note: Solid State Drive (SSD) performance is not impacted by the effects of system fan RVI.

### 5.3 Hot Swap Storage Device Carriers

Each SAS/SATA hard disk drive or SSD that interfaces with a backplane is mounted to a hot swap drive carrier. Drive carriers include a latching mechanism used to assist with drive extraction and drive insertion.

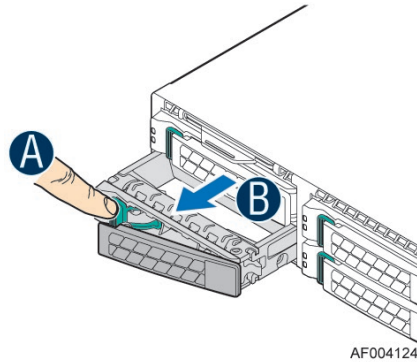

---

**Note:** To ensure proper system air flow requirements, all front drive bays must be populated with a drive tray. Drive trays must be installed with either a drive or supplied drive blank.

---

There are drive carriers to support 2.5" devices and 3.5" devices. To maintain system thermals, all drive bays must be populated with a drive carrier mounted with a hard disk drive, SSD, or supplied drive blank. Drive blanks used with the 3.5" drive carrier can also be used to mount a 2.5" SSD into it as shown below.

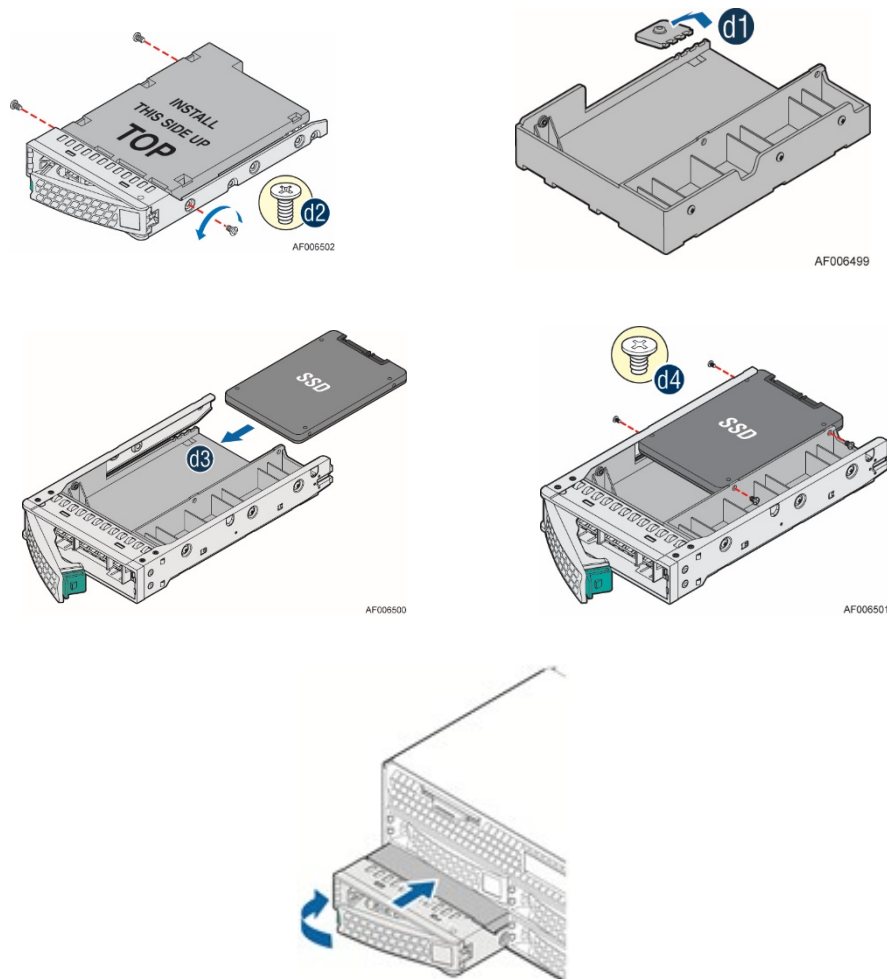

Figure 31. 2.5" SSD mounted to 3.5" Drive Tray

**Note:** Due to degraded performance and reliability concerns, the use of the 3.5" drive blank as a 2.5" device bracket is intended to support SSD type storage devices only. Installing a 2.5" hard disk drive into the 3.5" drive blank cannot be supported.

Each drive carrier includes separate LED indicators for drive Activity and drive Status. Light pipes integrated into the drive carrier assembly direct light emitted from LEDs mounted next to each drive connector on the backplane to the drive carrier faceplate, making them visible from the front of the system.

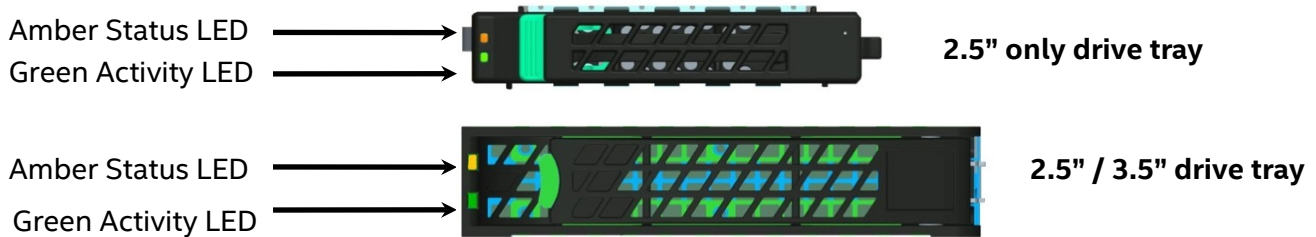

Figure 32. Drive Tray LED Identification

Table 27. Drive Status LED States

<b>Amber</b>	Off	No access and no fault
	Solid On	Hard Drive Fault has occurred
	Blink	RAID rebuild in progress (1 Hz), Identify (2 Hz)

Table 28. Drive Activity LED States

	Condition	Drive Type	Behavior
<b>Green</b>	Power on with no drive activity	SAS	LED stays on
		SATA	LED stays off
	Power on with drive activity	SAS	LED blinks off when processing a command
		SATA	LED blinks on when processing a command
	Power on and drive spun down	SAS	LED stays off
		SATA	LED stays off
Power on and drive spinning up	SAS	LED blinks	
	SATA	LED stays off	

**Note:** The drive activity LED is driven by signals coming from the drive itself. Drive vendors may choose to operate the activity LED different from what is described in the table above. Should the activity LED on a given drive type behave differently than what is described, customers should reference the drive vendor specifications for the specific drive model to determine what the expected drive activity LED operation should be.

## 5.4 Peripheral Power Sources

Power for all backplanes and peripheral storage devices is drawn from two power connectors labeled as “HSBP\_PWR” and “Peripheral\_PWR” on the server board as illustrated below.

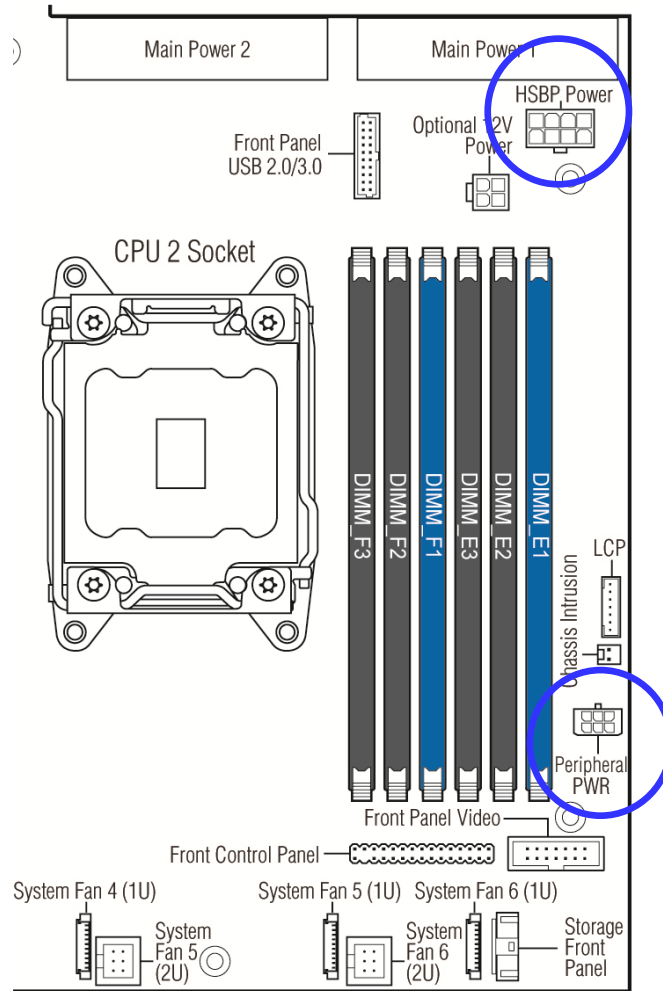

**Figure 33. Server Board Peripheral Power Connectors**

**HSBP Power** – The hot swap backplane power connector provides power for all front mounted backplane options. Appropriate power cables to support any given backplane option will be included with the given system model or given backplane accessory kit. See Table 21. Hot Swap Backplane Power Connector Pin-out (“HSBP PWR”).

**Peripheral Power** – The “Peripheral\_PWR” connector is used to provide power to the optical SATA drive. Depending on the system model, the system will ship with a peripheral power cable compatible with the devices supported for the given system. See Table 22. Peripheral Drive Power Connector Pin-out (“Peripheral PWR”).

## 5.5 Optical Drive Support

Systems configured with four 3.5" drive bays also include support for an optical drive bay 'A' as illustrated below.

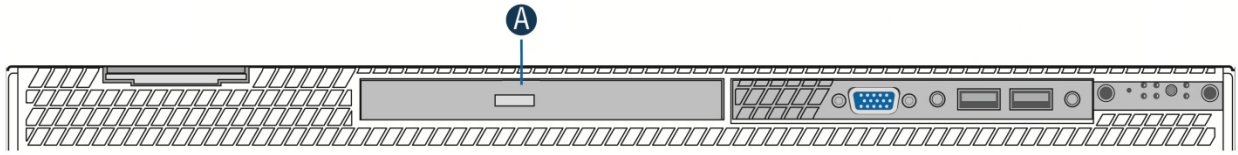

**Figure 34. Optical Drive Support**

For systems that support eight 2.5" hard drives, the front I/O Panel, which provides video and USB ports, can be replaced with a SATA optical drive.

A 2x3 pin power connector labeled "Peripheral\_PWR" on the server board is designed to provide power to the SATA optical drive. SATA signals for the optical drive are cabled from one of the two white single port SATA connectors on the server board.

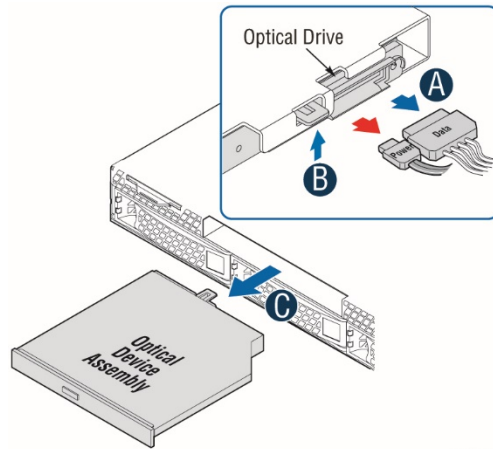

AF004384

**Figure 35. Optical Drive Installation**

## 5.6 Storage Backplane Options

The 1U system has support for several backplane options.

For 2.5" drives, available backplane options include:

- 8 x 2.5" drive SAS/SATA backplane
- 8 x 2.5" drive combo SAS / PCIe\* SFF (NVMe) SSD backplane (Intel Accessory Kit **A1U44X25NVMEDK**)

For 3.5" drives, available options include:

- 4 x 3.5 SAS/SATA backplane

All available backplane options mount directly to the back of the drive bay as shown in the following illustration.

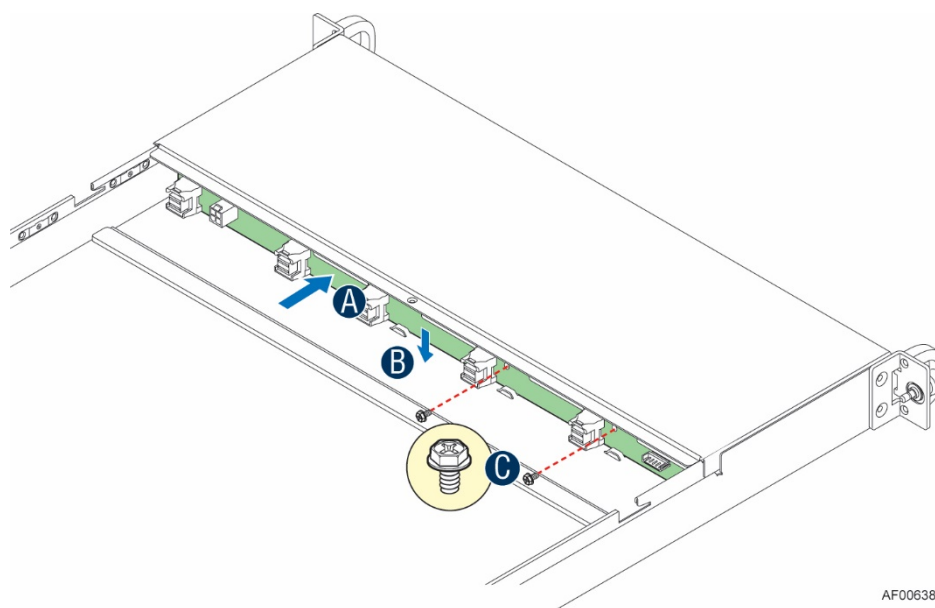

**Figure 36. Backplane Installation**

All available SAS/SATA compatible backplanes include the following common features:

- 12 Gb SAS and 6Gb SAS/SATA or slower support
- 29-pin SFF-8680 12 Gb rated drive interface connectors, providing both power and I/O signals to attached devices
- Hot swap support for SAS/SATA devices
- Mini-SAS HD input connectors that are 12Gb capable
- SGPIO SFF-8485 interface embedded within the sideband of the mini-SAS HD connectors
- I2C interface from a 5-pin connector for device status communication to the BMC over slave SMBus
- HSBP microcontroller – Cypress\* CY8C22545-24AXI Programmable System-on-Chip (PSoC\*) device
- LEDs to indicate drive activity and status for each attached device
- Device presence detect inputs to the microcontroller
- 5V VR for devices
- 3.3V VR for microcontroller
- In-application microcontroller FW updateable over the I2C interface
- FRU EEPROM support



- Temperature sensor through the use of a TMP75 (or equivalent) thermistor implementation with the microcontroller

### 5.6.1 SGPIO Functionality

Backplanes include support for an SFF-8485 compliant SGPIO interface used to activate the Status LED. This interface is also monitored by the microcontroller for generating FAULT, IDENTIFY, and REBUILD registers that in turn are monitored by the server board BMC for generating corresponding SEL events.

### 5.6.2 I2C Functionality

The microcontroller has a master/slave I2C connection to the server board BMC. The microcontroller is not an IPMB compliant device. The BMC will generate SEL events by monitoring registers on the HSBP microcontroller for DRIVE PRESENCE, FAULT, and RAID REBUILD in progress.

### 5.6.3 4 x 3.5" Drive Hot-Swap Backplane Overview

Intel Spare Product Code: **FR1304S3HSBP**

All 3.5" drive system SKUs within the product family will ship with a 4 x drive backplane capable of supporting 12 Gb/sec SAS and 6 Gb/sec SAS / SATA drives. Both hard disks and Solid State Devices (SSDs) can be supported within a common backplane. Each backplane can support either SATA or SAS devices. However, mixing of SATA and SAS devices within a common hot swap backplane is not supported. Supported devices are dependent on the type of host bus controller driving the backplane, SATA only or SAS.

The front side of the backplane includes 8 x 29-pin drive interface connectors, each capable of supporting 12 Gb SAS or 6 Gb SAS/SATA. The connectors are numbered 0 thru 3. Signals for all four drive connectors are routed to a single multi-port mini-SAS HD connector on the back side of the backplane.

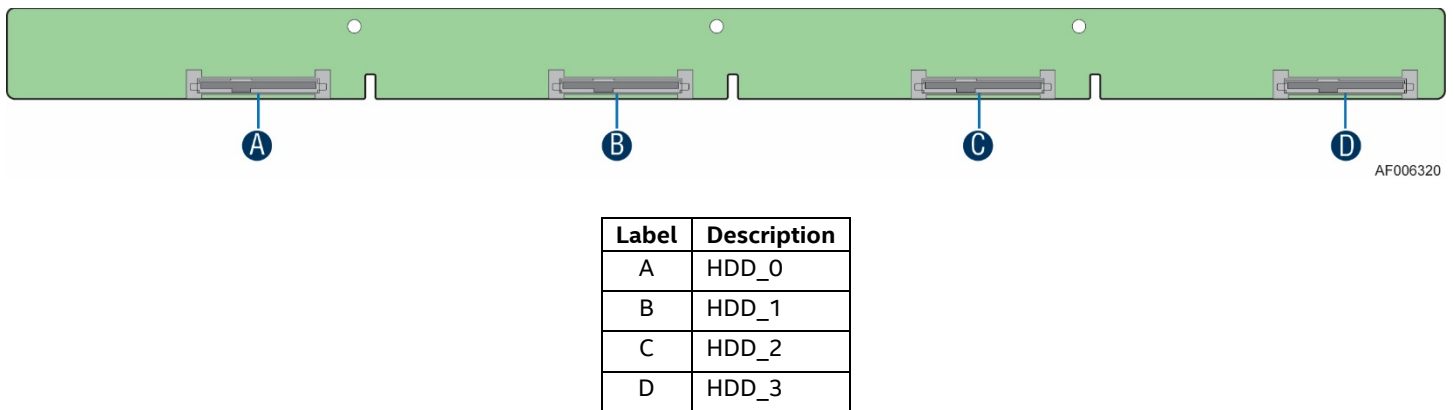

**Figure 37. 4 x 3.5" Drive Hot-Swap Backplane – front view**

On the backside of the backplane are several connectors. The following illustration identifies each.

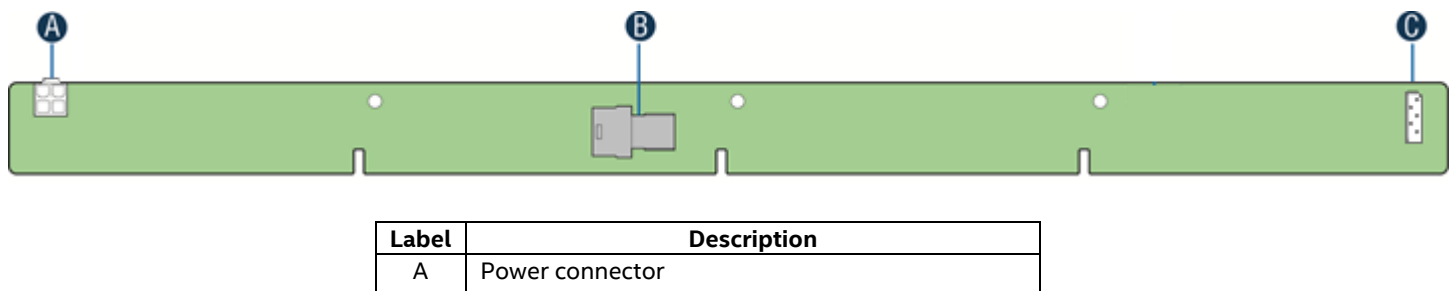

## Intel® Server System R1000WT Family TPS

B	SAS/SATA Ports 0-3 Mini-SAS HD cable connector
C	I2C connector

**Figure 38. 4 x 3.5" Drive Hot-Swap Backplane – rear view**

**A** – Power Harness Connector – The backplane includes a 2x2 connector supplying power to the backplane. Power is routed to the backplane via a power cable harness from the server board.

**B** – Multi-port Mini-SAS Cable Connector – The backplane includes one multi-port mini-SAS cable connector providing I/O signals for four SAS/SATA drives on the backplane. A cable can be routed from matching connectors on the server board or add-in SAS/SATA RAID cards.

**C** – I2C Cable Connector – The backplane includes a 1x5 cable connector used as a management interface to the server board.

### 5.6.4 8 x 2.5" Drive SAS Backplane

Intel Spare Product Code: **F1U8X25S3HSBP**

Most 2.5" drive system SKUs within the product family will ship with a 8 x drive backplane capable of supporting 12 Gb/sec SAS and 6 Gb/sec SAS / SATA drives. Both hard disks and Solid State Devices (SSDs) can be supported within a common backplane. Each backplane can support either SATA or SAS devices. However, mixing of SATA and SAS devices within a common hot swap backplane is not supported. Supported devices are dependent on the type of host bus controller driving the backplane, SATA only or SAS.

The front side of the backplane includes 8 x 29-pin drive interface connectors, each capable of supporting 12 Gb/s SAS or 6 Gb SAS/SATA. The connectors are numbered 0 thru 7. Signals for each set of four drive connectors (0-3 and 4-7), are routed to separate multi-port mini-SAS HD connectors on the back side of the backplane.

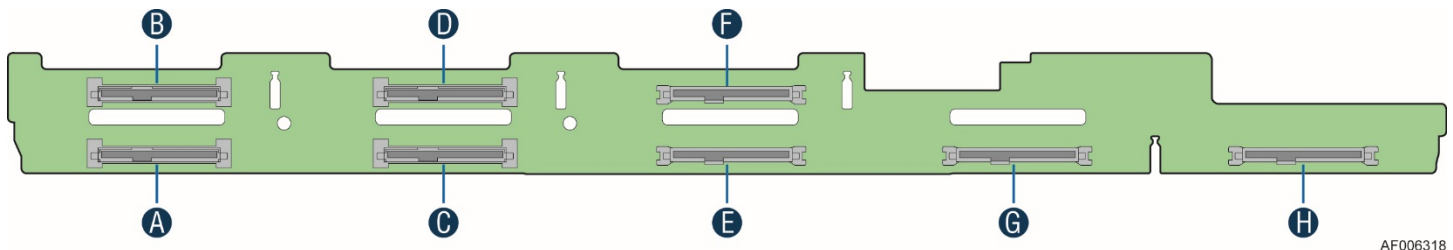

AF006318

Label	Description
A	HDD_0
B	HDD_1
C	HDD_2
D	HDD_3
E	HDD_4
F	HDD_5
G	HDD_6
H	HDD_7

**Figure 39. 8 x 2.5" Drive SAS/SATA Backplane – front view**

On the backside of each backplane there are several connectors. The following illustration identifies each.

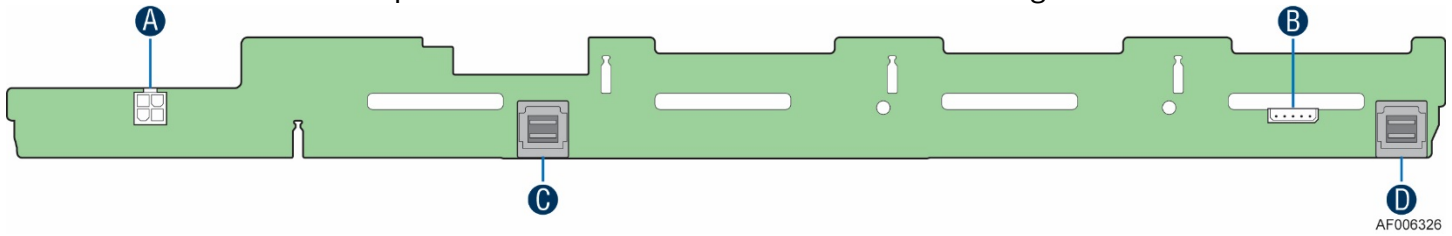

Label	Description
A	Power connector
B	I2C-In cable connector – From Server board
C	SAS/SATA Ports 4-7 Mini-SAS HD cable connector
D	SAS/SATA Ports 0-3 Mini-SAS HD cable connector

Figure 40. 8 x 2.5" Drive SAS/SATA Backplane – rear view

**A – Power Harness Connector** – The backplane includes a 2x2 connector supplying power to the backplane. Power is routed to the backplane via a power cable harness from the server board.

PIN	SIGNAL	SIGNAL	PIN
1	GND	P12V	3
2	GND	P12V	4

**B – I2C Cable Connectors** – The backplane includes a 1x5 cable connector used as a management interface to the server board.

PIN	SIGNAL
1	SMB_3V3SB_DAT
2	GND
3	SMB_3V3SB_CLK
4	SMB_ADD0
5	SMB_ADD1

**C and D – Multi-port Mini-SAS Cable Connectors** – The backplane includes two multi-port mini-SAS cable connectors, each providing I/O signals for four SAS/SATA hard drives on the backplane. Cables can be routed from matching connectors on the server board or add-in SAS/SATA RAID cards.

### 5.6.5 8 x 2.5" Drive Combo SAS / PCIe\* SFF (NVMe) SSD Backplane Accessory Kit

Intel Accessory Kit Product Code: **A1U44X25NVMEDK**

An optional eight drive Combo Backplane accessory kit is capable of supporting a combination of both SAS/SATA drives and up to four PCIe\* SFF (Small Form Factor) (NVMe) SSD drives.

---

Note – Different PCIe\* storage device manufacturers may reference their PCIe\* storage devices differently from one another. Some may reference them as PCIe SFF while others may reference them as NVMe. Visit <https://serverconfigurator.intel.com> for a list of supported PCIe\* storage devices.

---

The kit includes:

- 1 – 8 x 2.5" Drive Combo Backplane
- 1 – PCIe\* 4x4 Re-driver add-in card
- 4 – PCIe\* SFF (NVMe) SSD drive trays with Blue latches
- 4 – SAS/SATA drive trays with Green latches
- 2 – Dual port PCIe\* add-in card to backplane cables

#### Accessory Kit Integration and Usage Requirements:

- This kit is only supported in dual processor configurations
- The backplane is capable of supporting 12 Gb/s SAS or 6 Gb SAS/SATA drives. The SAS/SATA drives are hot-swappable. However, mixing of SATA and SAS drives within a common hot swap backplane is not recommended.
- PCIe\* SFF (NVMe) SSDs are hot swap / hot plug capable. Support and usage is OS dependent (See Table 37). The server system must have the following System Software installed.
  - System BIOS version **R01.01.1008** or later
  - BMC Firmware version **01.18.7601** or later
  - FRUSDR version **1.06** or later

System software updates can be downloaded from the following Intel web site:

<http://downloadcenter.intel.com/>

- To identify a PCIe\* SFF drive from a SAS / SATA drive, two different drive carriers are included in the kit. Drive carriers with a Blue latch are used to identify PCIe\* SFF (NVMe) drives. Drives carriers with a Green latch are used to identify SAS / SATA drives

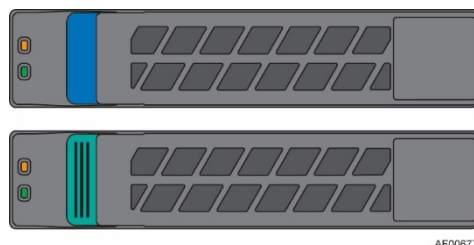

AF006776

**Figure 41. Combo Backplane Kit Device Carrier Identification**

## Intel® Server System R1000WT Family TPS

- Each drive carrier includes separate LED indicators for drive Activity and drive Status. However, their functionality may differ depending on the drive type. For SAS and SATA LED support, see section 6.3. PCIe\* SFF (NVMe) LED support is as follows:

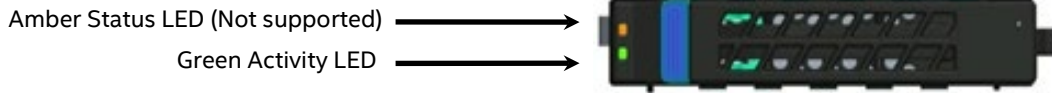

- Any combination and number of drives up to eight can be supported as long as the number of PCIe\* SFF (NVMe) devices does not exceed four and they are installed into any of the first four drive connectors on the backplane. The remaining drives can be SAS or SATA.

NOTE: Mixing of PCIe\* SFF and SAS/SATA devices in an alternating manner (as identified in the following example) is not a recommended configuration.

Example – “SAS/SATA” + “PCIe\* SFF” + “SAS/SATA” + “PCIe\* SFF”.

- The front side of the backplane includes eight drive interface connectors: four SFF-8639 PCIe/SAS/SATA capable, and four SFF-8680 SAS/SATA only. All eight connectors can support SATA or SAS drives, but only the last four on the backplane are capable of supporting PCIe\* SFF (NVMe) drives.

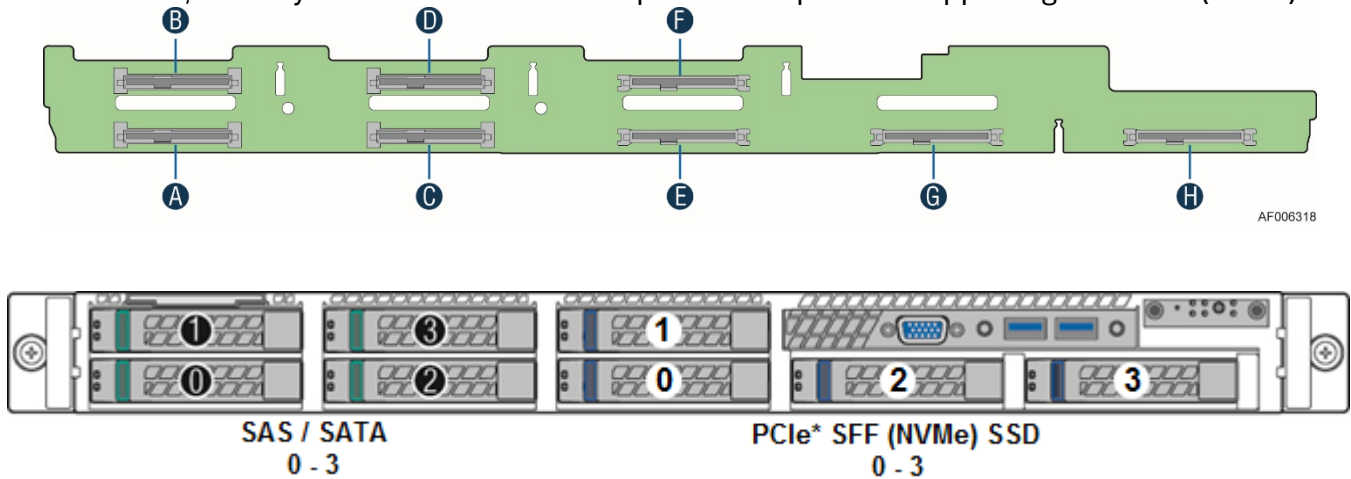

Labels	Description
A	SAS/SATA_0
B	SAS/SATA_1
C	SAS/SATA_2
D	SAS/SATA_3
E	PCIe* SFF_0 or SAS/SATA_4
F	PCIe* SFF_1 or SAS/SATA_5
G	PCIe* SFF_2 or SAS/SATA_6
H	PCIe* SFF_3 or SAS/SATA_7

Figure 42. 8 x 2.5" Combo SAS / PCIe\* SFF (NVMe) Backplane – Front View

On the backside of the backplane are several connectors. The following illustration identifies each.

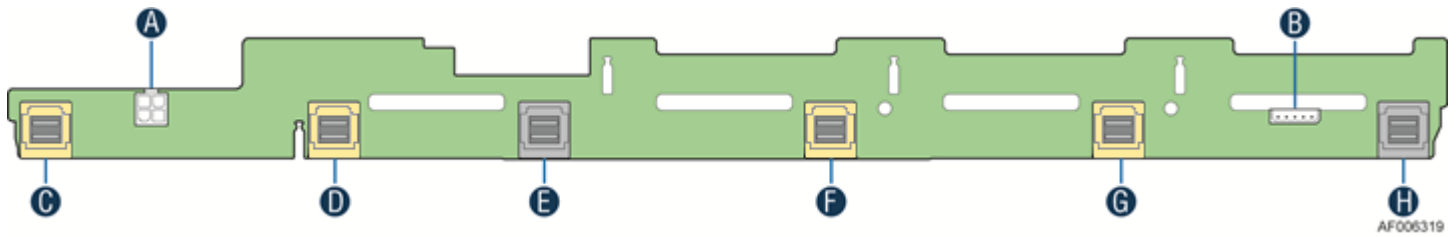

Label	Silkscreen	Description
A	"PWR"	Power connector
B	"I2C"	I <sup>2</sup> C-In cable connector – From server board
C	"PCI*_3"	PCIe* SFF Device #3 Mini-SAS HD cable connector
D	"PCI*_2"	PCIe* SFF Device #2 Mini-SAS HD cable connector
E	"PORT 4-7"	SAS/SATA Ports 4-7 Mini-SAS HD cable connector
F	"PCI*_0"	PCIe* SFF Device #0 Mini-SAS HD cable connector
G	"PCI*_1"	PCIe* SFF Device #1 Mini-SAS HD cable connector
H	"PORT 0-3"	SAS/SATA Ports 0-3 Mini-SAS HD cable connector

**Figure 43. Combo Backplane Rear Connector Identification**

**Connector A** – Power Harness Connector – The backplane includes a 2x2 connector supplying power to the backplane. Power is routed to each installed backplane via a multi-connector power cable harness from the server board.

PIN	SIGNAL	SIGNAL	PIN
1	GND	P12V	3
2	GND	P12V	4

**Connectors B** – I2C Cable Connector – The backplane includes one 1x5 cable connector used as a management interface between the server board and the installed backplane.

PIN	SIGNAL
1	SMB_3V3SB_DAT
2	GND
3	SMB_3V3SB_CLK
4	SMB_ADD0
5	SMB_ADD1

**Connectors C and H** – Multi-port Mini-SAS HD Cable Connectors – The backplane includes two multi-port mini-SAS HD cable connectors, each providing SGPIO and I/O signals for four SAS/SATA hard drives on the backplane. Cables can be routed from matching connectors on the server board, installed add-in SAS/SATA RAID cards, or optionally installed SAS expander cards for drive configurations of greater than 8 hard drives.

**Connectors D, E, F and G** – Each connector supports a single PCIe\* SFF SFF device. Each connector is cabled directly to an add-in PCIe\* SFF SFF controller card installed in one of the riser card slots on the server board.

- The PCIe\* SFF add-in re-driver card is ONLY supported when configured in Riser Slot #2 of the server board. The PCIe\* SFF add-in re-driver card will not be identified or configured by the system BIOS when installed in Riser Slot #1.

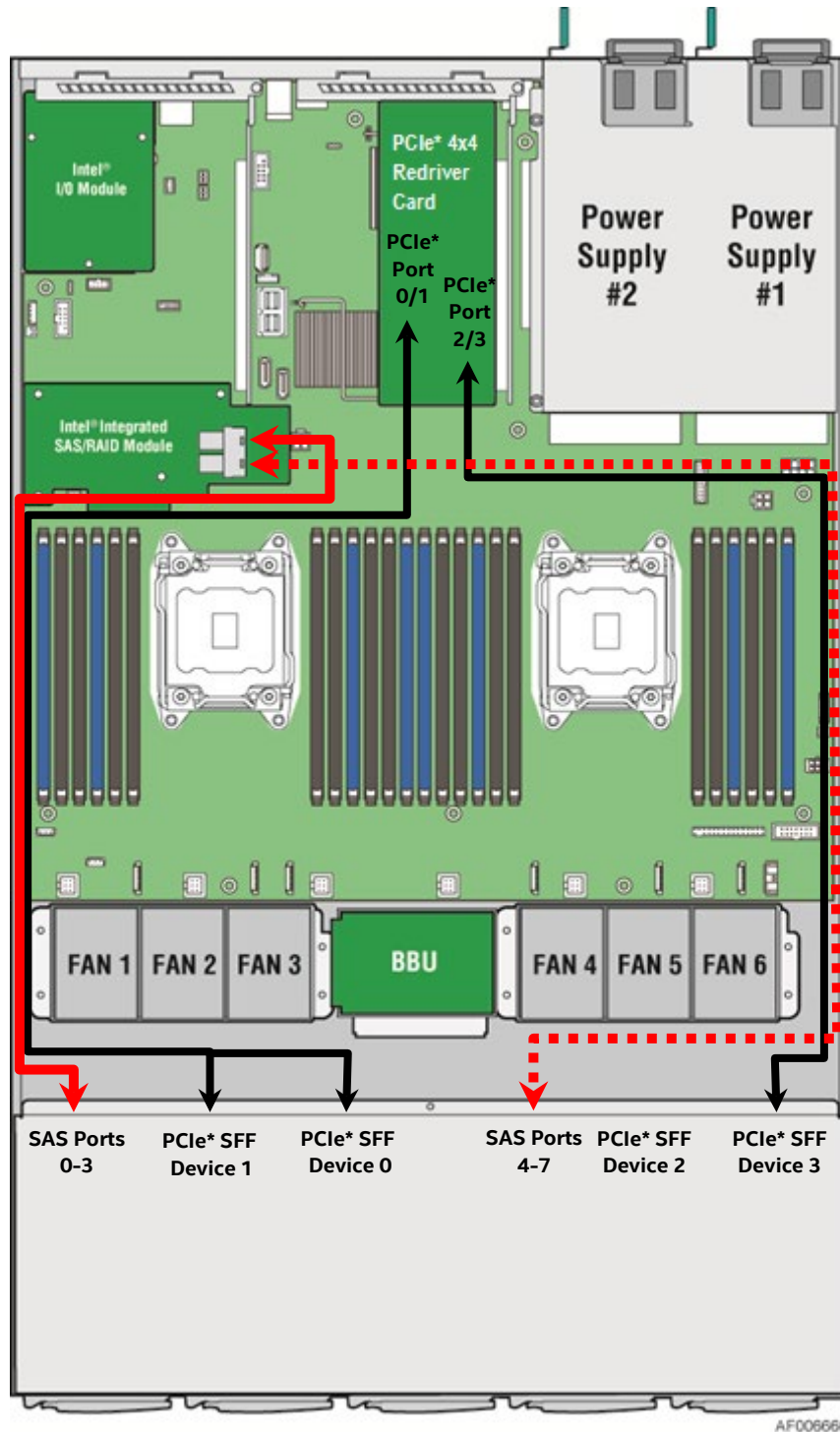
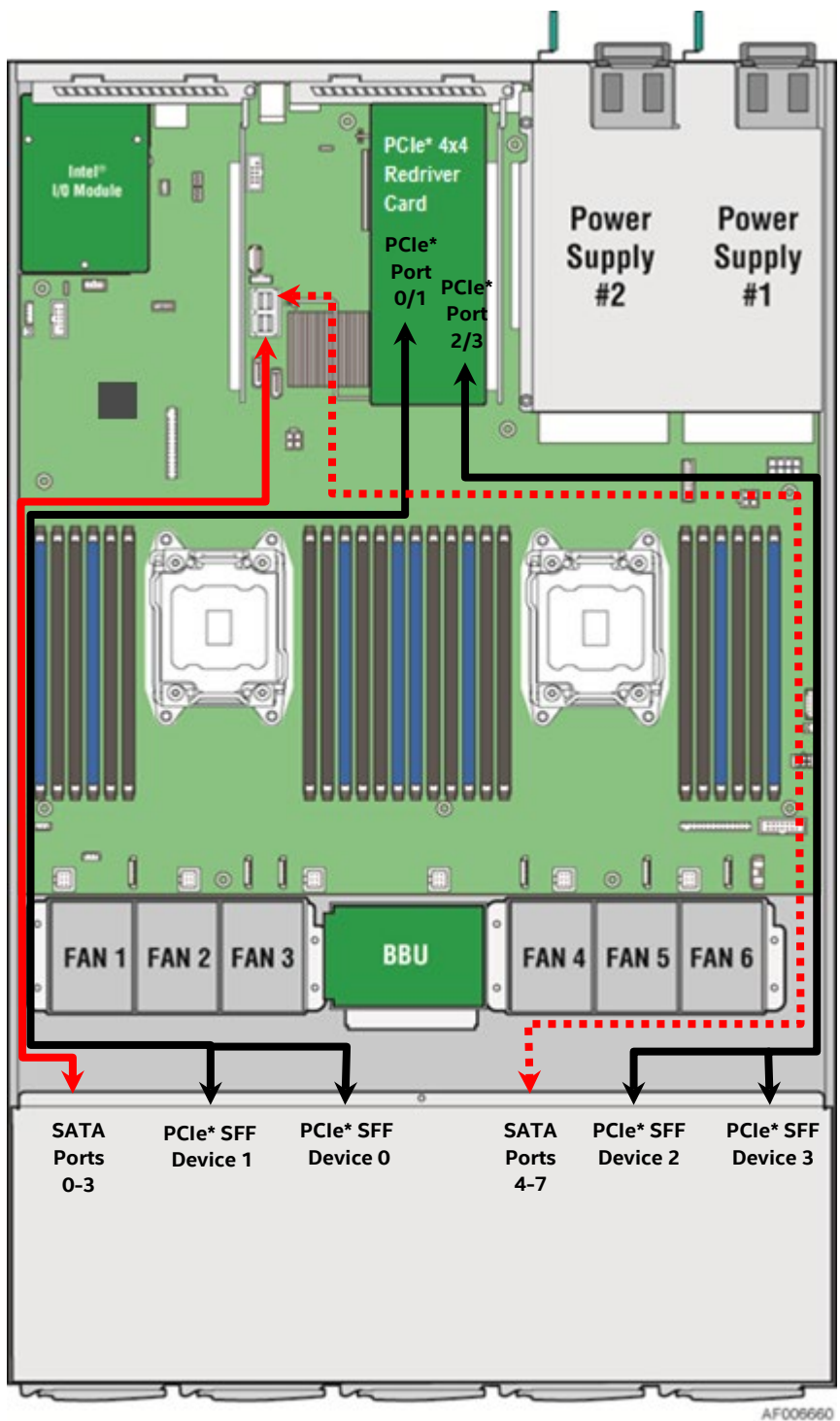

Figure 44. Combo Backplane Cable Routing – PCIe\* SFF (NVMe) + SAS



AF006660

Figure 45. Combo Backplane Cable Routing – PCIe\* SFF (NVMe) + SATA



**5.6.5.1 Intel® Accessory Kit A2U44X25NVMEDK Operating System Support List**

As of this writing, Intel® accessory kit **A2U44X25NVMEDK** provides support for the following operating systems. This list will be updated as new operating systems are validated with this kit by Intel.

**Table 29. Intel® Accessory Kit A2U44X25NVMEDK Operating System Support List**

Operating System	A2U44X25NVMEDK support (Y/N)	PCIe* SFF (NVMe) OS Boot support (Y/N)	PCIe* SFF (NVMe) Hot Plug / Hot Swap Support (Y/N)
Windows Server 2012* R2 w/Updated Datacenter x64, Legacy boot	Yes	No	Yes
Windows Server 2012 R2 w/Updated Datacenter x64, uEFI boot	Yes	Yes	Yes
Windows Hyper-V 2012* R2 x64, Legacy boot	Yes	No	Yes
Windows Hyper-V 2012 R2 x64, uEFI boot	Yes	Yes	Yes
Red Hat Enterprise Linux 7.0* x64, Legacy boot	Yes	No	No
Red Hat Enterprise Linux 7.0 x64, uEFI boot	Yes	Yes	No
Red Hat Enterprise Linux 6.5* x64, Legacy boot	No	N/A	N/A
Red Hat Enterprise Linux 6.5 x64, uEFI boot	No	N/A	N/A
Red Hat Enterprise Linux 6.5 x86, Legacy boot	No	N/A	N/A
SuSE Linux Enterprise Server 11* SP3 x64, Legacy Boot	No	N/A	N/A
SuSE Linux Enterprise Server 11 SP3 x64, uEFI Boot	No	N/A	N/A
SuSE Linux Enterprise Server 11 SP3 x86, Legacy Boot	No	N/A	N/A
Windows Server 2008* R2 sp1 x64, Legacy Boot	Yes	No	Yes
Windows Server 2008 R2 sp1 x64, uEFI Boot	Yes	No	Yes
Windows Server 2008 R2 sp1 x86, Legacy Boot	No	N/A	N/A
Windows 7* x64, Legacy boot	No	N/A	N/A
Windows 7 x64, uEFI boot	No	N/A	N/A
VMWare ESXi 5.5* U2	No	N/A	N/A
Ubuntu 14.04 Server* x64, Legacy Boot	No	N/A	N/A
Ubuntu 14.04 Server x64, EFI Boot	No	N/A	N/A
Ubuntu 14.04 Server x86, Legacy Boot	No	N/A	N/A
CentOS 6.5* x64, Legacy Boot	No	N/A	N/A
CentOS 6.5 x64, uEFI Boot	No	N/A	N/A
CentOS 6.5 x86, Legacy Boot	No	N/A	N/A
FreeBSD 10* x64 Legacy Boot	No	N/A	N/A
FreeBSD 10 x86 Legacy Boot	No	N/A	N/A

## 5.7 Low Profile eUSB SSD Support

The system provides support for a low profile eUSB SSD storage device. A 2mm 2x5-pin connector labeled “eUSB SSD” near the rear I/O section of the server board is used to plug this small flash storage device into.

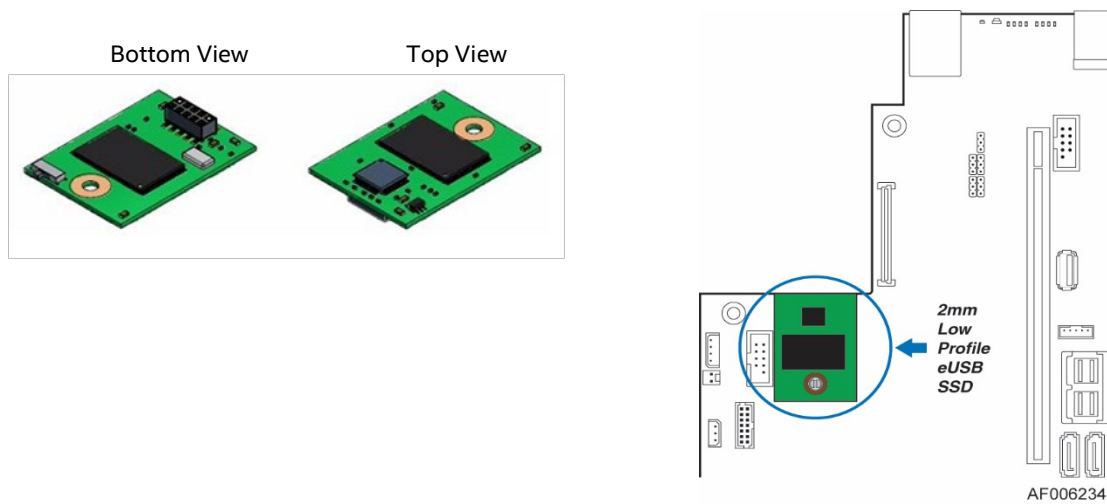

**Figure 46. Low Profile eUSB SSD Support**

eUSB features include:

- 2 wire small form factor Universal Serial Bus 2.0 (Hi-Speed USB) interface to host
- Read Speed up to 35 MB/s and write Speed up to 24 MB/s
- Capacity range from 256 MB to 16 GB
- Support USB Mass Storage Class requirements for Boot capability

Visit <https://serverconfigurator.intel.com> for a list of supported devices.

## 5.8 SATA DOM Support

The system has support for up to two vertical low profile Disk-on-Module (DOM) devices. Supported SATADOMs for this server board include those from Apacer\* or Innodisk\*.

---

**Note:** In this server system, SATADOMs from Innodisk\* must have firmware version S130710 or later.

---

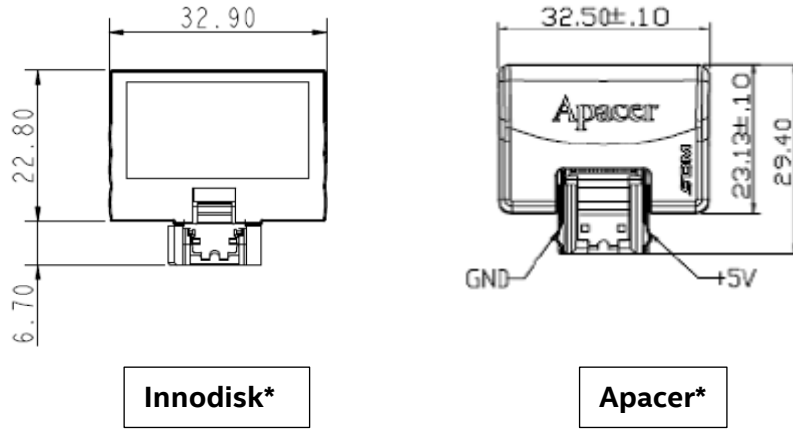

Each installed SATA DOM plugs directly into one of the white single port SATA connectors on the server board, which provide both power and I/O signals.

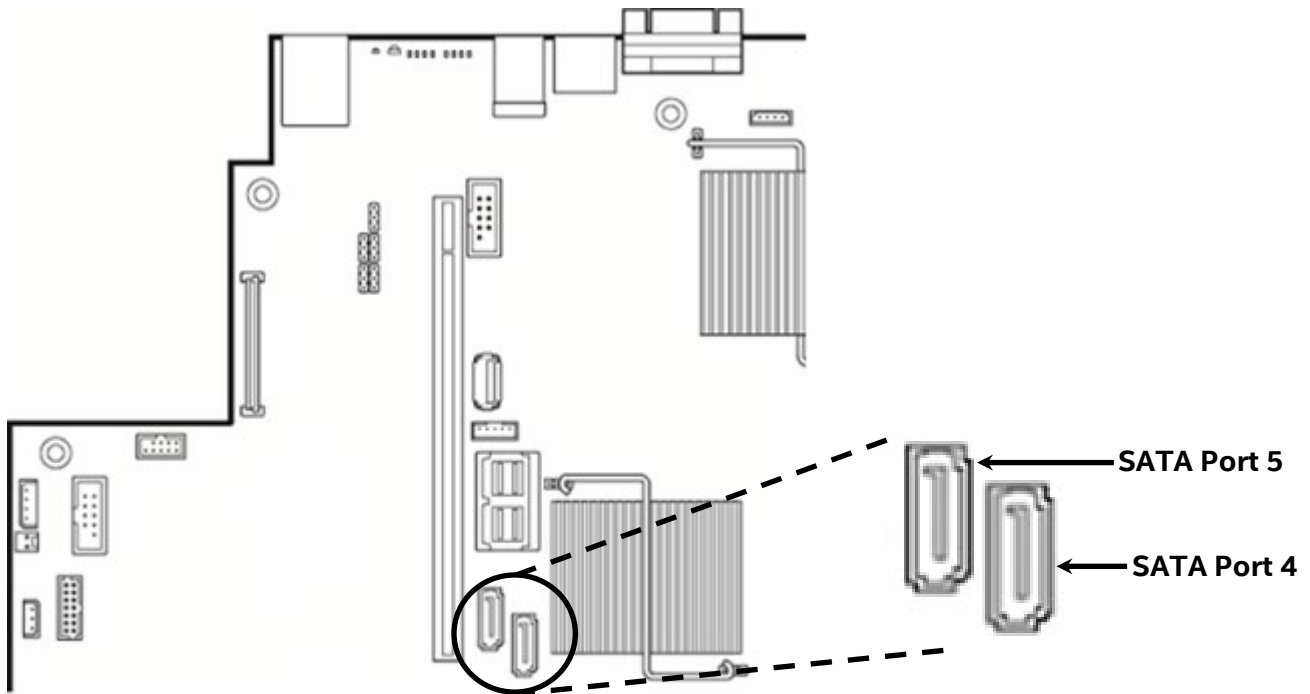

Each single port SATA connector has the following 7 + 2 pin-out.

PIN	SIGNAL
PWR 2	GND
1	GND
2	SATAx_TX_DP
3	SATAx_TX_DN
4	GND
5	SATAx_RX_DN
6	SATAx_RX_DP
7	GND
PWR 1	5V

---

**Note:** With a SATADOM device installed, only low profile PCIe\* add-in cards can be used in Riser Slot #2

---

Visit <https://serverconfigurator.intel.com> for a list of supported SATA DOM devices.

## 6. Storage Controller Options Overview

The server platform supports many different embedded and add-in SAS/SATA controller options to provide a large number of possible storage configurations. This section will provide an overview of the different options available.

### 6.1 Embedded SATA/SATA RAID Support

The server board utilizes two chipset embedded AHCI SATA controllers, identified as **SATA** and **sSATA**, providing for up to ten 6 Gb/sec Serial ATA (SATA) ports.

The AHCI **SATA** controller provides support for up to six SATA ports on the server board:

- Four SATA ports from the Mini-SAS HD (SFF-8643) connector labeled “**SATA Ports 0-3**” on the server board
- Two SATA ports accessed via two white single port connectors labeled “**SATA-4**” and “**SATA-5**” on the server board

The AHCI **sSATA** controller provides support for up to four SATA ports on the server board:

- Four SATA ports from the Mini-SAS HD (SFF-8643) connector labeled “**sSATA Ports 0-3**” on the server board

The following diagram identifies the location of all on-board SATA features.

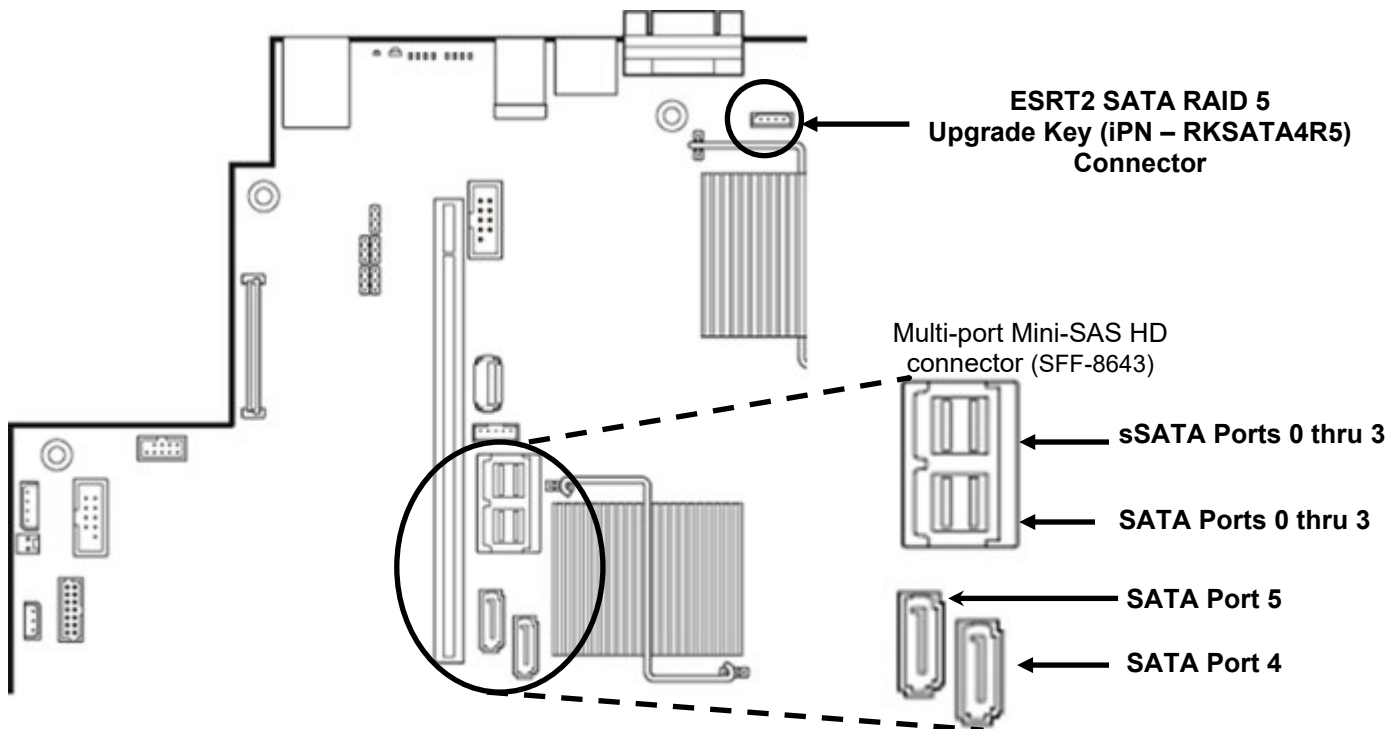

Figure 47. On-board SATA Features

Note: the onboard SATA controllers are not compatible with and cannot be used with RAID Expander Cards.

**Table 30. SATA and sSATA Controller Feature Support**

Feature	Description	AHCI / RAID Disabled	AHCI / RAID Enabled
Native Command Queuing (NCQ)	Allows the device to reorder commands for more efficient data transfers	N/A	Supported
Auto Activate for DMA	Collapses a DMA Setup then DMA Activate sequence into a DMA Setup only	N/A	Supported
Hot Plug Support	Allows for device detection without power being applied and ability to connect and disconnect devices without prior notification to the system	N/A	Supported
Asynchronous Signal Recovery	Provides a recovery from a loss of signal or establishing communication after hot plug	N/A	Supported
6 Gb/s Transfer Rate	Capable of data transfers up to 6 Gb/s	Supported	Supported
ATAPI Asynchronous Notification	A mechanism for a device to send a notification to the host that the device requires attention	N/A	Supported
Host & Link Initiated Power Management	Capability for the host controller or device to request Partial and Slumber interface power states	N/A	Supported
Staggered Spin-Up	Enables the host the ability to spin up hard drives sequentially to prevent power load problems on boot	Supported	Supported
Command Completion Coalescing	Reduces interrupt and completion overhead by allowing a specified number of commands to complete and then generating an interrupt to process the commands		N/A

The SATA controller and the sSATA controller can be independently enabled and disabled and configured through the <F2> BIOS Setup Utility under the “Mass Storage Controller Configuration” menu screen. The following table identifies supported setup options.

**Table 31. SATA and sSATA Controller BIOS Utility Setup Options**

SATA Controller	sSATA Controller	Supported
AHCI	AHCI	Yes
AHCI	Enhanced	Yes
AHCI	Disabled	Yes
AHCI	RSTe	Yes
AHCI	ESRT2	Microsoft* Windows Only
Enhanced	AHCI	Yes
Enhanced	Enhanced	Yes
Enhanced	Disabled	Yes
Enhanced	RSTe	Yes
Enhanced	ESRT2	Yes
Disabled	AHCI	Yes
Disabled	Enhanced	Yes
Disabled	Disabled	Yes
Disabled	RSTe	Yes
Disabled	ESRT2	Yes
RSTe	AHCI	Yes

## Intel® Server System R1000WT Family TPS

SATA Controller	sSATA Controller	Supported
RSTe	Enhanced	Yes
RSTe	Disabled	Yes
RSTe	RSTe	Yes
RSTe	ESRT2	No
ESRT2	AHCI	Microsoft* Windows Only
ESRT2	Enhanced	Yes
ESRT2	Disabled	Yes
ESRT2	RSTe	No
ESRT2	ESRT2	Yes

### 6.1.1 Staggered Disk Spin-Up

Because of the high density of disk drives that can be attached to the Intel® C610 Onboard AHCI SATA Controller and the sSATA Controller, the combined startup power demand surge for all drives at once can be much higher than the normal running power requirements and could require a much larger power supply for startup than for normal operations.

In order to mitigate this and lessen the peak power demand during system startup, both the AHCI SATA Controller and the sSATA Controller implement a Staggered Spin-Up capability for the attached drives. This means that the drives are started up separately, with a certain delay between disk drives starting.

For the Onboard SATA Controller, Staggered Spin-Up is an option – AHCI HDD Staggered Spin-Up – in the Setup Mass Storage Controller Configuration screen found in the <F2> BIOS Setup Utility.

## 6.2 Embedded SATA SW-RAID support

The server board has embedded support for two SATA SW-RAID options:

- Intel® Rapid Storage Technology (RSTe) 4.1
- Intel® Embedded Server RAID Technology 2 (ESRT2) 1.41 based on LSI\* MegaRAID SW RAID technology

Using the <F2> BIOS Setup Utility, accessed during system POST, options are available to enable/disable SW RAID, and select which embedded software RAID option to use.

---

**Note:** RAID partitions created using either RSTe or ESRT2 cannot span across the two embedded SATA controllers. Only drives attached to a common SATA controller can be included in a RAID partition.

---

See Table 2 for a list of supported Operating Systems.

### 6.2.1 Intel® Rapid Storage Technology (RSTe) 4.1

Intel® Rapid Storage Technology offers several options for RAID (Redundant Array of Independent Disks) to meet the needs of the end user. AHCI support provides higher performance and alleviates disk bottlenecks by taking advantage of the independent DMA engines that each SATA port offers in the chipset.

- **RAID Level 0** – Non-redundant striping of drive volumes with performance scaling of up to 6 drives, enabling higher throughput for data intensive applications such as video editing.
- Data security is offered through **RAID Level 1**, which performs mirroring.

- **RAID Level 10** provides high levels of storage performance with data protection, combining the fault-tolerance of RAID Level 1 with the performance of RAID Level 0. By striping RAID Level 1 segments, high I/O rates can be achieved on systems that require both performance and fault-tolerance. RAID Level 10 requires 4 hard drives, and provides the capacity of two drives.
- **RAID Level 5** provides highly efficient storage while maintaining fault-tolerance on 3 or more drives. By striping parity, and rotating it across all disks, fault tolerance of any single drive is achieved while only consuming 1 drive worth of capacity. That is, a 3 drive RAID 5 has the capacity of 2 drives, or a 4 drive RAID 5 has the capacity of 3 drives. RAID 5 has high read transaction rates, with a medium write rate. RAID 5 is well suited for applications that require high amounts of storage while maintaining fault tolerance.

---

**Note:** RAID configurations cannot span across the two embedded AHCI SATA controllers.

---

By using Intel® RSTe, there is no loss of PCI resources (request/grant pair) or add-in card slot. Intel® RSTe functionality requires the following:

- The SW-RAID option must be enable in <F2> BIOS Setup
- Intel® RSTe option must be selected in <F2> BIOS Setup
- Intel® RSTe drivers must be loaded for the installed operating system
- At least two SATA drives needed to support RAID levels 0 or 1
- At least three SATA drives needed to support RAID level 5
- At least four SATA drives needed to support RAID level 10

With Intel® RSTe SW-RAID enabled, the following features are made available:

- A boot-time, pre-operating system environment, text mode user interface that allows the user to manage the RAID configuration on the system. Its feature set is kept simple to keep size to a minimum, but allows the user to create and delete RAID volumes and select recovery options when problems occur. The user interface can be accessed by pressing the <CTRL-I> keys during system POST.
- Provides boot support when using a RAID volume as a boot disk. It does this by providing Int13 services when a RAID volume needs to be accessed by MS-DOS applications (such as NTLDR) and by exporting the RAID volumes to the System BIOS for selection in the boot order
- At each boot up, provides the user with a status of the RAID volumes

## 6.2.2 Intel® Embedded Server RAID Technology 2 (ESRT2) 1.41

Features of ESRT2 include the following:

- Based on LSI\* MegaRAID Software Stack
- Software RAID with system providing memory and CPU utilization
- **RAID Level 0** - Non-redundant striping of drive volumes with performance scaling up to 6 drives, enabling higher throughput for data intensive applications such as video editing.
- Data security is offered through **RAID Level 1**, which performs mirroring.
- **RAID Level 10** provides high levels of storage performance with data protection, combining the fault-tolerance of RAID Level 1 with the performance of RAID Level 0. By striping RAID Level 1 segments, high I/O rates can be achieved on systems that require both performance and fault-tolerance. RAID Level 10 requires 4 hard drives, and provides the capacity of two drives
- Optional support for **RAID Level 5**



## Intel® Server System R1000WT Family TPS

- Enabled with the addition of an optionally installed ESRT2 SATA RAID 5 Upgrade Key (**iPN - RKSATA4R5**)
- **RAID Level 5** provides highly efficient storage while maintaining fault-tolerance on 3 or more drives. By striping parity, and rotating it across all disks, fault tolerance of any single drive is achieved while only consuming 1 drive worth of capacity. That is, a 3 drive RAID 5 has the capacity of 2 drives, or a 4 drive RAID 5 has the capacity of 3 drives. RAID 5 has high read transaction rates, with a medium write rate. RAID 5 is well suited for applications that require high amounts of storage while maintaining fault tolerance

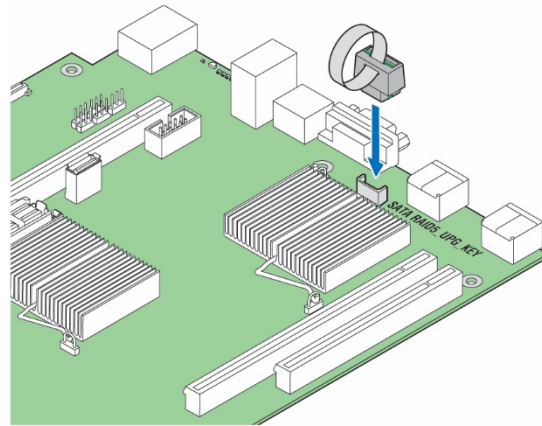

AF006246

**Figure 48. SATA RAID 5 Upgrade Key**

- Maximum drive support = 6 SATA controller + 4 sSATA controller (Maximum on-board SATA port support)
- Open Source Compliance = Binary Driver (includes Partial Source files) or Open Source using MDRAID layer in Linux\*.

---

**Note:** RAID configurations cannot span across the two embedded AHCI SATA controllers.

---

## 6.3 Intel® Integrated RAID Module Support

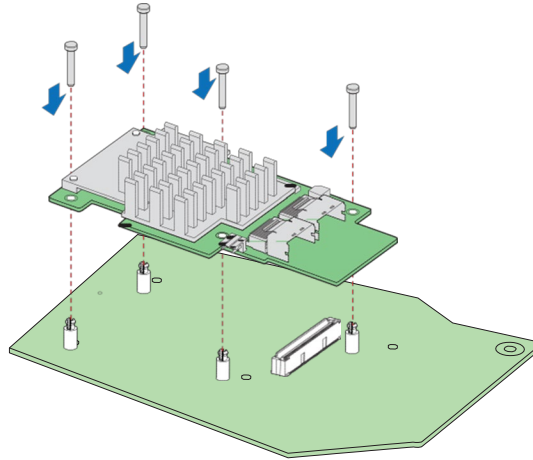

**Figure 49. Intel® Integrated RAID Module**

The system has support for many Intel and 3<sup>rd</sup> party PCIe add-in 6G and 12Gb RAID adapters which can be installed in available PCIe add-in cards slots. For system configurations with limited add-in card slot availability, an optional Intel® Integrated RAID mezzanine module can be installed onto a high density 80-pin connector (labeled “SAS Module”) on the server board.

Please visit the Intel® Server Configurator Tool at the following website for a list of supported Intel® Integrated RAID options:

<https://serverconfigurator.intel.com>

### 6.3.1 Intel® RAID Maintenance Free Backup Unit (RMFBU) Support

The 1U system has support for one or two Intel® RAID Maintenance Free Backup Units (RMFBU).

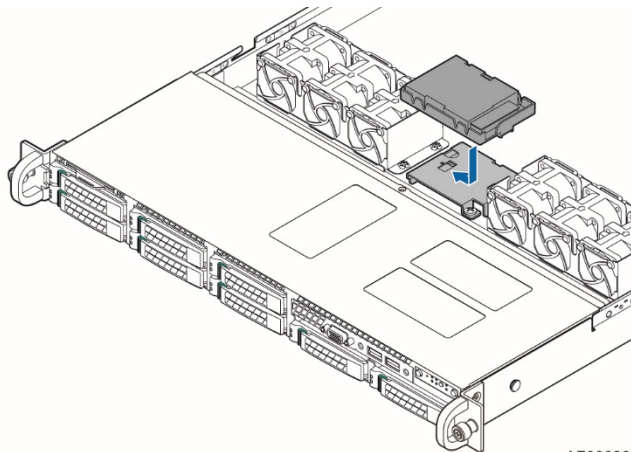

AF006262

**Figure 50. Support for single Intel® RAID Maintenance Free Backup Unit (Standard Option)**

Support for two RMFBUs will require the use of an optional bracket capable of supporting stacked RMFBUs. Intel Accessory Kit order code – **AWTAUXBBUBKT**

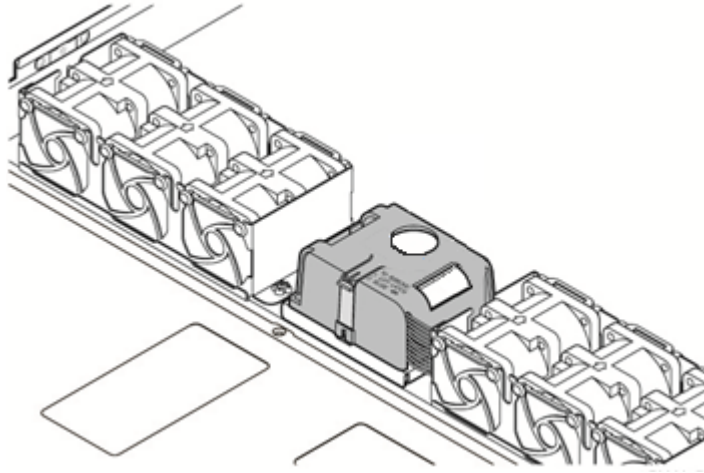

**Figure 51. Support for dual Intel® RAID Maintenance Free Backup Units (Optional Accessory)**

## 7. Front Control Panel and I/O Panel Overview

---

All system configurations include a Control Panel and I/O Panel on the front of the system. On systems that support 8x2.5" drives, the I/O Panel can be replaced with a SATA optical drive.

### 7.1 I/O Panel Features

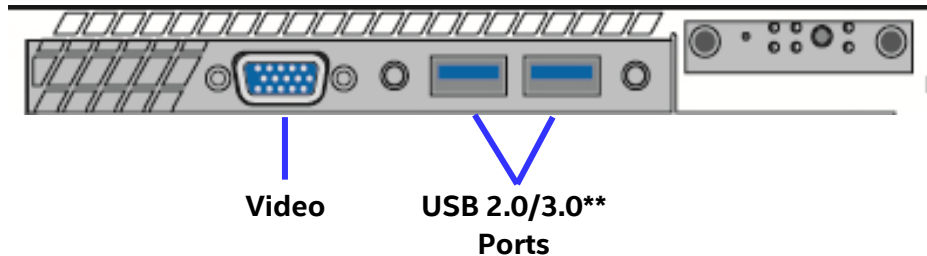

Figure 52. Front I/O Panel Features

**Video connector** – The front I/O Panel video connector gives the option of attaching a monitor to the front of the system. When BIOS detects that a monitor is attached to the front video connector, it disables the video signals routed to the on-board video connector on the back of the system. Video resolutions from the front video connector may be lower than that of the rear on-board video connector. A short video cable should be used for best resolution. The front video connector is cabled to a 2x7 header on the server board labeled “FP Video”.

**USB 2.0/3.0 Ports** –The front I/O panel includes two USB 2.0/3.0 ports. The USB ports are cabled to a Blue 2x5 connector on the server board labeled “FP\_USB”.

---

**\*\* Note:** Due to signal strength limits associated with USB 3.0 ports cabled to a front panel, some marginally compliant USB 3.0 devices may not be supported from these ports. In addition, server systems based on the Intel® Server Board S2600WT cannot be USB 3.0 certified with USB 3.0 ports cabled to a front panel.

---

## 7.2 Control Panel Features

The system includes a control panel that provides push button system controls and LED indicators for several system features. Depending on the hard drive configuration, the front control panel may come in either of two formats; however, both provide the same functionality. This section will provide a description for each front control panel feature.

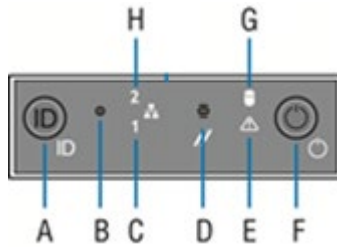

Label	Description	Label	Description
A	System ID Button w/Integrated LED	E	System Status LED
B	NMI Button (recessed, tool required for use)	F	Power/Sleep Button w/Integrated LED
C	NIC-1 Activity LED	G	Storage Drive Activity LED
D	System Cold Reset Button (recessed, tool required for use)	H	NIC-2 Activity LED

**Figure 53. Front Control Panel Options**

**A – System ID Button w/Integrated LED** – Toggles the integrated ID LED and the Blue server board ID LED on and off. The System ID LED is used to identify the system for maintenance when installed in a rack of similar server systems. The System ID LED can also be toggled on and off remotely using the IPMI “Chassis Identify” command which will cause the LED to blink for 15 seconds.

**B – NMI Button** – When the NMI button is pressed, it puts the server in a halt state and issues a non-maskable interrupt (NMI). This can be useful when performing diagnostics for a given issue where a memory download is necessary to help determine the cause of the problem. To prevent an inadvertent system halt, the actual NMI button is located behind the Front Control Panel faceplate where it is only accessible with the use of a small tipped tool like a pin or paper clip.

**C and H – Network Activity LEDs** – The Front Control Panel includes an activity LED indicator for each on-board Network Interface Controller (NIC). When a network link is detected, the LED will turn on solid. The LED will blink once network activity occurs at a rate that is consistent with the amount of network activity that is occurring.

**D – System Cold Reset Button** – When pressed, this button will reboot and re-initialize the system. To prevent an inadvertent system reset, the actual Reset button is located behind the Front Control Panel faceplate where it is only accessible with the use of a small tipped tool like a pin or paper clip.

**E – System Status LED** – The System Status LED is a bi-color (Green/Amber) indicator that shows the current health of the server system. The system provides two locations for this feature; one is located on the Front Control Panel, the other is located on the back edge of the server board, viewable from the back of the system. Both LEDs are tied together and will show the same state. The System Status LED states are driven by the on-board platform management subsystem. The following table provides a description of each supported LED state.

Table 32. System Status LED State Definitions

Color	State	Criticality	Description
Off	System is not operating	Not ready	<ul style="list-style-type: none"> <li>System is powered off (AC and/or DC).</li> <li>System is in EuP Lot6 Off Mode.</li> <li>System is in S5 Soft-Off State.</li> </ul>
Green	Solid on	Ok	<p>Indicates that the System is running (in S0 State) and its status is 'Healthy'. The system is not exhibiting any errors. AC power is present and BMC has booted and manageability functionality is up and running.</p> <p>After a BMC reset, and in conjunction with the Chassis ID solid ON, the BMC is booting Linux*. Control has been passed from BMC uBoot to BMC Linux* itself. It will be in this state for ~10~20 seconds</p>
Green	~1 Hz blink	Degraded - system is operating in a degraded state although still functional, or system is operating in a redundant state but with an impending failure warning	<p>System degraded:</p> <ul style="list-style-type: none"> <li>Redundancy loss such as power-supply or fan. Applies only if the associated platform sub-system has redundancy capabilities.</li> <li>Fan warning or failure when the number of fully operational fans is less than minimum number needed to cool the system.</li> <li>Non-critical threshold crossed – Temperature (including HSBP temp), voltage, input power to power supply, output current for main power rail from power supply and Processor Thermal Control (Therm Ctrl) sensors.</li> <li>Power supply predictive failure occurred while redundant power supply configuration was present.</li> <li>Unable to use all of the installed memory (more than 1 DIMM installed).</li> <li>Correctable Errors over a threshold and migrating to a spare DIMM (memory sparing). This indicates that the system no longer has spared DIMMs (a redundancy lost condition). Corresponding DIMM LED lit.</li> <li>In mirrored memory mode, when memory mirroring takes place and system loses memory redundancy.</li> <li>In mirrored memory mode, and threshold for correctable errors has been crossed</li> <li>Battery failure.</li> <li>BMC executing in uBoot. (Indicated by Chassis ID blinking at 3Hz). System in degraded state (no manageability). BMC uBoot is running but has not transferred control to BMC Linux*. Server will be in this state 6-8 seconds after BMC reset while it pulls the Linux* image into flash.</li> <li>BMC Watchdog has reset the BMC.</li> <li>Power Unit sensor offset for configuration error is asserted.</li> <li>HDD HSC is off-line or degraded.</li> </ul>

Intel® Server System R1000WT Family TPS

Color	State	Criticality	Description
Amber	~1 Hz blink	Non-critical - System is operating in a degraded state with an impending failure warning, although still functioning	<p>Non-fatal alarm – system is likely to fail:</p> <ul style="list-style-type: none"> <li>• Critical threshold crossed – Voltage, temperature (including HSBP temp), input power to power supply, output current for main power rail from power supply and PROCHOT (Therm Ctrl) sensors.</li> <li>• VRD Hot asserted.</li> <li>• Minimum number of fans to cool the system not present or failed</li> <li>• Hard drive fault</li> <li>• Power Unit Redundancy sensor – Insufficient resources offset (indicates not enough power supplies present)</li> <li>• In memory non-sparing and non-mirroring mode, if the threshold of correctable errors is crossed within the window</li> <li>• In mirrored memory mode, and a correctable error takes place after memory has already lost redundancy</li> </ul>
Amber	Solid on	Critical, non-recoverable – System is halted	<p>Fatal alarm – system has failed or shutdown:</p> <ul style="list-style-type: none"> <li>• CPU CATERR signal asserted</li> <li>• MSID mismatch detected (CATERR also asserts for this case).</li> <li>• CPU 1 is missing</li> <li>• CPU Thermal Trip</li> <li>• No power good – power fault</li> <li>• DIMM failure when there is only 1 DIMM present and hence no good memory present.</li> <li>• Runtime memory uncorrectable error in non-redundant mode.</li> <li>• DIMM Thermal Trip or equivalent</li> <li>• SSB Thermal Trip or equivalent</li> <li>• CPU ERR2 signal asserted</li> <li>• BMC/Video memory test failed. (Chassis ID shows blue/solid-on for this condition)</li> <li>• Both uBoot BMC FW images are bad. (Chassis ID shows blue/solid-on for this condition)</li> <li>• 240VA fault</li> <li>• Fatal Error in processor initialization: <ul style="list-style-type: none"> <li>○ Processor family not identical</li> <li>○ Processor model not identical</li> <li>○ Processor core/thread counts not identical</li> <li>○ Processor cache size not identical</li> <li>○ Unable to synchronize processor frequency</li> <li>○ Unable to synchronize QPI link frequency</li> </ul> </li> <li>• Uncorrectable memory error in a non-redundant mode</li> </ul>

**F – Power/Sleep Button** – Toggles the system power on and off. This button also functions as a sleep button if enabled by an ACPI compliant operating system. Pressing this button will send a signal to the integrated BMC, which will either power on or power off the system. The integrated LED is a single color (Green) and is capable of supporting different indicator states as defined in the following table.

**Table 33. Power/Sleep LED Functional States**

State	Power Mode	LED	Description
Power-off	Non-ACPI	Off	System power is off, and the BIOS has not initialized the chipset.
Power-on	Non-ACPI	On	System power is on
S5	ACPI	Off	Mechanical is off, and the operating system has not saved any context to the hard disk.
S0	ACPI	Steady on	System and the operating system are up and running.

**G – Drive Activity LED** – The drive activity LED on the front panel indicates drive activity from the on-board storage controllers. The server board also provides a header giving access to this LED for add-in controllers.



## 8. Intel® Local Control Panel

The Intel® Local Control Panel option (Intel Product Order Code – **A1U2ULCP**) utilizes a combination of control buttons and LCD display to provide system accessibility and monitoring.

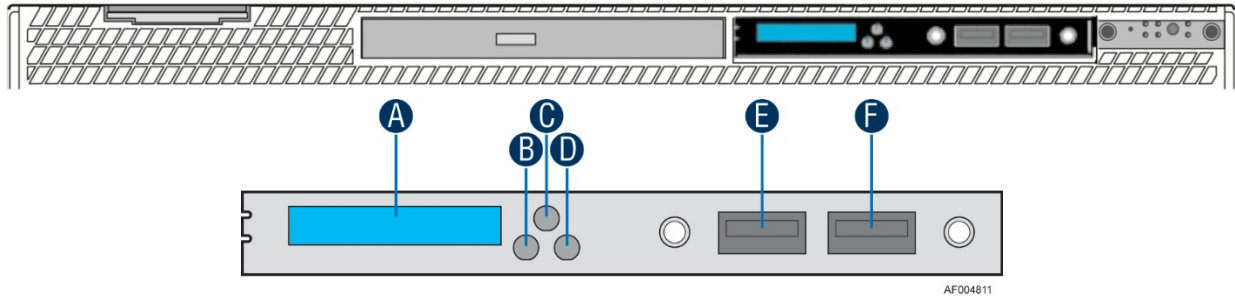

Label	Description	Functionality
A	LCD Display	one line 18 character display
B	Left Control Button	moves the cursor backward one step or one character
C	“Enter” Button	selects the menu item highlighted by the cursor
D	Right Control Button	moves the cursor forward one step or one character
E	USB 2.0/3.0 Port**	
F	USB 2.0/3.0 Port**	

**Figure 54. Intel Local Control Panel Option**

**\*\* Note:** Due to signal strength limits associated with USB 3.0 ports cabled to a front panel, some marginally compliant USB 3.0 devices may not be supported from these ports. In addition, server systems based on the Intel® Server Board S2600WT cannot be USB 3.0 certified with USB 3.0 ports cabled to a front panel.

The LCD (Local Control Display) is a one line character display that resides on the front panel of the chassis. It can display a maximum of 18 characters at a time. This device also contains 3 buttons (Left, Right and Enter). The user can select the content that needs to be displayed on the LCD screen by operating these buttons.

For a complete description of the LCP accessory, please reference the *Intel® Local Control Panel for Intel® Server Platforms Based on Intel® Xeon® Processor E5 4600/2600/2400/1600/1400 Product Families Technical Product Specification* (Intel document order number G83726-001).

## 9. PCIe\* Riser Card Support

---

The system includes two riser card slots on the server board. Available riser cards can be used in either slot. This section will provide an overview of each available riser card and describe the server board features and architecture supporting them.

The server board provides three riser card slots identified as: Riser Slot #1, Riser Slot #2, and Riser Slot #3. In a 1U system, only Riser Slot #1 and Riser Slot #2 can be used. Riser Slot #3 is for 2U system use only.

---

**Note: The riser card slots are specifically designed to support riser cards only.** Attempting to install a PCIe\* add-in card directly into a riser card slot on the server board may damage the server board, the add-in card, or both.

---

The PCIe\* bus interface for each riser card slot is supported by each of the two installed processors. The following tables provide the PCIe\* bus routing for all supported risers cards.

---

**Note:** Riser Slot #2 can only be used in dual processor configurations.

---

**Table 34. Riser Slot #1 – Riser Card Options**

1U – 1-Slot Riser Card
<p style="text-align: center;"><i>PCIe* Slot</i> CPU #1 – Port 3A (x16 elec, x16 mech)</p>

**Table 35. Riser Slot #2 – Riser Card Options**

1U – 1-Slot Riser Card
<p style="text-align: center;"><i>PCIe* Slot</i> CPU #2 – Port 2A (x16 elec, x16 mech)</p>

The system supports two single slot PCIe\* x16 (x16 lanes, x16 slot) riser cards. Each riser card is mounted to a bracket assembly which is inserted into a riser card slot on the server board.

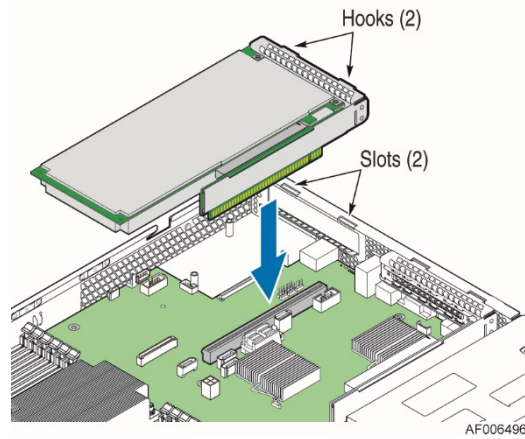

**Figure 55. Add-in Card Support**

Each riser card assembly has support for a single full height, 1/2 length PCIe\* add-in card. However, riser card #2 may be limited to 1/2 length, 1/2 height add-in cards if either of the two mini-SAS HD connectors on the server board are used or if a SATADOM storage device is installed into either of the single port SATA connectors.

---

**Note:** Add-in cards that exceed the PCI specification for 1/2 length PCI add-in cards (167.65mm or 6.6in) may interfere with other installed devices on the server board.

---

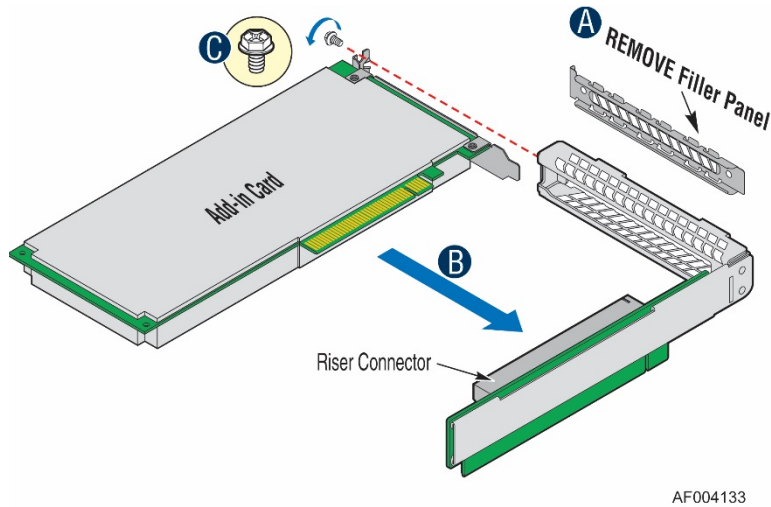

**Figure 56. Riser Card Assembly**

## 10. Intel® I/O Module Support

To broaden the standard on-board feature set, the server board provides support for one of several available Intel® I/O Module options. The I/O module attaches to a high density 80-pin connector on the server board (labeled “IO\_Module”) and is supported by x8 PCIe Gen3 signals from the IIO module of the CPU 1 processor.

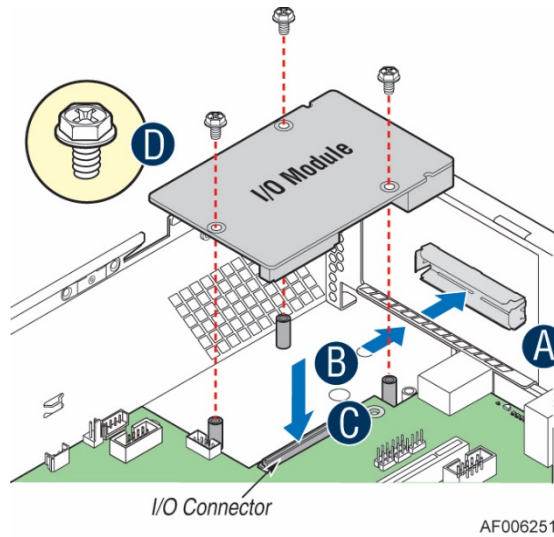

Figure 57. Intel® I/O Module Placement

Supported I/O modules include:

Table 36. Supported Intel® I/O Modules

Description	Intel Product Code
Quad port RJ45 1 GbE based on Intel® Ethernet Controller I350	Intel® I/O Module <b>AXX4P1GBPWL1OM</b>
Dual port RJ-45 10GBase-T I/O Module based on Intel® Ethernet Controller x540	Intel® I/O Module <b>AXX10GBTWLIOM3</b>
Dual port SFP+ 10 GbE module based on Intel® 82599 10 GbE controller	Intel® I/O Module <b>AXX10GBNIAIOM</b>
Single port QSFP FDR 56 GT/S speed InfiniBand* module	Intel® I/O Module <b>AXX1FDRIBIOM</b>
Dual port QSFP FDR 56 GT/S speed infiniband* module	Intel® I/O Module <b>AXX2FDRIBIOM</b>
Single port QSFP+ 40 GbE module	Intel® I/O Module <b>AXX1P40FRTIOM</b>
Dual port QSFP+ 40 GbE module	Intel® I/O Module <b>AXX2P40FRTIOM</b>

## 11. Basic and Advanced Server Management Features

The integrated BMC has support for basic and advanced server management features. Basic management features are available by default. Advanced management features are enabled with the addition of an optionally installed Remote Management Module 4 Lite (RMM4 Lite) key.

**Table 37. Intel® Remote Management Module 4 (RMM4) Options**

Intel Product Code	Description	Kit Contents	Benefits
AXXRMM4LITE	Intel® Remote Management Module 4 Lite	RMM4 Lite Activation Key	Enables KVM & media redirection

When the BMC FW initializes, it attempts to access the Intel® RMM4 lite. If the attempt to access Intel® RMM4 lite is successful, then the BMC activates the *Advanced* features.

The following table identifies both Basic and Advanced server management features.

**Table 38. Basic and Advanced Server Management Features Overview**

Feature	Basic	Advanced w/RMM4 Lite Key
IPMI 2.0 Feature Support	X	X
In-circuit BMC Firmware Update	X	X
FRB 2	X	X
Chassis Intrusion Detection	X	X
Fan Redundancy Monitoring	X	X
Hot-Swap Fan Support	X	X
Acoustic Management	X	X
Diagnostic Beep Code Support	X	X
Power State Retention	X	X
ARP/DHCP Support	X	X
PECI Thermal Management Support	X	X
E-mail Alerting	X	X
Embedded Web Server	X	X
SSH Support	X	X
Integrated KVM		X
Integrated Remote Media Redirection		X
Lightweight Directory Access Protocol (LDAP)	X	X
Intel® Intelligent Power Node Manager Support	X	X
SMASH CLP	X	X

On the server board the Intel® RMM4 Lite key is installed at the following location.

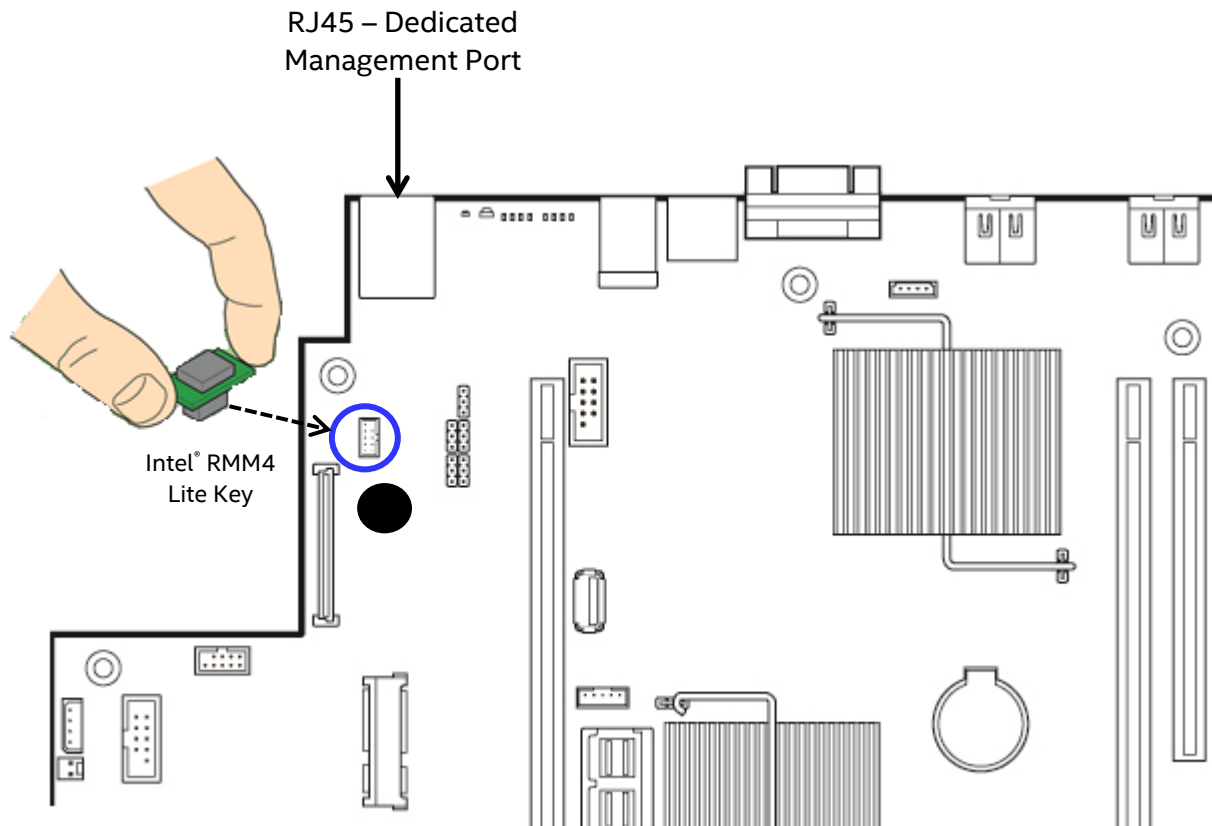

Figure 58. Intel® RMM4 Lite Activation Key Installation

### 11.1.1 Dedicated Management Port

The server board includes a dedicated 1GbE RJ45 Management Port. The management port is active with or without the RMM4 Lite key installed.

### 11.1.2 Embedded Web Server

BMC Base manageability provides an embedded web server and an OEM-customizable web GUI which exposes the manageability features of the BMC base feature set. It is supported over all on-board NICs that have management connectivity to the BMC as well as an optional dedicated add-in management NIC. At least two concurrent web sessions from up to two different users is supported. The embedded web user interface shall support the following client web browsers:

- Microsoft Internet Explorer 9.0\*
- Microsoft Internet Explorer 10.0\*
- Mozilla Firefox 24\*
- Mozilla Firefox 25\*

The embedded web user interface supports strong security (authentication, encryption, and firewall support) since it enables remote server configuration and control. The user interface presented by the embedded web user interface, shall authenticate the user before allowing a web session to be initiated. Encryption using 128-bit SSL is supported. User authentication is based on user id and password.

The GUI presented by the embedded web server authenticates the user before allowing a web session to be initiated. It presents all functions to all users but grays-out those functions that the user does not have privilege to execute. For example, if a user does not have privilege to power control, then the item shall be displayed in grey-out font in that user's UI display. The web GUI also provides a launch point for some of the advanced features, such as KVM and media redirection. These features are grayed out in the GUI unless the system has been updated to support these advanced features. The embedded web server only displays US English or Chinese language output.

Additional features supported by the web GUI includes:

- Presents all the Basic features to the users
- Power on/off/reset the server and view current power state
- Displays BIOS, BMC, ME and SDR version information
- Display overall system health.
- Configuration of various IPMI over LAN parameters for both IPV4 and IPV6
- Configuration of alerting (SNMP and SMTP)
- Display system asset information for the product, board, and chassis.
- Display of BMC-owned sensors (name, status, current reading, enabled thresholds), including color-code status of sensors.
- Provides ability to filter sensors based on sensor type (Voltage, Temperature, Fan and Power supply related)
- Automatic refresh of sensor data with a configurable refresh rate
- On-line help
- Display/clear SEL (display is in easily understandable human readable format)
- Supports major industry-standard browsers (Microsoft Internet Explorer\* and Mozilla Firefox\*)
- The GUI session automatically times-out after a user-configurable inactivity period. By default, this inactivity period is 30 minutes.
- Embedded Platform Debug feature - Allow the user to initiate a "debug dump" to a file that can be sent to Intel for debug purposes.
- Virtual Front Panel. The Virtual Front Panel provides the same functionality as the local front panel. The displayed LEDs match the current state of the local panel LEDs. The displayed buttons (for example, power button) can be used in the same manner as the local buttons.
- Display of ME sensor data. Only sensors that have associated SDRs loaded will be displayed.
- Ability to save the SEL to a file
- Ability to force HTTPS connectivity for greater security. This is provided through a configuration option in the UI.
- Display of processor and memory information as is available over IPMI over LAN.
- Ability to get and set Node Manager (NM) power policies
- Display of power consumed by the server
- Ability to view and configure VLAN settings
- Warn user the reconfiguration of IP address will cause disconnect.

- Capability to block logins for a period of time after several consecutive failed login attempts. The lock-out period and the number of failed logins that initiates the lock-out period are configurable by the user.
- Server Power Control – Ability to force into Setup on a reset
- System POST results – The web server provides the system's Power-On Self Test (POST) sequence for the previous two boot cycles, including timestamps. The timestamps may be viewed in relative to the start of POST or the previous POST code.
- Customizable ports – The web server provides the ability to customize the port numbers used for SMASH, http, https, KVM, secure KVM, remote media, and secure remote media.

For additional information, reference the Intel® Remote Management Module 4 and Integrated BMC Web Console Users Guide.

### 11.1.3 Advanced Management Feature Support (RMM4 Lite)

The integrated baseboard management controller has support for advanced management features which are enabled when an optional Intel® Remote Management Module 4 Lite (RMM4 Lite) is installed. The Intel RMM4 add-on offers convenient, remote KVM access and control through LAN and internet. It captures, digitizes, and compresses video and transmits it with keyboard and mouse signals to and from a remote computer. Remote access and control software runs in the integrated baseboard management controller, utilizing expanded capabilities enabled by the Intel RMM4 hardware.

Key Features of the RMM4 add-on are:

- KVM redirection from either the dedicated management NIC or the server board NICs used for management traffic; upto to two KVM sessions
- Media Redirection – The media redirection feature is intended to allow system administrators or users to mount a remote IDE or USB CDROM, floppy drive, or a USB flash disk as a remote device to the server. Once mounted, the remote device appears just like a local device to the server allowing system administrators or users to install software (including operating systems), copy files, update BIOS, or boot the server from this device.
- KVM – Automatically senses video resolution for best possible screen capture, high performance mouse tracking and synchronization. It allows remote viewing and configuration in pre-boot POST and BIOS setup.

#### 11.1.3.1 Keyboard, Video, Mouse (KVM) Redirection

The BMC firmware supports keyboard, video, and mouse redirection (KVM) over LAN. This feature is available remotely from the embedded web server as a Java applet. This feature is only enabled when the Intel® RMM4 lite is present. The client system must have a Java Runtime Environment (JRE) version 6.0 or later to run the KVM or media redirection applets.

The BMC supports an embedded KVM application (*Remote Console*) that can be launched from the embedded web server from a remote console. USB1.1 or USB 2.0 based mouse and keyboard redirection are supported. It is also possible to use the KVM-redirection (KVM-r) session concurrently with media-redirection (media-r). This feature allows a user to interactively use the keyboard, video, and mouse (KVM) functions of the remote server as if the user were physically at the managed server. KVM redirection console supports the following keyboard layouts: English, Dutch, French, German, Italian, Russian, and Spanish.



KVM redirection includes a “soft keyboard” function. The “soft keyboard” is used to simulate an entire keyboard that is connected to the remote system. The “soft keyboard” functionality supports the following layouts: English, Dutch, French, German, Italian, Russian, and Spanish.

The KVM-redirection feature automatically senses video resolution for best possible screen capture and provides high-performance mouse tracking and synchronization. It allows remote viewing and configuration in pre-boot POST and BIOS setup, once BIOS has initialized video.

Other attributes of this feature include:

- Encryption of the redirected screen, keyboard, and mouse
- Compression of the redirected screen.
- Ability to select a mouse configuration based on the OS type.
- Supports user definable keyboard macros.

KVM redirection feature supports the following resolutions and refresh rates:

- 640x480 at 60Hz, 72Hz, 75Hz, 85Hz, 100Hz
- 800x600 at 60Hz, 72Hz, 75Hz, 85Hz
- 1024x768 at 60Hz, 72Hz, 75Hz, 85Hz
- 1280x960 at 60Hz
- 1280x1024 at 60Hz
- 1600x1200 at 60Hz
- 1920x1080 (1080p),
- 1920x1200 (WUXGA)
- 1650x1080 (WSXGA+)

### 11.1.3.2 Remote Console

The Remote Console is the redirected screen, keyboard and mouse of the remote host system. To use the Remote Console window of your managed host system, the browser must include a Java\* Runtime Environment plug-in. If the browser has no Java support, such as with a small handheld device, the user can maintain the remote host system using the administration forms displayed by the browser.

The Remote Console window is a Java Applet that establishes TCP connections to the BMC. The protocol that is run over these connections is a unique KVM protocol and not HTTP or HTTPS. This protocol uses ports #7578 for KVM, #5120 for CDROM media redirection, and #5123 for Floppy/USB media redirection. When encryption is enabled, the protocol uses ports #7582 for KVM, #5124 for CDROM media redirection, and #5127 for Floppy/USB media redirection. The local network environment must permit these connections to be made, that is, the firewall and, in case of a private internal network, the NAT (Network Address Translation) settings have to be configured accordingly.

### 11.1.3.3 Performance

The remote display accurately represents the local display. The feature adapts to changes to the video resolution of the local display and continues to work smoothly when the system transitions from graphics to text or vice-versa. The responsiveness may be slightly delayed depending on the bandwidth and latency of the network.

Enabling KVM and/or media encryption will degrade performance. Enabling video compression provides the fastest response while disabling compression provides better video quality.

For the best possible KVM performance, a 2Mb/sec link or higher is recommended.

The redirection of KVM over IP is performed in parallel with the local KVM without affecting the local KVM operation.

#### **11.1.3.4 Security**

The KVM redirection feature supports multiple encryption algorithms, including RC4 and AES. The actual algorithm that is used is negotiated with the client based on the client's capabilities.

#### **11.1.3.5 Availability**

The remote KVM session is available even when the server is powered-off (in stand-by mode). No re-start of the remote KVM session shall be required during a server reset or power on/off. A BMC reset (for example, due to an BMC Watchdog initiated reset or BMC reset after BMC FW update) will require the session to be re-established.

KVM sessions persist across system reset, but not across an AC power loss.

#### **11.1.3.6 Usage**

As the server is powered up, the remote KVM session displays the complete BIOS boot process. The user is able interact with BIOS setup, change and save settings as well as enter and interact with option ROM configuration screens.

At least two concurrent remote KVM sessions are supported. It is possible for at least two different users to connect to same server and start remote KVM sessions.

#### **11.1.3.7 Force-enter BIOS Setup**

KVM redirection can present an option to force-enter BIOS Setup. This enables the system to enter F2 setup while booting which is often missed by the time the remote console redirects the video.

#### **11.1.3.8 Media Redirection**

The embedded web server provides a Java applet to enable remote media redirection. This may be used in conjunction with the remote KVM feature, or as a standalone applet.

The media redirection feature is intended to allow system administrators or users to mount a remote IDE or USB CD-ROM, floppy drive, or a USB flash disk as a remote device to the server. Once mounted, the remote device appears just like a local device to the server, allowing system administrators or users to install software (including operating systems), copy files, update BIOS, and so on, or boot the server from this device.

The following capabilities are supported:

- The operation of remotely mounted devices is independent of the local devices on the server. Both remote and local devices are useable in parallel.
- Either IDE (CD-ROM, floppy) or USB devices can be mounted as a remote device to the server.
- It is possible to boot all supported operating systems from the remotely mounted device and to boot from disk IMAGE (\*.IMG) and CD-ROM or DVD-ROM ISO files. See the Tested/supported Operating System List for more information.

- Media redirection supports redirection for both a virtual CD device and a virtual Floppy/USB device concurrently. The CD device may be either a local CD drive or else an ISO image file; the Floppy/USB device may be a local Floppy drive, a local USB device, or a disk image file.
- The media redirection feature supports multiple encryption algorithms, including RC4 and AES. The actual algorithm that is used is negotiated with the client based on the client's capabilities.
- A remote media session is maintained even when the server is powered-off (in standby mode). No restart of the remote media session is required during a server reset or power on/off. An BMC reset (for example, due to an BMC reset after BMC FW update) will require the session to be re-established
- The mounted device is visible to (and useable by) managed system's OS and BIOS in both pre-boot and post-boot states.
- The mounted device shows up in the BIOS boot order and it is possible to change the BIOS boot order to boot from this remote device.
- It is possible to install an operating system on a bare metal server (no OS present) using the remotely mounted device. This may also require the use of KVM-r to configure the OS during install.

USB storage devices will appear as floppy disks over media redirection. This allows for the installation of device drivers during OS installation.

If either a virtual IDE or virtual floppy device is remotely attached during system boot, both the virtual IDE and virtual floppy are presented as bootable devices. It is not possible to present only a single-mounted device type to the system BIOS.

### **11.1.3.8.1 Availability**

The default inactivity timeout is 30 minutes and is not user-configurable. Media redirection sessions persist across system reset but not across an AC power loss or BMC reset.

### **11.1.3.8.2 Network Port Usage**

The KVM and media redirection features use the following ports:

- 5120 – CD Redirection
- 5123 – FD Redirection
- 5124 – CD Redirection (Secure)
- 5127 – FD Redirection (Secure)
- 7578 – Video Redirection
- 7582 – Video Redirection (Secure)

For additional information, reference the Intel® Remote Management Module 4 and Integrated BMC Web Console Users Guide.

## Appendix A: Integration and Usage Tips

This section provides a list of useful information that is unique to the Intel® Server System R1000WT Product Family and should be kept in mind while configuring your server system.

- When adding or removing components or peripherals, power cords must be disconnected from the server. With power applied to the server, standby voltages are still present even though the server board is powered off.
- This server board supports the Intel® Xeon® Processor E5-2600 v3 and v4 product family with a Thermal Design Power (TDP) of up to and including 145 Watts. Previous generations of the Intel® Xeon® processors are not supported. Server systems using this server board may or may not meet the TDP design limits of the server board. Validate the TDP limits of the server system before selecting a processor.
- Processors must be installed in order. CPU 1 must be populated for the server board to operate
- **The riser card slots are specifically designed to support riser cards only.** Attempting to install a PCIe\* add-in card directly into a riser card slot on the server board may damage the server board, the add-in card, or both.
- This server board only supports DDR4 ECC RDIMM – Registered (Buffered) DIMMS and DDR4 ECC LRDIMM – Load Reduced DIMMs
- For the best performance, the number of DDR4 DIMMs installed should be balanced across both processor sockets and memory channels
- On the back edge of the server board are eight diagnostic LEDs that display a sequence of amber POST codes during the boot process. If the server board hangs during POST, the LEDs display the last POST event run before the hang.
- The System Status LED will be set to a steady Amber color for all Fatal Errors that are detected during processor initialization. A steady Amber System Status LED indicates that an unrecoverable system failure condition has occurred
- RAID partitions created using either embedded software RAID option, RSTe or ESRT2, cannot span across the two embedded SATA controllers. Only drives attached to a common SATA controller can be included in a RAID partition
- The FRUSDR utility must be run as part of the initial platform integration process before it is deployed into a live operating environment. Once the initial FRU and SDR data is loaded on to the system, all subsequent system configuration changes will automatically update SDR data using the BMC auto configuration feature, without having to run the FRUSDR utility again. However, to ensure the latest sensor data is installed, the SDR data should be updated to the latest available as part of a planned system software update.
- Make sure the latest system software is loaded on the server. This includes System BIOS, BMC Firmware, ME Firmware and FRUSDR. The latest system software can be downloaded from <http://downloadcenter.intel.com>.

## Appendix B: POST Code Diagnostic LED Decoder

As an aid to assist in trouble shooting a system hang that occurs during a system's Power-On Self Test (POST) process, the server board includes a bank of eight POST Code Diagnostic LEDs on the back edge of the server board.

During the system boot process, Memory Reference Code (MRC) and System BIOS execute a number of memory initialization and platform configuration processes, each of which is assigned a specific hex POST code number. As each routine is started, the given POST code number is displayed to the POST Code Diagnostic LEDs on the back edge of the server board.

During a POST system hang, the displayed post code can be used to identify the last POST routine that was run prior to the error occurring, helping to isolate the possible cause of the hang condition.

Each POST code is represented by eight LEDs; four Green and four Amber. The POST codes are divided into two nibbles, an upper nibble and a lower nibble. The upper nibble bits are represented by Amber Diagnostic LEDs #4, #5, #6, and #7. The lower nibble bits are represented by Green Diagnostics LEDs #0, #1, #2, and #3. If the bit is set in the upper and lower nibbles, the corresponding LED is lit. If the bit is clear, the corresponding LED is off.

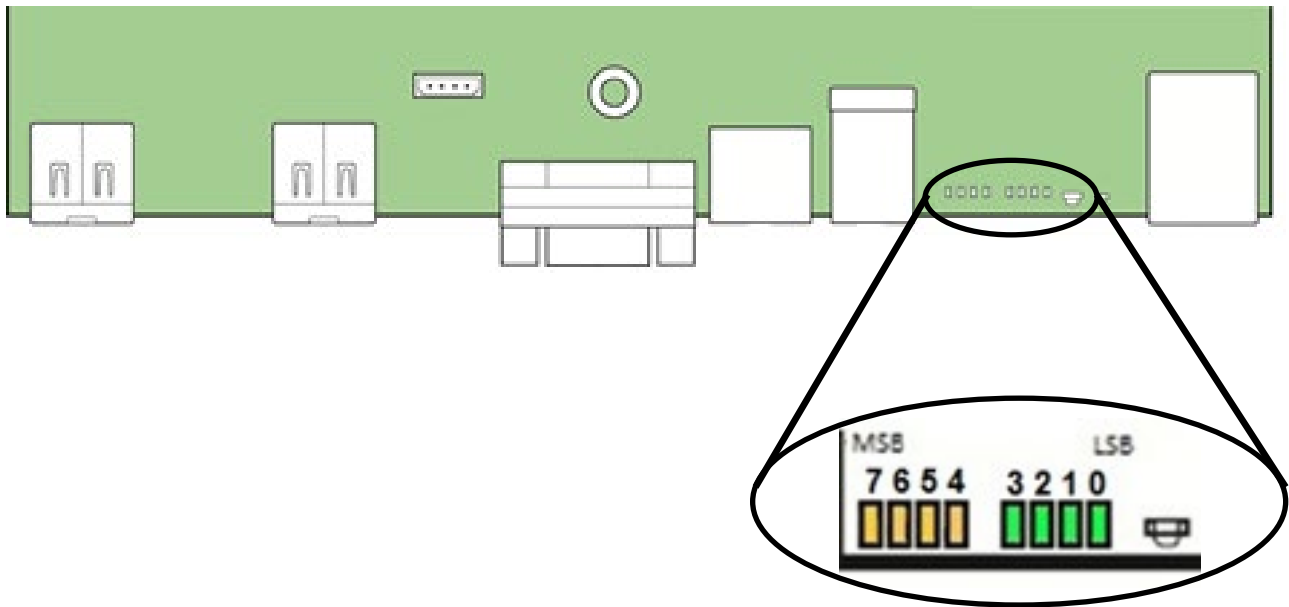

Figure 59. POST Diagnostic LED Location

In the following example, the BIOS sends a value of ACh to the diagnostic LED decoder. The LEDs are decoded as follows:

Table 39. POST Progress Code LED Example

LEDs	Upper Nibble AMBER LEDs				Lower Nibble GREEN LEDs			
	MSB							LSB
	LED #7	LED #6	LED #5	LED #4	LED #3	LED #2	LED #1	LED #0
	8h	4h	2h	1h	8h	4h	2h	1h
Status	ON	OFF	ON	OFF	ON	ON	OFF	OFF
Results	1	0	1	0	1	1	0	0
	Ah				Ch			

Upper nibble bits = 1010b = Ah; Lower nibble bits = 1100b = Ch; the two are concatenated as ACh.

## Early POST Memory Initialization MRC Diagnostic Codes

Memory Initialization at the beginning of POST includes multiple functions, including: discovery, channel training, validation that the DIMM population is acceptable and functional, initialization of the IMC and other hardware settings, and initialization of applicable RAS configurations.

The MRC Progress Codes are displays to the Diagnostic LEDs that show the execution point in the MRC operational path at each step.

**Table 40. MRC Progress Codes**

Checkpoint	Diagnostic LED Decoder								Description
	1 = LED On, 0 = LED Off								
	Upper Nibble				Lower Nibble				
	MSB							LSB	
LED	8h	4h	2h	1h	8h	4h	2h	1h	
	#7	#6	#5	#4	#3	#2	#1	#0	
MRC Progress Codes									
B0h	1	0	1	1	0	0	0	0	Detect DIMM population
B1h	1	0	1	1	0	0	0	1	Set DDR3 frequency
B2h	1	0	1	1	0	0	1	0	Gather remaining SPD data
B3h	1	0	1	1	0	0	1	1	Program registers on the memory controller level
B4h	1	0	1	1	0	1	0	0	Evaluate RAS modes and save rank information
B5h	1	0	1	1	0	1	0	1	Program registers on the channel level
B6h	1	0	1	1	0	1	1	0	Perform the JEDEC defined initialization sequence
B7h	1	0	1	1	0	1	1	1	Train DDR3 ranks
B8h	1	0	1	1	1	0	0	0	Initialize CLTT/OLTT
B9h	1	0	1	1	1	0	0	1	Hardware memory test and init
BAh	1	0	1	1	1	0	1	0	Execute software memory init
BBh	1	0	1	1	1	0	1	1	Program memory map and interleaving
BCh	1	0	1	1	1	1	0	0	Program RAS configuration
BFh	1	0	1	1	1	1	1	1	MRC is done

Should a major memory initialization error occur, preventing the system from booting with data integrity, a beep code is generated, the MRC will display a fatal error code on the diagnostic LEDs, and a system halt command is executed. Fatal MRC error halts do NOT change the state of the System Status LED, and they do NOT get logged as SEL events. The following table lists all MRC fatal errors that are displayed to the Diagnostic LEDs.

**NOTE:** Fatal MRC errors will display POST error codes that may be the same as BIOS POST progress codes displayed later in the POST process. The fatal MRC codes can be distinguished from the BIOS POST progress codes by the accompanying memory failure beep code of 3 long beeps as identified in [Table 39](#).

Table 41. MRC Fatal Error Codes

Checkpoint	Diagnostic LED Decoder								Description
	1 = LED On, 0 = LED Off								
	Upper Nibble				Lower Nibble				
	MSB							LSB	
	8h	4h	2h	1h	8h	4h	2h	1h	
LED	#7	#6	#5	#4	#3	#2	#1	#0	
MRC Fatal Error Codes									
E8h	1	1	1	0	1	0	0	0	No usable memory error 01h = No memory was detected from SPD read, or invalid config that causes no operable memory. 02h = Memory DIMMs on all channels of all sockets are disabled due to hardware memtest error. 3h = No memory installed. All channels are disabled.
E9h	1	1	1	0	1	0	0	1	Memory is locked by Intel Trusted Execution Technology and is inaccessible
EAh	1	1	1	0	1	0	1	0	DDR3 channel training error 01h = Error on read DQ/DQS (Data/Data Strobe) init 02h = Error on Receive Enable 3h = Error on Write Leveling 04h = Error on write DQ/DQS (Data/Data Strobe)
EBh	1	1	1	0	1	0	1	1	Memory test failure 01h = Software memtest failure. 02h = Hardware memtest failed. 03h = Hardware Memtest failure in Lockstep Channel mode requiring a channel to be disabled. <i>This is a fatal error which requires a reset and calling MRC with a different RAS mode to retry.</i>
EDh	1	1	1	0	1	1	0	1	DIMM configuration population error 01h = Different DIMM types (UDIMM, RDIMM, LRDIMM) are detected installed in the system. 02h = Violation of DIMM population rules. 03h = The 3rd DIMM slot cannot be populated when QR DIMMs are installed. 04h = UDIMMs are not supported in the 3rd DIMM slot. 05h = Unsupported DIMM Voltage.
EFh	1	1	1	0	1	1	1	1	Indicates a CLTT table structure error

## Appendix C: POST Code Errors

Most error conditions encountered during POST are reported using **POST Error Codes**. These codes represent specific failures, warnings, or are informational. POST Error Codes may be displayed in the Error Manager display screen, and are always logged to the System Event Log (SEL). Logged events are available to System Management applications, including Remote and Out of Band (OOB) management.

There are exception cases in early initialization where system resources are not adequately initialized for handling POST Error Code reporting. These cases are primarily Fatal Error conditions resulting from initialization of processors and memory, and they are handled by a Diagnostic LED display with a system halt. The following table lists the supported POST Error Codes. Each error code is assigned an error type which determines the action the BIOS will take when the error is encountered. Error types include Minor, Major, and Fatal. The BIOS action for each is defined as follows:

- **Minor:** The error message is displayed on the screen or on the Error Manager screen, and an error is logged to the SEL. The system continues booting in a degraded state. The user may want to replace the erroneous unit. The POST Error Pause option setting in the BIOS setup does not have any effect on this error.
- **Major:** The error message is displayed on the Error Manager screen, and an error is logged to the SEL. The POST Error **Pause** option setting in the BIOS setup determines whether the system pauses to the Error Manager for this type of error so the user can take immediate corrective action or the system continues booting.

Note that for 0048 “Password check failed”, the system halts, and then after the next reset/reboot will display the error code on the Error Manager screen.

- **Fatal:** The system halts during post at a blank screen with the text **“Unrecoverable fatal error found. System will not boot until the error is resolved”** and **“Press <F2> to enter setup”**. The POST Error Pause option setting in the BIOS setup does not have any effect with this class of error.

When the operator presses the **F2** key on the keyboard, the error message is displayed on the Error Manager screen, and an error is logged to the SEL with the error code. The system cannot boot unless the error is resolved. The user needs to replace the faulty part and restart the system.

---

**Note:** The POST error codes in the following table are common to all current generation Intel server platforms. Features present on a given server board/system will determine which of the listed error codes are supported

---

**Table 42. POST Error Messages and Handling**

Error Code	Error Message	Response
0012	System RTC date/time not set	Major
0048	Password check failed	Major
0140	PCI component encountered a PERR error	Major
0141	PCI resource conflict	Major
0146	PCI out of resources error	Major
0191	Processor core/thread count mismatch detected	Fatal
0192	Processor cache size mismatch detected	Fatal
0194	Processor family mismatch detected	Fatal



**Intel® Server System R1000WT Family TPS**

<b>Error Code</b>	<b>Error Message</b>	<b>Response</b>
0195	Processor Intel(R) QPI link frequencies unable to synchronize	Fatal
0196	Processor model mismatch detected	Fatal
0197	Processor frequencies unable to synchronize	Fatal
5220	BIOS Settings reset to default settings	Major
5221	Passwords cleared by jumper	Major
5224	Password clear jumper is Set	Major
8130	Processor 01 disabled	Major
8131	Processor 02 disabled	Major
8160	Processor 01 unable to apply microcode update	Major
8161	Processor 02 unable to apply microcode update	Major
8170	Processor 01 failed Self Test (BIST)	Major
8171	Processor 02 failed Self Test (BIST)	Major
8180	Processor 01 microcode update not found	Minor
8181	Processor 02 microcode update not found	Minor
8190	Watchdog timer failed on last boot	Major
8198	OS boot watchdog timer failure	Major
8300	Baseboard management controller failed self test	Major
8305	Hot Swap Controller failure	Major
83A0	Management Engine (ME) failed self test	Major
83A1	Management Engine (ME) Failed to respond.	Major
84F2	Baseboard management controller failed to respond	Major
84F3	Baseboard management controller in update mode	Major
84F4	Sensor data record empty	Major
84FF	System event log full	Minor
8500	Memory component could not be configured in the selected RAS mode	Major
8501	DIMM Population Error	Major
8520	DIMM_A1 failed test/initialization	Major
8521	DIMM_A2 failed test/initialization	Major
8522	DIMM_A3 failed test/initialization	Major
8523	DIMM_B1 failed test/initialization	Major
8524	DIMM_B2 failed test/initialization	Major
8525	DIMM_B3 failed test/initialization	Major
8526	DIMM_C1 failed test/initialization	Major
8527	DIMM_C2 failed test/initialization	Major
8528	DIMM_C3 failed test/initialization	Major
8529	DIMM_D1 failed test/initialization	Major
852A	DIMM_D2 failed test/initialization	Major
852B	DIMM_D3 failed test/initialization	Major
852C	DIMM_E1 failed test/initialization	Major
852D	DIMM_E2 failed test/initialization	Major
852E	DIMM_E3 failed test/initialization	Major
852F	DIMM_F1 failed test/initialization	Major
8530	DIMM_F2 failed test/initialization	Major
8531	DIMM_F3 failed test/initialization	Major
8532	DIMM_G1 failed test/initialization	Major
8533	DIMM_G2 failed test/initialization	Major

**Intel® Server System R1000WT Family TPS**

<b>Error Code</b>	<b>Error Message</b>	<b>Response</b>
8534	DIMM_G3 failed test/initialization	Major
8535	DIMM_H1 failed test/initialization	Major
8536	DIMM_H2 failed test/initialization	Major
8537	DIMM_H3 failed test/initialization	Major
8538	DIMM_J1 failed test/initialization	Major
8539	DIMM_J2 failed test/initialization	Major
853A	DIMM_J3 failed test/initialization	Major
853B	DIMM_K1 failed test/initialization	Major
853C	DIMM_K2 failed test/initialization	Major
853D	DIMM_K3 failed test/initialization	Major
853E	DIMM_L1 failed test/initialization	Major
853F (Go to 85C0)	DIMM_L2 failed test/initialization	Major
8540	DIMM_A1 disabled	Major
8541	DIMM_A2 disabled	Major
8542	DIMM_A3 disabled	Major
8543	DIMM_B1 disabled	Major
8544	DIMM_B2 disabled	Major
8545	DIMM_B3 disabled	Major
8546	DIMM_C1 disabled	Major
8547	DIMM_C2 disabled	Major
8548	DIMM_C3 disabled	Major
8549	DIMM_D1 disabled	Major
854A	DIMM_D2 disabled	Major
854B	DIMM_D3 disabled	Major
854C	DIMM_E1 disabled	Major
854D	DIMM_E2 disabled	Major
854E	DIMM_E3 disabled	Major
854F	DIMM_F1 disabled	Major
8550	DIMM_F2 disabled	Major
8551	DIMM_F3 disabled	Major
8552	DIMM_G1 disabled	Major
8553	DIMM_G2 disabled	Major
8554	DIMM_G3 disabled	Major
8555	DIMM_H1 disabled	Major
8556	DIMM_H2 disabled	Major
8557	DIMM_H3 disabled	Major
8558	DIMM_J1 disabled	Major
8559	DIMM_J2 disabled	Major
855A	DIMM_J3 disabled	Major
855B	DIMM_K1 disabled	Major
855C	DIMM_K2 disabled	Major
855D	DIMM_K3 disabled	Major
855E	DIMM_L1 disabled	Major

**Intel® Server System R1000WT Family TPS**

<b>Error Code</b>	<b>Error Message</b>	<b>Response</b>
855F (Go to 85D0)	DIMM_L2 disabled	Major
8560	DIMM_A1 encountered a Serial Presence Detection (SPD) failure	Major
8561	DIMM_A2 encountered a Serial Presence Detection (SPD) failure	Major
8562	DIMM_A3 encountered a Serial Presence Detection (SPD) failure	Major
8563	DIMM_B1 encountered a Serial Presence Detection (SPD) failure	Major
8564	DIMM_B2 encountered a Serial Presence Detection (SPD) failure	Major
8565	DIMM_B3 encountered a Serial Presence Detection (SPD) failure	Major
8566	DIMM_C1 encountered a Serial Presence Detection (SPD) failure	Major
8567	DIMM_C2 encountered a Serial Presence Detection (SPD) failure	Major
8568	DIMM_C3 encountered a Serial Presence Detection (SPD) failure	Major
8569	DIMM_D1 encountered a Serial Presence Detection (SPD) failure	Major
856A	DIMM_D2 encountered a Serial Presence Detection (SPD) failure	Major
856B	DIMM_D3 encountered a Serial Presence Detection (SPD) failure	Major
856C	DIMM_E1 encountered a Serial Presence Detection (SPD) failure	Major
856D	DIMM_E2 encountered a Serial Presence Detection (SPD) failure	Major
856E	DIMM_E3 encountered a Serial Presence Detection (SPD) failure	Major
856F	DIMM_F1 encountered a Serial Presence Detection (SPD) failure	Major
8570	DIMM_F2 encountered a Serial Presence Detection (SPD) failure	Major
8571	DIMM_F3 encountered a Serial Presence Detection (SPD) failure	Major
8572	DIMM_G1 encountered a Serial Presence Detection (SPD) failure	Major
8573	DIMM_G2 encountered a Serial Presence Detection (SPD) failure	Major
8574	DIMM_G3 encountered a Serial Presence Detection (SPD) failure	Major
8575	DIMM_H1 encountered a Serial Presence Detection (SPD) failure	Major
8576	DIMM_H2 encountered a Serial Presence Detection (SPD) failure	Major
8577	DIMM_H3 encountered a Serial Presence Detection (SPD) failure	Major
8578	DIMM_J1 encountered a Serial Presence Detection (SPD) failure	Major
8579	DIMM_J2 encountered a Serial Presence Detection (SPD) failure	Major
857A	DIMM_J3 encountered a Serial Presence Detection (SPD) failure	Major
857B	DIMM_K1 encountered a Serial Presence Detection (SPD) failure	Major
857C	DIMM_K2 encountered a Serial Presence Detection (SPD) failure	Major
857D	DIMM_K3 encountered a Serial Presence Detection (SPD) failure	Major
857E	DIMM_L1 encountered a Serial Presence Detection (SPD) failure	Major
857F (Go to 85E0)	DIMM_L2 encountered a Serial Presence Detection (SPD) failure	Major
85C0	DIMM_L3 failed test/initialization	Major
85C1	DIMM_M1 failed test/initialization	Major
85C2	DIMM_M2 failed test/initialization	Major
85C3	DIMM_M3 failed test/initialization	Major
85C4	DIMM_N1 failed test/initialization	Major
85C5	DIMM_N2 failed test/initialization	Major
85C6	DIMM_N3 failed test/initialization	Major
85C7	DIMM_P1 failed test/initialization	Major
85C8	DIMM_P2 failed test/initialization	Major
85C9	DIMM_P3 failed test/initialization	Major

**Intel® Server System R1000WT Family TPS**

<b>Error Code</b>	<b>Error Message</b>	<b>Response</b>
85CA	DIMM_R1 failed test/initialization	Major
85CB	DIMM_R2 failed test/initialization	Major
85CC	DIMM_R3 failed test/initialization	Major
85CD	DIMM_T1 failed test/initialization	Major
85CE	DIMM_T2 failed test/initialization	Major
85CF	DIMM_T3 failed test/initialization	Major
85D0	DIMM_L3 disabled	Major
85D1	DIMM_M1 disabled	Major
85D2	DIMM_M2 disabled	Major
85D3	DIMM_M3 disabled	Major
85D4	DIMM_N1 disabled	Major
85D5	DIMM_N2 disabled	Major
85D6	DIMM_N3 disabled	Major
85D7	DIMM_P1 disabled	Major
85D8	DIMM_P2 disabled	Major
85D9	DIMM_P3 disabled	Major
85DA	DIMM_R1 disabled	Major
85DB	DIMM_R2 disabled	Major
85DC	DIMM_R3 disabled	Major
85DD	DIMM_T1 disabled	Major
85DE	DIMM_T2 disabled	Major
85DF	DIMM_T3 disabled	Major
85E0	DIMM_L3 encountered a Serial Presence Detection (SPD) failure	Major
85E1	DIMM_M1 encountered a Serial Presence Detection (SPD) failure	Major
85E2	DIMM_M2 encountered a Serial Presence Detection (SPD) failure	Major
85E3	DIMM_M3 encountered a Serial Presence Detection (SPD) failure	Major
85E4	DIMM_N1 encountered a Serial Presence Detection (SPD) failure	Major
85E5	DIMM_N2 encountered a Serial Presence Detection (SPD) failure	Major
85E6	DIMM_N3 encountered a Serial Presence Detection (SPD) failure	Major
85E7	DIMM_P1 encountered a Serial Presence Detection (SPD) failure	Major
85E8	DIMM_P2 encountered a Serial Presence Detection (SPD) failure	Major
85E9	DIMM_P3 encountered a Serial Presence Detection (SPD) failure	Major
85EA	DIMM_R1 encountered a Serial Presence Detection (SPD) failure	Major
85EB	DIMM_R2 encountered a Serial Presence Detection (SPD) failure	Major
85EC	DIMM_R3 encountered a Serial Presence Detection (SPD) failure	Major
85ED	DIMM_T1 encountered a Serial Presence Detection (SPD) failure	Major
85EE	DIMM_T2 encountered a Serial Presence Detection (SPD) failure	Major
85EF	DIMM_T3 encountered a Serial Presence Detection (SPD) failure	Major
8604	POST Reclaim of non-critical NVRAM variables	Minor
8605	BIOS Settings are corrupted	Major
8606	NVRAM variable space was corrupted and has been reinitialized	Major
8607	Recovery boot has been initiated. Note: The Primary BIOS image may be corrupted or the system may hang during POST. A BIOS update is required.	Fatal
92A3	Serial port component was not detected	Major
92A9	Serial port component encountered a resource conflict error	Major

Error Code	Error Message	Response
A000	TPM device not detected.	Minor
A001	TPM device missing or not responding.	Minor
A002	TPM device failure.	Minor
A003	TPM device failed self test.	Minor
A100	BIOS ACM Error	Major
A421	PCI component encountered a SERR error	Fatal
A5A0	PCI Express component encountered a PERR error	Minor
A5A1	PCI Express component encountered an SERR error	Fatal
A6A0	DXE Boot Services driver: Not enough memory available to shadow a Legacy Option ROM.	Minor

## POST Error Beep Codes

The following table lists the POST error beep codes. Prior to system video initialization, the BIOS uses these beep codes to inform users on error conditions. The beep code is followed by a user-visible code on the POST Progress LEDs.

**Table 43. POST Error Beep Codes**

Beeps	Error Message	POST Progress Code	Description
1	USB device action	N/A	Short beep sounded whenever USB device is discovered in POST, or inserted or removed during runtime.
1 long	Intel® TXT security violation	0xAE, 0xAF	System halted because Intel® Trusted Execution Technology detected a potential violation of system security.
3	Memory error	Multiple	System halted because a fatal error related to the memory was detected.
3 long and 1	CPU mismatch error	0xE5, 0xE6	System halted because a fatal error related to the CPU family/core/cache mismatch was detected.
<b>The following Beep Codes are sounded during BIOS Recovery.</b>			
2	Recovery started	N/A	Recovery boot has been initiated.
4	Recovery failed	N/A	Recovery has failed. This typically happens so quickly after recovery is initiated that it sounds like a 2-4 beep code.

The Integrated BMC may generate beep codes upon detection of failure conditions. Beep codes are sounded each time the problem is discovered, such as on each power-up attempt, but are not sounded continuously. Codes that are common across all Intel server boards and systems that use same generation chipset are listed in the following table. Each digit in the code is represented by a sequence of beeps whose count is equal to the digit.

**Table 44. Integrated BMC Beep Codes**

<b>Code</b>	<b>Associated Sensors</b>	<b>Reason for Beep</b>
1-5-2-1	No CPUs installed or first CPU socket is empty.	CPU1 socket is empty, or sockets are populated incorrectly CPU1 must be populated before CPU2.
1-5-2-4	MSID Mismatch	MSID mismatch occurs if a processor is installed into a system board that has incompatible power capabilities.
1-5-4-2	Power fault	DC power unexpectedly lost (power good dropout) – Power unit sensors report power unit failure offset
1-5-4-4	Power control fault (power good assertion timeout).	Power good assertion timeout – Power unit sensors report soft power control failure offset
1-5-1-2	VR Watchdog Timer sensor assertion	VR controller DC power on sequence was not completed in time.
1-5-1-4	Power Supply Status	The system does not power on or unexpectedly powers off and a Power Supply Unit (PSU) is present that is an incompatible model with one or more other PSUs in the system.

## Appendix D: System Configuration Table for Thermal Compatibility

This section provides system configuration compatibility data based on various supported system operating thermal limits. Two tables are provided. The first table identifies supported system configurations while the system is in “normal” operating mode; all systems fans are present, on-line, and operational. The second table identifies supported system configurations while the system is in a “fan fail” mode; one system fan or system fan rotor, is no longer on-line or operational, fan redundancy is lost.

The following notes communicate support criteria associated with specific configurations identified in the following tables. Each relevant note to a configuration is identified by reference number in the table. Listed notes that are not specified in the table will reflect support criteria for a similar 2U based system within the Intel® Server Board S2600WT product family, details of which can be found in the Intel® Server System R2000WT Technical Product Specification.

### Thermal Configuration Table Notes:

1. The 27°C configuration alone is limited to elevations of 900m or less. Altitudes higher than 900m need to be de-rated to ASHRAE Class 2 levels.
2. To support system fan redundancy, the system must be configured with two power supplies to maintain sufficient cooling. Concurrent system and power supply fan failures is not supported.
3. Processor throttling may occur which may impact system performance. CPU reliability is not impacted
4. In fan fail mode, Intel® I/O Modules AXX10GBTWLIOM and AXX2FDRIBIOM are only supported in the specified base system model configured with 120W processors and DRx4 memory.
5. Use of the designated PCIe\* slot is limited to add-in cards that have air flow requirements of 100 LFM or less. See add-in card specs for air flow requirements.
6. For ASHRAE Class 3 and Class 4 support, the following power supply margining is required to meet thermal specifications:
  - a) For dual power supply configurations, the power budget must fit within a single power supply rated load and be installed in a dual configuration, or
  - b) For single power supply configurations, the power budget must be sized with 30% margin to single power supply rated load.
7. Intel® Xeon Phi™ or non-Intel GPGPU cards may have performance impact during ASHRAE Class 3 and Class 4 ambient air excursions
8. PCIe\* SSD AIC SFF devices can only be supported in the top add-in card slot on Riser Slot #1 and Riser Slot #2.
9. The Intel® RAID Maintenance Free Backup Unit (AXXRMFBUX) can support a case temperature of up to 45°C with the system operating in normal mode and up to 55°C with the system operating in a fan fail mode. The case temperature of Intel® Smart RAID Battery (AXXRSBBUX) can support up to 45°C in both normal and fan fail mode. Excursions over these specs may result in a reliability impact.
10. The 2U system must be configured with Intel® accessory kits **AWTCOPRODUCT** and **A2UL16RISER2** in order to support Intel® Xeon Phi™ or Non-Intel GPGPU add-in cards with passive cooling solutions.

## Thermal Configuration Table – System in “Normal” Operating Mode

"•" = Full Support without limitation

"4,5" (Cell with number) = Conditional support for configuration with limitations. See notes Section

" " (Blank Cell) = Configuration Not supported

		Intel® Server System Base System Models: R1304WTxxxx R1208WTxxxx			
ASHRAE (See note 1)	Classifications	27C	A2	A3	A4
	Max Ambient	27°C (1)	35° C	40° C	45° C
PS (See note 6)	1100W AC	•	•	•	•
	750W AC	•	•	•	•
	750W DC	•	•	•	•
EP Processors ( See Notes 3)	EP, 135w, 12C (Intel® Xeon® processor E5-2690 V3)	•	•	•	•
	EP, 120w, 12C (Intel® Xeon® processor E5-2680 V3, E5-2670 V3)	•	•	•	•
	EP, 105w, 10C (Intel® Xeon® processor E5-2660 V3, E5-2650 V3)	•	•	•	•
	EP, 90w, 8C (Intel® Xeon® processor E5-2640 V3)	•	•	•	•
	EP, 85w,8C,6C (Intel® Xeon® processor E5-2630 V3E5-2620 V3, E5-2609 V3, E5-2603 V3)	•	•	•	•
	EP, 135w, 8C,6C,4C (Intel® Xeon® processor E5-2667 V3, E5-2643 V3, E5-2637 V3)	•	•	3	3
	EP, 105w, 4C (Intel® Xeon® processor E5-2623 V3)	•	•	•	•
	EP, 65w, 12C (Intel® Xeon® processor E5-2650L V3)	•	•	•	3
	EP, 55w, 8C (Intel® Xeon® processor E5-2630L V3)	•	•	•	3
	EP, 145w, 14C,18C (Intel® Xeon® processor E5-2697 V3, E5-2699 V3)	•	•	3	3
	EP, 135w, 16C (Intel® Xeon® processor E5-2698 V3)	•	•	•	•
EP, 120w, 14C (Intel® Xeon® processor E5-2695 V3, E5-2683 V3)	•	•	•	•	
Memory Type	RDIMM-2Rx8,1Rx4, 1Rx8	•	•	•	•
	RDIMM-DRx4	•	•	•	•
	LRDIMM-QRx4 DDP	•	•	•	•
Add-in Cards (See note 5)	Riser #1 - Bottom Slot (1U riser and 2U riser)	•	•	•	•
	Riser #1 - Middle Slot (2U riser)				
	Riser #1 - Top Slot (2U riser)				
	Riser #2 - Bottom Slot (1U riser and 2U riser)	•	•	•	•
	Riser #2 - Middle Slot (2U riser)				
	Riser #2 - Top Slot (2U riser)				
3rd PCI Riser	Riser #3 - Bottom Slot				
	Riser #3 - Top Slot				
SAS and I/O Modules (See Note 4)	Intel® Integrated RAID Modules (Mezzanine cards)	•	•	•	•
	AXX10GBTWLIOM - Dual 10GBASE-T IO Module	•	•	•	•
	AXX10GBNIAIOM - Dual SFP+ port 10GbE IO Module	•	•	•	•
	AXX1FDRIBIOM - Single Port FDR Infiniband IO Module	•	•	•	•
	AXX2FDRIBIOM - Dual Port FDR Infiniband IO Module	•	•	•	•
	AXX4P1GBPWL IOM - Quad Port 1GbE IO Module	•	•	•	•
	AXX1P40FRTIOM - Single Port 40GbE IO Module	•	•	•	•
	AXX2P40FRTIOM - Dual Port 40GbE IO Module	•	•	•	•
Battery Backup (See note 9)	AXXRSBBUx (rated to 45C)	•	•	•	
	AXXRMFBUx (rated to 55C)	•	•	•	
	Cache Offload Module (rated to 55C)	•	•	•	•



**Intel® Server System R1000WT Family TPS**

		Intel® Server System Base System Models: R1304WTxxxx R1208WTxxxx			
ASHRAE (See note 1)	Classifications	27C	A2	A3	A4
	Max Ambient	27°C (1)	35° C	40° C	45° C
Internal SSD	Rated to 60C				
	Rated to 70C				
Rear SSD	Rated to 60C				
	Rated to 70C				
PCIe* SFF SSD (DC P3700/P3500)	1600GB/2TB	•	•	•	•
	800GB	•	•	•	•
	600GB	•	•	•	•
	400GB	•	•	•	•
	200GB	•	•	•	•
PCIe* SSD AIC FF (DC P3700/P3500) (See note 8)	1600GB/2TB	•	•	•	•
	800GB	•	•	•	•
	600GB	•	•	•	•
	400GB	•	•	•	•
	200GB	•	•	•	•
Intel® Xeon Phi™ (See Note 7, 10)	Active Cooling up to 300W				
	Active Cooling up to 225W				
	Intel® Xeon Phi™ w/Passive Cooling up to 225W				
	Intel® Xeon Phi™ w/Passive Cooling up to 245W				
	Intel® Xeon Phi™ w/Passive Cooling up to 300W				

## Thermal Configuration Table – System in “Fan Fail” Operating Mode

"●" = Full Support without limitation

"4,5" (Cell with number) = Conditional support for configuration with limitations. See notes Section

" " (Blank Cell) = Configuration Not supported

		Base System SKUs: R1304WTxxxx R1208WTxxxx			
ASHRAE (See note 1)	Classifications	27C	A2	A3	A4
	Max Ambient	27°C (1)	35° C	40° C	45° C
PS (See note 6)	1100W AC	2	2		
	750W AC	2	2		
	750W DC	2	2		
EP Processors ( See Notes 3)	EP, 135w, 12C (Intel® Xeon® processor E5-2690 V3)	●	●		
	EP, 120w, 12C (Intel® Xeon® processor E5-2680 V3, E5-2670 V3 )	●	●		
	EP, 105w, 10C (Intel® Xeon® processor E5-2660 V3, E5-2650 V3)	●	●		
	EP, 90w, 8C (Intel® Xeon® processor E5-2640 V3)	●	●		
	EP, 85w,8C,6C (Intel® Xeon® processor E5-2630 V3, E5-2620 V3, E5-2609 V3, E5-2603 V3)	●	●		
	EP, 135w, 8C,6C,4C (Intel® Xeon® processor E5-2667 V3, E5-2643 V3, E5-2637 V3)	3	3		
	EP, 105w, 4C (Intel® Xeon® processor E5-2623 V3)	●	●		
	EP, 65w, 12C (Intel® Xeon® processor E5-2650L V3)	●	●		
	EP, 55w, 8C (Intel® Xeon® processor E5-2630L V3)	●	●		
	EP, 145w, 14C,18C (Intel® Xeon® processor E5-2697 V3, E5-2699 V3)	3	3		
	EP, 135w, 16C (Intel® Xeon® processor E5-2698 V3)	●	●		
EP, 120w, 14C (Intel® Xeon® processor E5-2695 V3, E5-2683 V3)	●	●			
Memory Type	RDIMM-2Rx8,1Rx4	●	●		
	RDIMM-DRx4	●	●		
	LRDIMM-QRx4 DDP	●	●		
Add-in Cards (See note 5)	Riser #1 - Bottom Slot (1U riser and 2U riser)	●	●		
	Riser #1 - Middle Slot (2U riser)				
	Riser #1 - Top Slot (2U riser)				
	Riser #2 - Bottom Slot (1U riser and 2U riser)	●	●		
	Riser #2 - Middle Slot (2U riser)				
	Riser #2 - Top Slot (2U riser)				
3rd PCI Riser	Riser #3 - Bottom Slot				
	Riser #3 - Top Slot				
SAS and I/O Modules (See Note 4)	Intel® Integrated RAID Modules (Mezzanine cards)	●	●		
	AXX10GBTWLIOM - Dual 10GBASE-T IO Module	●	●		
	AXX10GBNIAIOM - Dual SFP+ port 10GbE IO Module	●	●		
	AXX1FDRIBIOM - Single Port FDR Infiniband IO Module	●	●		
	AXX2FDRIBIOM - Dual Port FDR Infiniband IO Module	●	●		
	AXX4P1GBPWL IOM - Quad Port 1GbE IO Module	●	●		
	AXX1P40FRTIOM - Single Port 40GbE IO Module	●	●		
	AXX2P40FRTIOM - Dual Port 40GbE IO Module	●	●		
Battery Backup (See note 9)	AXXRSBBUx (rated to 45C)	●	●		
	AXXRMFBUx (rated to 55C)	●	●		
	Cache Offload Module (rated to 55C)	●	●		

**Intel® Server System R1000WT Family TPS**

		Base System SKUs: R1304WTxxxx R1208WTxxxx			
ASHRAE (See note 1)	Classifications	27C	A2	A3	A4
	Max Ambient	27°C (1)	35° C	40° C	45° C
Internal SSD	Rated to 60C				
	Rated to 70C				
Rear SSD	Rated to 60C				
	Rated to 70C				
PCIe* SFF SSD (DC P3700/P3500)	1600GB/2TB	•	•		
	800GB	•	•		
	600GB	•	•		
	400GB	•	•		
	200GB	•	•		
PCIe* SSD AIC FF (DC P3700/P3500) (See note 8)	1600GB/2TB	•	•		
	800GB	•	•		
	600GB	•	•		
	400GB	•	•		
	200GB	•	•		
Intel® Xeon Phi™ (See Note 7, 10)	Active Cooling up to 300W				
	Active Cooling up to 225W				
	Intel® Xeon Phi™ w/Passive Cooling up to 225W				
	Intel® Xeon Phi™ w/Passive Cooling up to 245W				
	Intel® Xeon Phi™ w/Passive Cooling up to 300W				

# Appendix E: System Cable Routing Diagrams

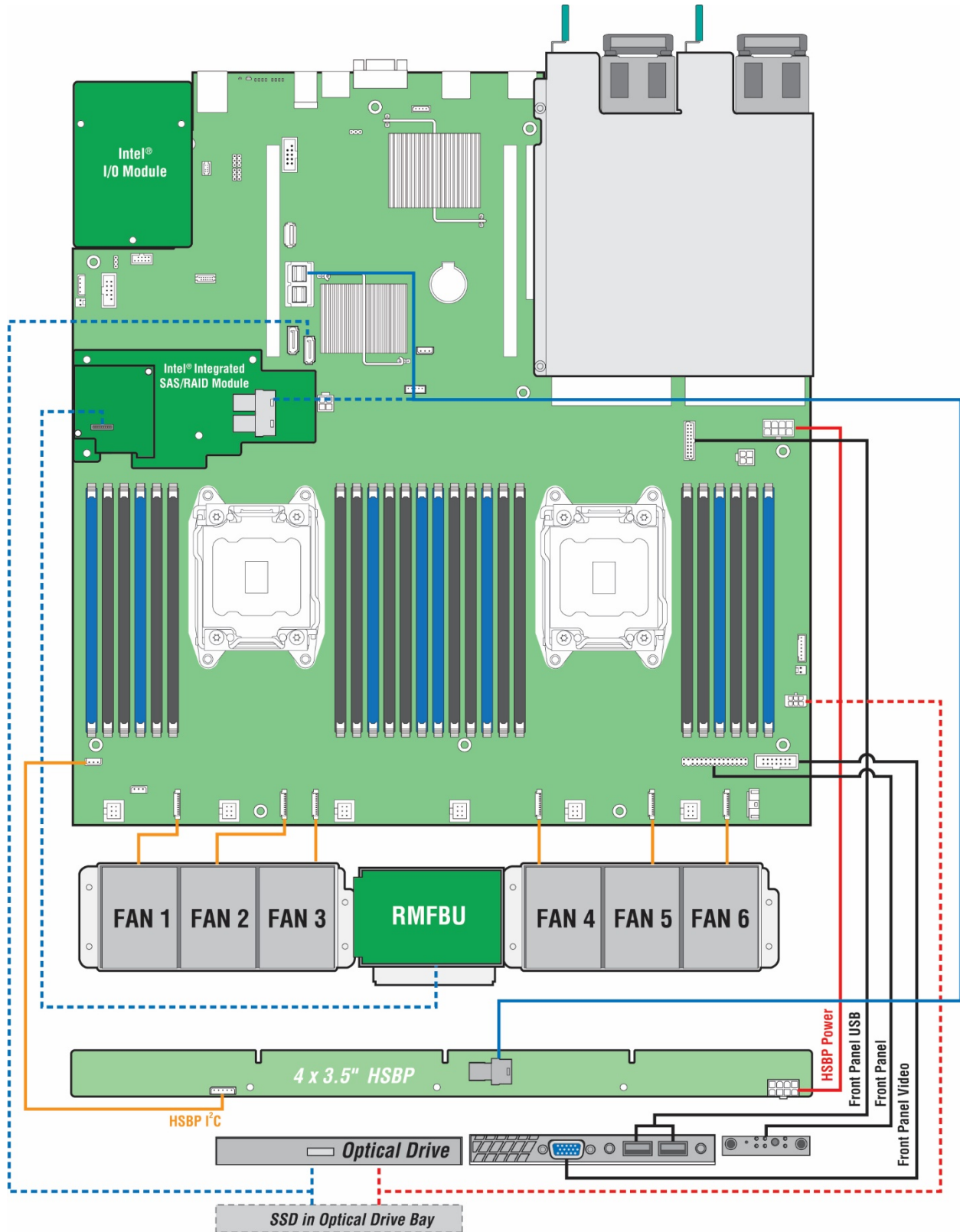

- Power Cable
- - - Power Cable (Accessory)
- SAS/SATA Cable
- - - SAS/SATA/RMFBU Cable (Accessory)
- I<sup>2</sup>C/SGPIO Cable
- - - I<sup>2</sup>C/SGPIO Cable (Accessory)
- Front Control Panel and I/O Cable

# Intel® Server System R1000WT Family TPS

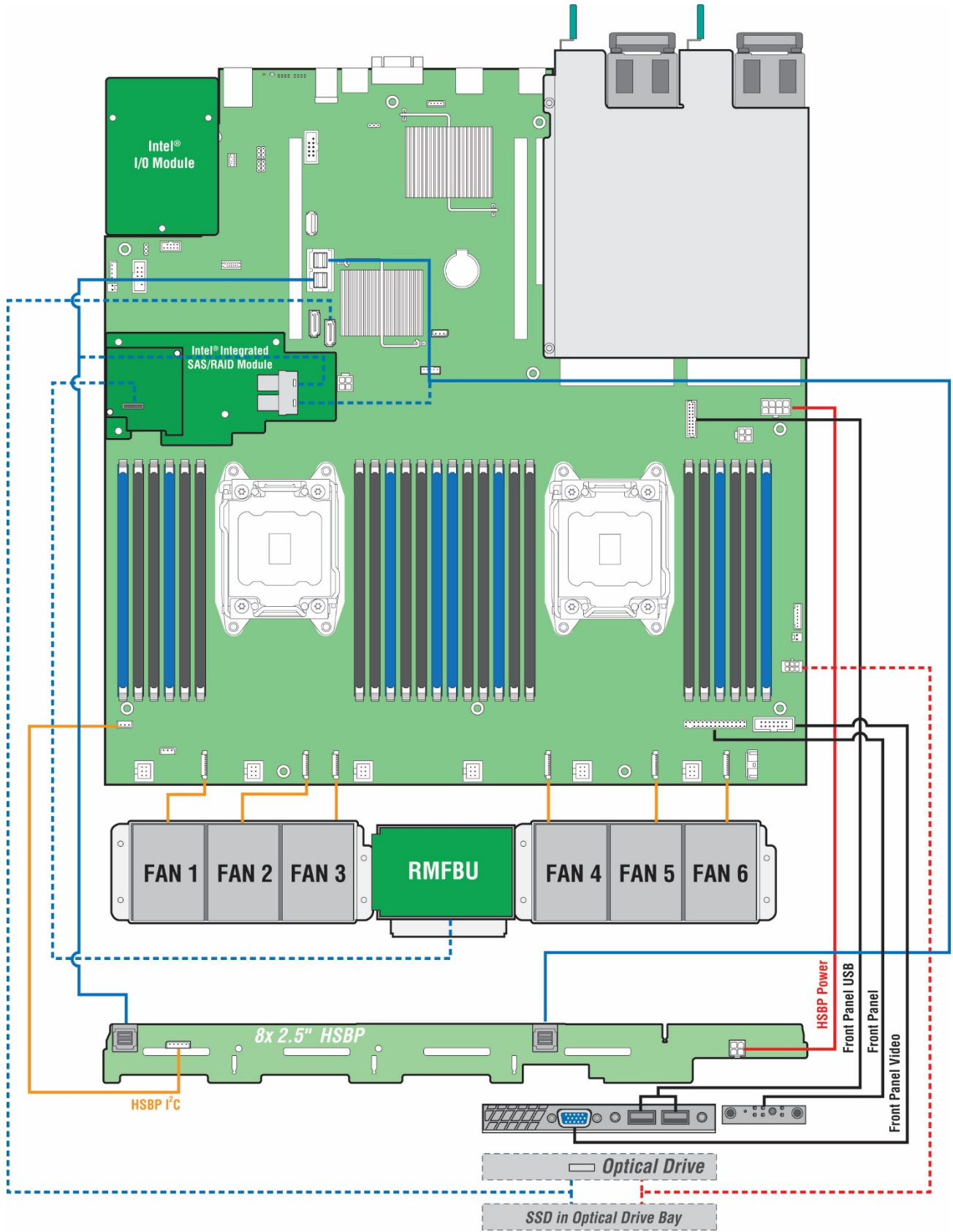

- Power Cable
- - - Power Cable (Accessory)
- SAS/SATA Cable
- - - SAS/SATA/RMFBU Cable (Accessory)
- I<sup>2</sup>C/SGPIO Cable
- - - I<sup>2</sup>C/SGPIO Cable (Accessory)
- Front Control Panel and I/O Cable

## Appendix F: Statement of Volatility

The tables in this section are used to identify the volatile and non-volatile memory components for system boards used within the Intel® Server System R1000WT product family.

The tables provide the following data for each identified component.

### **Component Type**

Three types of memory components are used on the server board assembly. These include:

- **Non-volatile:** Non-volatile memory is persistent, and is not cleared when power is removed from the system. Non-Volatile memory must be erased to clear data. The exact method of clearing these areas varies by the specific component. Some areas are required for normal operation of the server, and clearing these areas may render the server board inoperable.
- **Volatile:** Volatile memory is cleared automatically when power is removed from the system.
- **Battery powered RAM:** Battery powered RAM is similar to volatile memory, but is powered by a battery on the server board. Data in Battery powered Ram is persistent until the battery is removed from the server board.

### **Size**

The size of each component includes sizes in bits, Kbits, bytes, kilobytes (KB) or megabytes (MB).

### **Board Location**

The physical location of each component is specified in the Board Location column. The board location information corresponds to information on the server board silkscreen.

### **User Data**

The flash components on the server boards do not store user data from the operating system. No operating system level data is retained in any listed components after AC power is removed. The persistence of information written to each component is determined by its type as described in the table.

Each component stores data specific to its function. Some components may contain passwords that provide access to that device's configuration or functionality. These passwords are specific to the device and are unique and unrelated to operating system passwords. The specific components that may contain password data are:

- **BIOS:** The server board BIOS provides the capability to prevent unauthorized users from configuring BIOS settings when a BIOS password is set. This password is stored in BIOS flash, and is only used to set BIOS configuration access restrictions.
- **BMC:** The server boards support an Intelligent Platform Management Interface (IPMI) 2.0 conformant baseboard management controller (BMC). The BMC provides health monitoring, alerting and remote power control capabilities for the Intel® server board. The BMC does not have access to operating system level data.

The BMC supports the capability for remote software to connect over the network and perform health monitoring and power control. This access can be configured to require authentication by a password. If configured, the BMC will maintain user passwords to control this access. These passwords are stored in the BMC flash.

## Intel® Server Board S2600WT (iPN - H21573-xxx and G92187-xxx)

Component Type	Size	Board Location	User Data	Name
Non-Volatile	128Mbit	U4F1	No(BIOS)	BIOS Flash
Non-Volatile	128Mbit	U2D2	No(FW)	BMC Flash
Non-Volatile	16Mbit	U5L2	No	10 GB NIC EEPROM (S2600WTTR)
Non-Volatile	256K bit	U5L3	No	1 GB NIC EEPROM (S2600WT2R)
Non-Volatile	N/A	U1E1	No	CPLD
Non-Volatile	N/A	U1C1	No	IPLD
Volatile	128 MB	U1D2	No	BMC SDRAM

## 1U 1 Slot PCIe\* Riser Card (iPN – H39531-xxx)

Component Type	Size	Board Location	User Data	Name
N/A	N/A	None	No	N/A

## Front Panel Board (iPN – H29366-xxx)

Component Type	Size	Board Location	User Data	Name
Non-Volatile	256x8	U1A1	Yes	PSOC / Microcontroller

## 1U 4 x 3.5" Hot Swap Back Plane option (iPN – G97162-xxx)

Component Type	Size	Board Location	User Data	Name
Non-Volatile	16384x8	EU7L1	Yes	PSOC / Microcontroller / FRU
Non-Volatile	1024x8	U1	No	SAS Re-Driver Settings

## 1U 8 x 2.5" SAS Hot Swap Back Plane option (iPN – G97152-xxx)

Component Type	Size	Board Location	User Data	Name
Non-Volatile	16384x8	U8A4	Yes	PSOC / Microcontroller / FRU
Non-Volatile	1024x8	U25	No	SAS Re-Driver Settings

**1U 8 x 2.5" Combo PCIe\* SFF (NVMe) / SAS Hot Swap Back Plane Accessory Kit (iPC - A1U44X25NVMEDK)**

**1U 8 x 2.5" Combo PCIe\* SFF (NVMe) / SAS Hot Swap Back Plane (iPN – G97154-xxx)**

Component Type	Size	Board Location	User Data	Name
Non-Volatile	16384x8	U8A4	Yes	PSOC / Microcontroller / FRU
Non-Volatile	1024x8	U25	No	SAS Re-Driver Settings

**PCIe\* SFF SSD Add-in Re-driver Card (iPN – G97168-xxx)**

Component Type	Size	Board Location	User Data	Name
Non-Volatile	1024x8	U24	No	PCIe Re-Timer Settings
Non-Volatile	256x8	U3	Yes	FRU

**Intel® Remote Management Module Lite Accessory Option (iPC – AXXRMM4LITE)**

Component Type	Size	Board Location	User Data	Name
Non-Volatile	1Mbit	U2B1	No	RMM Programming

**750W power supply module (iPC - FXX750PCRPS & AXX750DCCRPS)**

Component Type	Size	Location	User Data	Name	Description
Non-Volatile	64K	N/A	YES	750 power supply	IC MCU FLASH 64K*8+1K*8 TQFP-44P SMD / Manufacture Microchip



## Appendix G: Intel® Storage System R1000WT

The Intel® Storage System R1000WT product family has features, functions, and support specifications similar to those of the Intel® Server System R1000WT product family. This section identifies the features and functions that make them different.

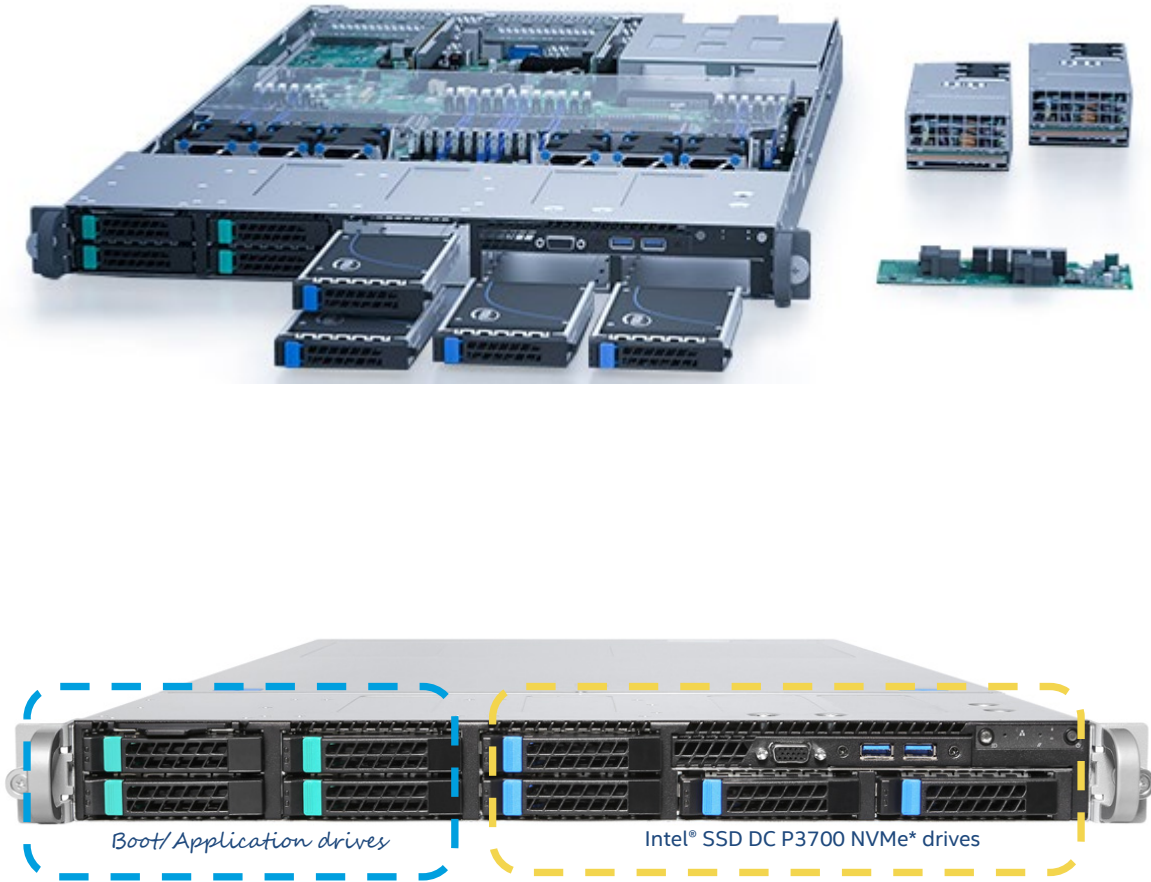

Figure 60. Intel® Storage Server R1000WT

## Intel® Server System R1000WT Family TPS

There are two Intel product codes that make up the product family:

### **R1208WTTA04NVMR & R1208WTTB04NVMR**

Systems within the Intel® Storage System R1000WT support the following features:

**Table 45. Intel® Storage System R1000WT Feature List**

Feature	Description
Chassis Type	1U Rack Mount Chassis
Server Board	<ul style="list-style-type: none"> <li>▪ Intel® Server Board S2600WT w/Dual 10GbE ports – (Intel product code - <b>S2600WTTR</b>)</li> </ul>
Processor Support	<ul style="list-style-type: none"> <li>▪ Two LGA2011-3 (Socket R3) processor sockets</li> <li>▪ Support for one or two Intel® Xeon® processors E5-2600 v3 and v4 product family</li> <li>▪ Maximum supported Thermal Design Power (TDP) of up to 145 W.</li> </ul>
Memory	<ul style="list-style-type: none"> <li>▪ 24 DIMM slots – 3 DIMMs/Channel – 4 memory channels per processor</li> <li>▪ Registered DDR4 (RDIMM), Load Reduced DDR4 (LRDIMM)</li> <li>▪ Memory data transfer rates:               <ul style="list-style-type: none"> <li>○ DDR4 RDIMM: 1600 MT/s (3DPC), 1866 MT/s (2DPC) and 2133 MT/s (1DPC)</li> <li>○ DDR4 LRDIMM: 1600 MT/s (3DPC), 2133 MT/s (2DPC &amp; 1DPC)</li> </ul> </li> <li>▪ DDR4 standard I/O voltage of 1.2V</li> </ul>
Chipset	Intel® C612 chipset
External I/O connections	<ul style="list-style-type: none"> <li>▪ DB-15 Video connectors               <ul style="list-style-type: none"> <li>○ Front and Back</li> </ul> </li> <li>▪ RJ-45 Serial Port A connector</li> <li>▪ Dual 10 GbE RJ-45 Network Interface connectors</li> <li>▪ Dedicated RJ-45 server management NIC</li> <li>▪ Three USB 2.0 / 3.0 connectors on back panel</li> <li>▪ Two USB 2.0 / 3.0 connectors on front panel</li> </ul>
Internal I/O connectors / headers	<ul style="list-style-type: none"> <li>▪ One Type-A USB 2.0 connector</li> <li>▪ One 2x5 pin connector providing front panel support for two USB 2.0 ports</li> <li>▪ One 2x10 pin connector providing front panel support for two USB 2.0 / 3.0 ports</li> <li>▪ One 2x15 pin SSI-EEB compliant front panel header</li> <li>▪ One 2x7pin Front Panel Video connector</li> <li>▪ One DH-10 Serial Port B connector</li> </ul>
Intel® I/O Module Accessory Options	<p>The server board includes a proprietary on-board connector allowing for the installation of a variety of available Intel® I/O modules. An installed I/O module can be supported in addition to standard on-board features and add-in PCIe cards.</p> <ul style="list-style-type: none"> <li>▪ AXX4P1GBPWL IOM – Quad port RJ45 1 GbE based on Intel® Ethernet Controller I350</li> <li>▪ AXX10GBTWLIOM3 – Dual port RJ-45 10GBase-T based on Intel® Ethernet Controller x540</li> <li>▪ AXX10GBNIAIOM – Dual port SFP+ 10 GbE module based on Intel® 82599 10 GbE controller</li> <li>▪ AXX1FDRIBIOM – Single port QSFP FDR 56 GT/S speed InfiniBand* module</li> <li>▪ AXX2FDRIBIOM – Dual port QSFP FDR 56 GT/S speed infiniband* module</li> <li>▪ AXX1P40FRTIOM – Single port QSFP+ 40 GbE module</li> <li>▪ <b>AXX2P40FRTIOM</b> – Dual port QSFP+ 40 GbE module</li> </ul>
System Fans	<ul style="list-style-type: none"> <li>▪ Six managed 40mm dual rotor system fans</li> <li>▪ One power supply fan for each installed power supply module</li> </ul>

## Intel® Server System R1000WT Family TPS

Feature	Description
Riser Card Support	<p>Support for two riser cards:</p> <ul style="list-style-type: none"> <li>▪ Riser #1 – PCIe* Gen3 x24 – 1 PCIe slot</li> <li>▪ Riser #2 – PCIe* Gen3 x24 – 1 PCIe slot</li> </ul> <p>With two riser cards installed, up to 2 possible add-in cards can be supported:</p> <ul style="list-style-type: none"> <li>▪ 2 Full Height / Half Length add-in cards via Risers #1 and #2</li> </ul> <p><b>NOTE:</b> Riser card #2 is pre-populated with PCIe* NVMe interface add-in card</p>
Video	<ul style="list-style-type: none"> <li>▪ Integrated 2D Video Controller</li> <li>▪ 16 MB DDR3 Memory</li> </ul>
On-board storage controllers and options	<ul style="list-style-type: none"> <li>▪ 10 x SATA 6Gbps ports (6Gb/s, 3 Gb/s and 1.5Gb/s transfer rates are supported) <ul style="list-style-type: none"> <li>○ Two single port SATA connectors capable of supporting up to 6 Gb/sec</li> <li>○ Two 4-port mini-SAS HD (SFF-8643) connectors capable of supporting up to 6 Gb/sec /SATA</li> </ul> </li> <li>▪ One eUSB 2x5 pin connector to support 2mm low-profile eUSB solid state devices</li> <li>▪ Optional SAS IOC/ROC support via on-board Intel® Integrated RAID module connector</li> <li>▪ Embedded Software SATA RAID <ul style="list-style-type: none"> <li>○ Intel® Rapid Storage RAID Technology (RSTe) 4.1</li> <li>○ Intel® Embedded Server RAID Technology 2 (ESRT2) 1.41 with optional RAID 5 key support</li> </ul> </li> </ul>
Security	Intel® Trusted Platform Module (TPM) – AXXTPE5, AXXTPE6, AXXTPE7 (Accessory Option)
Server Management	<ul style="list-style-type: none"> <li>▪ Integrated Baseboard Management Controller, IPMI 2.0 compliant</li> <li>▪ Support for Intel® Server Management Software</li> <li>▪ On-board RJ45 management port</li> <li>▪ Advanced Server Management via an Intel® Remote Management Module 4 Lite (Accessory Option)</li> </ul>
Power Supply	<ul style="list-style-type: none"> <li>▪ The server system can support 1 or 2 power supply modules, providing support for the following power configurations: 1+0 (Single PS), or 1+1 Redundant Power and 2+0 Combined Power (Dual PS)</li> <li>▪ (1) AC 750W Platinum (Included)</li> </ul>
Hot Swap Drive Bay <b>R1208WTTA04NVMR</b>	<p>(8) – 2.5" Hot-swap drive bays</p> <ul style="list-style-type: none"> <li>• Includes (1) Combo (NVMe/SAS) backplane</li> <li>• Includes (4) 2.5" hot swap drive trays (Green Tab) + drive blanks + SATA/SAS cable</li> <li>• Includes (4) 2.5" hot swap NVMe drive assemblies (Blue Tab) <ul style="list-style-type: none"> <li>○ Includes (4) 2TB Intel® SSD DC P3700 (SFF NVMe) Drives</li> <li>○ Includes (1) PCIe* SSD Interface Card (installed in Riser #2) + cables</li> </ul> </li> </ul>
Hot Swap Drive Bay <b>R1208WTTB04NVMR</b>	<p>(8) – 2.5" Hot-swap drive bays</p> <ul style="list-style-type: none"> <li>• Includes (1) Combo (NVMe/SAS) backplane</li> <li>• Includes (4) 2.5" hot swap drive trays (Green Tab) + drive blanks + SATA/SAS cable</li> <li>• Includes (4) 2.5" hot swap NVMe drive assemblies (Blue Tab) <ul style="list-style-type: none"> <li>○ Includes (4) 800GB Intel® SSD DC P3700 (SFF NVMe) Drives</li> <li>○ Includes (1) PCIe* SSD Interface Card (installed in Riser #2) + cables</li> </ul> </li> </ul>
Supported Rack Mount Kit Accessory Options	<ul style="list-style-type: none"> <li>▪ AXXPRAIL – Tool-less rack mount rail kit – 800mm max travel length</li> <li>▪ AXVELVRAIL – Enhanced value rack mount rail kit - 424mm max travel length</li> <li>▪ AXX1U2UCMA – Cable Management Arm – (*supported with AXXPRAIL only)</li> <li>▪ AXX2POSTBRCKT – 2-post fixed mount bracket kit</li> <li>▪ A1USHRTRAIL - 1U Premium quality rails with no CMA support</li> <li>▪ A1UFULLRAIL - 1U Premium quality rails with CMA support</li> </ul>

## Manageability Features

The Intel® Storage System R1000 includes management features that provide NVMe health monitoring and alerting. Added health sensors give system administrators notification of potential issues with installed NVMe drives.

- **NVMe Percentage of life monitoring** – Monitors overall wear of the NVMe drive. As this value nears 100%, administrators can prepare to back up data and replace drives as needed.
- **NVMe Temperature monitoring** – Provides the ability to read and report the case temperature of installed NVMe drives. NVMe drives may operate at higher temperatures as compared to traditional hard drives. With temperature monitoring, if desired, system administrators can modify preprogrammed fan speed control to operate system fans to more aggressive lower or higher operating levels.
- **Integrated BMC Web Console** – Provides administrators remote access to NVMe drive information



## Appendix H: Product Regulatory Information

This product has been evaluated and certified as Information Technology Equipment (ITE), which may be installed in offices, schools, computer rooms, and similar commercial type locations. The suitability of this product for other product certification categories and/or environments (such as: medical, industrial, telecommunications, NEBS, residential, alarm systems, test equipment, etc.), other than an ITE application, will require further evaluation and may require additional regulatory approvals.

Intel has verified that all L3, L6, and L9 server products<sup>2</sup> **as configured and sold by Intel** to its customers comply with the requirements for all regulatory certifications defined in the following table. It is the Intel customer's responsibility to ensure their final server system configurations are tested and certified to meet the regulatory requirements for the countries to which they plan to ship and or deploy server systems into.

Regulatory Certification	Intel® Server S2600WT Family		NOTES
	"Wildcat Pass"		Intel Project Code Name
	L3 Board	L6 / L9 System	Product Integration Level
	S2600WT	R1000WT	Intel® Server System R1000WT Family
RCM DoC Australia & New Zealand	✓	✓	
CB Certification & Report (International - report to include all CB country national deviations)	✓	✓	
China CCC Certification	○	○	
CU Certification (Russia/Belarus/Kazakhstan)	○	✓	
Europe CE Declaration of Conformity	✓	✓	
FCC Part 15 Emissions Verification (USA & Canada)	✓	✓	
Germany GS Certification	○	✓	
India BIS Certification	○	●	Only applicable to select OEM defined SKUs
International Compliance – CISPR32 & CISPR24	✓	✓	
Japan VCCI Certification	○	✓	
Korea KC Certification	✓	✓	
Mexico Certification	○	○	
NRTL Certification (USA & Canada)	✓	✓	
South Africa Certification	○	✓	
Taiwan BSMI Certification	✓ (DOC)	✓	
Ukraine Certification	○	✓	

### Table Key

Not Tested / Not Certified	○
Tested / Certified – Limited OEM SKUs only	●
Testing / Certification (Planned)	(Date)
Tested / Certified	✓

<sup>2</sup> An L9 system configuration is a power-on ready server system with NO operating system installed.

An L6 system configuration requires additional components to be installed in order to make it power-on ready. L3 are component building block options that require integration into a chassis to create a functional server system.

## EU Directive 2019/424 (Lot 9)

Beginning on March 1, 2020, an additional component of the European Union (EU) regulatory CE marking scheme, identified as EU Directive 2019/424 (Lot 9), will go into effect. After this date, all new server systems shipped into or deployed within the EU must meet the full CE marking requirements including those defined by the additional EU Lot 9 regulations.

Intel has verified that all L3, L6, and L9 server products<sup>3</sup> **as configured and sold by Intel** to its customers comply with the full CE regulatory requirements for the given product type, including those defined by EU Lot 9. It is the Intel customer's responsibility to ensure their final server system configurations are SPEC® SERT™ tested and meet the new CE regulatory requirements.

Visit the following website for additional EU Directive 2019/424 (Lot9) information:

<https://eur-lex.europa.eu/legal-content/EN/TXT/?uri=CELEX:32019R0424>

In compliance with the EU Directive 2019/424 (Lot 9) materials efficiency requirements, Intel makes available all necessary product collaterals as identified below:

- **Product Serviceability Instructions**
  - *Intel® Server System R1000WT Product Family System Integration and Service Guide*
  - *Intel® Server System R2000WT Product Family System Integration and Service Guide*
  - <https://www.intel.com/content/www/us/en/support/articles/000007225/server-products.html>
  - <https://www.intel.com/content/www/us/en/support/articles/000006751/server-products.html>
- **Product Specifications**
  - *Intel® Server Board S2600WT Product Family Technical Product Specification (This document)*
  - *Intel® Server System R1000WT Product Family Technical Product Specification*
  - *Intel® Server System R2000WT Product Family Technical Product Specification*
  - <https://www.intel.com/content/www/us/en/support/articles/000005856/server-products/server-boards.html>
- **System BIOS/Firmware and Security Updates – Intel® Server Board S2600WT family**
  - System Update Package (SUP) – uEFI only
  - Intel® One Boot Flash Update (OFU) – Various OS Support
  - <https://downloadcenter.intel.com/product/78562/Intel-Server-Board-S2600WT-Family>
- **Intel Solid State Drive (SSD) Secure Data Deletion and Firmware Updates**
  - Note: for system configurations that may be configured with an Intel SSD
  - Intel® Solid State Drive Toolbox
  - <https://downloadcenter.intel.com/download/29205?v=t>
- **Intel® RAID Controller Firmware Updates and other support collaterals**
  - Note: for system configurations that may be configured with an Intel® RAID Controller
  - <https://www.intel.com/content/www/us/en/support/products/43732/server-products/raid-products.html>

---

<sup>3</sup> An L9 system configuration is a power-on ready server system with NO operating system installed.

An L6 system configuration requires additional components to be installed in order to make it power-on ready. L3 are component building block options that require integration into a chassis to create a functional server system

## EU Lot9 Support Summary – R1000 – Intel® Server System R1000WT Family (Wildcat Pass)

**DISCLAIMER** – The information contained within the following tables is for reference purposes only and is intended to provide Intel customers with a template to report product information necessary for (EU) 2019/424 (Lot 9) server conformity assessment. The information provided herein does not represent any final shipping server system test results, and customer's actual test results for shipping server configurations may differ from the information provided. Use of this information is at the sole risk of the user, and Intel assumes no responsibility for customers server system level regulation compliance to EU 2019/424 (Lot 9).

Product Info.					
Product Type	Server				
Manufacturer Name	Intel Corporation				
Registered trade name and address	Intel 2200 Mission College Blvd, Santa Clara, CA 95054-1594, USA				
Product model number and model numbers for low end performance and high-end performance configure if applicable	R1000				
Product Launch Date	2014				
Test System Manufacture Date	2016				
Power Supply option efficiency at 10%, 20%, 50% and 100% of rated output power	AXX1100PCRPS (S-1100ADU00-201) – 1100W AC – 80+ Platinum				
	<b>Model</b>	<b>100%</b>	<b>50%</b>	<b>20%</b>	<b>10%</b>
	S-1100ADU00-201	91%	94%	90%	82%
PSU factor at 50% of rated load level	AXX1100PCRPS: >0.94				
PSU Rated Power Output (Server Only)	AXX1100PCRPS: 1100 Watts				
Idle state power (Server only) (Watts)	Refer to the following table				
List of all components for additional idle power allowances (server only)	Refer to the following table				
Maximum power (Server only)	Refer to the following table				
Declared operating condition class  Note: Refer to Appendix D: System Configuration Table for Thermal Compatibility to determine supported ASHRAE levels by configuration	<ul style="list-style-type: none"> <li>ASHRAE Class A2-Continuous Operation 10 °C to 35 °C with the maximum rate of change not to exceed 10 °C per hour</li> <li>ASHRAE Class A3 – Includes operation up to 40°C for up to 900 hours per year</li> <li>ASHRAE Class A4 - Includes operation up to 45°C for up to 90 hours per year</li> </ul>				
Idle State Power (watts) at the higher boundary temp (Server Only)	Refer to the following table				
the active state efficiency and the performance in active state of the server (server only)	Refer to the following table				
Information on the secure data deletion functionality	Refer to the following table				
for blade server, a list of recommended combinations with compatible chassis (Server only)	Not Applicable				
If Product Model Is Part Of A Server Product Family, a list of all model configurations that are represented by the model shall be supplied (Server only)	Not Applicable				

## Energy Efficiency Data of R1000 – 1 (Single) CPU Installed Configuration

System Configurations				
			1 CPU Low-end Config.	1 CPU High-end Config.
Details	Chassis	Model	Intel® Server System R1208WTTYSR	Intel® Server System R1208WTTYSR
	Motherboard (MB)	# of MBs installed in system	1	1
		Model	Intel® Server Board S2600WT	Intel® Server Board S2600WT
	CPU	# of CPUs installed per Node or MB	1	1
		Model	Intel® Xeon® processor E5-2690 v4	Intel® Xeon® processor E5-2699 v4
	Memory	# of DIMMs installed per Node or MB	4 (1 DIMM / Mem. Channel)	4 1 DIMM / Mem, Channel
		Capacity per DIMM (GB)	8 GB	64 GB
		Total Memory (GB) per MB	32 GB	256 GB
	SSD	# of SSDs installed per MB	2	2
	Power Supply (PSU)	# of PSU installed	1	1
		Model	AXX1100PCRPS – 1100W (S-1100ADU00-201)	AXX1100PCRPS – 1100W (S-1100ADU00-201)
System Software Revisions installed to MB			BIOS –SE5C610.86B.01.01.0028 BMC – 01.56.11315 FRU/SDR – 1.18	
Data Summary				
Measured and Calculated Server Allowance	P Base		25	25
	Additional CPU		41.12	54.97
	Additional Power Supply		0	0
	Storage Devices		10	10
	Additional Memory		5.04	45.36
	Additional I/O Device (10Gx 15W/2Port on MB)		2	2
	Perf <sub>cpu</sub>		4.11	5.50
Limits/ Results	Idle power allowances (W)		83.16	137.33
	Idle power tested (W) Per node		66.90	72.40
	Minimum Eff <sub>ACTIVE</sub>		9	9
	Eff <sub>ACTIVE</sub> tested		20.51	26.30
Other test result	Idle Power at Higher Temp. (per Node) @ 35 degree C		99.1	81.2
	Max Power (Per Node)		237.00	286.30



## Energy Efficiency Data of R1000 – 2 (Dual) CPUs Installed Configuration

System Configurations				
			2 CPU Low-end Config.	2 CPU High-end Config.
Details	Chassis	Model	Intel® Server System R1208WTTYSR	Intel® Server System R1208WTTYSR
	Motherboard (MB)	# of MBs installed in system	1	1
		Model	Intel® Server Board S2600WT	Intel® Server Board S2600WT
	CPU	# of CPUs installed per MB	2	2
		Model	Intel® Xeon® processor E5-2680 v3	Intel® Xeon® processor E5-2699 v4
	Memory	# of DIMMs installed per MB	8 (1 DIMM / Mem. Channel)	8 (1 DIMM / Mem. Channel)
		Capacity per DIMM (GB)	8 GB	64 GB
		Total Memory (GB) per Node or MB	64 GB	512 GB
	SSD	# of SSDs installed per Node or MB	2	2
	Power Supply (PSU)	# of PSU installed	2	2
Model		AXX1100PCRPS – 1100W (S-1100ADU00-201)	AXX1100PCRPS – 1100W (S-1100ADU00-201)	
System Software Revisions installed to MB			BIOS –SE5C610.86B.01.01.0028 BMC – 01.56.11315 FRU/SDR – 1.18	
Data Summary				
Measured and Calculated Server Allowance	P Base		38	38
	Additional CPU		45.18	74.71
	Additional Power Supply		10	10
	Storage Devices		10	10
	Additional Memory		10.8	91.44
	Additional I/O Device (10Gx 15W/2Port on MB)		2	2
	Perf <sub>cpu</sub>		6.45	10.67
Limits/ Results	Idle power allowances (W)		115.98	226.15
	Idle power tested (W) Per node		88.90	100.80
	Minimum Eff <sub>ACTIVE</sub>		9.5	9.5
	Eff <sub>ACTIVE</sub> tested		20.23	28.91
Other test result	Idle Power at Higher Temp. (per Node) @ 35 degree C		99.1	81.2
	Max Power (Per Node)		457.80	526.80

## Other Information:

## Chemical Declaration

- Neodymium Not Applicable. (No HDD offered)
- Cobalt Not Applicable. (No BBUs. Coin battery is out of scope)

## Glossary

Word/Acronym	Definition
BMC	Baseboard Management Controller
BIOS	Basic Input/Output System
CLST	Closed Loop System Throttling
CMOS	Complementary Metal-oxide-semiconductor
CPU	Central Processing Unit
DDR4	Double Data Rate 4 <sup>th</sup> edition
DIMM	Dual In-line Memory Module
DOM	Disk-on-module
DPC	DIMMs per Channel
EDS	External Design Specification
EPS	External Product Specification
FP	Front Panel
FRB	Fault Resilient Boot
FRU	Field Replaceable Unit
GPGPU	General Purpose Graphic Processing Unit
HDD	Hard Disk Drive
I2C	Inter-integrated Circuit bus
LCD	Liquid Crystal Display
LCP	Local Control Panel
LED	Light Emitting Diode
LFM	Linear Feet per Minute – Air Flow measurement
LPC	Low-pin Count
LRDIMM	Load Reduced DIMM
LSB	Least Significant Bit
MSB	Most Significant Bit
MTBF	Mean Time Between Failure
NIC	Network Interface Card
NMI	Non-maskable Interrupt
OCP	Over-current Protection
OTP	Over-temperature Protection
OVP	Over-voltage Protection
PCI	Peripheral Component Interconnect
PCB	Printed Circuit Board
PCIe*	Peripheral Component Interconnect Express*
PCI-X	Peripheral Component Interconnect Extended
PFC	Power Factor Correction
POST	Power-on Self Test
PSU	Power Supply Unit
RAID	Redundant Array of Independent Disks
RAM	Random Access Memory
SSD	Solid State Drive
TDP	Thermal Design Power

## Intel® Server System R1000WT Family TPS

Word/Acronym	Definition
TPM	Trusted Platform Module
TPS	Technical Product Specification
USB	Universal Serial Bus
VLSI	Very Large Scale Integration
VSB	Voltage Standby

## Reference Documents

See the following documents for additional information:

- Intel® Server Board S2600WT Technical Product Specification
- Intel® Server S2600WT Product Configuration Guide and Spares/Accessories List
- Intel® Server System R1000WT Product Family System Integration and Service Guide
- Intel® S2600WT Product Family Power Budget and Thermal Configuration Tool
- *Advanced Configuration and Power Interface Specification*, Revision 3.0, <http://www.acpi.info/>.
- *Intelligent Platform Management Bus Communications Protocol Specification*, Version 1.0. 1998. Intel Corporation, Hewlett-Packard Company, NEC Corporation, Dell Computer Corporation.
- *Intelligent Platform Management Interface Specification*, Version 2.0. 2004. Intel Corporation, Hewlett-Packard Company, NEC Corporation, Dell Computer Corporation.
- Platform Support for Serial-over-LAN (SOL), TMode, and Terminal Mode External Architecture Specification, Version 1.1, 02/01/02, Intel Corporation.
- Intel® Remote Management Module User's Guide, Intel Corporation.
- Alert Standard Format (ASF) Specification, Version 2.0, 23 April 2003, ©2000-2003, Distributed Management Task Force, Inc., <http://www.dmtf.org>.
- Intel® Server System BIOS External Product Specification for Intel® Servers Systems supporting the Intel® Xeon® processor E5-2600 V3 and v4 product family – (Intel NDA Required)
- Intel® Server System BIOS Setup Utility Guide for Intel® Servers Systems supporting the Intel® Xeon® processor E5-2600 V3 and v4 product family
- Intel® Server System BMC Firmware External Product Specification for Intel® Servers Systems supporting the Intel® Xeon® processor E5-2600 V3 and v4 product family – (Intel NDA Required)
- SmArT & CLST Architecture on Intel Systems and Power Supplies Specification (Doc Reference # 461024)
- Intel Integrated RAID Module RMS25PB080, RMS25PB040, RMS25CB080, and RMS25CB040 Hardware Users Guide
- Intel® Remote Management Module 4 Technical Product Specification
- Intel® Remote Management Module 4 and Integrated BMC Web Console Users Guide
- Intel® Ethernet Controller I350 Family Product Brief
- Intel® Ethernet Controller X540 Family Product Brief
- Intel® Chipset C610 product family (“Wellsburg”) External Design Specification – (Intel NDA Required)
- Intel® Xeon® Processor E5-4600/2600/2400/1600 v3 and v4 Product Families (“Haswell”) and (“Broadwell”) External Design Specification – (Intel NDA Required)

