



# Intel® Server System M50FCP2UR

## *Technical Product Specification*

An overview of product features, functions, architecture, and support specifications.

Rev. 1.5

June 2024



# M50FCP2UR

Delivering Breakthrough Data Center System Innovation – Experience What's Inside!

<This page intentionally left blank>

## Document Revision History

Date	Revision	Changes
January 2023	1.0	Production Release
February 2023	1.1	Adding Intel® VROC information Remove Intel® Optane™ PMem 300 Series support Updating Table 45. Supported Video Resolutions Minor updates for clarity
May 2023	1.2	Update Table 3. System Environmental Limits Summary Added Appendix B. Software License Key Order, Registration, and Installation Minor updates for clarity
September 2023	1.3	Edits made to Figure 17. System Configuration and Recovery Jumpers Update Appendix B. Software License Key Management Minor updates for clarity
February 2024	1.4	Add 5 <sup>th</sup> Gen Intel® Xeon® Scalable Processor Family support Add Titanium PSU AXX2100TCRPS in EU Lot9 Support Summary Update section 4.7 Air Duct Support Options
June 2024	1.5	Update Appendix D. System Configuration Table for Thermal Compatibility Edits made to Figure 13. Intel® Server Board M50FCP2SBSTD Architectural Block Diagram Minor updates for clarity

## ***Disclaimers***

Intel technologies' features and benefits depend on system configuration and may require enabled hardware, software, or service activation. Performance varies depending on system configuration. No computer system can be absolutely secure. Check with your system manufacturer or retailer or learn more at [intel.com](http://intel.com).

You may not use or facilitate the use of this document in connection with any infringement or other legal analysis concerning Intel products described herein. You agree to grant Intel a non-exclusive, royalty-free license to any patent claim thereafter drafted which includes subject matter disclosed herein.

No license (express or implied, by estoppel or otherwise) to any intellectual property rights is granted by this document.

The products described may contain design defects or errors known as errata, which may cause the product to deviate from published specifications. Current characterized errata are available on request.

Intel disclaims all express and implied warranties, including without limitation, the implied warranties of merchantability, fitness for a particular purpose, and non-infringement, as well as any warranty arising from course of performance, course of dealing, or usage in trade.

Copies of documents that have an order number and are referenced in this document may be obtained by calling 1-800-548-4725 or by visiting [www.intel.com/design/literature.htm](http://www.intel.com/design/literature.htm).

Intel, Xeon, Intel Optane, and the Intel logo are trademarks of Intel Corporation or its subsidiaries in the U.S. and/or other countries.

\*Other names and brands may be claimed as the property of others.

© Intel Corporation

# Table of Contents

<b>1. Introduction</b>	<b>14</b>
1.1 Reference Documents	15
<b>2. Server System Family Overview</b>	<b>17</b>
2.1 Server System Feature Set	19
2.2 System Feature Identification	22
2.3 Front Drive Bay Options	23
2.4 Server Board Features	26
2.5 System Dimensional and Labeling Options	29
2.6 System Top Cover	31
2.7 System Cable Routing Channels	33
2.8 Rack and Cabinet Mounting Kit	34
2.9 System Level Environmental Limits	36
2.10 System Packaging	37
<b>3. System Power</b>	<b>38</b>
3.1 Power Supply Configurations	39
3.1.1 Single Power Supply (1+0) Power Configuration	39
3.1.2 Dual Power Supply 1+1 Power Configuration	39
3.1.3 Dual Power Supply 2+0 Power Configuration	40
3.2 Intel® Power Calculator Tool	40
3.3 Closed Loop System Throttling (CLST)	40
3.4 Smart Ride Through (SmaRT) Throttling	41
3.5 Power Supply Cold Redundancy	41
3.6 Power Supply Specification Overview	41
3.6.1 Power Supply Module Efficiency	41
3.6.2 AC Power Cord Specifications	42
3.7 AC Power Supply Features	43
3.7.1 Power Supply Status LED	43
3.7.2 Protection Circuits	43
<b>4. Thermal Management</b>	<b>45</b>
4.1 Thermal Operation and Configuration Requirements	46
4.2 Thermal Management Overview	47
4.3 System Fans	48
4.4 Power Supply Module Fans	49
4.5 Fan Speed Control	49
4.6 Processor Heat Sink Options	49
4.7 Air Duct Support Options	50
<b>5. PCI Express* (PCIe*) Subsystem Overview</b>	<b>52</b>
5.1 PCIe Riser Slots	53
5.1.1 Determining where to install a PCIe add-in card	55
5.2 PCIe* Riser Card Options	56

5.2.1	3-Slot PCIe* Riser Card for Riser Slot #1 (iPC FCP2URISER1STD) .....	56
5.2.2	2-Slot PCIe* Riser Card for Riser Slot #1 (iPC FCP2URISER1DW) .....	57
5.2.3	2-Slot PCIe* Riser Card for Riser Slot #1 (iPC FCP2URISER1SW).....	57
5.2.4	PCIe* NVMe* Riser Card for Riser Slot #1 (iPC FCP2URISER1RTM).....	58
5.2.5	3-Slot PCIe* Riser Card for Riser Slot #2 (iPC FCP2URISER2STD).....	58
5.2.6	2-Slot PCIe* Riser Card for Riser Slot #2 (iPC FCP2URISER2DW).....	59
5.2.7	2-Slot PCIe* Riser Card for Riser Slot #2 (iPC FCP2URISER2SW).....	59
5.2.8	2-Slot PCIe* Riser Card for Riser Slot #3 (iPC FCP2URISER3STD).....	60
5.2.9	PCIe NVMe Riser Card for Riser Slot #3 (iPC CYPRISER3RTM).....	60
5.2.10	Auxiliary 12-Volt Power.....	61
5.3	Intel® Ethernet Network Adapter for OCP* Support.....	62
<b>6.</b>	<b>System Storage .....</b>	<b>64</b>
6.1	Front Drive Bay Overview .....	64
6.1.1	2.5" Front Drive Overview.....	64
6.1.2	3.5" Front Drive Overview.....	67
6.2	Hot-Swap Backplane (HSBP) Overview.....	70
6.2.1	SGPIO Functionality .....	70
6.2.2	I <sup>2</sup> C Functionality.....	70
6.2.3	HSBP Power.....	71
6.2.4	8 X 2.5" Backplane (iPC CYPHSBP2208).....	71
6.2.5	12 X 3.5" Backplane (iPC CYPHSBP2312) .....	74
6.3	NVMe* Storage Support.....	77
6.3.1	NVMe Support from the Server Board.....	77
6.3.2	PCIe* NVMe* Riser Card Options.....	77
6.3.3	Intel® Volume Management Device (Intel® VMD) 3.0 for NVMe* .....	78
6.3.4	Intel® Virtual RAID on CPU for NVMe (Intel® VROC for NVMe) 8.0 .....	80
6.3.5	NVMe* Drive Population Rules for Intel® VROC 8.0.....	81
6.4	Onboard SATA Support .....	85
6.4.1	Staggered Disk Spin-Up.....	86
6.4.2	Intel® Virtual RAID on CPU for SATA (Intel® VROC for SATA).....	86
6.5	SAS Storage Support.....	87
6.6	M.2 SSD Storage Support.....	87
6.7	Internal Fixed Mount Solid State Drive (SSD) Support.....	88
<b>7.</b>	<b>Front Control Panel and I/O.....</b>	<b>90</b>
7.1	Control Panel Features .....	90
7.2	Front I/O Features.....	92
7.3	Rear I/O Features.....	93
7.3.1	Remote Management Port .....	93
7.3.2	Serial Port A Support.....	93
7.3.3	USB Support.....	94
7.3.4	Video Support .....	94
<b>8.</b>	<b>Intel® Light-Guided Diagnostics .....</b>	<b>96</b>

8.1	Post Code Diagnostic LEDs .....	96
8.2	System ID LED .....	96
8.3	System Status LED.....	97
8.3.1	BMC Boot/Reset Status LED Indicators .....	97
8.4	Processor Fault LEDs.....	97
8.5	Memory Fault LEDs .....	98
8.6	Fan Fault LEDs.....	99
8.6.1	Power Supply Status LED .....	99
8.6.2	Drive Bay LED.....	99
<b>Appendix A.</b>	<b>Getting Help .....</b>	<b>100</b>
<b>Appendix B.</b>	<b>Software License Key Management.....</b>	<b>101</b>
B.1	Ordering Software License Key .....	101
B.2	Order and Register a License Key as an Add-on Accessory (Not via CTO) .....	101
B.3	Software License Key Installation .....	104
B.3.1	Installation Using the Integrated BMC Web Console.....	104
B.3.2	Installation Using the Intel® Server Configuration Utility .....	105
B.3.3	Installation Using Redfish*.....	106
<b>Appendix C.</b>	<b>Integration and Usage Tips.....</b>	<b>108</b>
<b>Appendix D.</b>	<b>System Configuration Table for Thermal Compatibility.....</b>	<b>109</b>
C.1	Normal Operating Mode with Dual Processors Installed .....	112
C.2	Normal Operating Mode with Single Processor Installed.....	163
<b>Appendix E.</b>	<b>System Sensors .....</b>	<b>212</b>
<b>Appendix F.</b>	<b>Statement of Volatility.....</b>	<b>214</b>
<b>Appendix G.</b>	<b>Product Regulatory Compliance.....</b>	<b>216</b>
<b>Appendix H.</b>	<b>Glossary .....</b>	<b>221</b>

## List of Figures

Figure 1. Intel® Server System M50FCP2UR Family .....	14
Figure 2. Intel® Server M50FCP2UR System Views (Top, Side, and Back).....	17
Figure 3. Intel® Server M50FCP2UR System Views (Front Drive Bay Configurations).....	18
Figure 4. Server System Components Overview.....	22
Figure 5. Back Panel Feature Identification.....	22
Figure 6. Air Duct Accessory Options .....	23
Figure 7. System with Optional Front Bezel – iPC CYP2UBEZEL .....	23
Figure 8. 8 x 2.5" Front Drive Bay Configuration – M50FCP2UR208 .....	24
Figure 9. 16 x 2.5" Front Drive Bay Configuration (M50FCP2UR208 with optional accessories).....	24
Figure 10. 24 x 2.5" Front Drive Bay Configuration (M50FCP2UR208 with optional accessories) .....	24
Figure 11. 12 x 3.5" Front Drive Bay Configuration – M50FCP2UR312.....	24
Figure 12. Front Panel Feature Identification.....	25
Figure 13. Intel® Server Board M50FCP2SBSTD Architectural Block Diagram .....	26
Figure 14. Intel® Server Board M50FCP2SBSTD Component / Feature Identification .....	27
Figure 15. Intel® Light-Guided Diagnostics – LED Identification .....	28
Figure 16. Intel® Light-Guided Diagnostics – Memory Fault LEDs.....	28
Figure 17. System Configuration and Recovery Jumpers.....	29
Figure 18. System Dimensions with 2100 Watt Power Supply Option.....	29
Figure 19. System Dimensions with 1300 Watt or 1600 Watt Power Supply Options.....	30
Figure 20. Label Emboss Dimensions.....	30
Figure 21. Pull-Out Tab Location .....	31
Figure 22. Pull-Out Tab Label Emboss Dimensions.....	31
Figure 23. Top System Cover Panels Shipping Screws.....	31
Figure 24. System Top Cover Removal.....	32
Figure 25. System Top Cover Installation.....	32
Figure 26. System Cable Routing Channels .....	33
Figure 27. Rear Panel Shipping Screw Holes.....	35
Figure 28. Power Supply Module Identification.....	38
Figure 29. 2100 W Power Supply Module Partially Out of Chassis.....	38
Figure 30. Power Supply Modules .....	39
Figure 31. AC Power Cable Connector .....	42
Figure 32. AC Power Cord Specification.....	42
Figure 33. System Airflow and Fan Identification.....	45
Figure 34. System Memory Modules / DIMM Blanks Configuration .....	47
Figure 35. System Fan Assembly.....	48
Figure 36. Supported Processor Heat Sinks.....	49
Figure 37. Standard Air Duct for 2U Height Processor Heat Sinks.....	50
Figure 38. Optional Air Duct for 1U Height Processor Heat Sinks.....	50
Figure 39. Optional GPGPU Air Duct for 1U Height Processor Heat Sink and GPGPU Add-In Cards.....	51
Figure 40. PCIe Subsystem Architecture.....	52



Figure 41. Riser Card Slots .....	53
Figure 42. Server System Back Panel Add-In Card Areas .....	54
Figure 43. Server System PCIe* Riser Add-In Card Areas .....	54
Figure 44. Riser Card Assembly Components.....	54
Figure 45. Riser Card Assembly Installation .....	55
Figure 46. 3-Slot PCIe* Riser Card for Riser Slot #1 .....	56
Figure 47. Two-Slot PCIe* Riser Card for Riser Slot #1 .....	57
Figure 48. Two-Slot PCIe* Riser Card for Riser Slot #1 .....	58
Figure 49. PCIe* NVMe* Riser Card for Riser Slot #1.....	58
Figure 50. Three-slot PCIe* Riser Card for Riser Slot #2 .....	59
Figure 51. Two-slot PCIe* Riser Card for Riser Slot #2 .....	59
Figure 52. Two-slot PCIe* Riser Card for Riser Slot #2 .....	60
Figure 53. Two-slot PCIe* Riser Card for Riser Slot #3 .....	60
Figure 54. PCIe NVMe Riser Card for Riser Slot#3 .....	61
Figure 55. Auxiliary 12-Volt Power Connectors.....	61
Figure 56. Intel® Ethernet Network Adapter for OCP* Placement.....	62
Figure 57. OCP* Adapter Bay Filler Removal.....	62
Figure 58. OCP* Adapter with Pull Tab Installation.....	63
Figure 59. 2.5" Drive Bay Components .....	65
Figure 60. 7-mm Drive Insertion into 2.5" Drive Bay.....	65
Figure 61. 7-mm Drive Removal from 2.5" Drive Bay .....	66
Figure 62. 2.5" Front Drive LED Identification.....	66
Figure 63. 3.5" Drive Bay Components .....	67
Figure 64. 3.5" Drive Insertion / Extraction .....	67
Figure 65. 3.5" Drive Assembly .....	68
Figure 66. 2.5" SSD Assembly into Drive Rail – Alignment and SSD Installation.....	69
Figure 67. 3.5" Front Drive LED Identification.....	69
Figure 68. Server Board HSBP Power Connector .....	71
Figure 69. 2.5" Backplane Placement .....	71
Figure 70. 8 x 2.5" Front Bay Drive Configuration – M50FCP2UR208 .....	72
Figure 71. 16 x 2.5" Front Bay Drive Configuration – M50FCP2UR208 with accessory options .....	72
Figure 72. 24 x 2.5" Front Bay Drive Configuration – M50FCP2UR208 with accessory options .....	72
Figure 73. 8 x 2.5" SAS/SATA/NVMe* Hot-Swap Backplane – Front Side.....	73
Figure 74. 8 x 2.5" SAS/SATA/NVMe* Hot-Swap Backplane – Back Side.....	73
Figure 75. Connecting Two x8 Backplanes.....	74
Figure 76. 3.5" Backplane Placement .....	74
Figure 77. 12 x 3.5" Front Bay Drive Configuration – M50FCP2UR312.....	75
Figure 78. 12 x 3.5" HSBP Connector Identification – Front Side.....	75
Figure 79. 12 x 3.5" HSBP Connector Identification – Back Side .....	76
Figure 80. PCIe* MCIO Connectors .....	77
Figure 81. PCIe* NVMe* Riser Card for Riser Slot #3.....	77
Figure 82. PCIe* NVMe* Riser Card for Riser Slot #1.....	78

Figure 83. NVMe* Storage Bus Event / Error Handling.....	78
Figure 84. Supported NVMe* Configurations – Windows* and Linux* .....	80
Figure 85. Backplane Cabling from Two Backplane Sources .....	82
Figure 86. Supported Drive Population for Server Board MCIO Connectors or Tri-Mode Intel® RAID Module	83
Figure 87. 12 x 3.5" HSBP NVMe* Connector Identification – Front Side.....	84
Figure 88. 12 x 3.5" HSBP Connector Identification – Back Side .....	84
Figure 89. Onboard SATA Cable Connectors and M.2 SSD Connectors.....	85
Figure 90. 2.5" Solid State Drive (SSD) Mounting Option.....	88
Figure 91. Peripheral Power Connector Identification .....	88
Figure 92. Onboard SATA Port Connectors .....	89
Figure 93. Front Control Panel Features .....	90
Figure 94. Front I/O Features .....	92
Figure 95. Rear I/O Features .....	93
Figure 96. Remote Management Port.....	93
Figure 97. Serial Port A.....	94
Figure 98. RJ45 Serial Port A Connector Pin Orientation .....	94
Figure 99. External USB 2.0 and 3.0 Connector Ports .....	94
Figure 100. Exploded View of POST Code Diagnostic, System ID, and System Status LEDs .....	96
Figure 101. System ID LED / Button.....	96
Figure 102. Processor Fault LEDs.....	98
Figure 103. Memory Fault LED Location .....	98
Figure 104. Fan Fault LED Location.....	99
Figure 105. Example Email.....	101
Figure 106. Register Key.....	102
Figure 107. Activate Key for Advanced System Management (ASM) Key .....	102
Figure 108. Activate Key for Intel® Virtual RAID on CPU Standard/Premium Software Key .....	103
Figure 109. Integrated BMC Web Console Advanced System Management Key Page.....	104
Figure 110. BMC Web Console System Information Page.....	105
Figure 111. Upload VROC Standard License Key Using SYSCFG Utility.....	106
Figure 112. Confirm Activation of VROC Standard License Key Using SYSCFG Utility .....	106
Figure 113. Redfish Command to Upload the VROC Premium Software License Key .....	107
Figure 114. Redfish Command to verify the activation status of the VROC Software License Key.....	107
Figure 115. PCIe SIG Add-in cards thermal level.....	111
Figure 116. Server Board Sensor Map.....	212
Figure 117. Server System Sensor Map.....	213

## List of Tables

Table 1. Intel® Server M50FCP Family Reference Documents and Support Collaterals.....	15
Table 2. Intel® Server System M50FCP2UR Features .....	19
Table 3. System Environmental Limits Summary.....	36
Table 4. 1300 W and 1600 W AC Power Supply Option Efficiency (80 PLUS* Titanium).....	42
Table 5. 2100 W AC Power Supply Option Efficiency (80 PLUS* Platinum) .....	42
Table 6. AC Power Cord Specifications.....	42
Table 7. LED Indicators.....	43
Table 8. Over Current Protection for 1300 W Power Supplies.....	43
Table 9. Over Current Protection for 1600 W Power Supplies.....	43
Table 10. Over Current Protection for 2100 W Power Supplies.....	43
Table 11. Over Voltage Protection (OVP) Limits for 1300 W, 1600 W, and 2100 W Power Supplies .....	44
Table 12. System Volumetric Airflow – M50FCP2UR208 .....	46
Table 13. System Volumetric Airflow – 16 x 2.5" Front Drive Bay Configuration .....	46
Table 14. System Volumetric Airflow – 24 x 2.5" Front Drive Bay Configuration .....	46
Table 15. System Volumetric Airflow – M50FCP2UR312 .....	46
Table 16. Processor / Chipset PCIe* Port Routing .....	53
Table 17. PCIe* Add-In Card Airflow (LFM) Support Limits – M50FCP2UR208 based x8, x16, x24 Front Drive Bay Systems, M50FCP2UR312 Fan Normal .....	55
Table 18. PCIe* Add-In Card Airflow (LFM) Support Limits – M50FCP2UR312 Fan Failure .....	55
Table 19. PCIe* Add-In Card Airflow (LFM) Support Limits – M50FCP2UR208 based x8, x16, x24 Front Drive Bay Systems Fan Failure .....	56
Table 20. PCIe* Riser Card Connector Description.....	57
Table 21. Two-slot PCIe* Riser Card Connector Description.....	57
Table 22. Two-slot PCIe* Riser Card Connector Description.....	58
Table 23. PCIe* NVMe* Riser Card Connector Description.....	58
Table 24. Three-Slot PCIe* Riser Card Connector Description.....	59
Table 25. Two-Slot PCIe* Riser Card Connector Description.....	59
Table 26. Two-slot PCIe* Riser Card Connector Description.....	60
Table 27. Two-slot PCIe* Riser Card Connector Description.....	60
Table 28. Auxiliary Power Connector Pinout ("OPT_12V_PWR") .....	62
Table 29. 2.5" Front Drive Amber Status LED States .....	66
Table 30. 2.5" Front Drive Green Activity LED States .....	66
Table 31. 3.5" Front Drive Amber Status LED States .....	69
Table 32. 3.5" Front Drive Green Activity LED States .....	69
Table 33. I <sup>2</sup> C Cable Connector Pinout.....	70
Table 34. Power Connector Pinout.....	71
Table 35. PCIe* NVMe* Riser Card Connector Description.....	77
Table 36. PCIe* NVMe* Riser Card Connector Description.....	78
Table 37. CPU PCIe Port Mapping for NVMe Connectivity – MCIO Connector & Riser Card Options .....	79
Table 38. CPU to PCIe* MCIO Connector Routing.....	80

Table 39. Intel® VROC for NVMe Activation License Key – Supported NVMe* RAID Features .....	81
Table 40. SATA_0 and SATA_1 Controller Feature Support .....	85
Table 41. Peripheral Power Connector Pinout Definition.....	89
Table 42. Power / Sleep LED Functional States .....	90
Table 43. System Status LED State Definitions.....	91
Table 44. RJ45 Serial Port A Connector Pinout .....	94
Table 45. Supported Video Resolutions .....	94
Table 46. BMC Boot / Reset Status LED State Definition .....	97
Table 47. Processor Fault LED State Definition .....	98
Table 48. Memory Fault LED State Definition.....	98
Table 49. Fan Fault LED State Definition .....	99
Table 50. Thermal testing results interpretation for air-cooled systems .....	112
Table 51. Thermal Configuration Matrix with Dual 4 <sup>th</sup> Gen Processors Installed – Normal Operating Mode (Table 1 of 4) (M50FCP2UR208 x24 Drive with 2U Heat Sink).....	112
Table 52. Thermal Configuration Matrix with Dual 4 <sup>th</sup> Gen Processors Installed – Normal Operating Mode (Table 2 of 4) (M50FCP2UR208 x24 Drive with 1U Heat Sink).....	116
Table 53. Thermal Configuration Matrix with Dual 5 <sup>th</sup> Gen Processors Installed – Normal Operating Mode (Table 3 of 4) (M50FCP2UR208 x24 Drive with 2U Heat Sink).....	119
Table 54. Thermal Configuration Matrix with Dual 5 <sup>th</sup> Gen Processors Installed – Normal Operating Mode (Table 4 of 4) (M50FCP2UR208 x24 Drive with 1U Heat Sink).....	122
Table 55. Thermal Configuration Matrix with Dual 4 <sup>th</sup> Gen Processors Installed – Normal Operating Mode (Table 1 of 4) (M50FCP2UR x16 Drive with 2U Heat Sink).....	125
Table 56. Thermal Configuration Matrix with Dual 4 <sup>th</sup> Gen Processors Installed – Normal Operating Mode (Table 2 of 4) (M50FCP2UR x16 Drive with 1U Heat Sink).....	129
Table 57. Thermal Configuration Matrix with Dual 5 <sup>th</sup> Gen Processors Installed – Normal Operating Mode (Table 3 of 4) (M50FCP2UR x16 Drive with 2U Heat Sink).....	132
Table 58. Thermal Configuration Matrix with Dual 5 <sup>th</sup> Gen Processors Installed Normal Operating Mode (Table 4 of 4) (M50FCP2UR208 x16 Drive with 1U Heat Sink).....	136
Table 59. Thermal Configuration Matrix with Dual 4 <sup>th</sup> Gen Processors Installed Normal Operating Mode (Table 1 of 4) (M50FCP2UR x8 Drive with 2U Heat Sink).....	138
Table 60. Thermal Configuration Matrix with Dual 4 <sup>th</sup> Gen Processors Installed Normal Operating Mode (Table 2 of 4) (M50FCP2UR x8 Drive with 1U Heat Sink).....	142
Table 61. Thermal Configuration Matrix with Dual 5 <sup>th</sup> Gen Processors Installed Normal Operating Mode (Table 3 of 4) (M50FCP2UR x8 Drive with 2U Heat Sink).....	145
Table 62. Thermal Configuration Matrix with Dual 5 <sup>th</sup> Gen Processors Installed Normal Operating Mode (Table 4 of 4) (M50FCP2UR x8 Drive with 1U Heat Sink).....	149
Table 63. Thermal Configuration Matrix with Dual 4 <sup>th</sup> Gen Processors Installed Normal Operating Mode (Table 1 of 4) (M50FCP2UR312 with 2U Heat Sink).....	151
Table 64. Thermal Configuration Matrix with Dual 4 <sup>th</sup> Gen Processors Installed – Normal Operating Mode (Table 2 of 4) (M50FCP2UR312 with 1U Heat Sink).....	155
Table 65. Thermal Configuration Matrix with Dual 5 <sup>th</sup> Gen Processors Installed Normal Operating Mode (Table 3 of 4) (M50FCP2UR312 with 2U Heat Sink).....	158
Table 66. Thermal Configuration Matrix with Dual 5 <sup>th</sup> Gen Processors Installed Normal Operating Mode (Table 4 of 4) (M50FCP2UR312 with 1U Heat Sink).....	160

Table 67. Thermal Configuration Matrix with Single 4 <sup>th</sup> Gen Processors Installed Normal Operating Mode (Table 1 of 4) (M50FCP2UR208 x24 Drive with 2U Heat Sink).....	163
Table 68. Thermal Configuration Matrix with Single 4 <sup>th</sup> Gen Processors Installed Normal Operating Mode (Table 2 of 4) (M50FCP2UR208 x24 Drive with 1U Heat Sink).....	167
Table 69. Thermal Configuration Matrix with Single 5 <sup>th</sup> Gen Processors Installed Normal Operating Mode (Table 3 of 4) (M50FCP2UR208 x24 Drive with 2U Heat Sink).....	170
Table 70. Thermal Configuration Matrix with Single 5 <sup>th</sup> Gen Processors Installed Normal Operating Mode (Table 4 of 4) (M50FCP2UR208 x24 Drive with 1U Heat Sink).....	173
Table 71. Thermal Configuration Matrix with Single 4 <sup>th</sup> Gen Processors Installed Normal Operating Mode (Table 1 of 4) (M50FCP2UR x16 Drive with 2U Heat Sink).....	175
Table 72. Thermal Configuration Matrix with Single 4 <sup>th</sup> Gen Processors Installed Normal Operating Mode (Table 2 of 4) (M50FCP2UR x16 Drive with 1U Heat Sink).....	179
Table 73. Thermal Configuration Matrix with Single 5 <sup>th</sup> Gen Processors Installed Normal Operating Mode (Table 3 of 4) (M50FCP2UR x16 Drive with 2U Heat Sink).....	182
Table 74. Thermal Configuration Matrix with Single 5 <sup>th</sup> Gen Processors Installed Normal Operating Mode (Table 4 of 4) (M50FCP2UR x16 Drive with 1U Heat Sink).....	185
Table 75. Thermal Configuration Matrix with Single 4 <sup>th</sup> Gen Processors Installed Normal Operating Mode (Table 1 of 4) (M50FCP2UR x8 Drive with 2U Heat Sink).....	188
Table 76. Thermal Configuration Matrix with Single 4 <sup>th</sup> Gen Processors Installed Normal Operating Mode (Table 2 of 4) (M50FCP2UR x8 Drive with 1U Heat Sink).....	192
Table 77. Thermal Configuration Matrix with Single 5 <sup>th</sup> Gen Processors Installed Normal Operating Mode (Table 3 of 4) (M50FCP2UR208 Drive with 2U Heat Sink).....	195
Table 78. Thermal Configuration Matrix with Single 5 <sup>th</sup> Gen Processors Installed Normal Operating Mode (Table 4 of 4) (M50FCP2UR208 Drive with 1U Heat Sink).....	198
Table 79. Thermal Configuration Matrix with Single Processors Installed Normal Operating Mode (Table 1 of 4) (M50FCP2UR312 with 2U Heat Sink).....	201
Table 80. Thermal Configuration Matrix with Single 4 <sup>th</sup> Gen Processors Installed Normal Operating Mode (Table 2 of 4) (M50FCP2UR312 with 1U Heat Sink).....	204
Table 81. Thermal Configuration Matrix with Single 5 <sup>th</sup> Gen Processors Installed Normal Operating Mode (Table 3 of 4) (M50FCP2UR312 with 2U Heat Sink).....	206
Table 82. Thermal Configuration Matrix with Single 5 <sup>th</sup> Gen Processors Installed Normal Operating Mode (Table 4 of 4) (M50FCP2UR312 with 1U Heat Sink).....	209
Table 83. SOV – Server Board Components.....	215
Table 84. SOV – System Board Components.....	215
Table 85. SOV – Server Chassis Components.....	215

# 1. Introduction

---

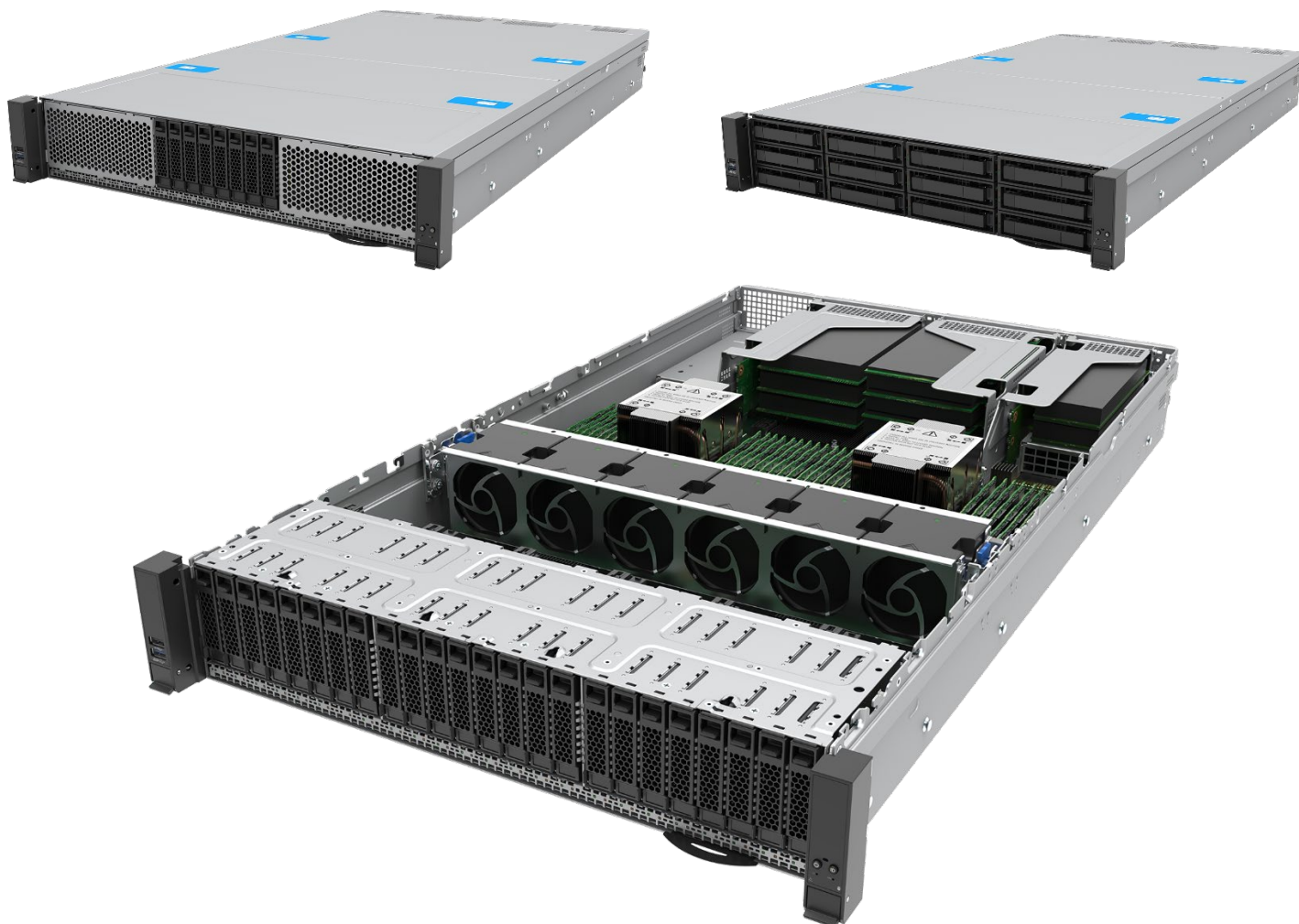
This technical product specification (TPS) provides a high-level overview of the features, functions, architecture, and support specifications of the Intel® Server System M50FCP2UR.

The Intel® Server System M50FCP2UR is a purpose built, storage-optimized system that delivers power and performance at a peak efficiency in a 2U rack mount server form factor. This server system features the 4<sup>th</sup> & 5<sup>th</sup> Gen Intel® Xeon® Scalable processor family in a dual-socket configuration, delivering high core count and new hardware-enhanced security features. Previous generation of the Intel® Xeon® processor and Intel® Xeon® Scalable processor families are not supported.

The system provides high memory bandwidth and capacity of up to 32 memory modules for memory intensive workloads.

The server system has high memory capacity, high-speed networking, storage up to 24 SAS/SATA/NVMe\* drive bays, and I/O flexibility. These capabilities are combined with innovative design to provide an exceptional and reliable server for business IT, appliance, data center, cloud, and high-performance computing applications.

For a complete overview of system features and functions, both this system TPS and the *Intel® Server Board M50FCP2SBSTD Technical Product Specification (TPS)* should be referenced.



**Figure 1. Intel® Server System M50FCP2UR Family**

## 1.1 Reference Documents

For additional information and other support collaterals related to this Intel® server product, see Table 1. Listed documents and utilities can be downloaded from the following Intel websites or can be ordered through a local Intel support representative.

Note: Some of the Intel documents listed in Table 1 are classified as “Intel Confidential”. These documents are only made available under a nondisclosure agreement (NDA) with Intel. All Intel product documentation and support collaterals can be downloaded from Intel's Resource & Documentation Center website: <https://www.intel.com/content/www/us/en/documentation-resources/developer.html>

For support 5<sup>th</sup> Gen Intel® Xeon® Scalable processor family, system board software stack needs to be in R01.02.0001 version or later. A System Update Package (SUP) with the latest system software stack can be downloaded from the following Intel website: <http://downloadcenter.intel.com>

**Table 1. Intel® Server M50FCP Family Reference Documents and Support Collaterals**

Topic	Document Title or Support Collateral	Document Classification
System integration instructions and service guidance	<i>Intel® Server System M50FCP2UR System Integration and Service Guide</i>	<a href="#">Public</a>
System integration instructions and service guidance	<i>Intel® Server System M50FCP1UR System Integration and Service Guide</i>	<a href="#">Public</a>
Technical system-level description	<i>Intel® Server System M50FCP2UR Technical Product Specification</i>	<a href="#">Public</a>
Technical system-level description	<i>Intel® Server System M50FCP1UR Technical Product Specification</i>	<a href="#">Public</a>
Technical board-level description	<i>Intel® Server Board M50FCP2SBSTD Technical Product Specification</i>	<a href="#">Public</a>
Server configuration guidance and compatibility	<i>Intel® Server M50FCP Family Configuration Guide</i>	<a href="#">Public</a>
Information on the Integrated BMC Web Console	<i>Integrated Baseboard Management Controller Web Console (Integrated BMC Web Console) User Guide</i>	<a href="#">Public</a>
BIOS technical information on product family	<i>BIOS Firmware External Product Specification (EPS)</i>	Intel Confidential
BIOS setup information on product family	<i>BIOS Setup Utility User Guide</i>	<a href="#">Public</a>
BMC technical information on product family	<i>Integrated Baseboard Management Controller Firmware External Product Specification (EPS)</i>	Intel Confidential
Base specifications for the IPMI architecture and interfaces	<i>Intelligent Platform Management Interface Specification Second Generation v2.0</i>	Intel Confidential
Specifications for the PCIe* 3.0 architecture and interfaces	<i>PCIe Base Specification, Revision 3.0</i> <a href="http://www.pcisig.com/specifications">http://www.pcisig.com/specifications</a>	Public
Specifications for the PCIe* 4.0 architecture and interfaces	<i>PCIe Base Specification, Revision 4.0</i> <a href="http://www.pcisig.com/specifications">http://www.pcisig.com/specifications</a>	Public
Specifications for the PCIe* 5.0 architecture and interfaces	<i>PCIe Base Specification, Revision 5.0</i> <a href="http://www.pcisig.com/specifications">http://www.pcisig.com/specifications</a>	Public
Specification for OCP*	<i>Open Compute Project (OCP) 3.0 Specification</i>	Intel Confidential
Specifications of Trust Domain Extensions (Depends on 5 <sup>th</sup> Gen processor)	<i>Intel® Trust Domain Extension (Intel® TDX) White Paper</i>	<a href="#">Public</a>
TPM for PC Client specifications	<i>TPM PC Client Specifications, Revision 2.0</i>	Intel Confidential

Intel® Server System M50FCP2UR Technical Product Specification

Topic	Document Title or Support Collateral	Document Classification
Functional specifications of 4 <sup>th</sup> Gen Intel® Xeon® Scalable processor family	<i>Sapphire Rapids External Design Specification (EDS)</i> : Document IDs: 630161, 612246, 612172, 633350, 611488	Intel Confidential
Specifications of 5 <sup>th</sup> Gen Intel® Xeon® Scalable processor family	<i>Emerald Rapids External Design Specification (EDS)</i> : Document IDs: 721175, 723370	Intel Confidential
Processor thermal design specifications and recommendations	<i>Sapphire Rapids Thermal and Mechanical Specifications and Design Guide (TMSDG)</i> : Document ID 609847	Intel Confidential
BIOS and BMC security best practices	<i>Intel® Server Systems Baseboard Management Controller (BMC) and BIOS Security Best Practices White Paper</i> <a href="https://www.intel.com/content/www/us/en/support/articles/000055785/server-products.html">https://www.intel.com/content/www/us/en/support/articles/000055785/server-products.html</a>	Public
Managing an Intel server overview	<i>Managing an Intel Server System 2020</i> <a href="https://www.intel.com/content/www/us/en/support/articles/000057741/server-products.html">https://www.intel.com/content/www/us/en/support/articles/000057741/server-products.html</a>	Public
Latest system software updates: BIOS and firmware	<i>Intel® System Update Package (SUP) for Intel® Server M50FCP Family</i>	<a href="#">Public</a>
	<i>Intel® Server Firmware Update Utility - Various operating system support</i>	
	<i>Intel® Server Firmware Update Utility User Guide</i>	
To obtain full system information	<i>Intel® Server Information Retrieval Utility - Various operating system support</i>	<a href="#">Public</a>
	<i>Intel® Server Information Retrieval Utility User Guide</i>	
To configure, save, and restore various system options	<i>Intel® Server Configuration Utility - Various operating system support</i>	<a href="#">Public</a>
	<i>Intel® Server Configuration Utility User Guide</i>	
Product Warranty Information	<i>Warranty Terms and Conditions</i> <a href="https://www.intel.com/content/www/us/en/support/services/000005886.html">https://www.intel.com/content/www/us/en/support/services/000005886.html</a>	Public
Intel® Data Center Manager (Intel® DCM) information	<i>Intel® Data Center Manager (Intel® DCM) Product Brief</i> <a href="https://software.intel.com/content/www/us/en/develop/download/dcm-product-brief.html">https://software.intel.com/content/www/us/en/develop/download/dcm-product-brief.html</a>	Public
	<i>Intel® Data Center Manager (Intel® DCM) Console User Guide</i> <a href="https://software.intel.com/content/www/us/en/develop/download/dcm-user-guide.html">https://software.intel.com/content/www/us/en/develop/download/dcm-user-guide.html</a>	Public

**Note:** Intel Confidential documents are made available under a nondisclosure agreement (NDA) with Intel and must be ordered through your local Intel representative.



## 2. Server System Family Overview

This chapter provides a general overview of the Intel® Server System M50FCP2UR. More in depth information can be found in the following chapters. Additional information specific to the server board can be found by referencing the *Intel® Server Board M50FCP2SBSTD Technical Product Specification*.

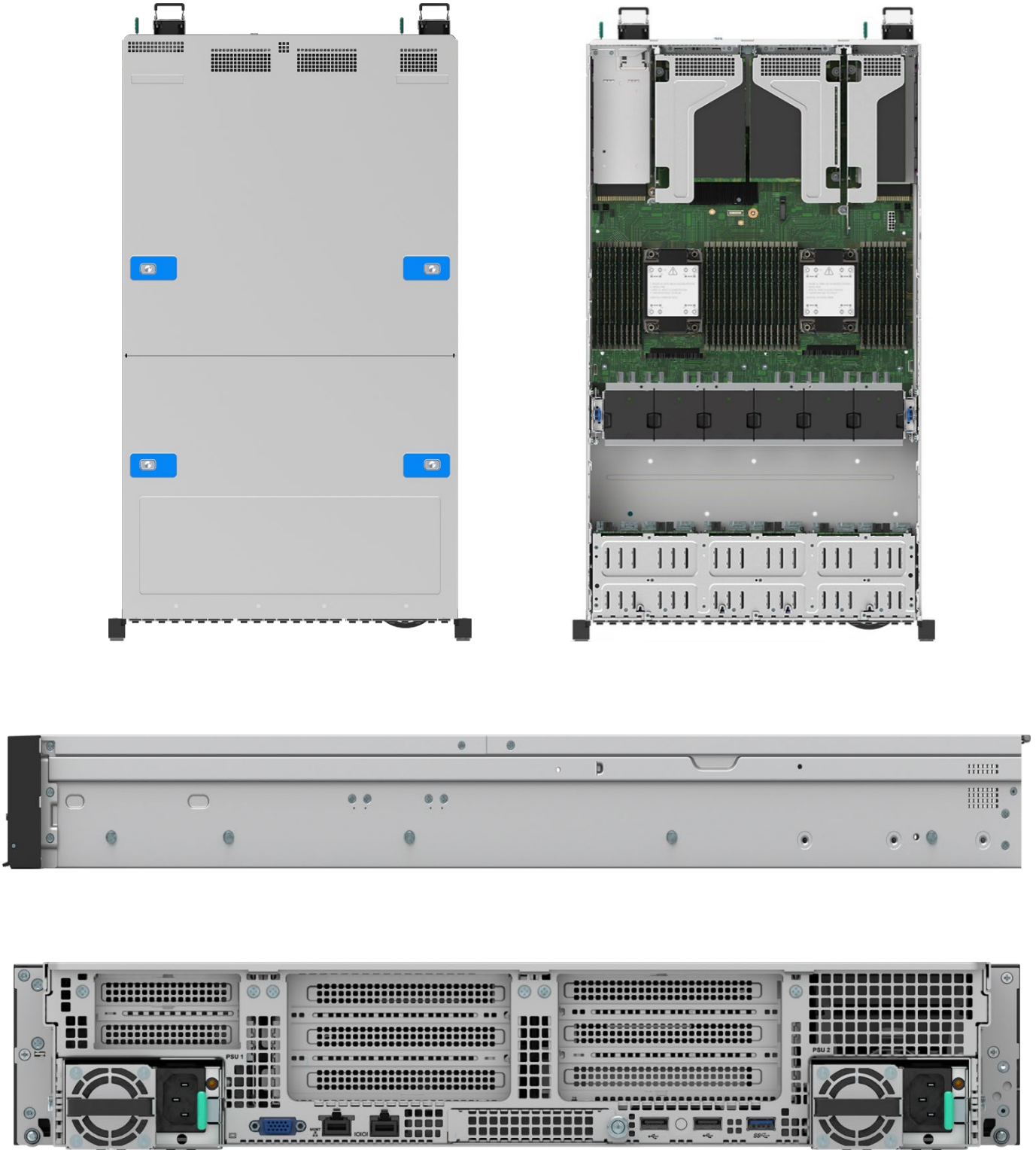


Figure 2. Intel® Server M50FCP2UR System Views (Top, Side, and Back)

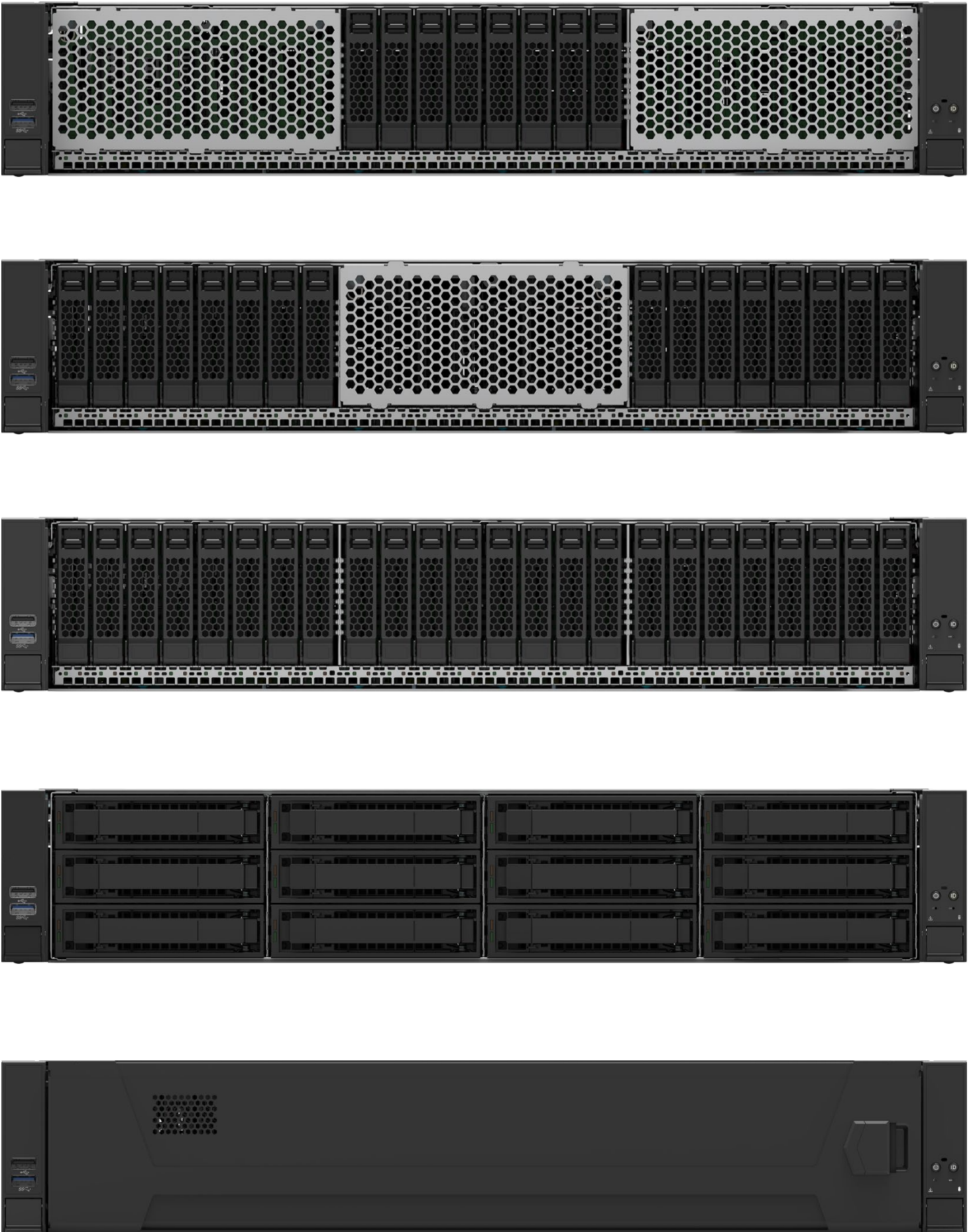


Figure 3. Intel® Server M50FCP2UR System Views (Front Drive Bay Configurations)

## 2.1 Server System Feature Set

The following table provides a high-level overview of the features and available options supported by the Intel® Server System M50FCP2UR.

**Table 2. Intel® Server System M50FCP2UR Features**

Feature	Details
<b>Chassis Type</b>	2U rack mount chassis
<b>Chassis Dimensions</b>	769.6 x 438 x 87 mm (L x W x H)
<b>Server Board</b>	Intel® Server Board M50FCP2SBSTD
<b>Processor Support</b>	<ul style="list-style-type: none"> <li>• Dual Socket- E LGA4677</li> <li>• Supported 4<sup>th</sup> &amp; 5<sup>th</sup> Gen Intel® Xeon® Scalable processor family SKUs: <ul style="list-style-type: none"> <li>○ Intel® Xeon® Platinum 84xxx/85xxxx processor</li> <li>○ Intel® Xeon® Gold 64xxx/65xxxx processor</li> <li>○ Intel® Xeon® Gold 54xxx/55xxxx processor</li> <li>○ Intel® Xeon® Silver 44xxx/45xxxx processor</li> <li>○ Intel® Xeon® Bronze 34xxx/35xxxx processor</li> </ul> </li> <li>• Intel® UPI links: up to 3 at 16 GT/s (4<sup>th</sup> Gen Intel® Xeon® Platinum and Gold families) or up to 2 at 16 GT/s (Silver family)</li> <li>• Intel® UPI links: up to 3 at 20 GT/s (5<sup>th</sup> Gen Intel® Xeon® Platinum and Gold families) or up to 2 at 16 GT/s (Silver family)</li> <li>• Intel® Xeon® Bronze processors are used in single processor configurations only.</li> </ul> <p><b>Notes:</b> Previous generation Intel® Xeon® processor and Intel® Xeon® Scalable processor families are not supported. For processor support details, see the Intel® Server Board M50FCP2SBSTD Technical Product Specification.</p>
<b>Maximum Supported Processor Thermal Design Power (TDP)</b>	Up to 350 W. <b>Note:</b> The maximum supported processor TDP is dependent on the system configuration. See product TPS for additional information
<b>Chipset</b>	<ul style="list-style-type: none"> <li>• Intel® C741 chipset platform controller hub (PCH)</li> <li>• Embedded features enabled on this server board: <ul style="list-style-type: none"> <li>○ SATA 3.0 support</li> <li>○ USB 3.0 support</li> <li>○ PCIe 3.0 support</li> </ul> </li> </ul>
<b>Memory Support</b>	<ul style="list-style-type: none"> <li>• 32 memory slots <ul style="list-style-type: none"> <li>○ 16 memory slots per processor, eight memory channels per processor</li> <li>○ Two memory modules per channel</li> </ul> </li> <li>• Registered DDR5 DIMM (standard RDIMM, 3DS-RDIMM, and 9x4 RDIMM) <b>Note:</b> 3DS = 3-dimensional stacking.</li> <li>• All DDR5 DIMMs must support ECC</li> <li>• Memory capacity Up to 4 TB per processor (processor SKU dependent) using DDR5 DIMMs</li> <li>• Memory data transfer rates <ul style="list-style-type: none"> <li>○ Up to 5600 MT/s at one DIMM per channel (Supported on 5<sup>th</sup> Gen Intel® Xeon® Scalable processor)</li> <li>○ Up to 4400 MT/s at two DIMMs per channel (processor SKU dependent)</li> </ul> </li> <li>• DDR5 standard voltage of 1.1 V</li> </ul> <p><b>Note:</b> For memory support details, see the <i>Intel® Server Board M50FCP2SBSTD Technical Product Specification</i>. Pending validation results for DDR5 DIMM size 256GB.</p>
<b>System Fan Support</b>	<ul style="list-style-type: none"> <li>• Six managed 60-mm hot swap capable system fans</li> <li>• Integrated fans included with each installed power supply module</li> </ul>

Feature	Details
<b>Power Supply Options</b>	<ul style="list-style-type: none"> <li>• The server system can support one or two power supply modules configurations.</li> <li>• Depending on the power supply configuration, the system will support the following power operating modes: <ul style="list-style-type: none"> <li>○ 1+0 – Single functional power supply</li> <li>○ 1+1 – redundant power</li> <li>○ 2+0 – combined power, no redundancy</li> </ul> </li> <li>• Power supply options: <ul style="list-style-type: none"> <li>○ AC 1300 W Titanium</li> <li>○ AC 1600 W Titanium</li> <li>○ AC 2100 W Platinum</li> </ul> </li> </ul>
<b>Onboard Network Support</b>	<ul style="list-style-type: none"> <li>• Provided by optional Open Compute Project* (OCP*) adapter support.</li> </ul>
<b>Open Compute Project* (OCP*) Adapter Support</b>	<ul style="list-style-type: none"> <li>• Server board x16 PCIe 5.0 OCP 3.0 connector (Small Form-Factor) slot. Refer to <a href="https://servertools.intel.com/sct">https://servertools.intel.com/sct</a> for the latest list of adapters supported by the server board.</li> </ul>
<b>Riser Card Support</b>	<p>Concurrent support for up to three riser cards with support for up to eight PCIe add-in cards. In the following description FH = Full Height, FL = Full Length, HL =Half Length, LP = Low Profile.</p> <p><b>Riser Slot #1</b></p> <ul style="list-style-type: none"> <li>• Riser Slot #1 supports x32 PCIe lanes, routed from CPU 0</li> <li>• PCIe 5.0 support for up to 64 GB/s</li> </ul> <p><b>Riser Slot #1 supports the following Intel riser card options:</b></p> <ul style="list-style-type: none"> <li>• Two PCIe slot riser card (iPC <b>FCP2URISER1DW</b>), which support: <ul style="list-style-type: none"> <li>○ One FH/FL double-width slot (x16 electrical, x16 mechanical)</li> <li>○ One FH/HL single-width slot (x16 electrical, x16 mechanical)</li> </ul> </li> <li>• Two PCIe slot riser card (iPC <b>FCP2URISER1SW</b>), which support: <ul style="list-style-type: none"> <li>○ Two FH/FL single-width slot (x16 electrical, x16 mechanical)</li> </ul> </li> <li>• Three PCIe slot riser card (iPC <b>FCP2URISER1STD</b>), which support: <ul style="list-style-type: none"> <li>○ One FH/FL single-width slot (x16 electrical, x16 mechanical)</li> <li>○ One FH/FL single-width slot (x8 electrical, x16 mechanical)</li> <li>○ One FH/HL single-width slot (x8 electrical, x8 mechanical)</li> </ul> </li> <li>• NVMe riser card (iPC <b>FCP2URISER1RTM</b>), which supports: <ul style="list-style-type: none"> <li>○ One HL or FL single-width slot (x16 electrical, x16 mechanical)</li> <li>○ Two x8 PCIe NVMe MCIO connectors, each with a re-timer</li> </ul> </li> </ul> <p><b>Riser Slot #2</b></p> <ul style="list-style-type: none"> <li>• Riser Slot #2 supports x32 PCIe lanes, routed from CPU 1</li> <li>• PCIe 5.0 support for up to 64 GB/s</li> </ul> <p><b>Riser Slot #2 supports the following Intel riser card options:</b></p> <ul style="list-style-type: none"> <li>• Two PCIe slot riser card (iPC <b>FCP2URISER2DW</b>), which support: <ul style="list-style-type: none"> <li>○ One FH/FL double-width slot (x16 electrical, x16 mechanical)</li> <li>○ One FH/HL single-width slot (x16 electrical, x16 mechanical)</li> </ul> </li> <li>• Two PCIe slot riser card (iPC <b>FCP2URISER2SW</b>), which support: <ul style="list-style-type: none"> <li>○ Two FH/FL single-width slot (x16 electrical, x16 mechanical)</li> </ul> </li> <li>• Three PCIe slot riser card (iPC <b>FCP2URISER2STD</b>), which support: <ul style="list-style-type: none"> <li>○ One FH/FL single-width slot (x16 electrical, x16 mechanical)</li> <li>○ One FH/FL single-width slot (x8 electrical, x16 mechanical)</li> <li>○ One FH/HL single-width slot (x8 electrical, x8 mechanical)</li> </ul> </li> </ul> <p><b>Riser Slot #3</b></p> <ul style="list-style-type: none"> <li>• Riser Slot #3 supports x16 PCIe lanes, routed from CPU 1</li> <li>• PCIe 5.0 support for up to 32 GB/s</li> </ul> <p><b>Riser Slot #3 supports the following Intel riser card options:</b></p> <ul style="list-style-type: none"> <li>• Two PCIe slot riser card (iPC <b>FCP2URISER3STD</b>), which support: <ul style="list-style-type: none"> <li>○ Two LP/HL single-width slots (x16 mechanical, x8 electrical)</li> </ul> </li> <li>• NVMe riser card (iPC <b>CYPRISER3RTM</b>), which supports: <ul style="list-style-type: none"> <li>○ Two PCIe NVMe SlimSAS connectors with re-timers</li> </ul> </li> </ul>

## Intel® Server System M50FCP2UR Technical Product Specification

Feature	Details
<b>Onboard PCIe* NVMe* Support</b>	<ul style="list-style-type: none"> <li>• Supports up to 18 PCIe NVMe interconnects                             <ul style="list-style-type: none"> <li>○ 16 server board MCIO cable connectors, eight per processor</li> <li>○ Two M.2 NVMe/SATA SSD connectors</li> </ul> </li> <li>• Additional NVMe support through select Riser Card options (see Riser Card Support)</li> <li>• Intel® Volume Management Device (Intel® VMD) 3.0 support</li> <li>• Intel® Virtual RAID on CPU NVMe (Intel® VROC NVMe) 8.0.                             <ul style="list-style-type: none"> <li>○ Requires installation of an Intel® VROC for NVMe License Activation Key accessory option. This accessory option is a software key that enables RAID support for NVMe SSDs interfaced through the onboard PCIe MCIO connectors. Depending on the option installed, RAID levels supported are 0,1,10 or 0,1,5,10.</li> </ul> </li> </ul>
<b>Video Support</b>	<ul style="list-style-type: none"> <li>• Integrated 2D video controller</li> <li>• 128 MB of DDR4 video memory</li> <li>• One VGA connector on the rear of the chassis</li> </ul>
<b>Onboard SATA Support</b>	<ul style="list-style-type: none"> <li>• 10 x SATA 3.0 ports (6 Gb/s, 3 Gb/s, and 1.5 Gb/s transfer rates supported)                             <ul style="list-style-type: none"> <li>○ Two M.2 connectors: SATA/PCIe</li> <li>○ Two 4-port Mini-SAS HD (SFF-8643) connectors</li> </ul> </li> <li>• Intel® Virtual RAID on CPU for SATA (Intel® VROC for SATA) 8.0                             <ul style="list-style-type: none"> <li>○ Support for RAID levels 0,1,5,10 (Standard feature, no additional upgrade key required)</li> </ul> </li> </ul>
<b>USB Support</b>	<ul style="list-style-type: none"> <li>• One USB 3.0 and two USB 2.0 connectors on the rear of the chassis</li> <li>• One USB 3.0 and one USB 2.0 connector on the front panel</li> </ul>
<b>Serial Support</b>	<ul style="list-style-type: none"> <li>• One external RJ-45 Serial Port A connector on the rear of the chassis</li> </ul>
<b>Front Drive Bay Options</b>	<ul style="list-style-type: none"> <li>• 8 x 2.5" SAS/SATA/NVMe hot swap drive bays – iPC M50FCP2UR208</li> <li>• 16 x 2.5" SAS/SATA/NVMe hot swap drive bays - iPC M50FCP2UR208 with installed accessory kits</li> <li>• 24 x 2.5" SAS/SATA/NVMe hot swap drive bays - iPC M50FCP2UR208 with installed accessory kits</li> <li>• 12 x 3.5" SAS/SATA hot swap drive bays (supports up to 4 NVMe drives) - iPC M50FCP2UR312</li> </ul>
<b>Server Management</b>	<ul style="list-style-type: none"> <li>• Integrated Baseboard Management Controller (BMC)</li> <li>• One dedicated RJ45 1 GbE server management port</li> <li>• Intelligent Platform Management Interface (IPMI) 2.0 compliant</li> <li>• Redfish* compliant</li> <li>• Support for Intel® Data Center Manager (Intel® DCM)</li> <li>• Support for Intel® Server Debug and Provisioning Tool (Intel® SDP Tool)</li> <li>• Support for Intel® Server Management Software</li> <li>• Intel® Light-Guided Diagnostics</li> <li>• Optional Advanced Server Management features (Purchased separately)</li> </ul>
<b>Server Management Processor (SMP)</b>	<ul style="list-style-type: none"> <li>• Aspeed AST2600* Advanced PCIe Graphics and Remote Management Processor</li> <li>• Embedded features enabled on this server board:                             <ul style="list-style-type: none"> <li>○ Baseboard Management Controller (BMC)</li> <li>○ 2D Video Graphics Adapter</li> </ul> </li> </ul>
<b>System Configuration and Recovery Jumpers</b>	<ul style="list-style-type: none"> <li>• BIOS load defaults</li> <li>• BIOS password clear</li> <li>• Intel® Management Engine firmware force update Jumper</li> <li>• BIOS_SVN downgrade</li> <li>• BMC_SVN downgrade</li> </ul>
<b>Security Features</b>	<ul style="list-style-type: none"> <li>• Intel® Platform Firmware Resilience (Intel® PFR) technology with an I2C interface</li> <li>• Intel® Software Guard Extensions (Intel® SGX)</li> <li>• Converged Intel® Boot Guard and Trusted Execution Technology (Intel® TXT)</li> <li>• Intel® Total Memory Encryption – Multi-Key (Intel® TME-MK)</li> <li>• Trusted platform module 2.0 (China version) – iPC AXXTMCHNE8 (accessory option)</li> <li>• Trusted platform module 2.0 (rest of the world) – iPC AXXTMENC9 (accessory option)</li> <li>• Intel® Trust Domain Extension (Supported on 5<sup>th</sup> Gen Intel® Xeon® Scalable processor)</li> </ul>
<b>Supported Rack Mount Kit Accessory Options (Sold separately)</b>	<ul style="list-style-type: none"> <li>• <b>CYPHALFEXTRAIL</b> – Value rack mount rail kit</li> <li>• <b>CYPFULLEXTRAIL</b> – Premium rail kit with cable management arm (CMA) support</li> <li>• <b>AXXCMA2</b> – CMA (supports <b>CYPFULLEXTRAIL</b> only)</li> </ul>
<b>BIOS</b>	<ul style="list-style-type: none"> <li>• Unified Extensible Firmware Interface (UEFI)-based BIOS (legacy boot not supported)</li> </ul>

## 2.2 System Feature Identification

This section provides system views and identifies key system features for all supported system configurations for the Intel® Server System M50FCP2UR options.

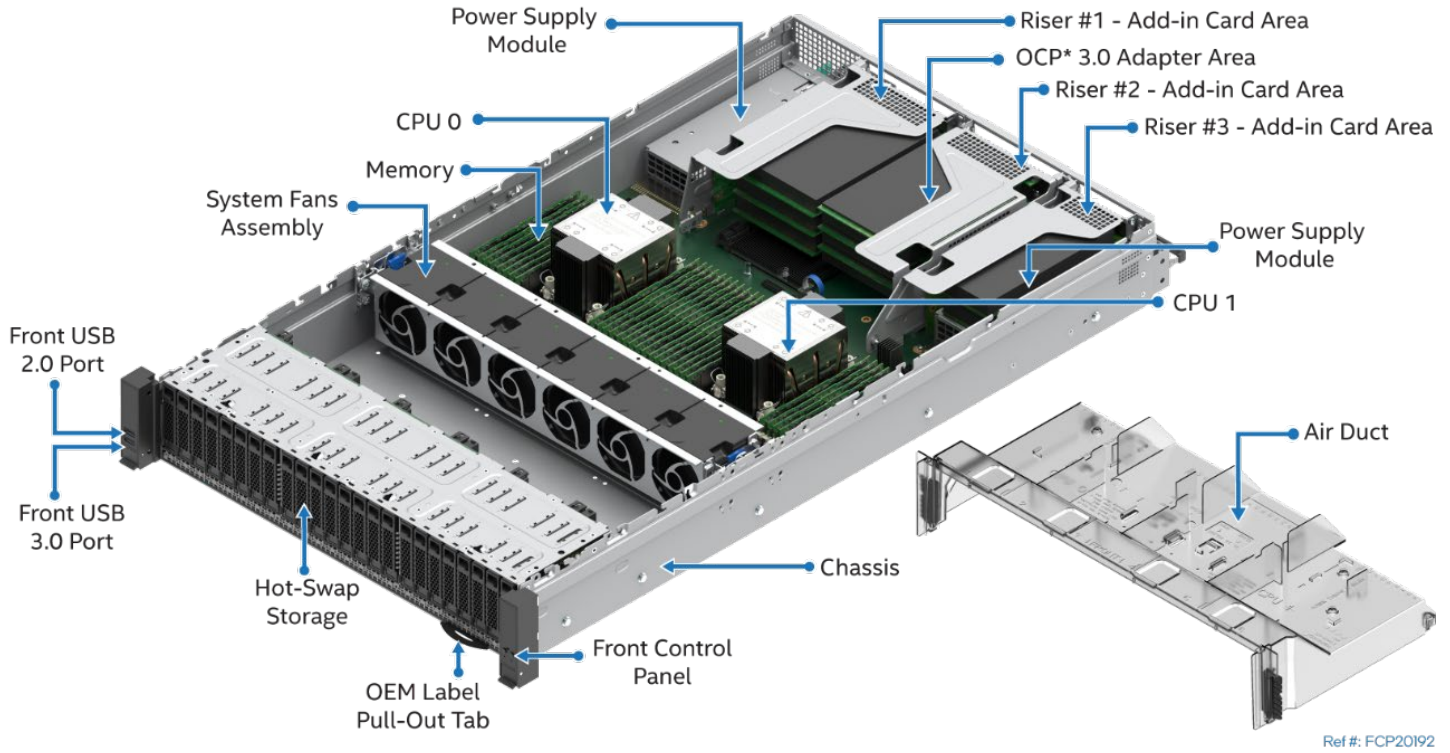


Figure 4. Server System Components Overview

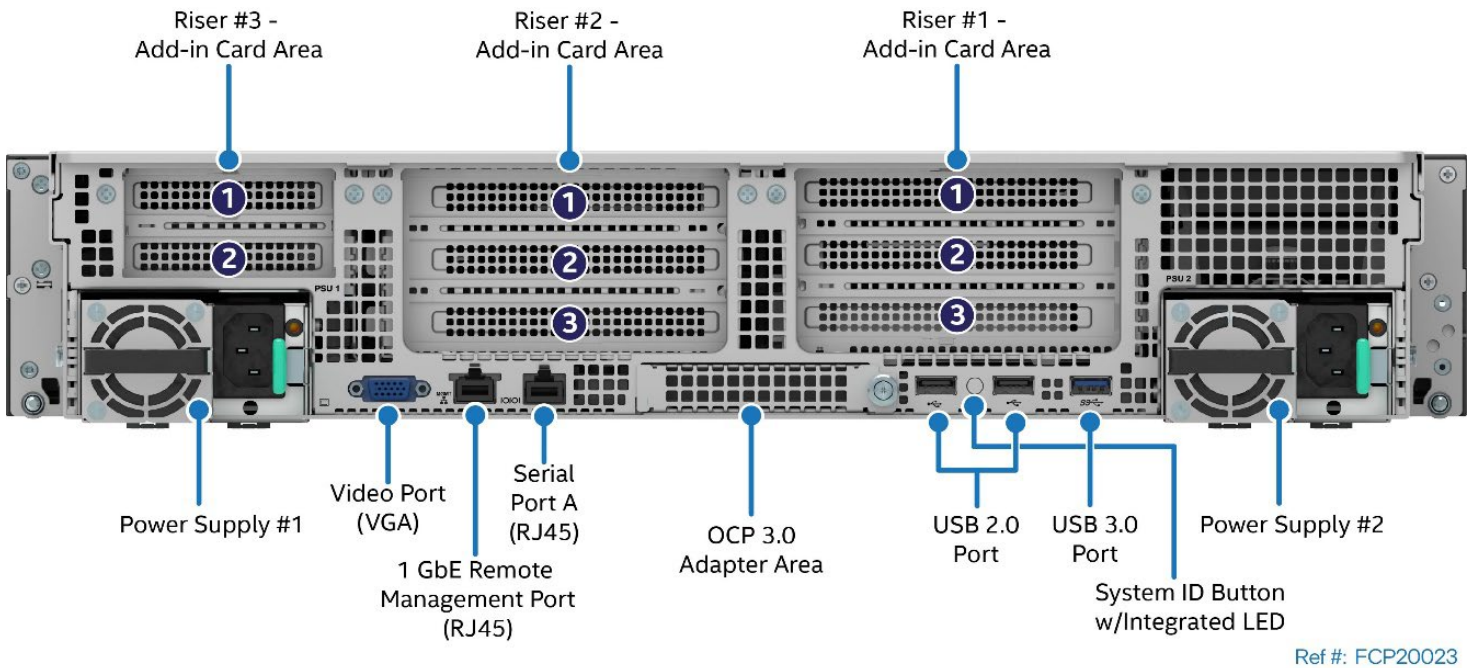
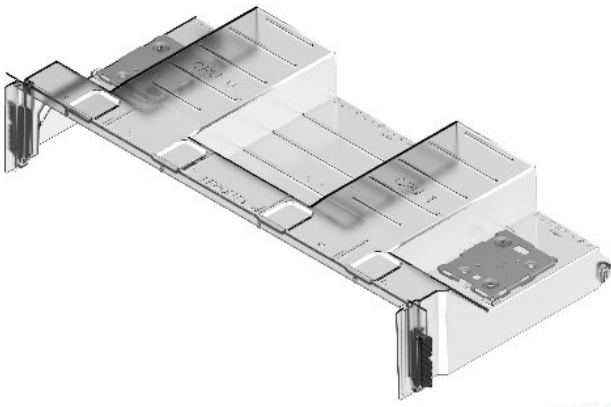
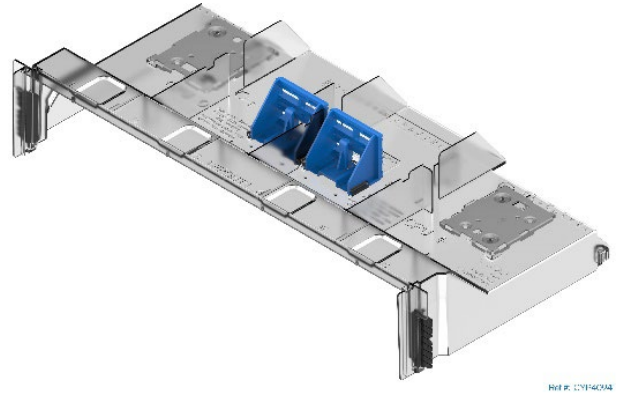


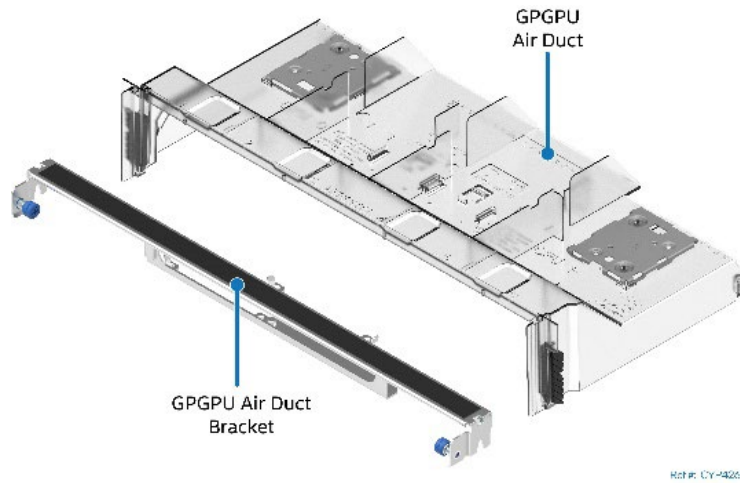
Figure 5. Back Panel Feature Identification



**Standard Air Duct (Default)**  
**(2U processor heat sink configurations)**



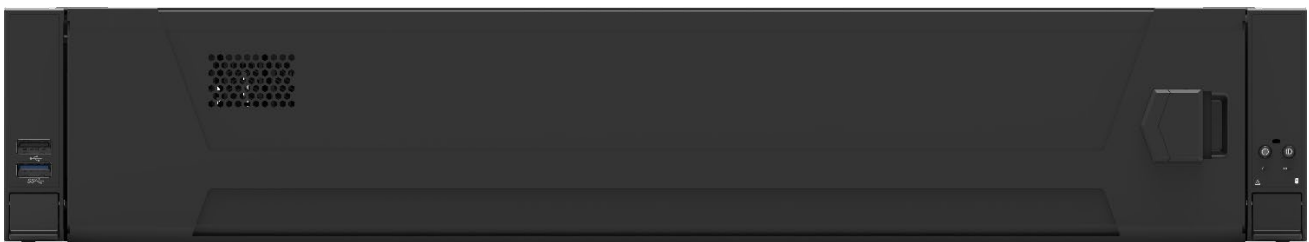
**Air Duct option (iPN - FCPDUCTCMN)**  
**(1U processor heat sink configurations)**



**GPGPU Air Duct option (iPN - FCPGPGPUKit)**  
**(1U processor heat sink + GPGPU configurations)**

**Figure 6. Air Duct Accessory Options**

## 2.3 Front Drive Bay Options



**Figure 7. System with Optional Front Bezel – iPC CYP2UBEZEL**



**Figure 8. 8 x 2.5" Front Drive Bay Configuration – M50FCP2UR208**



**Figure 9. 16 x 2.5" Front Drive Bay Configuration (M50FCP2UR208 with optional accessories)**



**Figure 10. 24 x 2.5" Front Drive Bay Configuration (M50FCP2UR208 with optional accessories)**



**Figure 11. 12 x 3.5" Front Drive Bay Configuration – M50FCP2UR312**



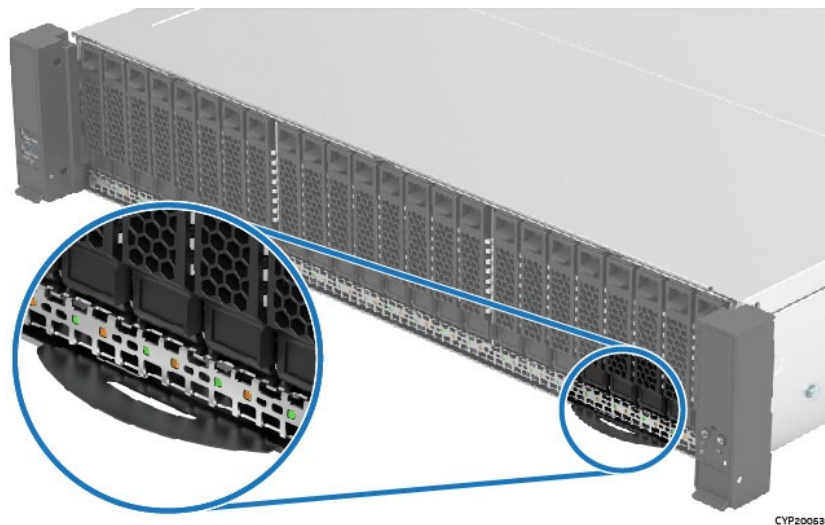
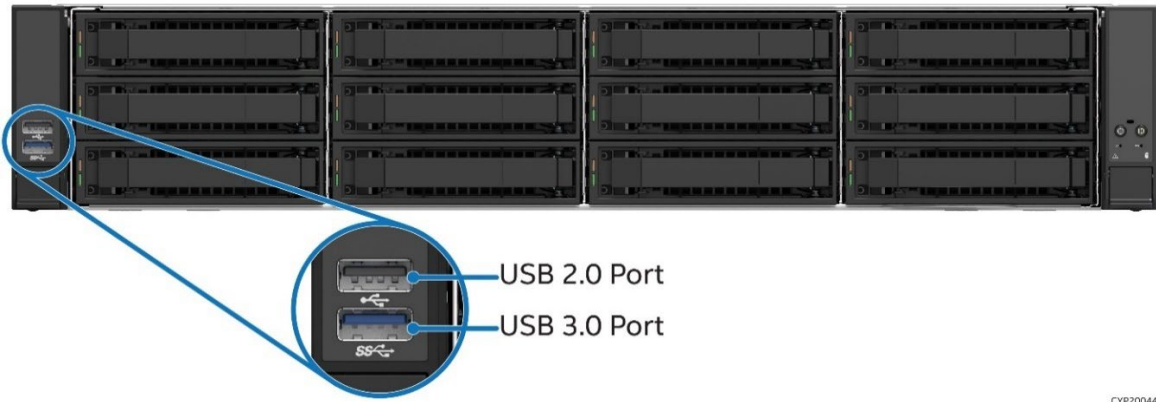
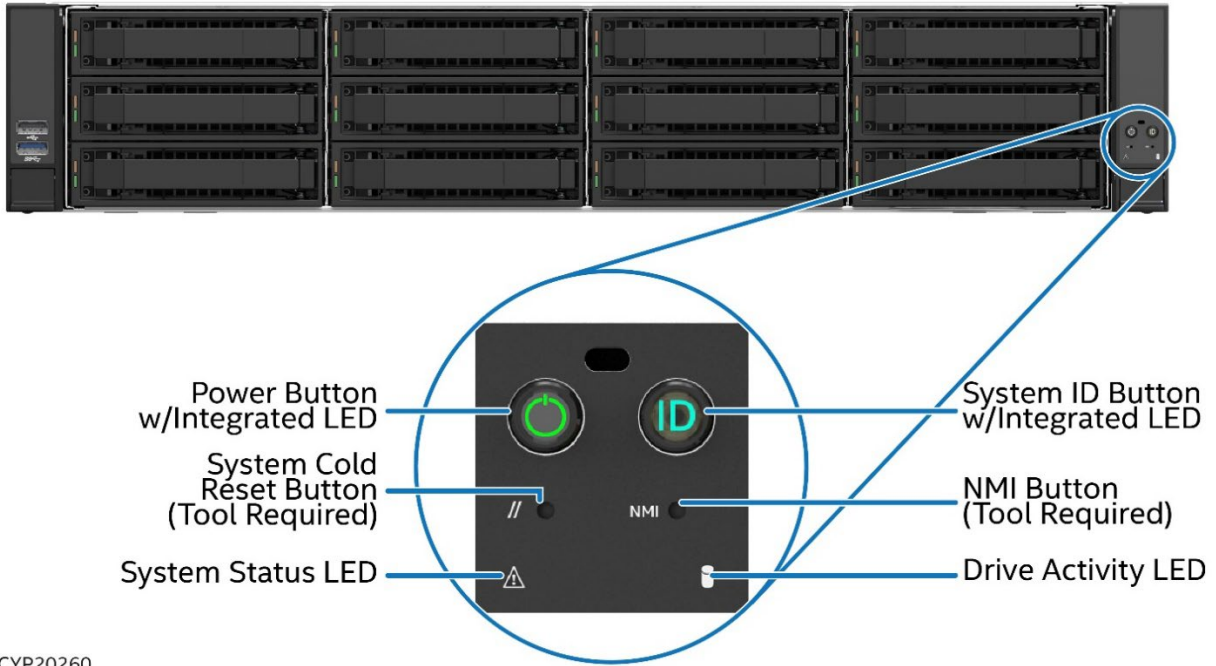


Figure 12. Front Panel Feature Identification

## 2.4 Server Board Features

Integrated within the Intel® Server System M50FCP2UR is the Intel® Server Board M50FCP2SBSTD. The architecture of the server board was developed around the integrated features and functions of the 4<sup>th</sup> & 5<sup>th</sup> Gen Intel® Xeon® Scalable processor family, Intel® C741 chipset PCH, and Aspeed AST2600\* Server Management Processor (SMP).

Figure 13 provides an overview of the server system architecture, showing the features and interconnects of the major subsystem components.

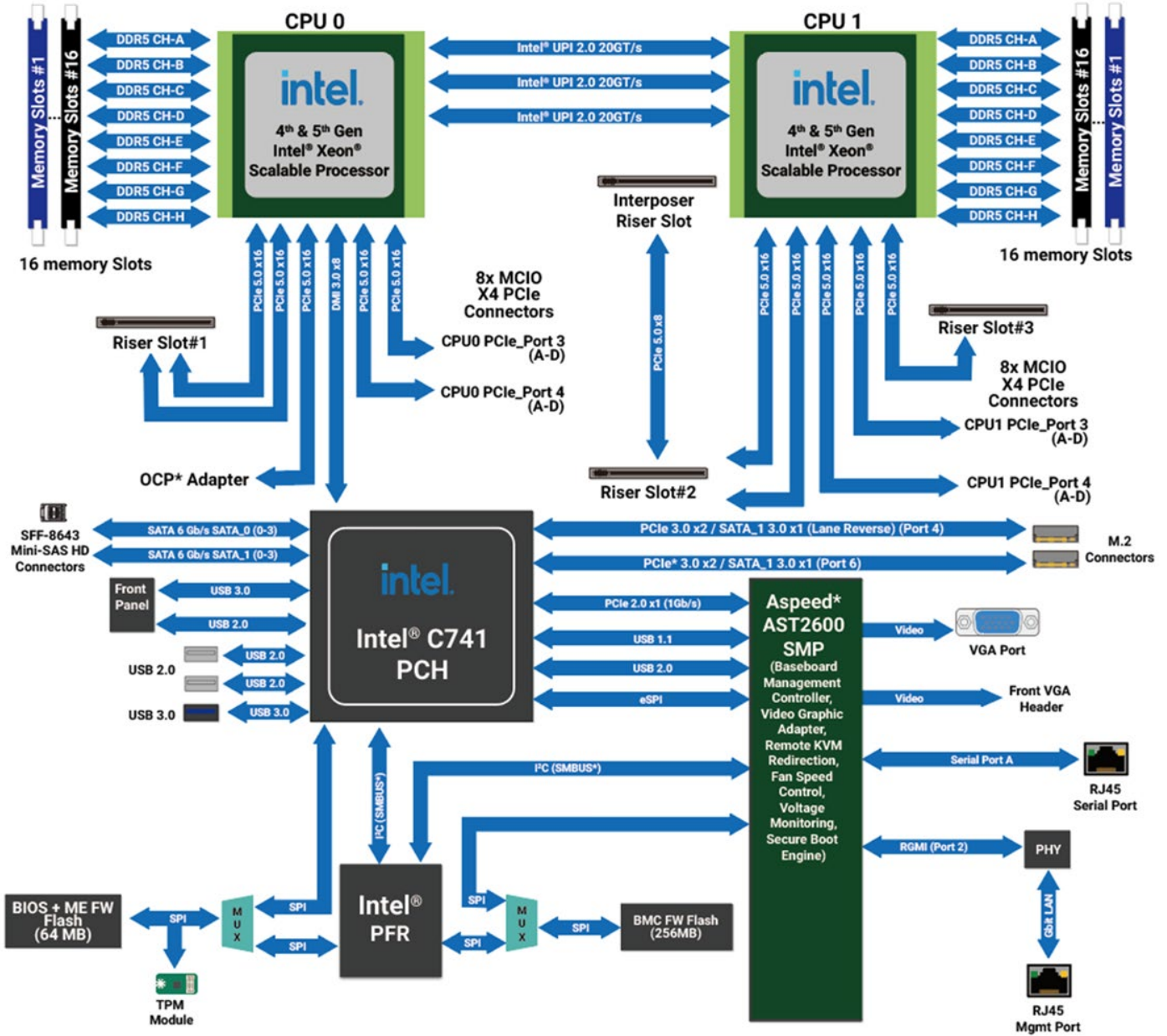
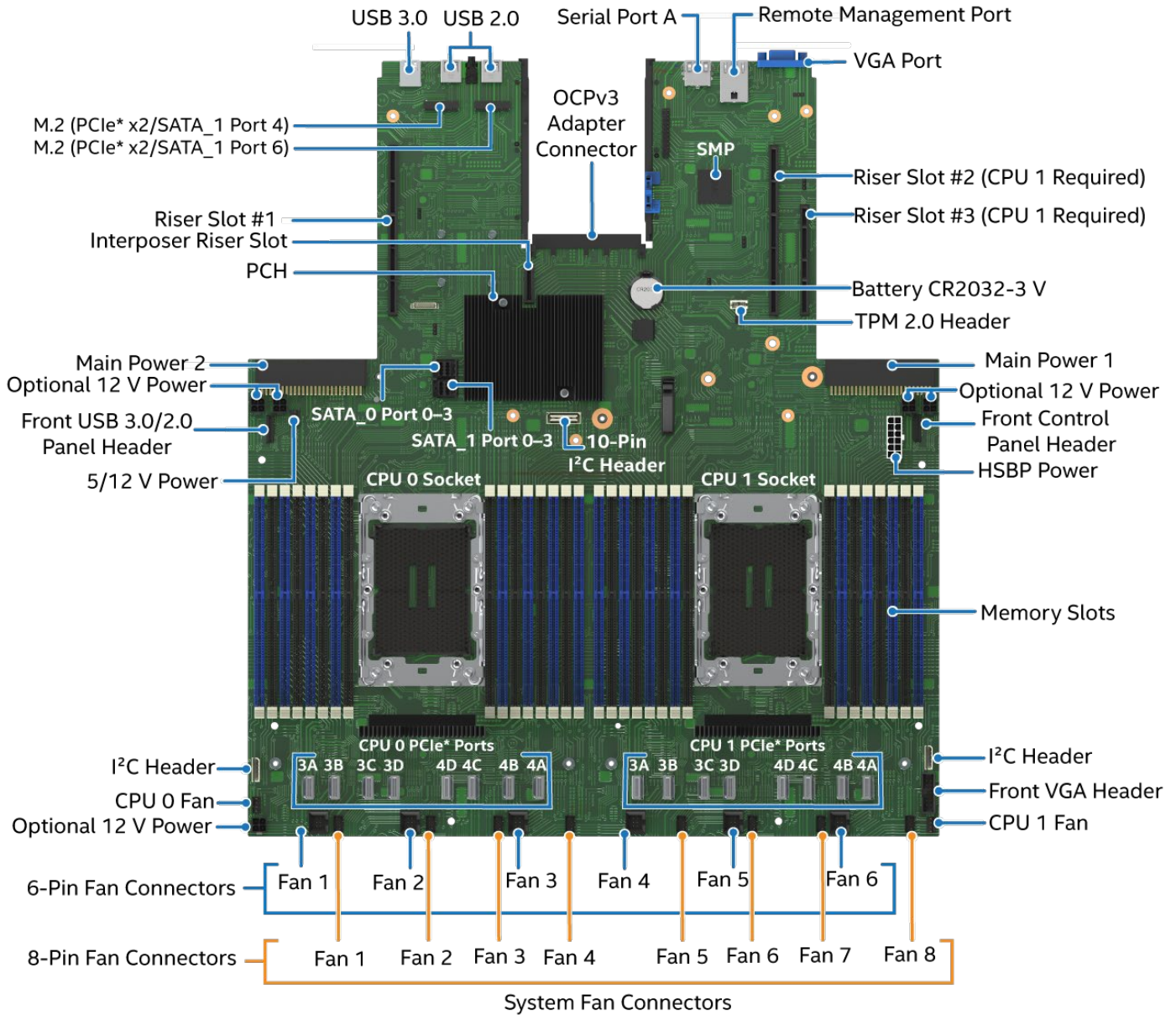


Figure 13. Intel® Server Board M50FCP2SBSTD Architectural Block Diagram

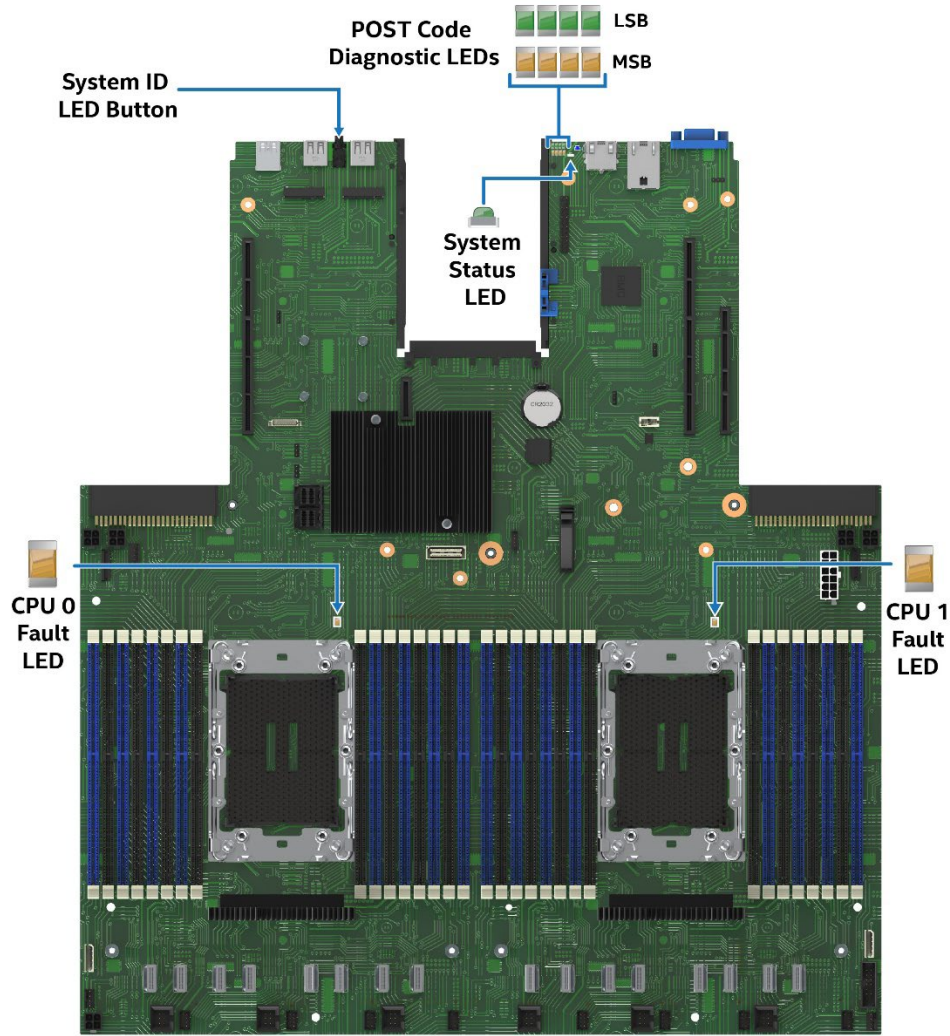
Figure 14 provides an overview of the server board, identifying key feature and component locations.



Ref #: FCPI0245

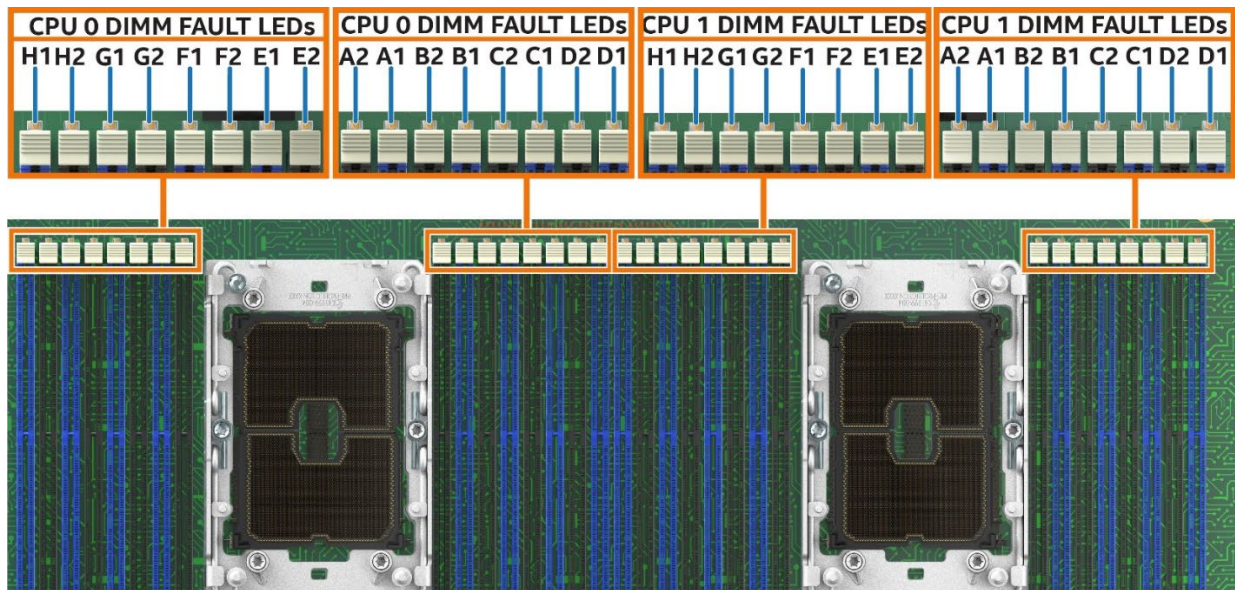
**Figure 14. Intel® Server Board M50FCP2SBSTD Component / Feature Identification**

The server board includes LEDs to identify system status and/or indicate a component fault. The following two figures identify Intel® Light-Guided Diagnostic LEDs on the server board. For more information about Intel® Light-Guided Diagnostics, see [Chapter 8](#).



Ref #: FCP10232

Figure 15. Intel® Light-Guided Diagnostics – LED Identification



Ref #: FCP10170

Figure 16. Intel® Light-Guided Diagnostics – Memory Fault LEDs

The server board includes several jumper blocks that can be used to configure, protect, or recover specific features of the server board. See the *Intel® Server Board M50FCP2SBSTD Technical Product Specification (TPS)* for more information.

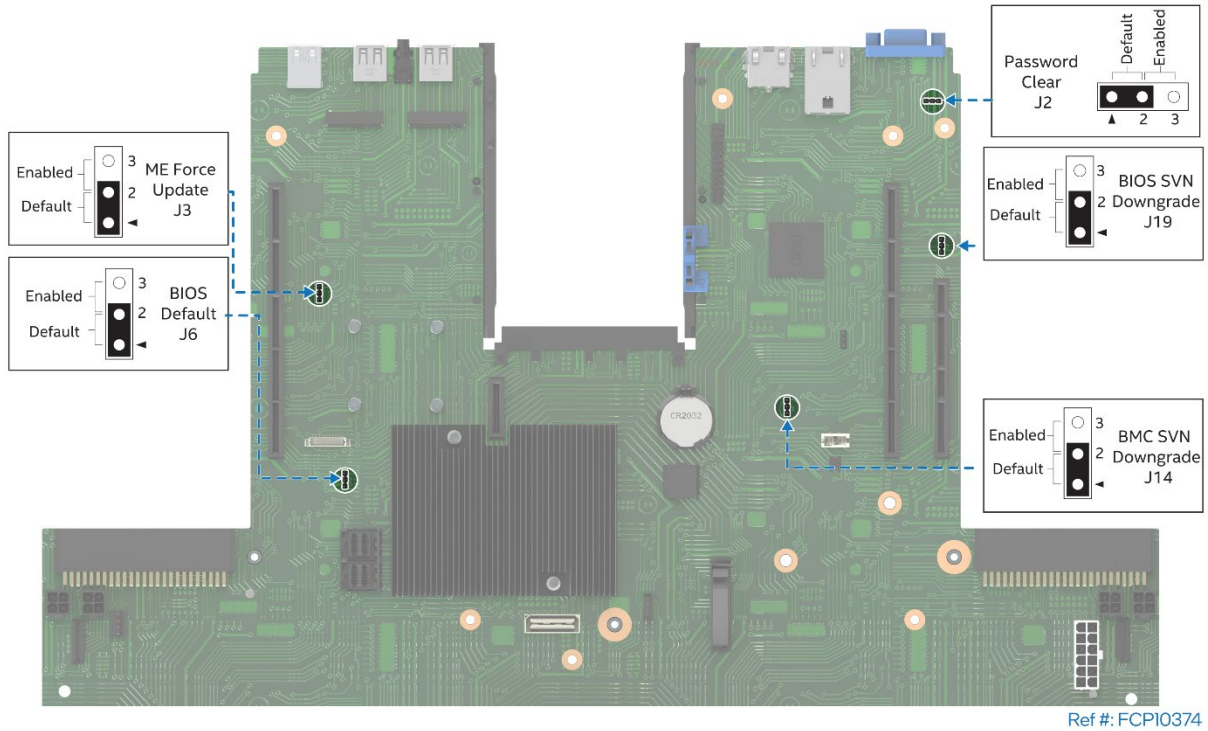


Figure 17. System Configuration and Recovery Jumpers

## 2.5 System Dimensional and Labeling Options

The following subsections provide chassis dimensional data for all system configurations.

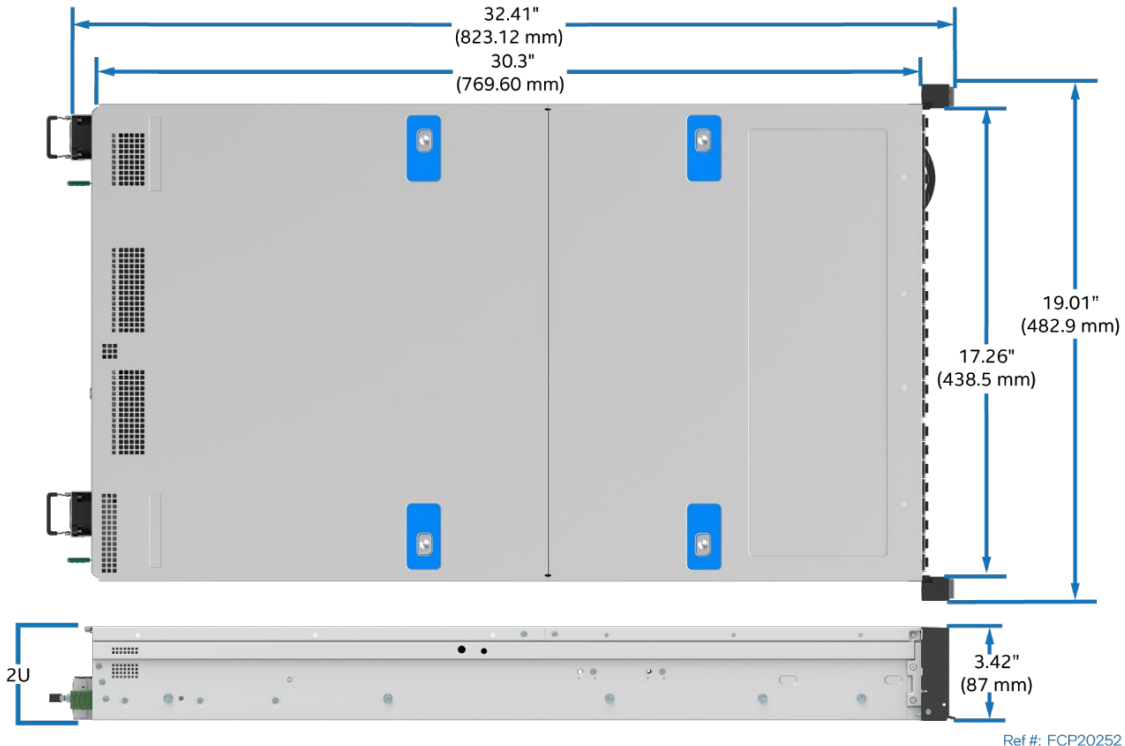
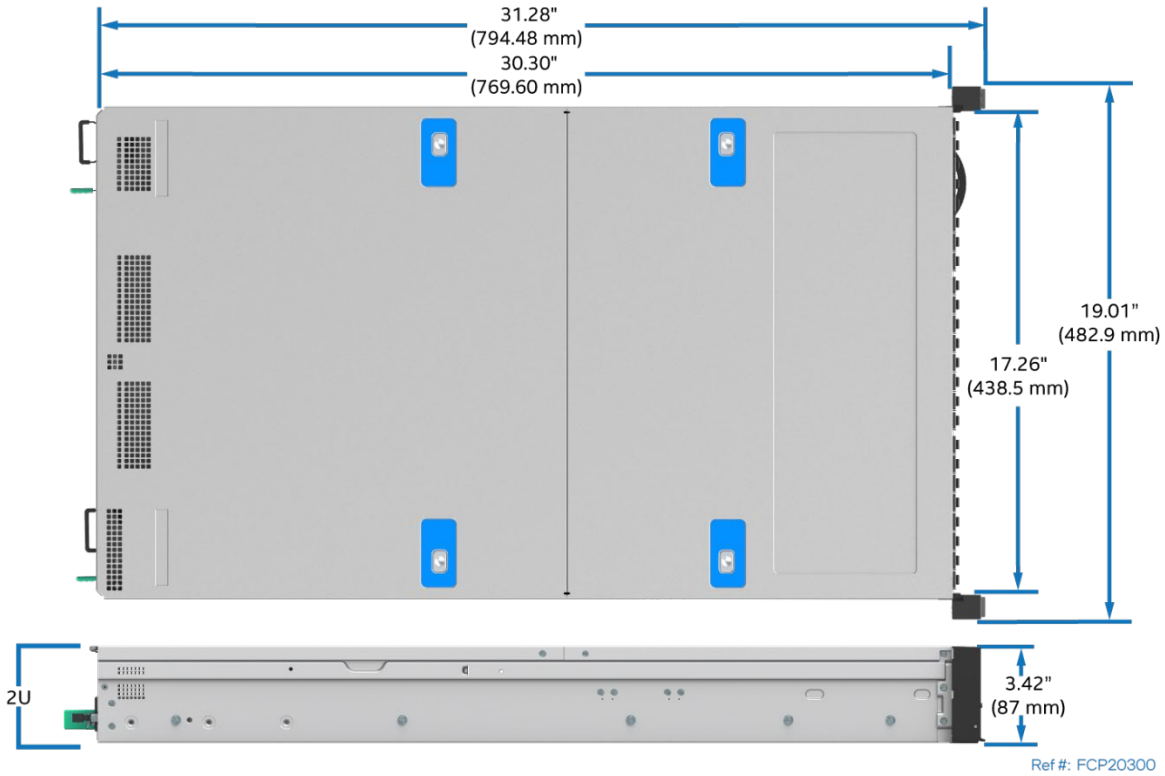
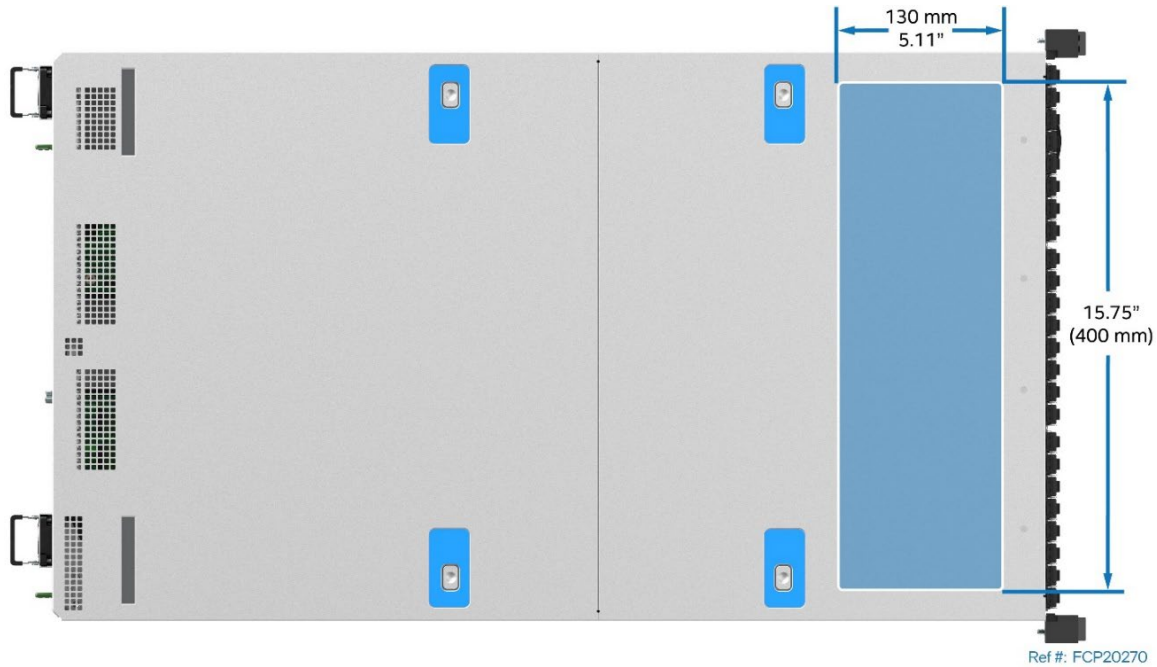


Figure 18. System Dimensions with 2100 Watt Power Supply Option



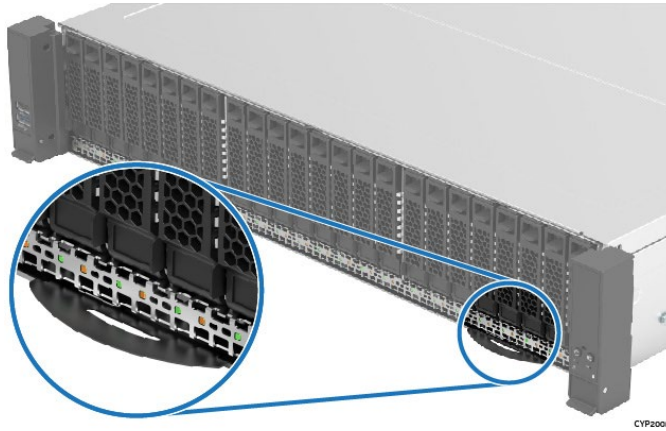
**Figure 19. System Dimensions with 1300 Watt or 1600 Watt Power Supply Options**

The chassis includes an embossed system label target over the front drive bay. A label that is placed within the embossed area is protected from being scratched as the system slides in or out of a system rack.



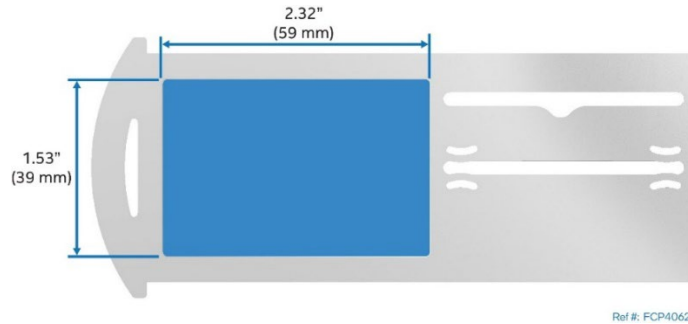
**Figure 20. Label Emboss Dimensions**

An additional system label can be placed on a mylar pull-out tab that extends out approximately 61 mm from the chassis front (See Figure 21). The pull-out tab can be useful to obtain system information while the system is installed within a system rack.



**Figure 21. Pull-Out Tab Location**

The following figure shows pull-out tab label emboss dimensions.



**Figure 22. Pull-Out Tab Label Emboss Dimensions**

## 2.6 System Top Cover

The system top cover consists of two panels; one over the front half of the system and one over the back half of the system. To maintain system thermals, both top cover panels must be installed when the system is operational. Removal of both top cover panels is necessary when installing or replacing any system component integrated within the server chassis.

The top cover panels support the option of securing them to the chassis using a set of four screws as shown in [Figure 23](#).

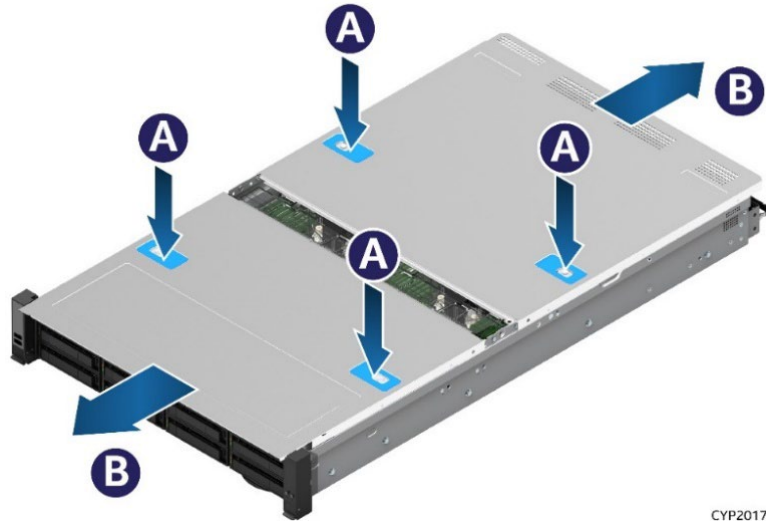


**Figure 23. Top System Cover Panels Shipping Screws**

Ensure that the four screws are removed before attempting to remove the top panel covers from the system.

**Shipping Note:** When transporting the server system, Intel recommends installing the four top cover screws before shipping.

Each top cover panel includes a set of two latches to lock them in place.



CYP20172

**Figure 24. System Top Cover Removal**

To remove a top cover panel, push down on both the left and right latch buttons of the given top panel (see letter A), and slide the top cover panel towards the front (front panel) or back (back panel) of the chassis (see Letter B).

When installing a top cover panel, align and set the top cover panel on the chassis (see Letter A in the following figure), and slide it inwards until it locks in place.



CYP20183

**Figure 25. System Top Cover Installation**

For more information, see the *Intel® Server System M50FCP2UR System Integration and Service Guide*.



## 2.7 System Cable Routing Channels

The system includes a system fan assembly module that holds the system fans. The system fan assembly module must be removed from the system in order to route internal cables between the back and front of the system, and between the onboard PCIe MCIO connectors on the server board to the backplanes.

All internal cables routed between the back and the front of the system, must use the cable channels located along the right and left chassis sidewalls. (See [Figure 26](#)).

Cables connected between the onboard PCIe MCIO connectors and the backplanes behind the front drive bay are routed underneath the system fan assembly and through the included cable management clips. (See [Figure 26](#)).

No cables should be routed between the memory modules and processors

---

**Note:** The system fan assembly must be removed from the chassis before routing any internal cables.

---

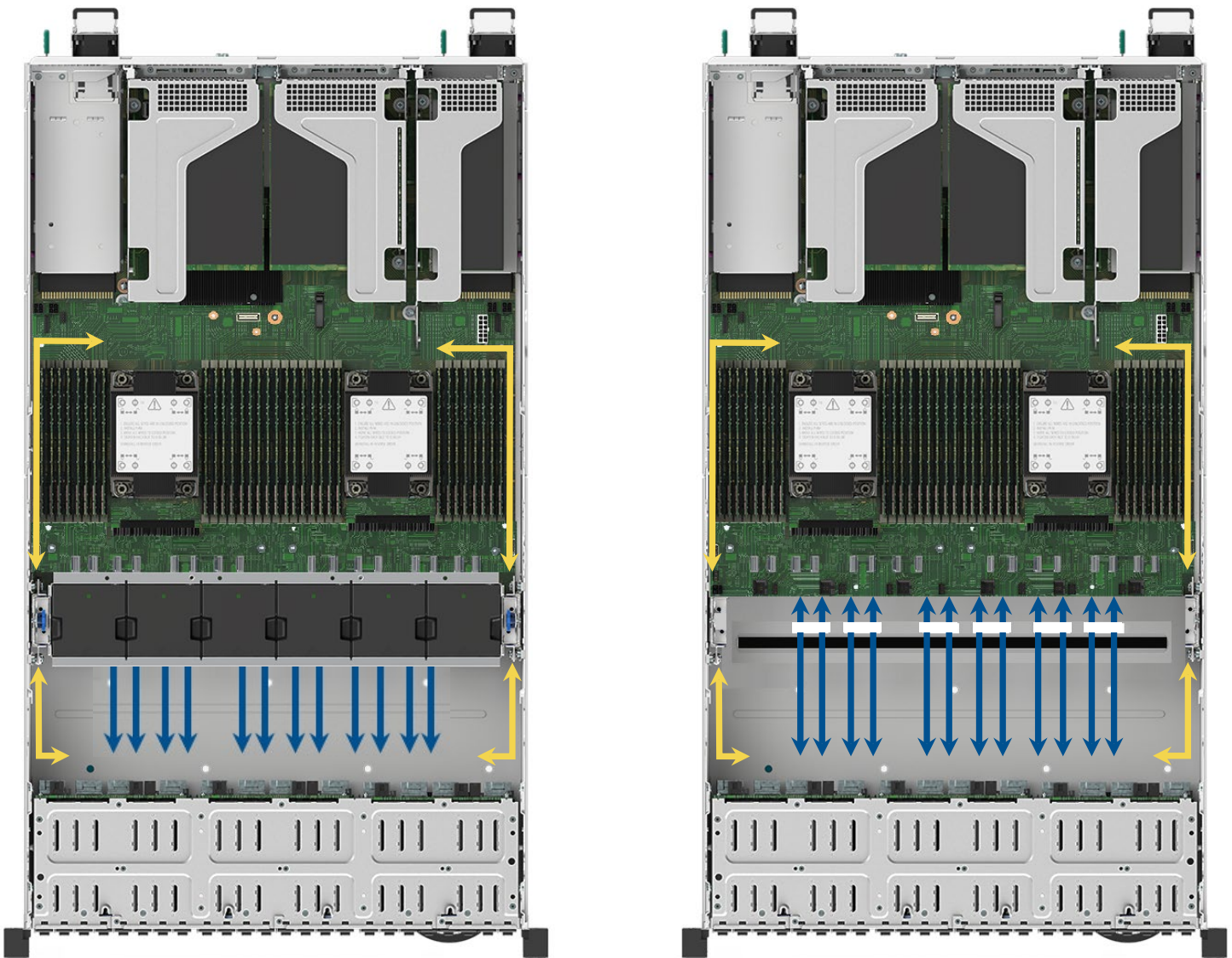
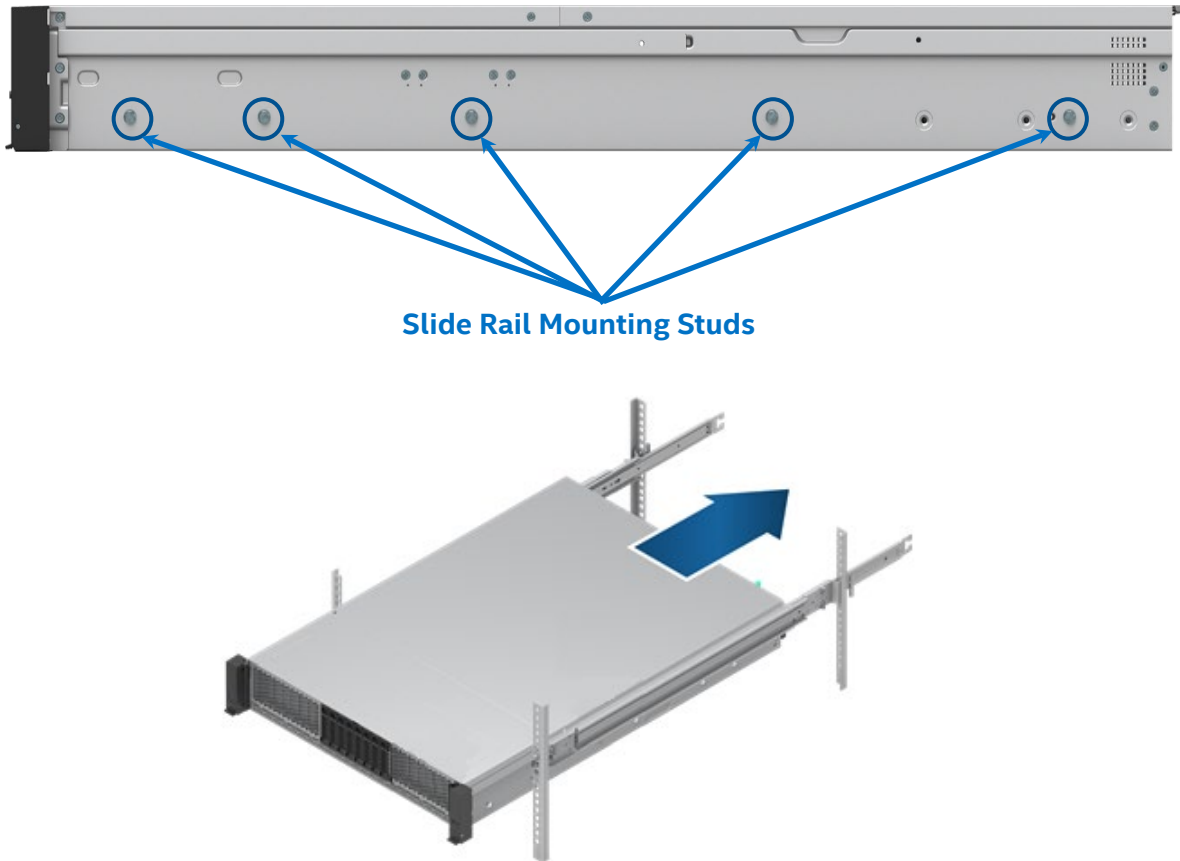


Figure 26. System Cable Routing Channels

## 2.8 Rack and Cabinet Mounting Kit

The Intel® Server System M50FCP2UR is a 2U rack mount server system that requires that a rail kit be attached to the chassis sidewalls to install it within a 4-post server rack or cabinet. Rails are attached to the server by placing them over and sliding them onto a set of mounting studs located on each side of the server chassis.



### CYPHALFEXTRAIL – Value rack mount rail kit

- 1U, 2U compatible
- Tool-less chassis attachment
- Tools required to attach rails to rack
- Rack installation front and rear post distance adjustment from 660 mm to 838 mm
- 560 mm travel distance
- Half extension from rack
- Support for front cover removal and fan replacement
- 31 kg (68.34 lbs.) maximum support weight

### CYPFULLEXTRAIL – Premium rail kit with cable management arm (CMA) support

- 1U, 2U compatible
- Tool-less installation
- Rack installation front and rear post distance adjustment from 623 mm ~ 942 mm
- 820 mm travel distance
- Full extension from rack
- 31 Kg (68.34 lbs.) maximum supported weight
- Support for CMA AXXCMA2

### AXXCMA2 – CMA (supports CYPFULLEXTRAIL only)

**Caution:** Exceeding the specified maximum weight limit of a given rail kit or misalignment of the server in the rack may result in failure of the rack rails, damaging the system, or causing personal injury. Using two people or the use of a mechanical assist tool to align and install the server into the rack or cabinet is highly recommended.

**Shipping Disclaimer:** Available rail kits are not designed to support shipment of the server system while installed in a rack or cabinet. If choosing to do so, Intel strongly recommends that appropriate shock and vibration testing of the full rack configuration be performed before shipment.

Intel does not perform testing that exposes the racked system to the stresses of a transport environment using the complex combination of third-party racks, cabinets, and custom packaging options.

Intel highly recommends that systems have six shipping screws (not included) be installed to the system back panel (see [Figure 27](#)). These screws provide the chassis with additional support by reducing possible chassis flex and minimizing possible sag of the base plate. Installed screws should meet the following specifications: flat head, 6–32 thread, 3.75 mm length.



Ref #: FCP20100

**Figure 27. Rear Panel Shipping Screw Holes**

## 2.9 System Level Environmental Limits

The following table lists the system level operating and non-operating environmental limits.

**Table 3. System Environmental Limits Summary**

Parameter		Limits			
Temperature	Operating	ASHRAE Class A2 – Continuous Operation. 10–35 °C (50–95 °F) with the maximum rate of change not to exceed 10 °C per hour. <sup>1</sup> ASHRAE Class A3 – Includes operation up to 40 °C for up to 900 hrs. per year. <sup>1</sup> ASHRAE Class A4 – Includes operation up to 45 °C for up to 90 hrs. per year. <sup>1</sup>			
	Non-operating	-40 through 70 °C (-40 through 158 °F)			
Altitude	Operating	Support operation up to 3050 m (10,006 feet) with ASHRAE class de-ratings.			
Humidity	Shipping	50% to 90%, non-condensing with a maximum wet bulb of 28 °C (at temperatures 25–35 °C)			
Shock	Operating	Half sine, 2 g, 11 msec			
	Unpackaged	Trapezoidal, 25 g, velocity change is based on packaged weight			
	Packaged	ISTA (International Safe Transit Association) Test Procedure 3A 2008			
Vibration	Unpackaged	5–500 Hz, 2.20 g RMS random			
	Packaged	ISTA (International Safe Transit Association) Test Procedure 3A 2008			
AC-DC	Voltage	90–140 V (Rated 100–127 V) and 180–264 V (rated 200–240 V)			
	Frequency	47–63 Hz (rated 50/60 Hz)			
	Source interrupt	No loss of data for power line drop-out of 12 msec			
	Surge non-operating and operating	Unidirectional			
	Line to earth only	AC Leads	2.0 kV		
ESD	Air discharged	12.0 kV			
	Contact discharge	8.0 kV			
Acoustics Sound Power Measured	Power	<300 W	≥300 W	≥600 W	≥1000 W
	Servers/rack mount Sound power level	7.0 BA	7.0 BA	7.0 BA	7.0 BA

**Note:** (1) For system configuration requirements and limitations, see [Appendix D](#) in this document or an online power calculator tool accessible at the following Intel web site: <https://servertools.intel.com/tools/power-calculator/>.

**Disclaimer:** Intel server boards contain and support several high-density VLSI and power delivery components that need adequate airflow to cool and remain within their thermal operating limits. Through its own chassis development and testing, Intel ensures that when an Intel server board and an Intel server chassis are used together, the fully integrated system meets the thermal requirements of these components. Intel cannot be held responsible if components fail or the server board does not operate correctly when published operating and non-operating limits are exceeded.

## 2.10 System Packaging

The original Intel packaging is designed to provide protection for a fully configured system and tested to meet International Safe Transit Association (ISTA) Test Procedure 3A (2008). The packaging is designed to be reused after integration of system components has been completed and the system is to be shipped to its final destination.

The original packaging includes two layers of boxes: an inner box and the outer shipping box. The packaging also includes various protective inner packaging components.

The boxes and packaging components are designed to function together as a protective packaging system. When reused, the original packaging material must be free of any damage sustained from previous use. In addition, all inner packaging components must be reinstalled in the proper location to ensure adequate protection of the system for subsequent shipment.

---

**Note:** The design of the inner packaging components does not prevent improper placement within the packaging assembly. Only one correct packaging assembly allows the package to meet the ISTA Test Procedure 3A (2008) limits.

For complete packaging assembly instructions, see the *Intel® Server System M50FCP2UR System Integration and Service Guide*.

Failure to follow the specified packaging assembly instructions may result in damage to the system during shipment.

---

The 2U shipping box dimensions are:

- External dimensions for the outer shipping box
  - Length: 39.13" (994 mm)
  - Width: 23.31" (592 mm)
  - Height: 11.81" (300 mm)
- Internal dimensions for the Inner box
  - Length: 11.96" (964 mm)
  - Width: 22.13" (562 mm)
  - Height: 9.53" (242 mm)

---

**Note:** See the *Intel® Server M50FCP2UR Family Configuration Guide* for product weight information associated with each supported system configuration.

---

### 3. System Power

The Intel® Server System M50FCP2UR supports the following power supply options:

- AC 1300 W (80 PLUS Titanium\*)
- AC 1600 W (80 PLUS Titanium\*)
- AC 2100 W (80 PLUS Platinum\*)

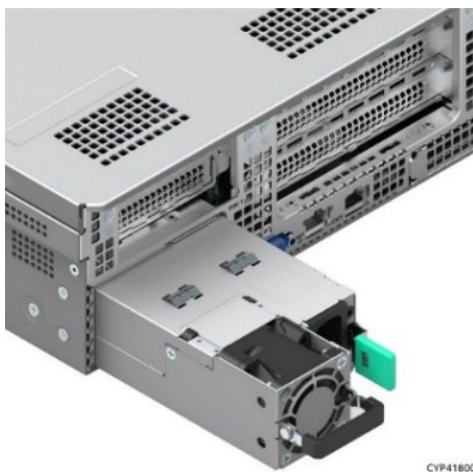
Power supplies are modular and are installed from the back of the system where two power supply bays are located, one on each side of the chassis. See [Figure 28](#). No tools are required to service a power supply.

#### Notes:

- In dual power supply configurations, both power supplies must be identical. A system configured with two different power supply options is not supported. An unsupported power supply configuration will not provide power supply redundancy and results in the system generating multiple errors to the system event log.
- Selecting the appropriate power supply option is dependent on the chosen system configuration and the required power to support it. To determine the power requirements of a chosen system configuration, Intel recommends using its online power calculator tool, which is accessible at the following Intel web site: <https://servertools.intel.com/tools/power-calculator/>.



**Figure 28. Power Supply Module Identification**



**Figure 29. 2100 W Power Supply Module Partially Out of Chassis**

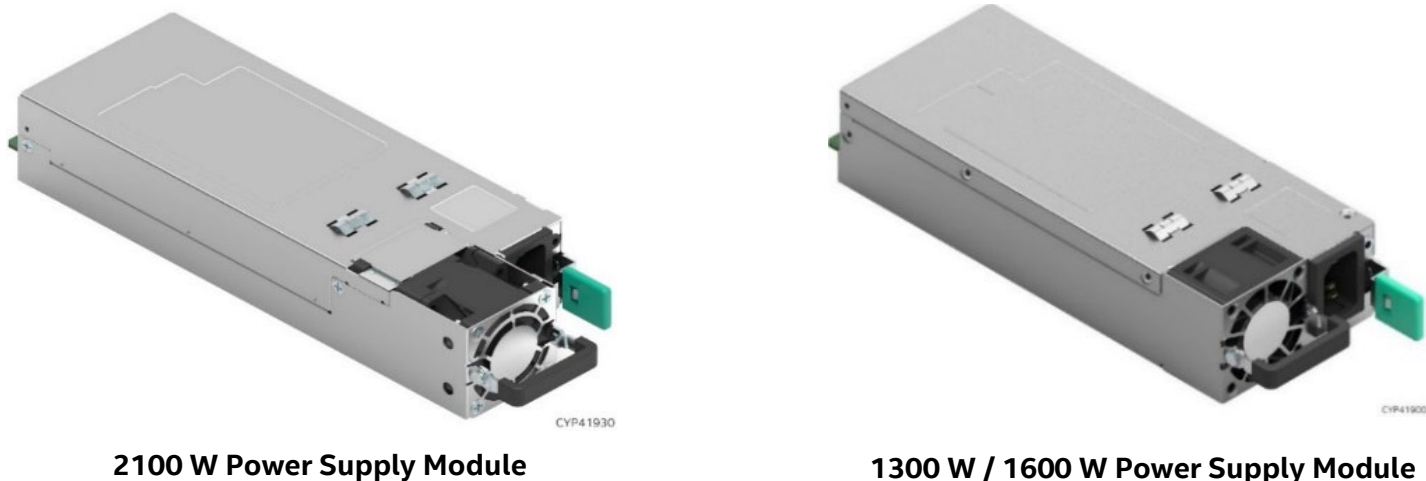


Figure 30. Power Supply Modules

### 3.1 Power Supply Configurations

Embedded platform management automatically determines and configures the power supply configuration based on the number of functional power supplies detected, and the total power draw of the system.

The system supports the following power configurations:

- **1+0** – One functional power supply detected – **no power redundancy**. Supported if the power requirement of the system stays below the maximum power limit of the one functional power supply.
- **1+1** – Two functional power supplies detected – **redundant power with hot replacement supported**. Configured if the power requirement of the system stays below the maximum power limit of one power supply.
- **2+0** – Two functional power supplies installed – **combined power, no redundancy**. Configured if the power requirement of the system is greater than the maximum power limit of a single power supply.

#### 3.1.1 Single Power Supply (1+0) Power Configuration

Platform management will set the system power configuration to 1 + 0 (non-Redundant) when it detects that the system has only one power supply installed, or when only one of two power supplies is functional.

With a single functional power supply, the system has no power redundancy and the total available power to the system is limited to the maximum power capacity of the power supply. Should the system power draw exceed the power limits of the power supply, server management will enable throttling which limits I/O operations to system memory, processors, or both. System performance is impacted until server management restores I/O operations to normal levels. Should the system power draw exceed the power limits of the power supply with throttling enabled, then server management will shut down the system.

A power supply event that shuts down the system generates multiple events and errors that are registered into the system event log (SEL). The state of the System Status LED on the front panel changes to solid amber, denoting that a critical system event has occurred.

#### 3.1.2 Dual Power Supply 1+1 Power Configuration

Platform management will set the system power configuration to 1 + 1 (Redundant Power) if it detects two functional power supplies and the total power draw of the given system configuration is less than or equal to the power limit of a single power supply. In a redundant power configuration, if one power supply fails, the backup or secondary power supply will automatically engage and provide the necessary power to maintain optimal system operation.

With a power supply failure, the BMC generates several events that are registered to the system event log and changes the system power configuration to 1 + 0 (non-redundant) (see section 3.1.1) until the failed power supply is replaced. In addition, the System Status LED on the front panel will change to Blinking Green, denoting a degraded but operational system state.

Power supplies are hot-replaceable, allowing a failed power supply to be replaced without having to first power down the system. After replacing a failed power supply, platform management will automatically change the power configuration to either 1 + 1 or 2 + 0 depending on the total system power draw at the time the new power supply was detected. The System Status LED state changes back to solid green, denoting the system is operating in a fault free normal state.

### 3.1.3 Dual Power Supply 2+0 Power Configuration

Platform management will set the system power configuration to 2 + 0 (Combined Power) if it detects two functional power supplies and the total power draw of the given system configuration exceeds the limits of one power supply. In this configuration, power from both power supplies will be used to supply the system with power to support an optimal system operation.

Combined power does not mean that twice as much power is available to the system. Enough power will be pulled from both power supplies to support an optimal system operation.

In a 2 + 0 power configuration, if a power supply fails, platform management will initiate throttling, which limits system I/O operations to system memory, processors, or both. Throttling is only effective if the total system power draw is reduced enough to allow the system to operate with the single remaining power supply. System performance will be degraded if throttling is enabled.

When platform management detects a power supply has shut down, several system error and status change events are logged to the system event log. The System Status LED changes to Blinking Green, denoting a degraded but operational system state. In addition, system power changes to a nonredundant 1 + 0 configuration (see previous section) until the failed power supply is replaced.

A failed power supply is hot-swappable if the system is still operational with the remaining power supply. The failed power supply can be replaced without having to first power down the system. After replacing a failed power supply and with the system operating normally, platform management automatically disables throttling, and changes the power configuration to either 1 + 1 or 2 + 0 depending on the total system power draw.

Should throttling fail to reduce power enough for the system to be supported by a single power supply, then the system will shut down. Several system events will be logged to the system event log, and the state of the System Status LED on the front panel changes to solid amber, denoting that a critical system event has occurred.

## 3.2 Intel® Power Calculator Tool

For system integrators that would like to determine the system power draw and heat dissipation for a specific system configuration, Intel makes available an on-line power calculator tool accessible at the following Intel web site:

<https://servertools.intel.com/tools/power-calculator/>

## 3.3 Closed Loop System Throttling (CLST)

Closed Loop System Throttling (CLST) is supported. CLST prevents the system from crashing if a power supply module is overloaded or overheats. If the system power reaches a pre-programmed power limit, CLST throttles system memory and/or processors to reduce power. System performance is degraded if throttling occurs.



### 3.4 Smart Ride Through (SmaRT) Throttling

Smart Ride Through (SmaRT) throttling is supported. SmaRT increases the reliability of a system operating in a heavy power load condition and to remain operational during an AC line dropout event.

When AC voltage is too low, a fast AC loss detection circuit inside each installed power supply asserts an SMBALERT# signal to initiate a throttle condition in the system. System throttling reduces the bandwidth to both system memory and processors that, in turn, reduces the power load during the AC line drop out event.

### 3.5 Power Supply Cold Redundancy

In dual power supply 1 + 1 redundant power configurations, by default, the BMC enables support for Cold Redundancy mode. Cold redundancy can put the redundant power supply into a low power (almost off) standby state. This operation is done to save energy at system idle while still being able to turn back on fast enough (within 100 µsec) in case of a power supply failure to keep the system operating normally.

In Cold Redundancy mode, the BMC assigns and identifies each power supply as either “Active” or “Cold Standby”. The Active power supply provides the system with power. The cold standby power supply is placed in a low power standby state and is a backup to the active power supply in case of failure.

To support highest long-term reliability of each power supply, the BMC schedules a rolling reconfiguration. Installed power supplies alternate between being the “Active” and the “Cold Standby” that allows for equal loading over the lifetime of each power supply.

The BMC uses the `Cold_Redundancy_Config` command to both set each power supply’s role in cold redundancy and to enable/disable cold redundancy.

The following events trigger a reconfiguration of the power supplies using the `Cold_Redundancy_config` command:

- Source power ON
- PSON power ON
- Power supply failure
- Power supply inserted into system

### 3.6 Power Supply Specification Overview

The Intel® Server System M50FCP12UR supports the following power supply options:

- AC 1300 W (80 PLUS Titanium\*)
- AC 1600 W (80 PLUS Titanium\*)
- AC 2100 W (80 PLUS Platinum\*)

AC power supplies are auto-ranging and power factor corrected.

The following subsections provide an overview of select power supply features and functions.

---

**Note:** Full power supply specification documents are available upon request. Power supply specification documents are classified as Intel Confidential and requires a signed NDA with Intel before being made available.

---


#### 3.6.1 Power Supply Module Efficiency

Each power supply option is rated to meet specific power efficiency limits based on their 80 PLUS power efficiency rating: Titanium or Platinum.


The following tables define the required minimum power efficiency levels based on their 80 PLUS efficiency rating at specified power load conditions: 100%, 50%, 20%, and 10%.

The AC power supply efficiency is tested over an AC input voltage range of 115–220 VAC.

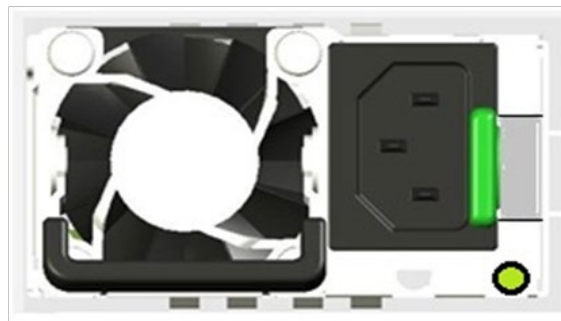
**Table 4. 1300 W and 1600 W AC Power Supply Option Efficiency (80 PLUS\* Titanium)**

	Loading	100% of Maximum	50% of Maximum	20% of Maximum	10% of Maximum
	Minimum Efficiency		91%	96%	94%

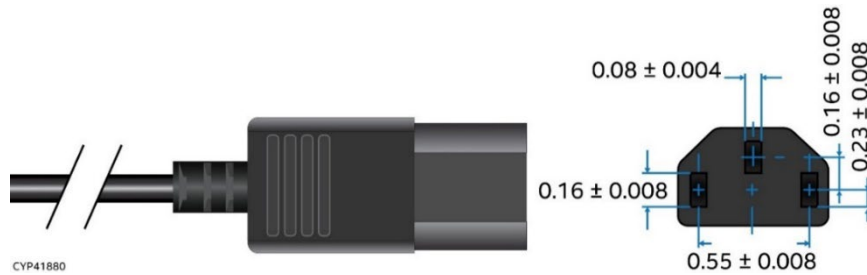
**Table 5. 2100 W AC Power Supply Option Efficiency (80 PLUS\* Platinum)**

	Loading	100% of Maximum	50% of Maximum	20% of Maximum	10% of Maximum
	Minimum Efficiency		91%	94%	90%

### 3.6.2 AC Power Cord Specifications



**Figure 31. AC Power Cable Connector**



**Figure 32. AC Power Cord Specification**

The AC power cord used must meet the specification requirements listed in the following table.

**Table 6. AC Power Cord Specifications**

Item	Description
Cable Type	SJT
Wire Size	14 AWG
Temperature Rating	105 °C
Amperage Rating	10 A at 240 V
Voltage Rating	240 VAC

## 3.7 AC Power Supply Features

The following sections describe features supported by the AC power supply options.

### 3.7.1 Power Supply Status LED

A single bi-color LED indicates power supply status. The operational states of this bi-color LED are defined in the following table.

**Table 7. LED Indicators**

LED State	Power Supply Condition
<b>Solid green</b>	Output ON and OK.
<b>Off</b>	No source power to all power supplies.
<b>1 Hz blinking green</b>	Source power present/only 12 VSB on (PS off) or PS in cold redundant state.
<b>Solid amber</b>	Source power cord unplugged or source power lost; with a second power supply in parallel still with AC input power. Or power supply critical event causing a shutdown; failure, over current protection, over voltage protection, fan fail.
<b>1 Hz blinking amber</b>	Power supply warning events where the power supply continues to operate; high temp, high power, high current, slow fan.
<b>2 Hz blinking green</b>	Power supply firmware updating.

### 3.7.2 Protection Circuits

Each installed power supply module includes several protection circuits that shut down the power supply in the event that a defined operating threshold is exceeded.

#### 3.7.2.1 Over Current Protection

Each installed power supply is protected against excess current. The power supply unit shuts down for a specific time period after crossing current thresholds. A power supply that is shut down due to an exceeded protection circuit threshold can be reset by removing source power for 15 seconds.

**Table 8. Over Current Protection for 1300 W Power Supplies**

Output Voltage	Input Voltage Range	Over Current Limits	Over Current Protection Delay
<b>+12 V</b>	180–264 VAC	132 A minimum / 138 A maximum	50 msec minimum / 200 msec maximum
		152 A minimum / 160 A maximum	5 msec minimum / 20 msec maximum
	90–140 VAC	72 A minimum / 77 A maximum	50 msec minimum / 200 msec maximum
		103 A minimum / 107 A maximum	5 msec minimum / 20 msec maximum
<b>12 VSB</b>	90–264 VAC	2.5 A minimum / 3.5 A maximum	5 msec minimum / 20 msec maximum

**Table 9. Over Current Protection for 1600 W Power Supplies**

Output Voltage	Input Voltage Range	Over Current Limits	Over Current Protection Delay
<b>+12 V</b>	180–264 VAC	155 A minimum / 165 A maximum	30 msec minimum / 100 msec maximum
<b>12 VSB</b>	90–264 VAC	3.6 A minimum / 4 A maximum	1 msec minimum / 100 msec maximum

**Table 10. Over Current Protection for 2100 W Power Supplies**

Output Voltage	Input Voltage Range	Over Current Limits	Over Current Protection Delay
<b>+12 V</b>	180–264 VAC	252 A minimum / 258 A maximum	50 msec minimum / 200 msec maximum
		269 A minimum / 277 A maximum	5 msec minimum / 20 msec maximum
<b>12 VSB</b>	90–264 VAC	3.6 A minimum / 4 A maximum	10 msec minimum / 20 msec maximum

**Table 11. Over Voltage Protection (OVP) Limits for 1300 W, 1600 W, and 2100 W Power Supplies**

Output Voltage	Minimum (V)	Maximum (V)
+12 V	13.5	14.5
+12 VSB	13.5	14.5

### 3.7.2.2 Over Temperature Protection (OTP)

Each installed power supply is protected against over temperature conditions caused by loss of fan cooling or excessive ambient temperature. The power supply unit shuts down during an OTP condition. Once the power supply temperature drops to within specified limits, the power supply restores power automatically.

---

**Note:** The 12 VSB always remains on while the power supply is connected to the power source.

---

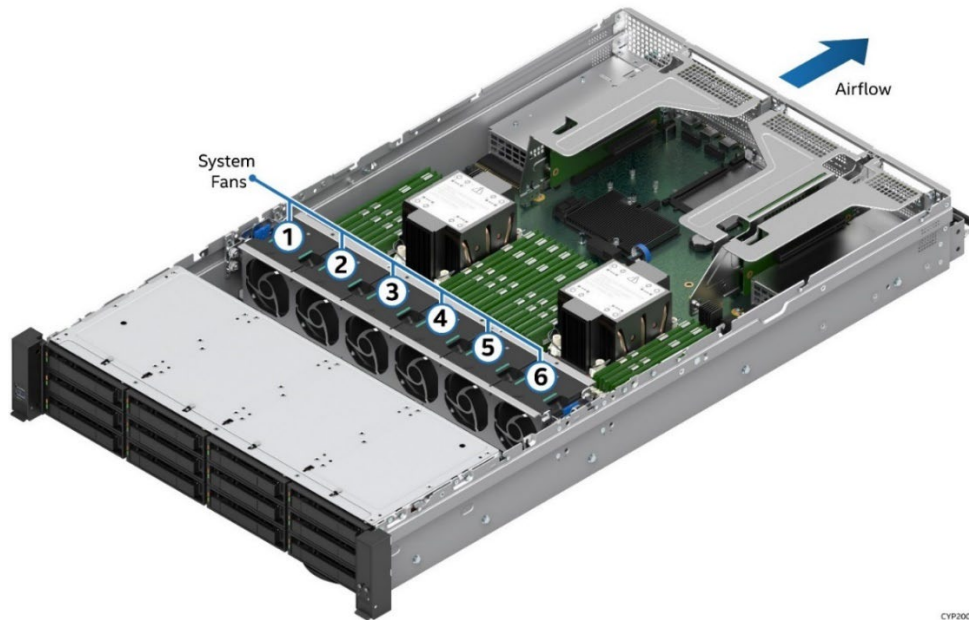
## 4. Thermal Management

The embedded platform management subsystem is responsible for keeping the system operating reliably and with best performance. The integrated baseboard management controller (BMC) embedded within the Aspeed® AST2600 Advanced PCIe® Graphics and Remote Management processor is the component most responsible for determining and implementing system actions under varying environmental and operational conditions.

Thermal management is critical to system performance and long-term reliability. The system is designed to operate at external ambient air temperatures ranging from 10 °C to 35 °C. The system must maintain a steady airflow through the system to expel all hot air generated within it.

Using six system fans, an embedded fan within each installed power supply, and other system components, the system pulls cool air in from the front, channels it over and through several high heat generating components and areas within the chassis, and then pushes the hot air out the back. This operation is intended to prevent the components from overheating, allowing the system to operate optimally.

The system supports fan redundancy. Should a single fan fail, the system will keep internal system temperatures below critical thermal limits. See [Appendix D](#) for thermal configuration limits for fan redundancy support. Thermal redundancy is lost if more than one fan fails



**Figure 33. System Airflow and Fan Identification**

The following tables provide airflow data associated with the Intel® Server System M50FCP2UR. This data is provided for reference purposes only. The data was derived from actual wind tunnel test methods and measurements using fully configured (worst case) system configurations. Different system configurations may produce slightly different data results. In addition, the cubic feet per minute (CFM) data provided using server management utilities that use platform sensor data may vary slightly from the data listed in the tables.

**Table 12. System Volumetric Airflow – M50FCP2UR208**

System Fan	Power Supply Fan	Total Airflow (CFM)
100%	Auto	253
100%	100%	258
55%	Auto	141

**Table 13. System Volumetric Airflow – 16 x 2.5" Front Drive Bay Configuration**

System Fan	Power Supply Fan	Total Airflow (CFM)
100%	Auto	250
100%	100%	255
55%	Auto	136

**Table 14. System Volumetric Airflow – 24 x 2.5" Front Drive Bay Configuration**

System Fan	Power Supply Fan	Total Airflow (CFM)
100%	Auto	204
100%	100%	208
55%	Auto	110

**Table 15. System Volumetric Airflow – M50FCP2UR312**

System Fan	Power Supply Fan	Total Airflow (CFM)
100%	Auto	116
100%	100%	120
55%	Auto	53

## 4.1 Thermal Operation and Configuration Requirements

Chassis design and several system components within the system are designed to provide the system with the appropriate air flow necessary to keep the system operating with best performance. These include:

- Six managed 60-mm system fans
- Fans integrated into each installed power supply module
- Air duct
- Appropriate processor heat sinks
- Populated drive carriers/rails
- Populated memory slots
- Proper cable routing

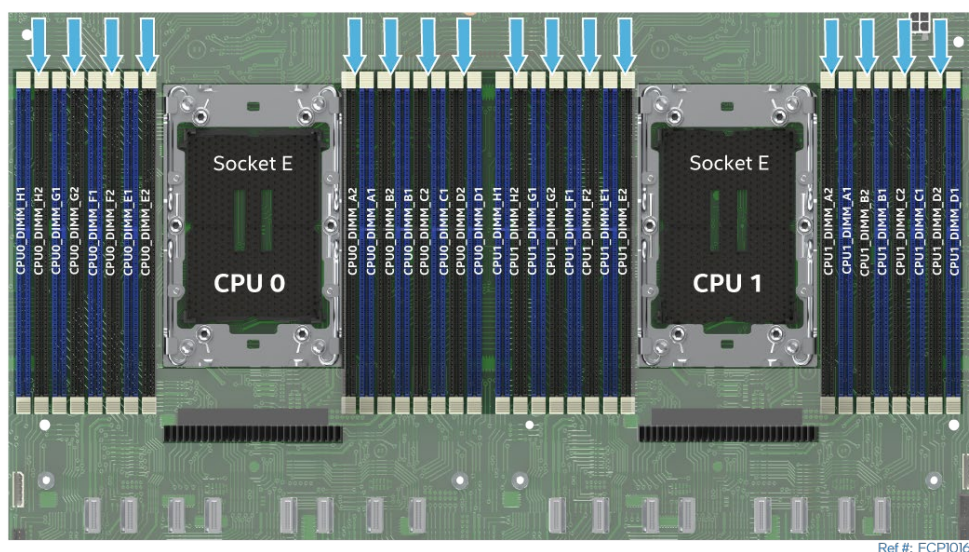
To keep the system operating within supported thermal limits, the system must meet the following operating and configuration guidelines:

- The system is designed to sustain operations at an ambient temperature of up to 35 °C (ASHRAE Class A2) with short term excursion based operation up to 45 °C (ASHRAE Class A4).
- The system is designed to support long term reliability targets when operated at an external ambient temperature of up to 35 °C (ASHRAE A2). See [Table 3](#) for extended temperature support details.
- The system can operate up to 40 °C (ASHRAE Class A3) for up to 900 hours per year.
- The system can operate up to 45 °C (ASHRAE Class A4) for up to 90 hours per year.
- No long term system reliability impact when operating at the extended temperature range within the documented limits.
- System performance may be impacted when operating within the extended operating temperature range.

Specific configuration requirements and limitations are documented in [Appendix D](#). The requirements and limitations are also in an online power calculator tool accessible at the following Intel web site:

<https://servertools.intel.com/tools/power-calculator/>

- Single processor configurations must install the processor and heat sink to the CPU 0 processor socket. Using the CPU 1 processor socket for single processor configurations is not supported.
- All front drive bays must be populated with either an SSD or supplied drive blank.
- See [Section 5.1.1](#) to determine best placement of PCIe add-in cards.
- All internal cables routed between the back of the system and the front must be routed using cables channels along both sidewalls. See [Figure 26](#).
- All internal cables routed between any of the onboard PCIe MCIO connectors and the backplanes must be routed beneath the system fan assembly module. See [Figure 26](#).
- All black memory slots must be populated with a memory module or factory installed DIMM blank. (See [Figure 34](#)). All system configurations ship from Intel with DIMM blanks preinstalled. Preinstalled DIMM blanks should only be removed when installing a memory module in its place.



**Figure 34. System Memory Modules / DIMM Blanks Configuration**

## 4.2 Thermal Management Overview

To maintain the necessary airflow within the system, all previously listed components and top cover need to be properly installed. For optimal system performance, the external ambient temperature should remain below 35 °C and all system fans should be operational.

The system is designed for fan redundancy for most system configurations when configured with two power supply modules, all system fan rotors are operational, and ambient air remains at or below ASHRAE Class A2 limits. See [Appendix D](#) for supported configurations in fan failed mode.

If a single system fan fails, platform management adjusts the airflow of the remaining system fans and manages other platform features to maintain system thermals below critical limits. Fan redundancy is lost if more than one system fan fails.

For system configurations that support fan redundancy, if a fan rotor fails, integrated platform management does the following:

- Changes the state of the system status LED to blinking green
- Reports an error to the system event log
- Automatically adjusts fan speeds of the remaining operational fans as needed to maintain system temperatures below maximum thermal limits.

**Note:** All system fans are controlled independently of each other. The fan control system may adjust fan speeds for different fans based on increasing/decreasing temperatures in different thermal zones within the chassis.

If system temperatures continue to increase with the system fans operating at their maximum speed, platform management may begin to throttle I/O bandwidth of either the memory subsystem, the processors, or both. It does this action to keep components from overheating and keep the system operational. Throttling of these subsystems continues until system temperatures are reduced below preprogrammed limits.

If system thermals increase to a point beyond the maximum thermal limits, the system shuts down, the system status LED changes to solid amber, and the event is logged to the system event log.

The power supply is protected against over temperature conditions caused by excessive ambient temperature. If such a condition occurs, the power supply module shuts down to protect itself from overheating.

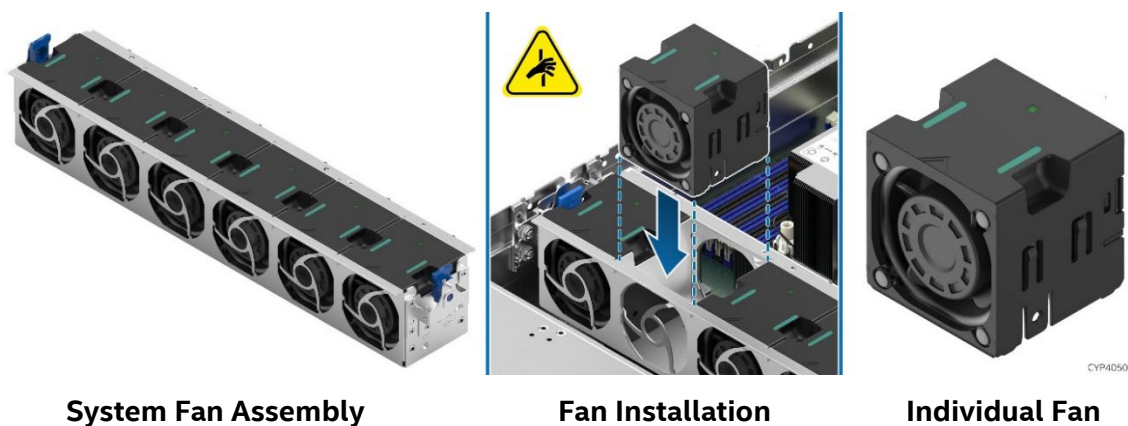
If the temperature within the power supplies increases to a point beyond their maximum thermal limits, or if a power supply fan should fail, the power supply shuts down.

### 4.3 System Fans

Six 60 x 60 x 38-mm system fans and an embedded fan for each installed power supply module provide the primary airflow for the system. All six system fans are mounted within a single fan assembly module that can be removed for cable routing or to service other components within the chassis.

Each system fan supports the following:

- Hot-swappable
- Is blind-mated to a matching 6-pin fan connector on the server board.
- Is designed for tool-less insertion and extraction from the fan assembly.
- Has a tachometer signal that allows the integrated BMC to monitor its status.
- Fan speed is controlled by integrated platform management. As system thermals fluctuate high and low, the integrated BMC firmware increases and decreases the speeds to specific fans within the fan assembly to regulate system thermals.
- Integrated fault LED. Platform management illuminates the fault LED to amber for the failed fan.



**Figure 35. System Fan Assembly**

All system fans are hot-swappable and require no tools for replacement. However, to access the system fans, the top cover panel must be removed. Fan rotors spin at very high speeds. Exercise extreme caution when hot swapping a system fan. For safety, Intel recommends replacing a faulty system fan with the system powered off whenever possible.



## 4.4 Power Supply Module Fans

Each installed power supply module includes an embedded (non-removable) 40-mm fan. This fan is responsible for airflow through the power supply module and is managed by the fan control system.

The power supply will shut down if its fan fails.

## 4.5 Fan Speed Control

The BMC controls and monitors the system fans. Each fan is associated with a fan speed sensor that detects a fan failure. It may also be associated with a fan presence sensor for hot-swap support. For redundant fan configurations, the fan failure status and fan presence status determine the fan redundancy sensor state.

The system fans are divided into fan domains, each of which has a separate fan speed control signal, and a separate configurable fan control policy. A fan domain can have a set of temperature and fan sensors associated with it. The sensors are used to determine the current fan domain state.

A fan domain has three states: sleep, boost, and nominal. The sleep and boost states have fixed (but configurable through OEM SDRs) fan speeds associated with them. The nominal state has a variable speed determined by the fan domain policy. An OEM SDR record is used to configure the fan domain policy.

The fan domain state is controlled by several factors, listed in the following bullets in order of precedence from high to low. If any of these conditions apply, the fans are set to a fixed boost state speed.

- An associated fan is in a critical state or missing. The SDR describes which fan domains are boosted in response to a fan failure or removal in each domain. A fan cannot be detected if it is removed when the system is in fans-off mode.
- Any associated temperature sensor is in a critical state. The SDR describes which temperature-threshold violations cause fan boost for each fan domain.
- The BMC is in a firmware update mode or the operational firmware is corrupted.

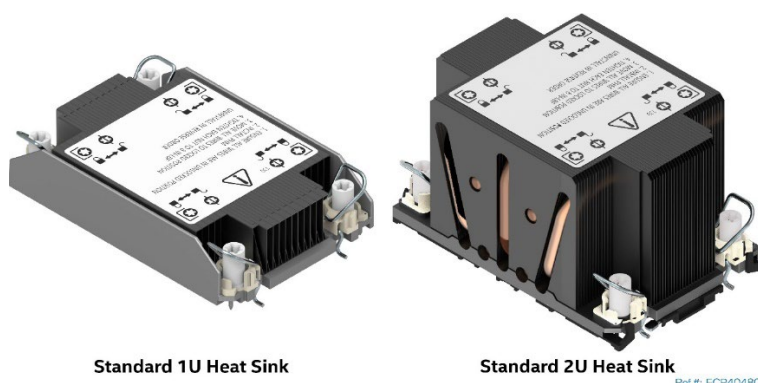
## 4.6 Processor Heat Sink Options

The Intel® Server System M50FCP2UR supports two types of processor heat sinks as shown in the following figure: standard 2U heat sink and standard 1U heat sink. The type of heat sink used depends on the system configuration and its thermal requirements.

---

Note: Server systems using the GPGPU air duct option must use the standard 1U heat sink.

---



Standard 1U Heat Sink

Standard 2U Heat Sink

Ref #: FCP40480

**Figure 36. Supported Processor Heat Sinks**

## 4.7 Air Duct Support Options

Intel® Server System M50FCP2UR supports three types of air ducts. The air duct is pre-installed in the system. The type of air duct shipped with the system depends on the processor heat sink and add-in cards installed in the system. These air ducts can also be ordered as accessory options.

Standard air duct for systems with standard 2U height heat sink(s). The accessory kit (iPC – **FCPDUCTSTD**) includes the air duct with two battery backup unit (BBU) brackets.

Standard air duct for systems with standard 1U height heat sink(s). The accessory kit (iPC – **FCPDUCTCMN**) includes the air duct with two BBU brackets for single width FH/FL riser cards.

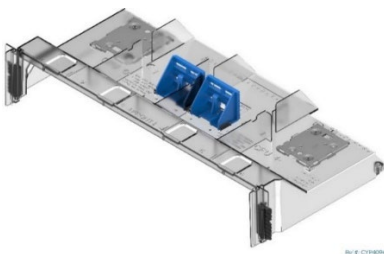
General Purpose Graphics Processing Unit (GPGPU) air duct for systems with standard 1U height heat sink(s) and accelerator (GPGPU) add-in cards, the accessory kit (iPC-FCPGPGPUKIT) includes the GPGPU air duct with two BBU brackets, air duct bracket, and three types of power cables (2 Pieces for each type)

- Standard air duct for systems with standard 2U height processor heat sinks. (iPC **FCPDUCTSTD**).



**Figure 37. Standard Air Duct for 2U Height Processor Heat Sinks**

- Optional air duct for systems with standard 1U height heat sink(s). (iPC **FCPDUCTCMN**)



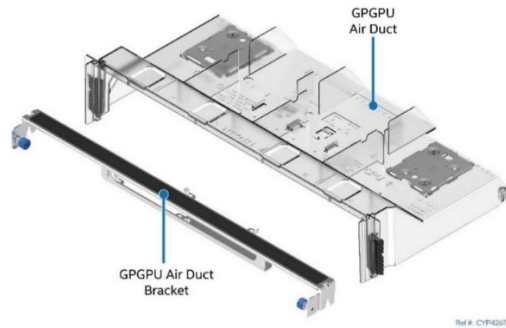
**Figure 38. Optional Air Duct for 1U Height Processor Heat Sinks**

- Optional GPGPU air duct for systems with standard 1U height heat sinks and accelerator (GPGPU) add-in cards. (iPC **FCPGPGPUKIT**).

---

**Note:** The air duct only supports accelerator cards with passive heat sinks.

---



**Figure 39. Optional GPGPU Air Duct for 1U Height Processor Heat Sink and GPGPU Add-In Cards**

## 5. PCI Express\* (PCIe\*) Subsystem Overview

4<sup>th</sup> & 5<sup>th</sup> Gen Intel® Xeon® Scalable processors provide up to 80 PCIe bus lanes that support the PCIe Express Base Specification, Revision 5.0 and Compute Express Link Specification 1.1 (CXL 1.1).

PCIe bus lanes from each processor and the Intel® C741 chipset are used to support various system features as shown in the following architectural diagram.

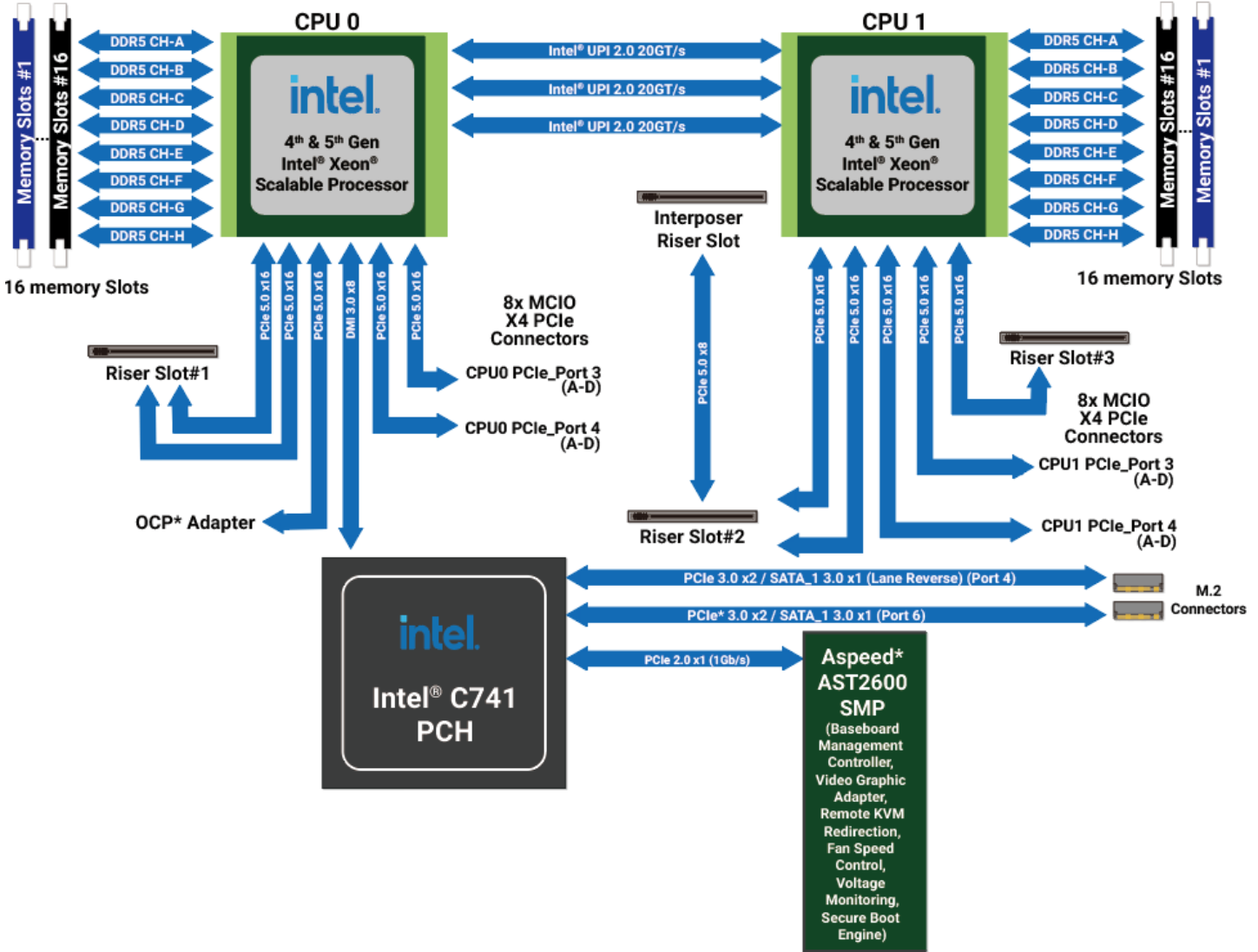


Figure 40. PCIe Subsystem Architecture

**Note:** A dual processor configuration is required to support all onboard PCIe features.

Intel® UPI link speed 20GT/s depends on 5<sup>th</sup> Gen processor.

For more CXL information refer to the 4th and 5th Gen Intel® Xeon® Scalable processors family BIOS Firmware External Product Specification (EPS).

**Table 16. Processor / Chipset PCIe\* Port Routing**

Host	Port	Width	Gen.	Usage
CPU 0	Port 0A–0D	x16	4.0	OCP* Adapter connector
	Port 1A–1D	x16	5.0	Riser Slot #1 [15:0]
	Port 2A–2D	x16	5.0	Riser Slot #1 [31:16]
	Port 3A–3D	x16	5.0	Server board PCIe MCIO connectors
	Port 4A–4D	x16	5.0	Server board PCIe MCIO connectors
	DMI3	x8	3.0	Chipset PCH
CPU 1	Port 0A–0D	x16	5.0	Riser Slot #3 [15:0]
	Port 1A–1D	x16	5.0	Riser Slot #2 [31:16]
	Port 2A–2D	x16	5.0	Riser Slot #2 [15:0]
	Port 3A–3D	x16	5.0	Server board PCIe MCIO connectors
	Port 4A–4D	x16	5.0	Server board PCIe MCIO connectors
Chipset PCH	Port 8–9	x2	3.0	M.2 Connector- SATA / PCIe
	Port 10–11	x2	3.0	M.2 Connector- SATA / PCIe

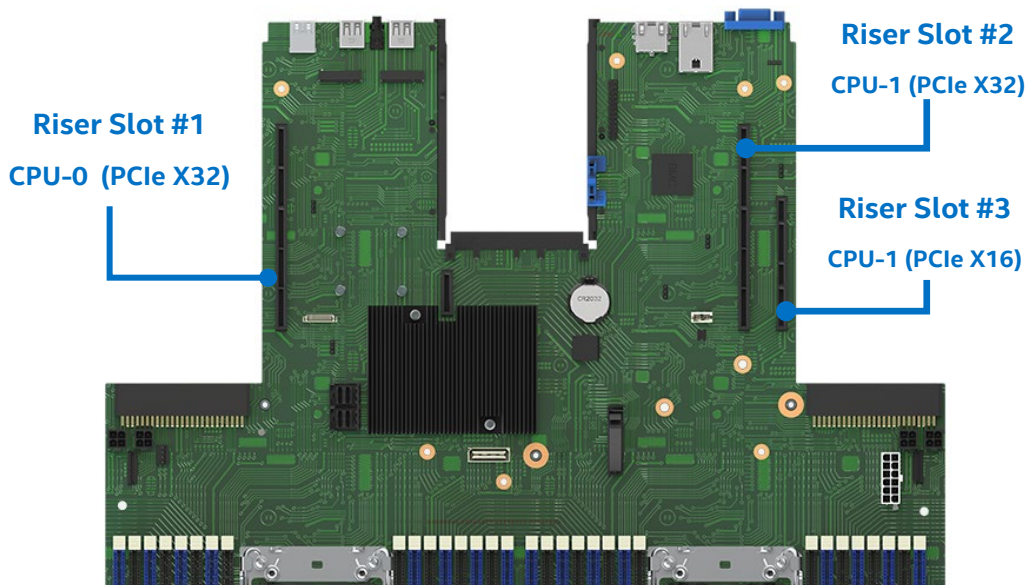
On the server board, PCIe bus lanes are used to support the following features:

- Three PCIe Riser Card slots
- One OCP 3.0 Interface connector
- Sixteen PCIe MCIO\* connectors for NVMe support (Up to twelve used in the 1U system)
- Two M.2 SSD connectors

This chapter provides an overview of each.

## 5.1 PCIe Riser Slots

The server board includes three riser slots, identified as Riser Slot #1, Riser Slot #2, and Riser Slot #3. PCIe bus lanes for each riser slot is supported from either CPU-0 or CPU-1 (See [Figure 41](#)).



**Figure 41. Riser Card Slots**

With three riser cards installed, the system can support up to eight PCIe add-in cards. PCIe add-in card slots are fully compliant with the *PCIe Base Specification* (revision 5.0) supporting the following PCIe bit rates: 5.0 (32 GT/s), 4.0 (16 GT/s), 3.0 (8.0 GT/s), 2.0 (5.0 GT/s), and 1.0 (2.5 GT/s).

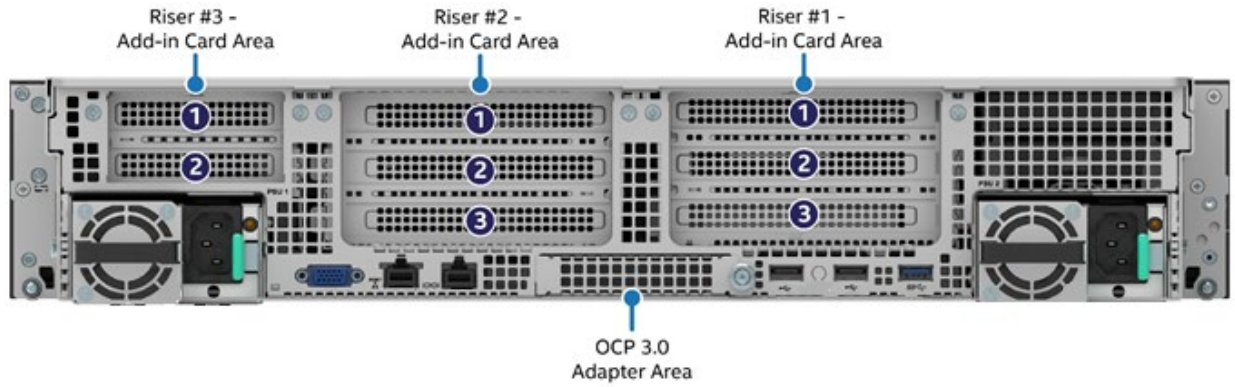
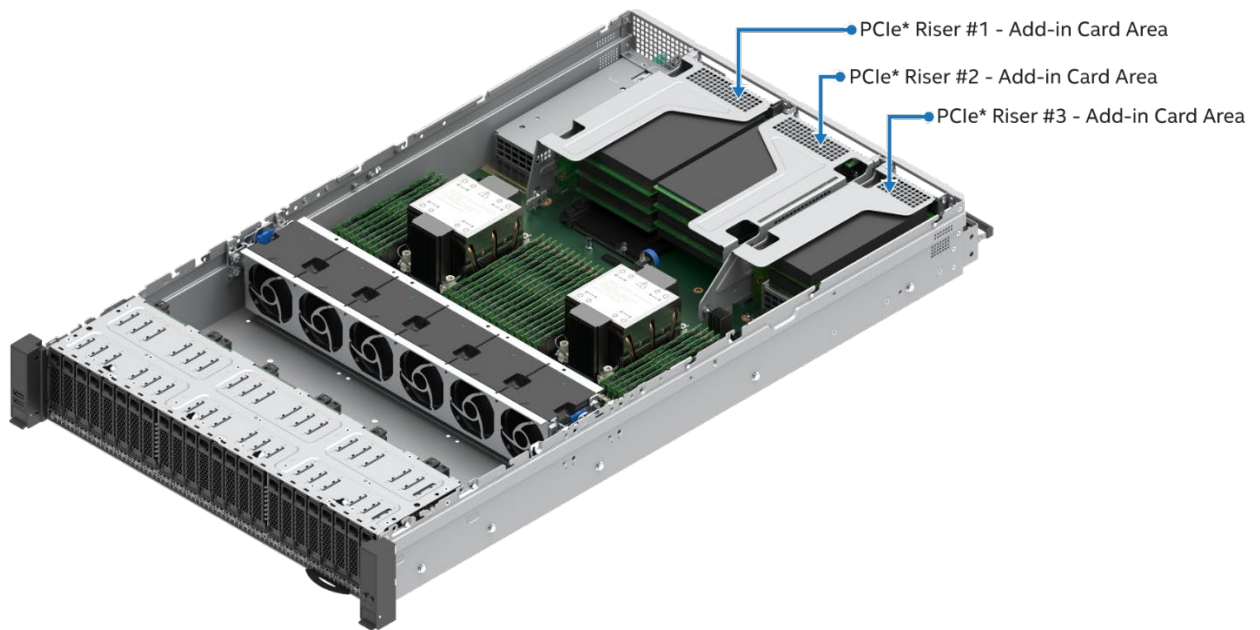


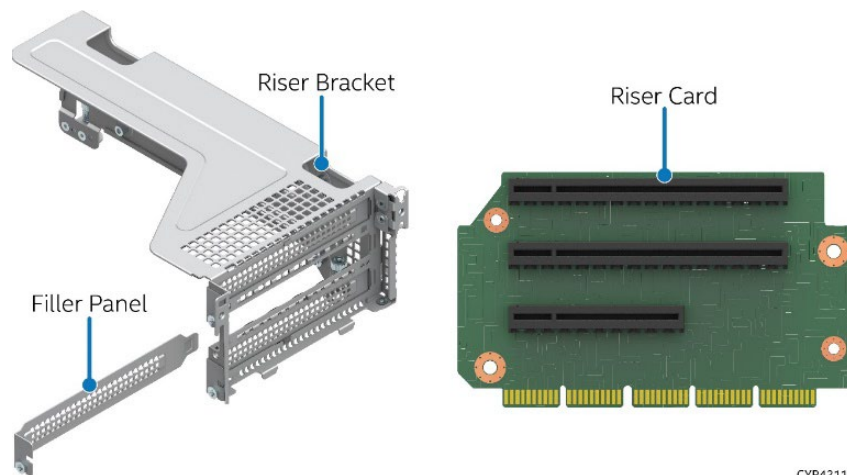
Figure 42. Server System Back Panel Add-In Card Areas



Ref #: FCP20420

Figure 43. Server System PCIe\* Riser Add-In Card Areas

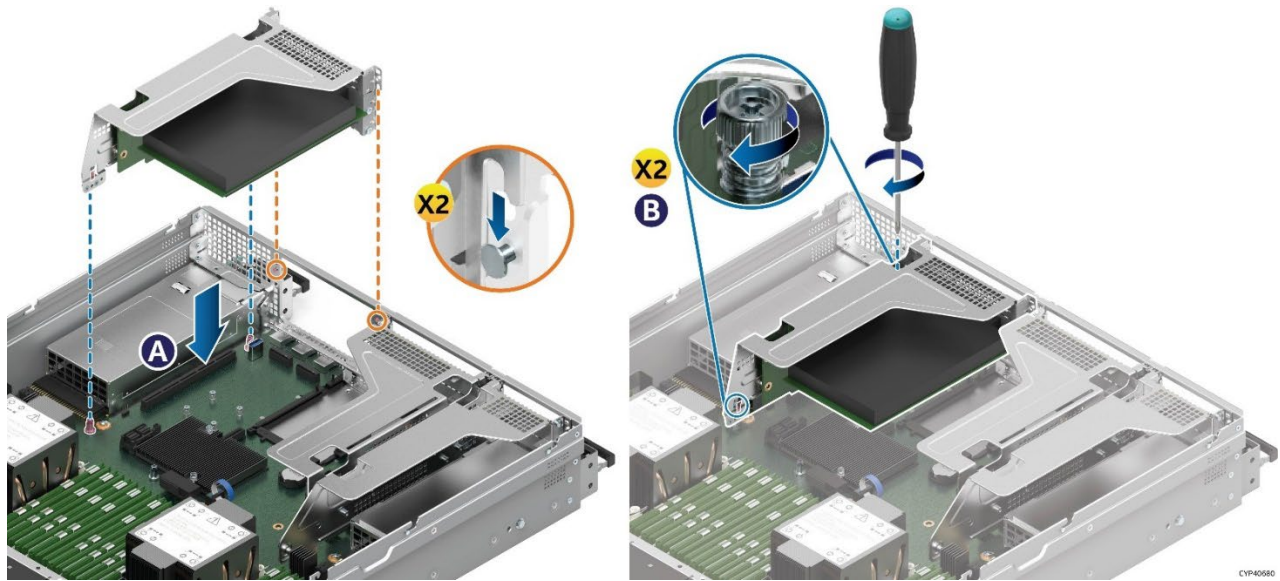
PCIe add-in cards are installed into a riser card assembly consisting of a riser card bracket, a riser card, and a filler plate.



CYP42111

Figure 44. Riser Card Assembly Components

Riser card assemblies are installed into the system by positioning the alignment key slots on the back of the riser bracket over a pair of alignment keys located on the chassis back panel. The assembly is then lowered until the edge connector of the riser card is firmly seated within the riser slot on the server board. Using a screwdriver, the riser assembly is then secured to the server board using a pair of captive screw heads on the riser bracket, which are tightened onto a pair of threaded captive screws protruding up from the server board.



**Figure 45. Riser Card Assembly Installation**

Depending on the system configuration, the server system may or may not come pre-configured with riser card options installed. However, all system configurations include the mounting brackets and filler plates for supported riser card options.

### 5.1.1 Determining where to install a PCIe add-in card

A steady flow of air over PCIe add-in cards ensures they operate with reliable operation and best performance. The air flow supporting the PCIe add-in card areas within the Intel® Server System M50FCP2UR will vary depending on the location of the riser card and possibly the location of the add-in card slot on the riser card. Some add-in card slots may not be able to support the air flow requirements of some high power PCIe add-in cards.

The following tables provide the air flow limits supported by each riser slot location and add-in card slot for different system configurations.

**Table 17. PCIe\* Add-In Card Airflow (LFM) Support Limits – M50FCP2UR208 based x8, x16, x24 Front Drive Bay Systems, M50FCP2UR312 Fan Normal**

PCIe* Add-In Slot	Riser Slot #1 (LFM)	Riser Slot #2 (LFM)	Riser Slot #3 (LFM)
Top	300	300	300
Middle	300	300	N/A
Bottom	300	300	300

**Table 18. PCIe\* Add-In Card Airflow (LFM) Support Limits – M50FCP2UR312 Fan Failure**

PCIe* Add-In Slot	Riser Slot #1 (LFM)	Riser Slot #2 (LFM)	Riser Slot #3 (LFM)
Top	200	200	100
Middle	200	200	N/A
Bottom	200	200	100

**Table 19. PCIe\* Add-In Card Airflow (LFM) Support Limits – M50FCP2UR208 based x8, x16, x24 Front Drive Bay Systems Fan Failure**

PCIe* Add-In Slot	Riser Slot #1 (LFM)	Riser Slot #2 (LFM)	Riser Slot #3 (LFM)
Top	300	300	300
Middle	300	300	N/A
Bottom	300	300	300

Using this data, along with information from add-in card data sheets, system integrators should be able to determine which riser card location and add-in slot will meet the air flow requirements for the chosen PCIe add-in card.

## 5.2 PCIe\* Riser Card Options

Several PCIe riser card options are available for this server system family. The following sections list the different options. The available riser card options are riser slot specific and are not interchangeable between the server board riser slots.

- Add-in cards installed to a riser card in Riser Slot #1 must be oriented with component side up
- Add-in cards installed to a riser card in Riser Slot #2 must be oriented with component side down.
- Add-in cards installed to a riser card in Riser Slot #3 must be oriented with component side up.

The Intel® Server System M50FCP2UR supports PCIe bifurcation for each riser slot. To change the PCIe bifurcation setting, access the BIOS setup utility by pressing <F2> key during POST. Navigate to the following menu: **Advanced > Integrated IO Configuration > PCIe Slot Bifurcation Setting**.

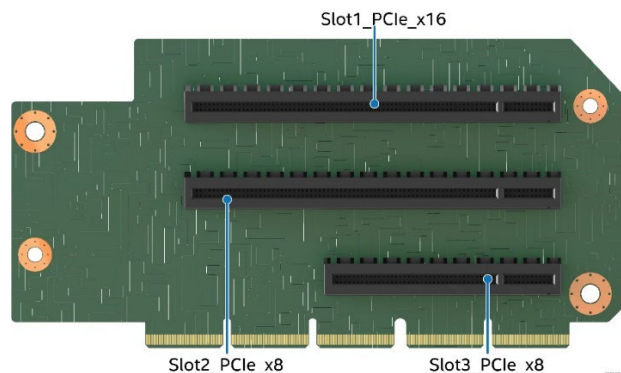
**Note:** In any riser card option, each PCIe\* add-in card slot is connected to clock signals. When a PCIe\* add-in card slot is configured with any of the available bifurcation options in the BIOS, the slot provides clock signals to only one of the bifurcated PCIe\* data lane groups. The add-in card must provide clock signals to the remaining PCIe\* data lane groups.

In the following sections, FL = Full Length, HL = Half Length, FH = Full Height, LP = Low Profile.

### 5.2.1 3-Slot PCIe\* Riser Card for Riser Slot #1 (iPC FCP2URISER1STD)

The three-slot PCIe riser card option supports:

- One FH/FL single-width add-in card slot (x16 electrical, x16 mechanical)
- One FH/FL single-width add-in card slot (x8 electrical, x16 mechanical)
- One FH/HL single-width add-in card slot (x8 electrical, x8 mechanical)
- Supported PCIe Bifurcation – Add-in card slot 1 in 3-Slot PCIe riser card: x16/x8x8/x8x4x4/x4x4x8/x4x4x4x4



**Figure 46. 3-Slot PCIe\* Riser Card for Riser Slot #1**



**Table 20. PCIe\* Riser Card Connector Description**

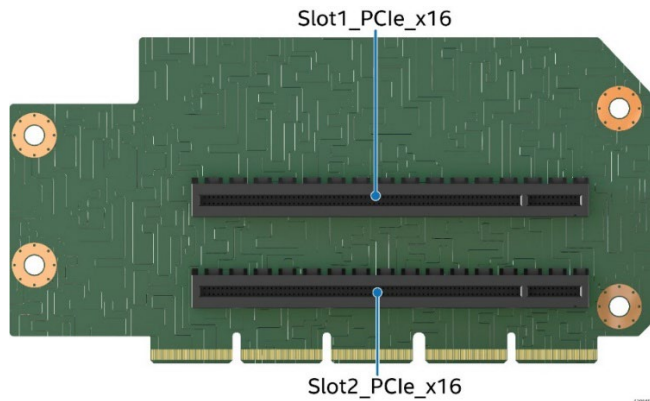
Connector	Add-in Card Slot Description	PCIe Port Mapping	Maximum Available Power (W)
Slot1_PCl_e_x16	x16 electrical, x16 mechanical	CPU 0 – Ports 2A through 2D	75
Slot2_PCl_e_x8	x8 electrical, x16 mechanical	CPU 0 – Ports 1A and 1B	50
Slot3_PCl_e_x8	x8 electrical, x8 mechanical	CPU 0 – Ports 1C and 1D	25

**5.2.2 2-Slot PCIe\* Riser Card for Riser Slot #1 (iPC FCP2URISER1DW)**

The two-slot PCIe riser card option supports:

- One FH/FL double-width slot (x16 electrical, x16 mechanical)
- One FH/HL single-width slot (x16 electrical, x16 mechanical)
- Supported PCIe Bifurcation – Add-in card slot 1 or slot 2 in 2-Slot PCIe riser card: x16/x8x8/x8x4x4/x4x4x8/x4x4x4x4

**Note:** Support for high-power double-width add-in cards requires the system configuration to include the use of a 1U CPU heat sink and GPGPU air duct.



**Figure 47. Two-Slot PCIe\* Riser Card for Riser Slot #1**

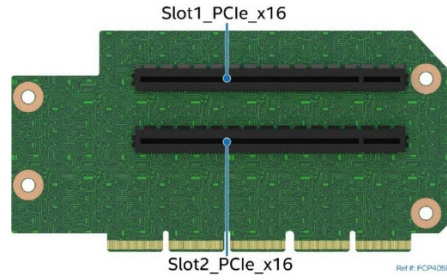
**Table 21. Two-slot PCIe\* Riser Card Connector Description**

Connector	Add-in Card Slot Description	PCIe Port Mapping	Maximum Available Power (W)
Slot1_PCl_e_x16	x16 electrical, x16 mechanical	CPU 0 – Ports 2A through 2D	75
Slot2_PCl_e_x16	x16 electrical, x16 mechanical	CPU 0 – Ports 1A through 1D	75

**5.2.3 2-Slot PCIe\* Riser Card for Riser Slot #1 (iPC FCP2URISER1SW)**

The two-slot PCIe riser card option supports:

- Two FH/FL single-width slot (x16 electrical, x16 mechanical)
- Supported PCIe Bifurcation – Add-in card slot 1 or slot 2 in 2-Slot PCIe riser card: x16/x8x8/x8x4x4/x4x4x8/x4x4x4x4



**Figure 48. Two-Slot PCIe\* Riser Card for Riser Slot #1**

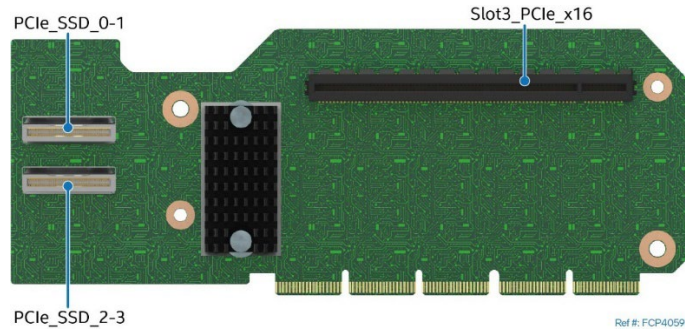
**Table 22. Two-slot PCIe\* Riser Card Connector Description**

Connector	Add-in Card Slot Description	PCIe Port Mapping	Maximum Available Power (W)
Slot1_PCl_e_x16	x16 electrical, x16 mechanical	CPU 0 – Ports 2A through 2D	75
Slot2_PCl_e_x16	x16 electrical, x16 mechanical	CPU 0 – Ports 1A through 1D	75

### 5.2.4 PCIe\* NVMe\* Riser Card for Riser Slot #1 (iPC FCP2URISER1RTM)

The PCIe NVMe riser card option supports:

- One HL or FL single-width slot (x16 electrical, x16 mechanical)
- Two x8 PCIe MCIO cable connectors



**Figure 49. PCIe\* NVMe\* Riser Card for Riser Slot #1**

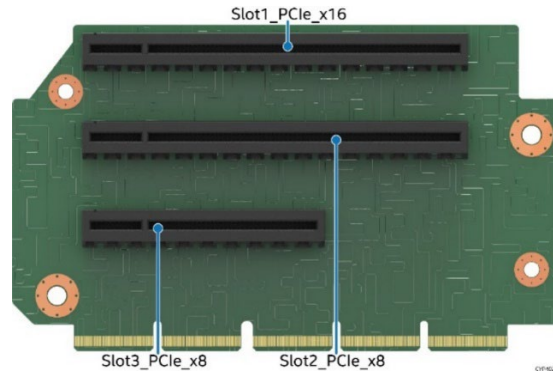
**Table 23. PCIe\* NVMe\* Riser Card Connector Description**

Connector	Add-in Card Slot Description	PCIe Port Mapping	Maximum Available Power (W)
Slot3_PCl_e_x16	x16 electrical, x16 mechanical	CPU 0 – Ports 1A through 1B	75
PCl_e_SSD_0-1	X8 PCIe MCIO cable connector	CPU 0 – Ports 2A through 2B	N/A
PCl_e_SSD_2-3	X8 PCIe MCIO cable connector	CPU 0 – Ports 2C through 2D	N/A

### 5.2.5 3-Slot PCIe\* Riser Card for Riser Slot #2 (iPC FCP2URISER2STD)

The three-slot PCIe riser card option supports:

- One FH/FL single-width slot (x16 electrical, x16 mechanical)
- One FH/FL single-width slot (x8 electrical, x16 mechanical)
- One FH/HL single-width slot (x8 electrical, x8 mechanical)
- Supported PCIe Bifurcation – Add-in card slot 1 in 3-Slot PCIe riser:  
x16/x8x8/x8x4x4/x4x4x8/x4x4x4x4



**Figure 50. Three-slot PCIe\* Riser Card for Riser Slot #2**

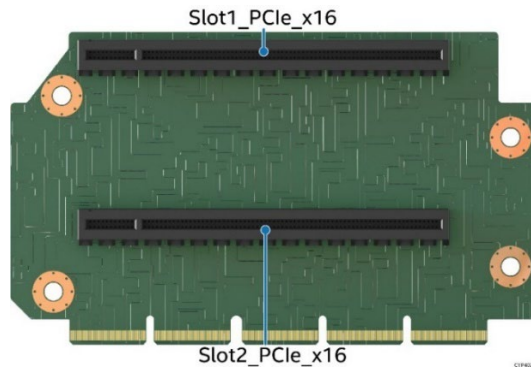
**Table 24. Three-Slot PCIe\* Riser Card Connector Description**

Connector	Add-in Card Slot Description	PCIe Port Mapping	Maximum Available Power (W)
Slot1_PCl_e_x16	x16 electrical, x16 mechanical	CPU 1 – Ports 1A through 1D	75
Slot2_PCl_e_x8	x8 electrical, x16 mechanical	CPU 1 – Ports 2A and 2B	50
Slot3_PCl_e_x8	x8 electrical, x8 mechanical	CPU 1 – Ports 2C and 2D	25

### 5.2.6 2-Slot PCIe\* Riser Card for Riser Slot #2 (iPC FCP2URISER2DW)

The two-slot PCIe riser card option supports:

- One FH/FL double-width slot (x16 electrical, x16 mechanical)
- One FH/HL single-width slot (x16 electrical, x16 mechanical)
- Supported PCIe Bifurcation – Add-in card slot 1 or slot 2 in 2-Slot PCIe riser card: x16/x8x8/x8x4x4/x4x4x8/x4x4x4x4



**Figure 51. Two-slot PCIe\* Riser Card for Riser Slot #2**

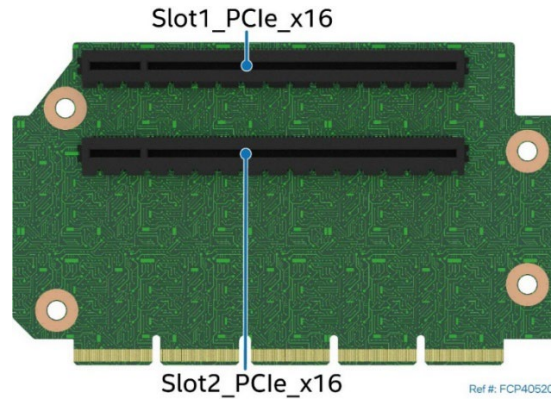
**Table 25. Two-Slot PCIe\* Riser Card Connector Description**

Connector	Add-in Card Slot Description	PCIe Port Mapping	Maximum Available Power (W)
Slot1_PCl_e_x16	x16 electrical, x16 mechanical	CPU 1 – Ports 1A through 1D	75
Slot2_PCl_e_x16	x16 electrical, x16 mechanical	CPU 1 – Ports 2A through 2D	75

### 5.2.7 2-Slot PCIe\* Riser Card for Riser Slot #2 (iPC FCP2URISER2SW)

The two-slot PCIe riser card option supports:

- Two FH/FL single-width slots (x16 electrical, x16 mechanical)



**Figure 52. Two-slot PCIe\* Riser Card for Riser Slot #2**

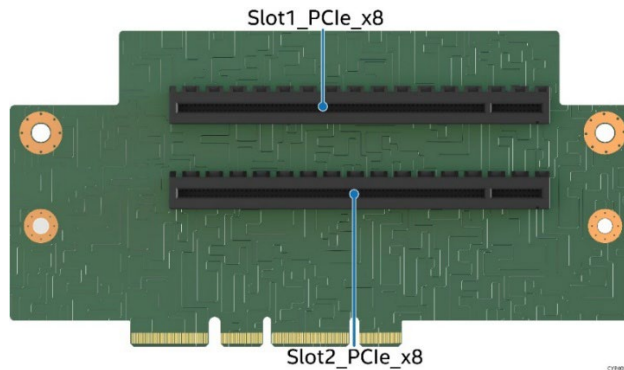
**Table 26. Two-slot PCIe\* Riser Card Connector Description**

Connector	Add-in Card Slot Description	PCIe Port Mapping	Maximum Available Power (W)
<b>Slot1_PCl_e_x16</b>	x16 electrical, x16 mechanical	CPU 1 – Ports 1A through 1D	75
<b>Slot2_PCl_e_x16</b>	x16 electrical, x16 mechanical	CPU 1 – Ports 2A through 2D	75

### 5.2.8 2-Slot PCIe\* Riser Card for Riser Slot #3 (iPC FCP2URISER3STD)

The two slot PCIe riser card option supports:

- Two LP/HL single-width slots (x8 electrical, x16 mechanical)



**Figure 53. Two-slot PCIe\* Riser Card for Riser Slot #3**

**Table 27. Two-slot PCIe\* Riser Card Connector Description**

Connector	Add-in Card Slot Description	PCIe Port Mapping	Maximum Available Power (W)
<b>Slot1_PCl_e_x8</b>	X8 electrical, x16 mechanical	CPU 1 – Ports 0A and 0B	40
<b>Slot2_PCl_e_x8</b>	X8 electrical, x16 mechanical	CPU 1 – Ports 0C and 0D	40

### 5.2.9 PCIe NVMe Riser Card for Riser Slot #3 (iPC CYPRISER3RTM)

This riser slot #3 riser card option is used to provide support for up to four additional PCIe NVMe SSD configured within the front drive bay.

The PCIe NVMe riser card option supports:

- Two X8 PCIe MCIO cable connectors



**Figure 54. PCIe NVMe Riser Card for Riser Slot#3**

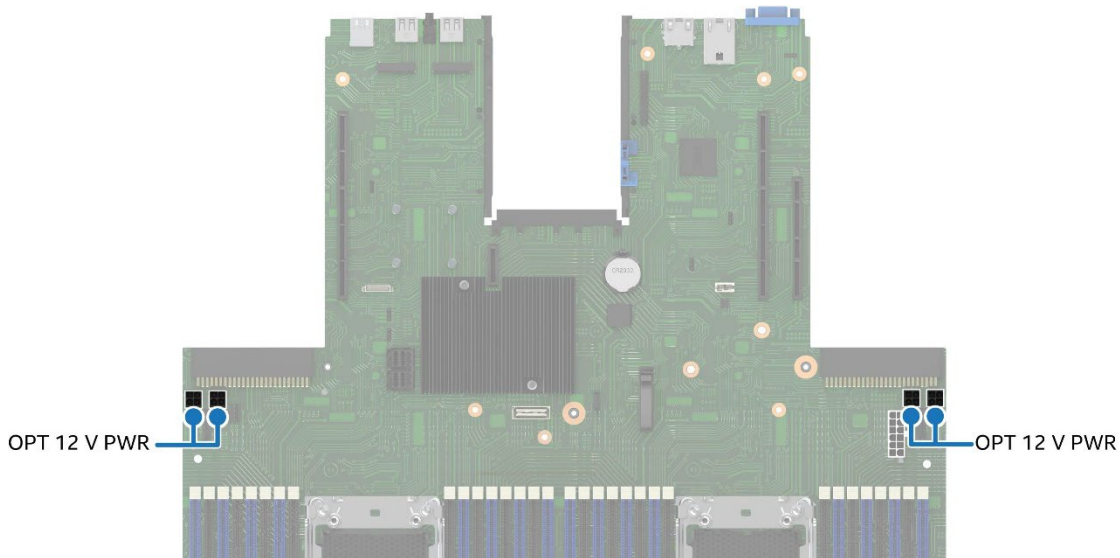
Connector	Add-in Card Slot Description	PCIe Port Mapping	Maximum Available Power (W)
PCIe_SSD_0-1	X8 PCIe MCIO cable connector	CPU 1 – Ports 0C–0D	N/A
PCIe_SSD_2-3	X8 PCIe MCIO cable connector	CPU 1 – Port 0A–0B	N/A

### 5.2.10 Auxiliary 12-Volt Power

Riser Slot #1 and Riser Slot #2 on the server board can each supply a maximum of 100W power. When a riser card is installed, the 100W is split to support all add-in slots of the riser, with a single add-in slot maximum of 75W. For GPU or other high-power add-in cards that require >75W of power to operate, additional 12-volt auxiliary power must be supplied directly to the card from an alternate power source. In the Intel® Server System M50FCP2UR, additional 12-volt power for add-in cards can be drawn from any of four 4-pin (white 2x2) power connectors on the server board. These connectors are labeled “OPT\_12V\_PWR” (See Figure 55).

A cable from these connectors may be routed to a power-in connector on the given add-in card. Maximum power draw from each connector is 225 W but is also limited by available power provided by the power supply and the total power draw of the given system configuration. A power budget calculation for the complete system should be performed to determine how much supplemental 12-volt power is available to support high-power add-in cards.

Four 12-Volt Aux power cables are included with Intel Accessory Kit – iPC FCPGPGPUKIT.



**Figure 55. Auxiliary 12-Volt Power Connectors**

The following table provides the pinout for the 12-V power connectors.

**Table 28. Auxiliary Power Connector Pinout ("OPT\_12V\_PWR")**

Pin #	Signal Name
1	GROUND
2	GROUND
3	P12V
4	P12V

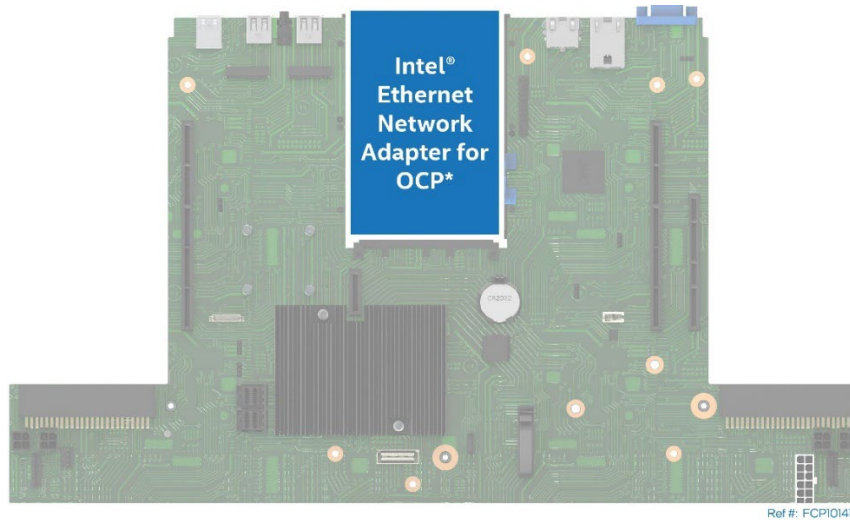
### 5.3 Intel® Ethernet Network Adapter for OCP\* Support

The Intel® Server System M50FCP2UR supports several types of Intel® Ethernet Network Adapters. Supported adapters adhere to the Open Compute Project (OCP) 3.0 specification, which utilizes an edge connector interface to the server board allowing the card to be serviced from outside of the chassis.

---

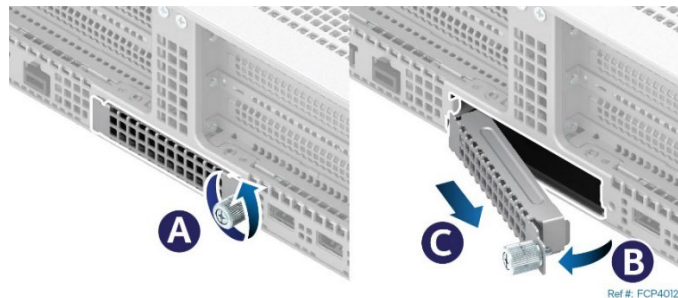
Note: Reference the *Intel® Server M50FCP Family Configuration Guide* for a list of supported adapter cards.

---

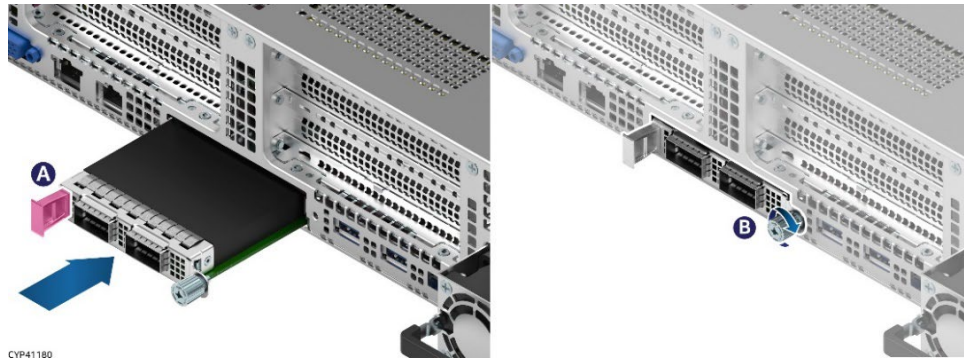


**Figure 56. Intel® Ethernet Network Adapter for OCP\* Placement**

OCP adapters supported by this product family are installed into an OCP bay on the back of the chassis.



**Figure 57. OCP\* Adapter Bay Filler Removal**



**Figure 58. OCP\* Adapter with Pull Tab Installation**

For more information on OCP module installation and removal of each OCP module type, see the *Intel® Server System M50FCP2UR System Integration and Service Guide*.

## 6. System Storage

The Intel® Server System M50FCP2UR has support for many data storage configuration options, including:

- Hot swap capable front drive bays with support for SATA, SAS, and NVMe\* drives
- Two internal M.2 SSD connectors
- Support for up to two internal fixed mount SATA SSDs
- Onboard support for both SATA and NVMe storage interfaces

This chapter provides an overview for each.

Additional Intel® VROC NVMe\* and Intel® VROC SATA capabilities are available. The Intel® Server System M50FCP2UR supports Intel® VROC 8.0.

---

**Note:** The rules and operations for Intel® VROC NVMe\* and Intel® VROC SATA are different from previous generation server systems. The rules and operations are discussed in this chapter.

---

### 6.1 Front Drive Bay Overview

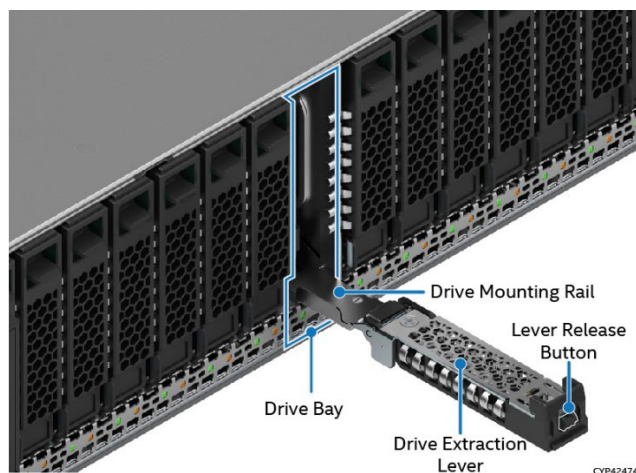
The Intel® Server System M50FCP2UR family has support for the following front drive bay configuration options.

- Up to 8 hot-swap drives (iPC M50FCP2UR208), expandable to 16 or 24 2.5" drives with optional accessory kits installed.
  - 2.5" SSD
  - SATA / SAS / NVMe
- Up to 12 hot-swap drives (iPC M50FCP2UR312):
  - 3.5" HDD or 2.5" SSD
  - 12 SATA / SAS HDD or SSD
  - 4 NVMe SSDs + 8 SAS/SATA HDDs/SSDs

The following figures illustrate the front drive bay options.

#### 6.1.1 2.5" Front Drive Overview

In 2.5" front drive bay server systems, all drives are mounted to a tool-less drive rail allowing for easy installation, extraction, and replacement. Drive rails have support for both 7mm and 15mm 2.5" SSDs. Drive rails do not detach from the drive bay. To install or remove a drive, the rail is pulled out a small distance from the drive bay allowing for a drive to be placed on to or removed from the rail.





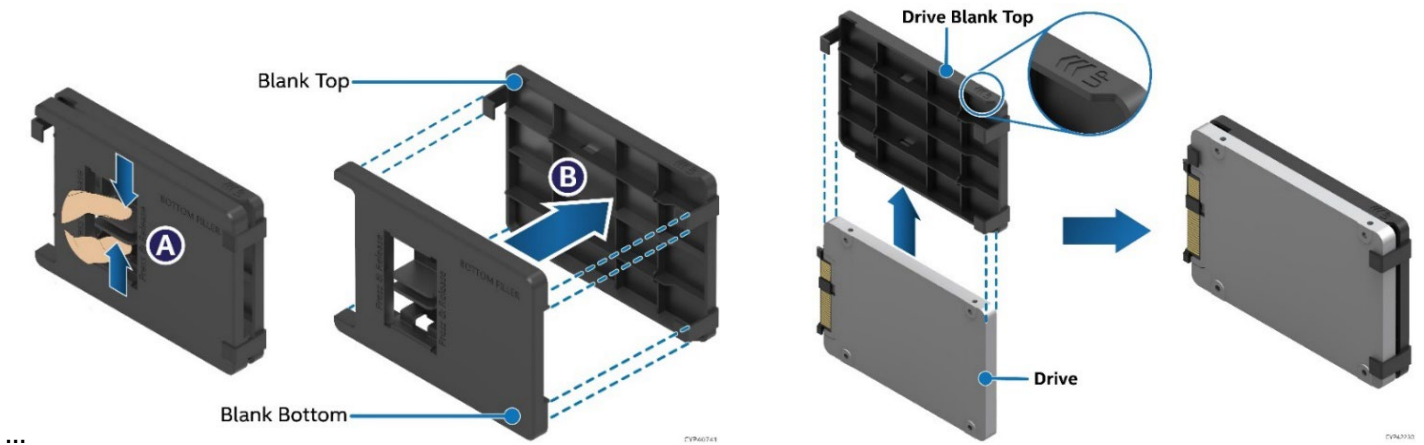
**Figure 59. 2.5" Drive Bay Components**

**Note:** The drive mounting rail does not detach from the chassis when pulled from the drive bay. The drive mounting rail extraction lever stops when it reaches its travel limit. Do not attempt to detach the drive mounting rail from the chassis. Doing so may damage the drive rail making it unusable.

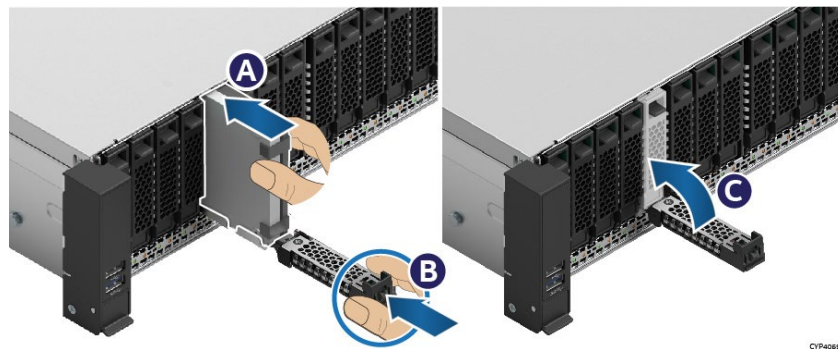
In support of system air flow and thermal management guidelines, all drive rails must be populated with a drive or supplied drive blank.

For system configurations that require support for 7mm SSDs, the drive blank is removed from the drive rail and separated into two sections, with one section to be used as an adapter that attaches to the 7mm drive.

Each drive carrier includes a 2.5" drive blank assembly. This assembly consists of two parts, top and bottom as shown in the following figure.



Drive installation into the front drive bay and extraction from the front drive bay is the same for both 7mm and 15mm height drives.



**Figure 60. 7-mm Drive Insertion into 2.5" Drive Bay**

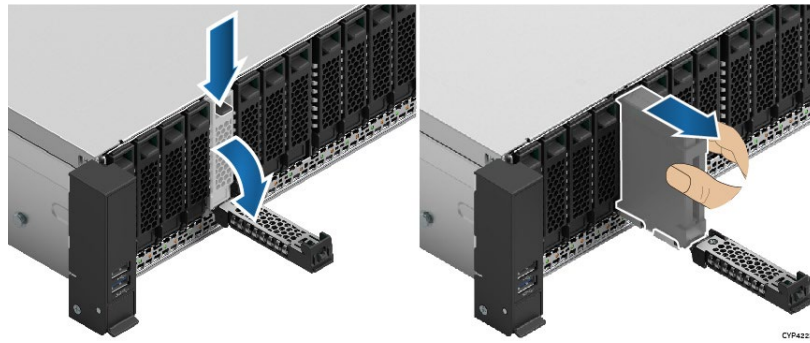


Figure 61. 7-mm Drive Removal from 2.5" Drive Bay

### 6.1.1.1 2.5" Front Drive Bay LED Support

Each drive bay includes two LED indicators, green for drive activity and amber for drive status. Light pipes integrated into the chassis direct light emitted from LEDs mounted next to each drive connector on the backplane to the drive front bay. The pipes make the LEDs visible from the front of the system.

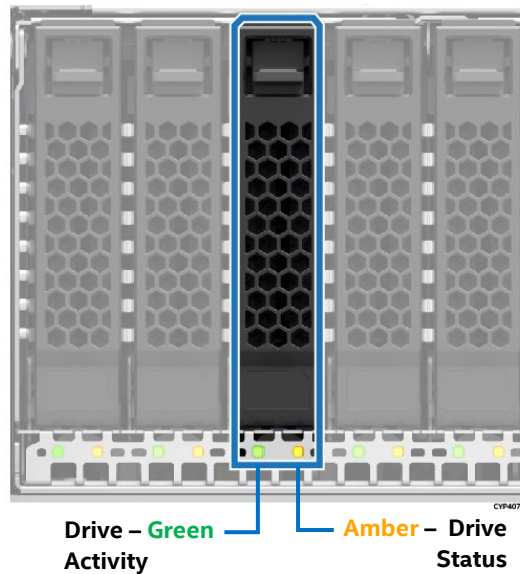


Figure 62. 2.5" Front Drive LED Identification

Table 29. 2.5" Front Drive Amber Status LED States

Amber	LED State	Drive Status
	Off	No access and no fault
	Solid on	Hard drive fault has occurred
	1 Hz blinking	RAID rebuild in progress
	2 Hz blinking	Locate (identify)

Table 30. 2.5" Front Drive Green Activity LED States

Green	Condition	Drive Type	LED Behavior
	Power on with no drive activity	SAS/NVMe*	LED stays on
		SATA	LED stays off
	Power on with drive activity	SAS/NVMe*	LED blinks off when processing a command
		SATA	LED blinks on when processing a command
Power on and drive spun down	SAS/NVMe*	LED stays off	

		SATA	LED stays off
	Power on and drive spinning up	SAS/NVMe*	LED blinks
		SATA	LED stays off

**Note:** The drive activity LED is driven by signals from the drive itself. Drive vendors may choose to operate the activity LED different from what is described in the above tables. If the activity LED on a given drive type behaves differently than what is described, customers should reference the drive vendor specifications. Obtain the specific drive model to determine the expected drive activity LED operation.

### 6.1.2 3.5" Front Drive Overview

In server systems that support twelve 3.5" front drive bays, all drives are mounted to a 3.5" drive carrier. The drive carriers are designed to support 3.5" hard disk drives or 2.5" (7 mm or 15 mm height) SSDs. In support of system air flow and thermal management guidelines, all drive carriers must be populated with a drive or supplied drive blank.

Inserting a drive into the front drive bay or extracting one from it is tool-less. A latching mechanism on the face of the carrier is used to assist with drive insertion and removal.

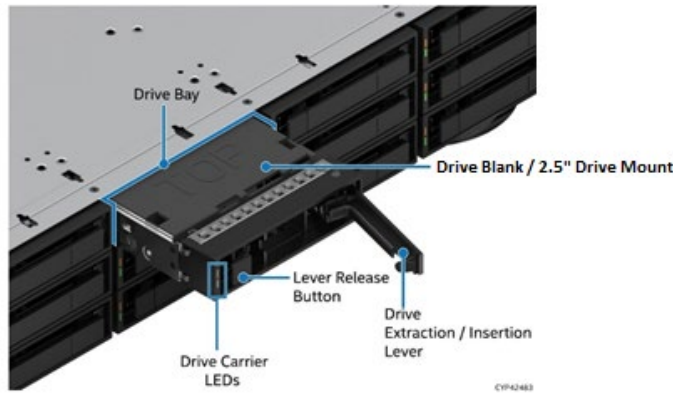


Figure 63. 3.5" Drive Bay Components

The drive carrier must be completely removed from the chassis to service a drive.

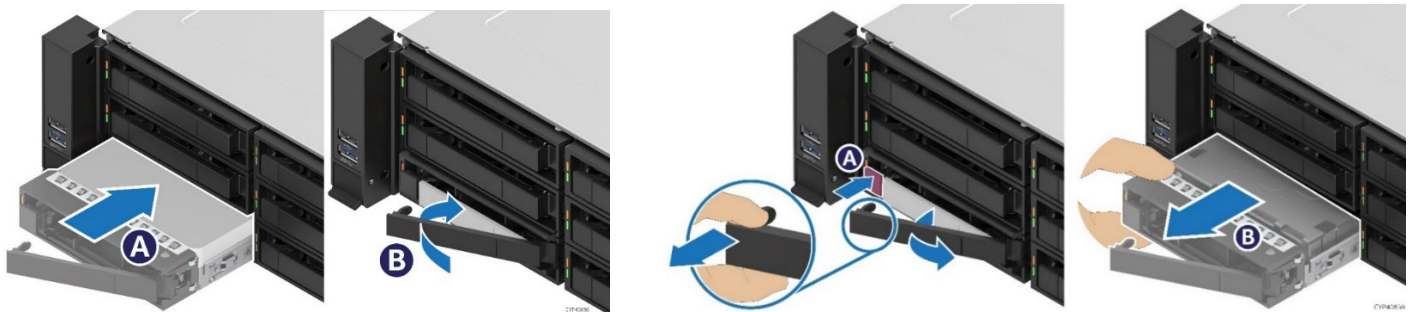
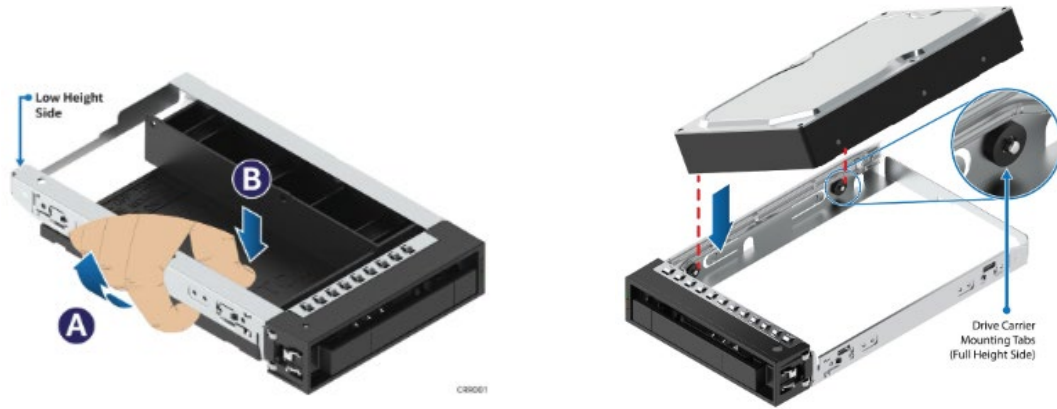


Figure 64. 3.5" Drive Insertion / Extraction

3.5" hard drives and the drive blank are easily installed or removed from the carrier without the need of tools.

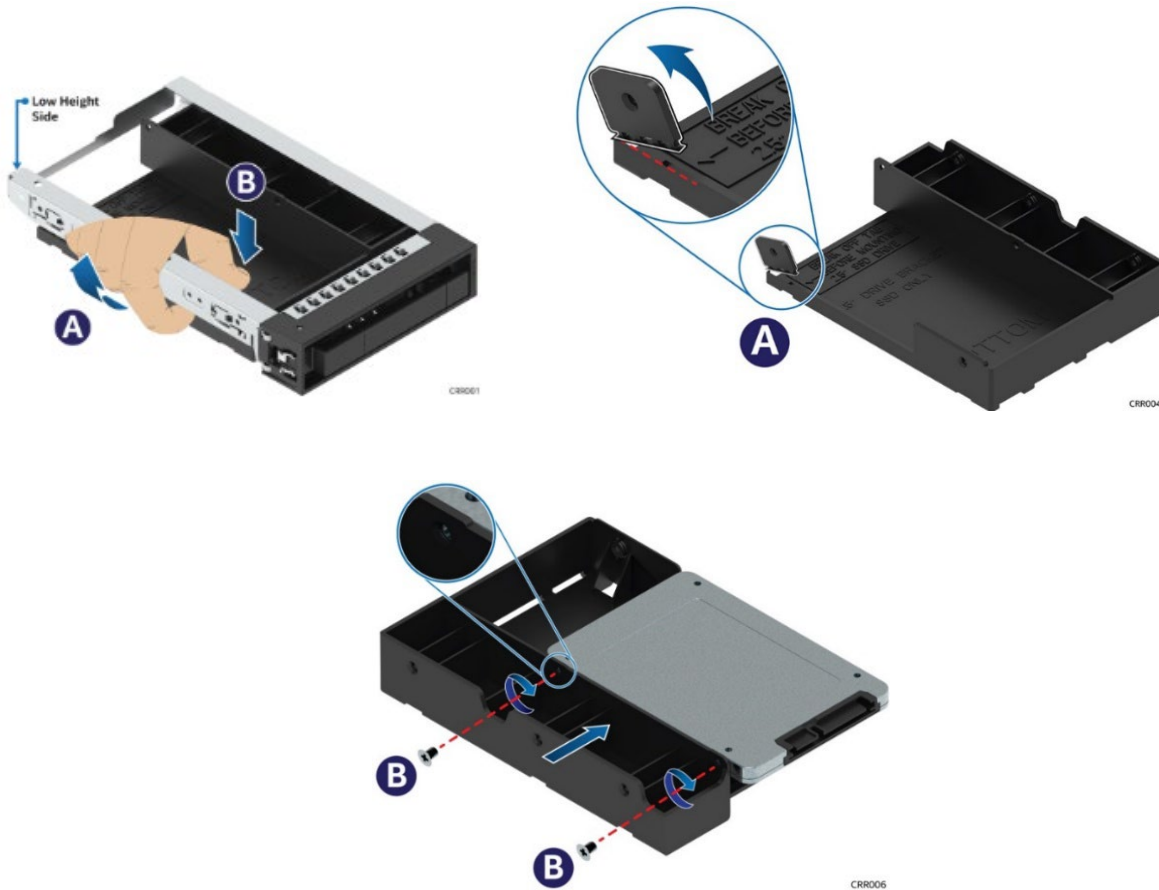


**Figure 65. 3.5" Drive Assembly**

To support 2.5" drives, the 3.5" drive blank is used as a mounting bracket for 2.5" SSDs..

**Note:** Due to degraded performance and reliability concerns, using the 3.5" drive blank to mount a 2.5" drive is intended to support SSD type storage devices only. Installing a 2.5" hard disk drive into the 3.5" drive blank is not supported.

The following figures show the procedure used to install a 2.5" SSD into the 3.5" drive blank. For step by step instructions, reference the *Intel® Server System M50FCP2UR Integration and Service Guide*.



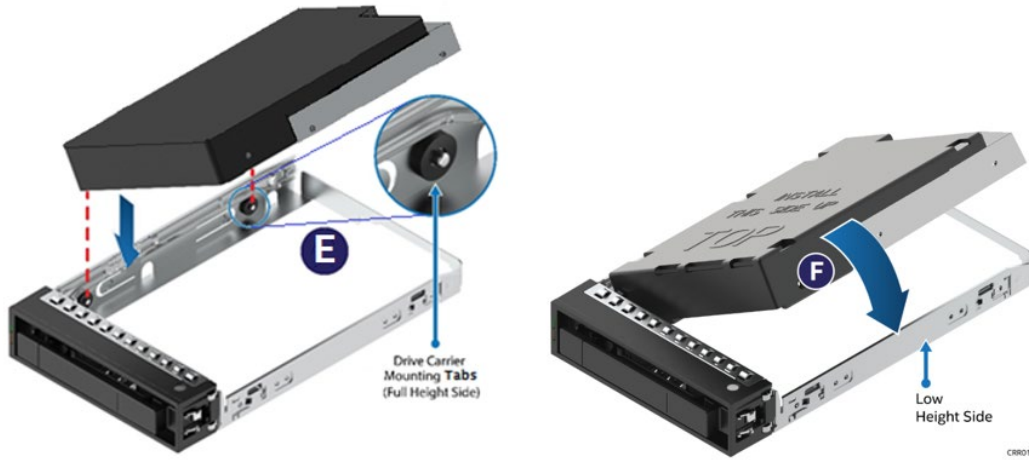


Figure 66. 2.5" SSD Assembly into Drive Rail – Alignment and SSD Installation

### 6.1.2.1 Front Drive Bay LED Support

Each drive bay includes two LED indicators, green for drive activity and amber for drive status. Light pipes are integrated into the drive mounting rail. The pipes direct light emitted from LEDs mounted next to each drive connector on the backplane to the drive front bay. The pipes make the LEDs visible from the front of the system.

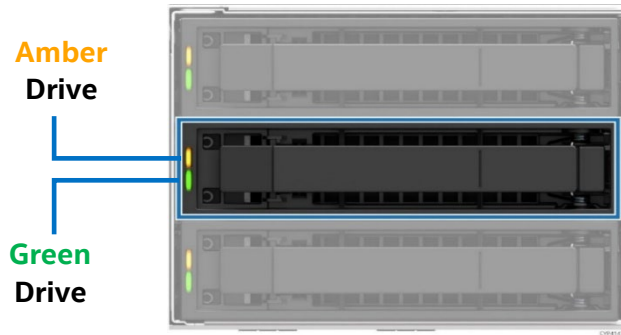


Figure 67. 3.5" Front Drive LED Identification

Table 31. 3.5" Front Drive Amber Status LED States

	LED State	Drive Status
Amber	Off	No access and no fault
	Solid on	Hard drive fault has occurred
	1 Hz blinking	RAID rebuild in progress
	2 Hz blinking	Locate (identify)

Table 32. 3.5" Front Drive Green Activity LED States

	Condition	Drive Type	LED Behavior
Green	Power on with no drive activity	SAS/NVMe*	LED stays on
		SATA	LED stays off
	Power on with drive activity	SAS/NVMe*	LED blinks off when processing a command
		SATA	LED blinks on when processing a command
	Power on and drive spun down	SAS/NVMe*	LED stays off
		SATA	LED stays off

	Power on and drive spinning up	SAS/NVMe*	LED blinks
		SATA	LED stays off

**Note:** The drive activity LED is driven by signals from the drive itself. Drive vendors may choose to operate the activity LED different from what is described in the above tables. If the activity LED on a given drive type behaves differently than what is described, customers should reference the drive vendor specifications. Obtain the specific drive model to determine the expected drive activity LED operation.

## 6.2 Hot-Swap Backplane (HSBP) Overview

The front drive bay of the server system may have support for either 2.5" or 3.5" drives. Each 2.5" or 3.5" system configuration has a backplane to support the chosen drive configuration. The following sections describe backplane features and available backplane options.

All backplanes support the following features:

- Up to 64 Gb/s NVMe, 22.5 Gb/s SAS, and 6 Gb/s SATA support
- Hot-swap drive support
- Cable connectors
  - SFF-8643 miniSAS HD connector: 22.5 Gb/s SAS capable
  - PCIe SlimSAS connector
  - 1x5-pin connector: I<sup>2</sup>C interface for device status communication to the BMC over SMBus
  - 2x2-pin connector: power
- SGPIO SFF-8485 interface embedded within the sideband of the miniSAS HD connectors
- HSBP microcontroller: Cypress\* CY8C22545-24AXI PSoC\* Programmable System-on-Chip device
- LEDs to indicate drive activity and status for each attached device
- Device presence detect inputs to the microcontroller
- 5 V voltage regulator (VR) for devices
- 3.3 V voltage regulator (VR) for microcontroller
- Microcontroller firmware updateable over the I<sup>2</sup>C interface
- Field Replaceable Unit (FRU) EEPROM support
- Temperature sensor using a TMP75 (or equivalent) thermistor implementation with the microcontroller

### 6.2.1 SGPIO Functionality

Backplanes include support for an SFF-8485 compliant SGPIO interface used to activate the status LED. This interface is also monitored by the microcontroller for changing values of FAULT, IDENTIFY, and REBUILD registers. These items, in turn, are monitored by the server board BMC for generating corresponding System Event Log (SEL) events.

### 6.2.2 I<sup>2</sup>C Functionality

The microcontroller has a host/target I<sup>2</sup>C connection to the server board BMC. The microcontroller is not an Intelligent Platform Management Bus (IPMB) compliant device. The BMC generates SEL events by monitoring registers on the HSBP microcontroller for DRIVE PRESENCE, FAULT, and RAID REBUILD in progress.

**Table 33. I<sup>2</sup>C Cable Connector Pinout**

Pin #	Signal Name
1	SMB_3V3_DAT
2	GND
3	SMB_3V3_CLK
4	SMB_ADD0
5	SMB_ADD1

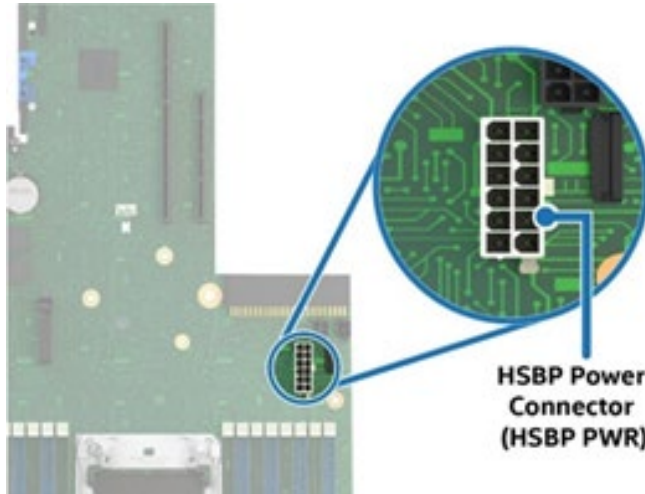
### 6.2.3 HSBP Power

All backplanes include a 2x2 pin cable connector used to supply power to the backplane.

**Table 34. Power Connector Pinout**

Pin #	Signal Name
1	GND
2	GND
3	P12V
4	P12V

Power for all backplanes is drawn from the power connector on the server board labeled “HSBP\_PWR”. Appropriate power cables to support the backplane are included with the system and the backplane accessory kit.

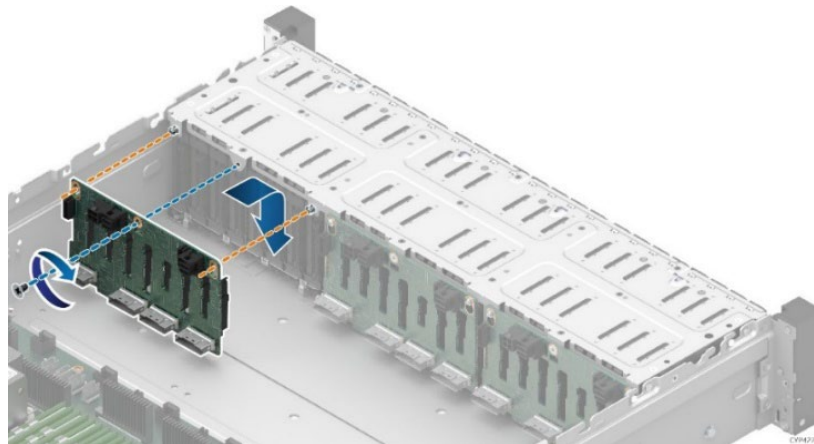


**Figure 68. Server Board HSBP Power Connector**

### 6.2.4 8 X 2.5" Backplane (iPC CYPHSBP2208)

For server systems that support 2.5" front drive bays, up to three 8 x 2.5" backplanes can be installed to support 8, 16, or 24 drive configurations.

All 8 x 2.5" drive backplanes are mounted to the back of the drive bay as shown in the following figure.



**Figure 69. 2.5" Backplane Placement**

Each installed backplane has support for up to eight 2.5" SSD drives with the following specifications; up to 22.5 Gb/s SAS drives, 6 Gb/s SATA drives, and 64 Gb/s U.2 SFF NVMe drives. Configurations include SAS or SATA only, NVMe only, or a combination of both SAS and NVMe drives.

Thermal guidelines for the system require that backplanes be installed in a specific configuration depending on the number of backplanes installed.

- One 8 x 2.5" Backplane – Center Bay (Bay 2)
- Two 8 x 2.5" Backplanes – Left and Right Bays (Bay 1 and Bay 3)
- Three 8 X 2.5" Backplanes – All bays (Bay 1, Bay 2, and Bay 3)



**Figure 70. 8 x 2.5" Front Bay Drive Configuration – M50FCP2UR208**



**Figure 71. 16 x 2.5" Front Bay Drive Configuration – M50FCP2UR208 with accessory options**



**Figure 72. 24 x 2.5" Front Bay Drive Configuration – M50FCP2UR208 with accessory options**

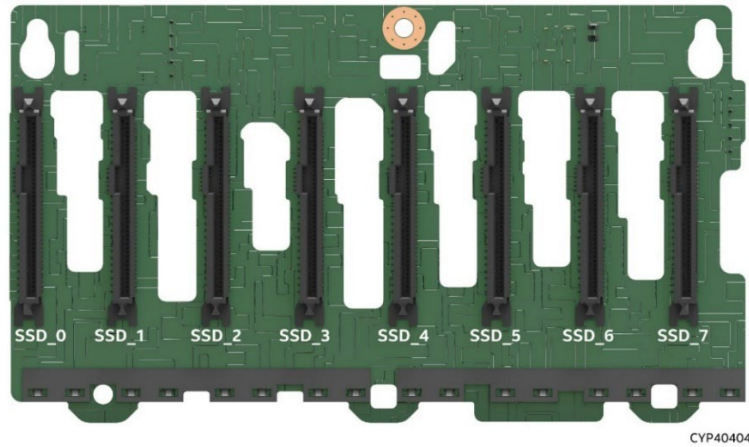
---

Note: Upgrading an 8 drive system to a 16 drive system requires moving the original backplane to one of the outer bay locations, and installing the 2<sup>nd</sup> backplane to the opposite outer bay location.

---

The front side of the backplane includes eight 68-pin SFF-8639 drive interface (U.2) connectors, each capable of supporting SAS, SATA, or NVMe drives. The connectors are labeled **SSD\_0** through **SSD\_7**.





**Figure 73. 8 x 2.5" SAS/SATA/NVMe\* Hot-Swap Backplane – Front Side**

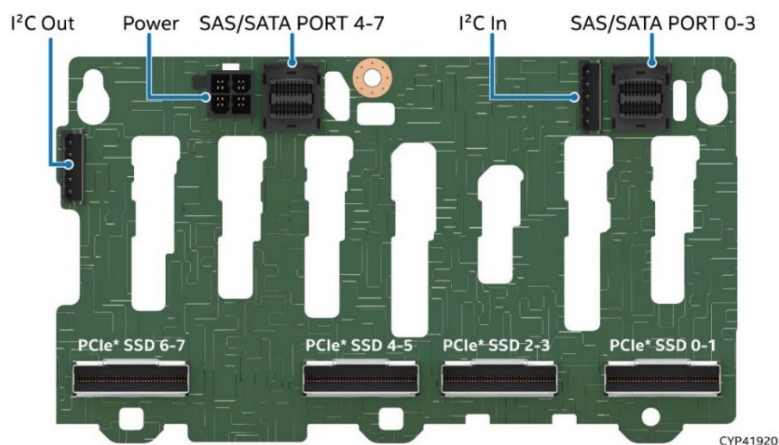
To support both SATA/SAS data signals and PCIe Bus lanes for NVMe drives, the backside of the backplane must include different types of cable connectors to support each drive type:

- Mini-SAS HD for SATA/SAS
- SlimSAS for NVMe.

In support of SATA/SAS drives, the backside of the backplane includes two 4-port Mini-SAS HD cable connectors. Each connector provides SGPIO and I/O data signals to four drive connectors on the frontside of the backplane. These cable connectors are labeled "**SAS/SATA Port 0-3**" and "**SAS/SATA Port 4-7**". For SATA only support, input cables can be routed from matching connectors on the server board. For SAS only or for SAS/SATA RAID support, input cables can be routed from optional PCIe add-in SAS HBA or RAID cards.

In support of PCIe NVMe drives, the backside of the backplane includes four SlimSAS cable connectors. Each cable connector supports X8 PCIe bus lanes in support of two drive connectors on the frontside of the backplane. The SlimSAS connectors are labeled "**PCIe SSD 0-1**" ..... "**PCIe SSD 6-7**". Each NVMe drive connected to the frontside of the backplane is supported by X4 PCIe bus lanes. PCIe bus lanes to the backplane can be routed from any of the following sources:

- Available server board PCIe MCIO connectors
- NVMe riser card with PCIe SlimSAS connectors
- Optional tri-mode RAID add-in card

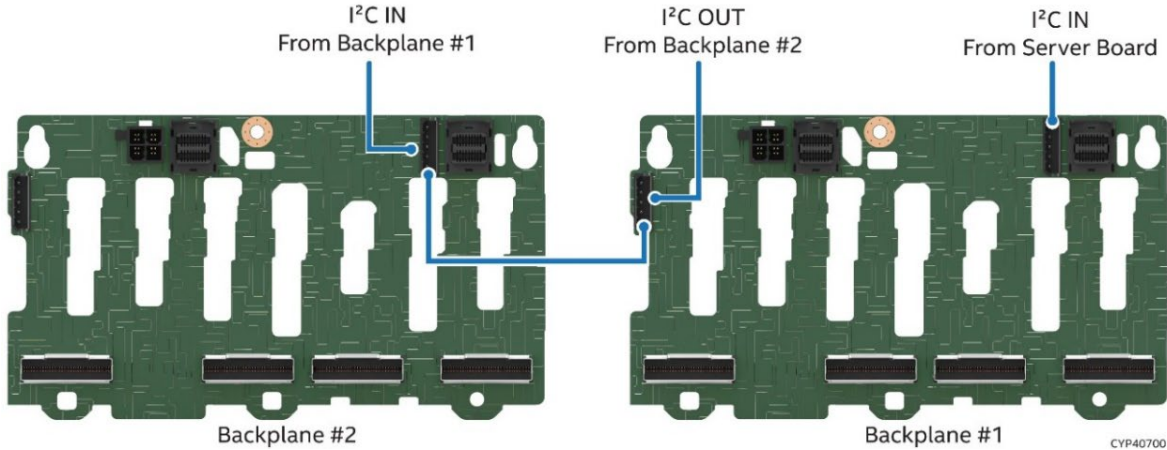


**Figure 74. 8 x 2.5" SAS/SATA/NVMe\* Hot-Swap Backplane – Back Side**

#### 6.2.4.1 I<sup>2</sup>C Cable Connectors

The backplane includes two 1x5 pin cable connectors (labeled I2C\_IN and I2C\_OUT) used as a management interface between the backplane and server board. In systems configured with multiple

backplanes, a short jumper cable is attached between backplanes, extending the SMBus to each installed backplane as shown in the following figure.



**Figure 75. Connecting Two x8 Backplanes**

### 6.2.5 12 X 3.5" Backplane (iPC CYPHSBP2312)

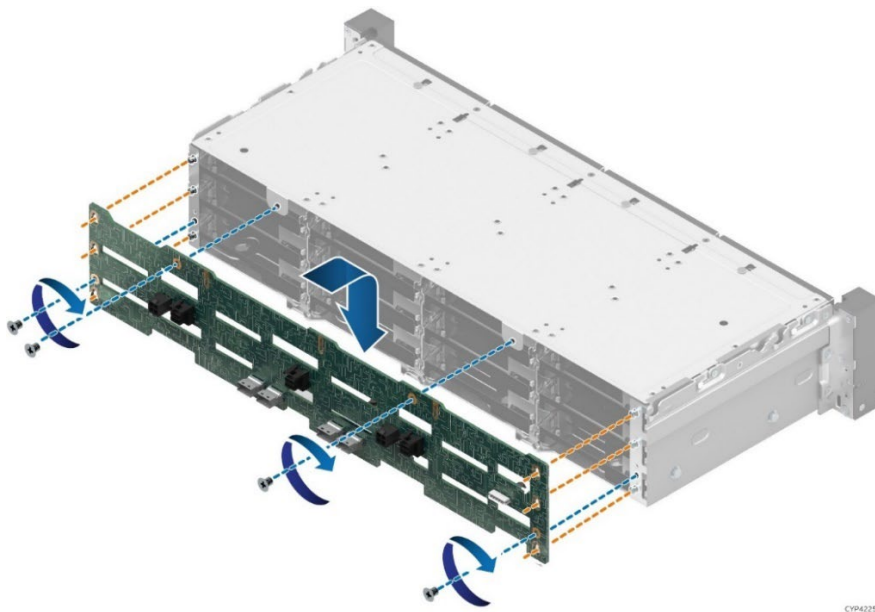
For server systems that include twelve 3.5" front drive bays, the following drive form factors are supported::

- 3.5" hard drives
- 2.5" SSDs using the included drive blank as a 2.5" drive mounting bracket. See [Section 0](#)

Drive technologies supported include:

- 6 Gb/s SATA
- 22.5 Gb/s SAS
- 64 Gb/s PCIe NVMe (up to 4 drives)

A single 12 X 3.5" backplane is mounted to the back of the drive bay as shown in the following figure.



**Figure 76. 3.5" Backplane Placement**

The system supports the following drive configurations.

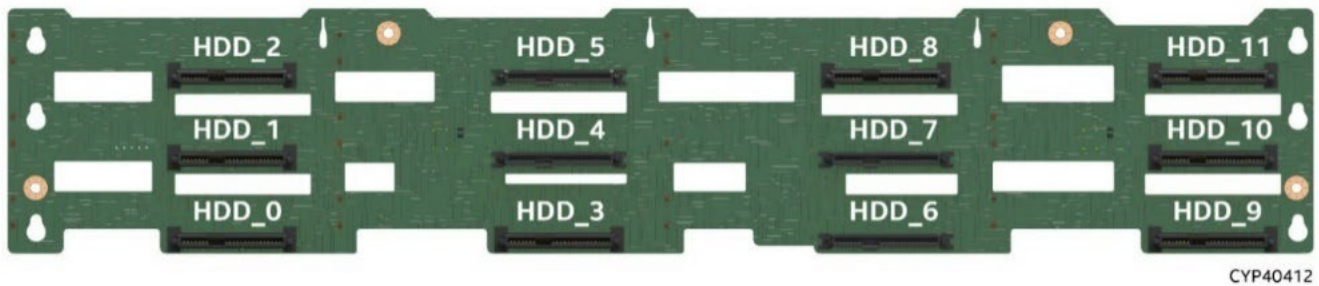
- Up to 12 SAS/SATA SSD/HDD drives
- Up to 8 SAS/SATA SSD/HDD drives and up to four NVMe SSD drives

While all drive bays support SATA and SAS drives, only drive bays 4, 5, 6, and 7 can be used to support PCIe NVMe\* SSDs.



**Figure 77. 12 x 3.5" Front Bay Drive Configuration – M50FCP2UR312**

Mounted on the front side of the backplane are eight 29-pin (SFF-8680) SAS/SATA drive connectors supporting SAS/SATA drives only (labeled **HDD\_0** through **HDD\_3** and **HDD\_8** through **HDD\_11**). Four 68-pin (SFF-8639) drive connectors (labeled **HDD\_4** through **HDD\_7**) have support for SAS/SATA and NVMe drives



**Figure 78. 12 x 3.5" HSBP Connector Identification – Front Side**

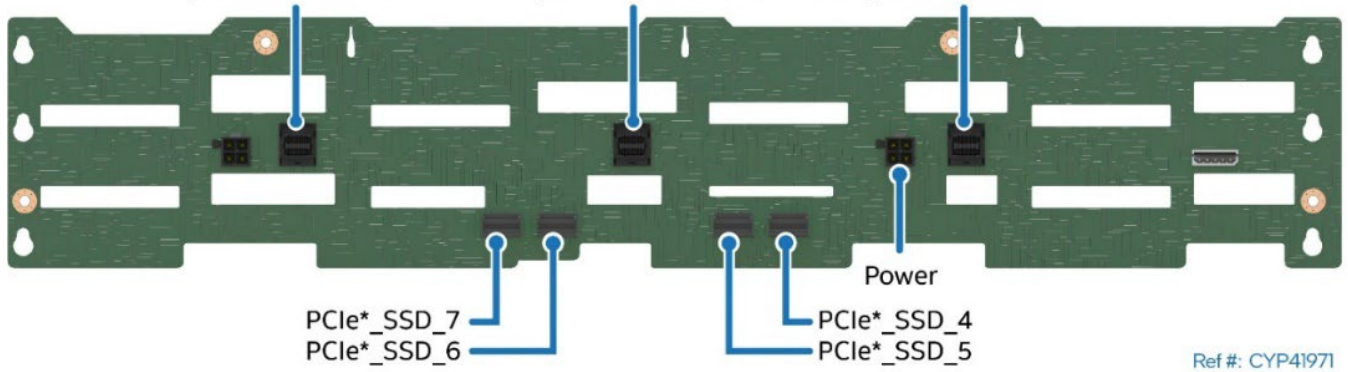
To support both SATA/SAS data signals and PCIe Bus lanes for NVMe drives, the backside of the backplane must include different types of cable connectors to support each drive type:

- Mini-SAS HD for SATA/SAS
- SlimSAS for NVMe.

In support of SATA/SAS drives, the backside of the backplane includes three 4-port Mini-SAS HD cable connectors. Each connector provides SGPIO and I/O data signals to four drive connectors on the frontside of the backplane. These cable connectors are labeled “**SAS/SATA Port 0–3**”, “**SAS/SATA Port 4–7**”, and “**SAS/SATA Port 8–11**”. For SATA only support, input cables can be routed from matching connectors on the server board. For SAS only or for SAS/SATA RAID support, input cables can be routed from optional PCIe add-in SAS HBA or RAID cards.

In support of PCIe NVMe drives, the backside of the backplane includes four SlimSAS cable connectors. Each cable connector supports X4 PCIe bus lanes in support of one drive connector on the frontside of the backplane. The SlimSAS connectors are labeled “**PCIe SSD 4**” ..... “**PCIe SSD 7**”. Each NVMe drive connected to the frontside of the backplane is supported by X4 PCIe bus lanes. PCIe bus lanes to the backplane can be routed from any of the following sources:

- Available server board PCIe MCIO connectors
- NVMe riser card with PCIe SlimSAS connectors
- Optional tri-mode RAID add-in card



**Figure 79. 12 x 3.5" HSBP Connector Identification – Back Side**

### 6.3 NVMe\* Storage Support

The Intel® Server M50FCP2UR family provides many front drive bay configuration options in support of U.2 PCIe NVMe SSDs. PCIe bus signals to the backplane can be cabled from multiple PCIe source options:

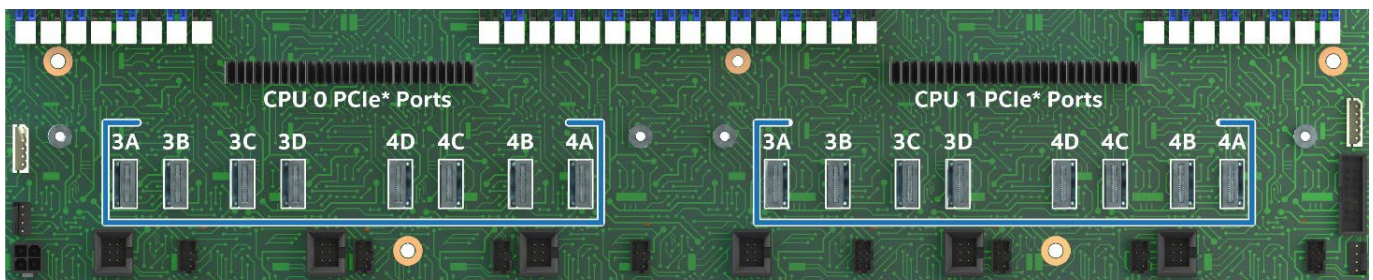
- Sixteen onboard x4 PCIe MCIO cable connectors
- Riser #1 and Riser #3 NVMe riser cards options – iPC **FCP2URISER1RTM** & iPC **CYPRISER3RTM**
- Optional tri-mode RAID add-in card

The following sections provide an overview for each option.

#### 6.3.1 NVMe Support from the Server Board

The server board within the Intel® Server System M50FCP2U includes sixteen PCIe Mini Cool Edge IO (MCIO\*) cable connectors. MCIO is a next generation ultra-high-speed interconnect solution for server boards and storage devices. Each MCIO cable connector supplies X4 PCIe bus lanes for a PCIe NVMe drive when cabled to a backplane.

X32 PCIe bus lanes from each installed processor are routed to a set of eight PCIe MCIO connectors (See the PCIe Architectural Diagram in [Figure 40](#)). Each MCIO cable connector on the server board is label according to the processor supplying the PCIe bus lanes, and the PCIe port from the specified processor (See [Figure 80](#)).



Ref #: FCP10091

Figure 80. PCIe\* MCIO Connectors

#### 6.3.2 PCIe\* NVMe\* Riser Card Options

The server system supports two NVMe riser card options as described in the following subsections.

##### 6.3.2.1 PCIe\* NVMe\* Riser Card for Riser Slot #3 (iPC CYPRISER3RTM)

The riser slot #3 PCIe NVMe riser card option supports two x8 PCIe SlimSAS cable connectors labeled **PCIe\_SSD\_0-1** and **PCIe\_SSD\_2-3**. When cable to the backplane, each connector supports up to two NVMe SSDs.



CYP401B2

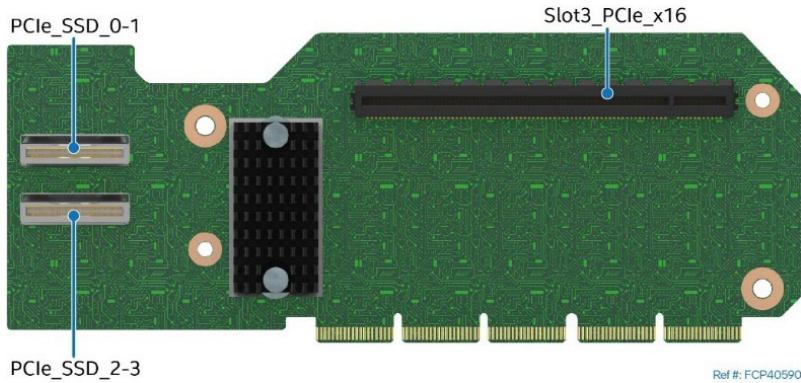
Figure 81. PCIe\* NVMe\* Riser Card for Riser Slot #3

Table 35. PCIe\* NVMe\* Riser Card Connector Description

Connector	Description
PCIe_SSD_0-1	CPU 1: Ports 0C through 0D
PCIe_SSD_2-3	CPU 1: Ports 0A through 0B

**6.3.2.2 PCIe\* NVMe\* Riser Card for Riser Slot #1 (iPC FCP2URISER1RTM)**

The riser slot #1 PCIe NVMe riser card option supports two x8 PCIe SlimSAS cable connectors labeled **PCIe\_SSD\_0-1** and **PCIe\_SSD\_2-3**. When cable to the backplane, each connector supports up to two NVMe SSDs



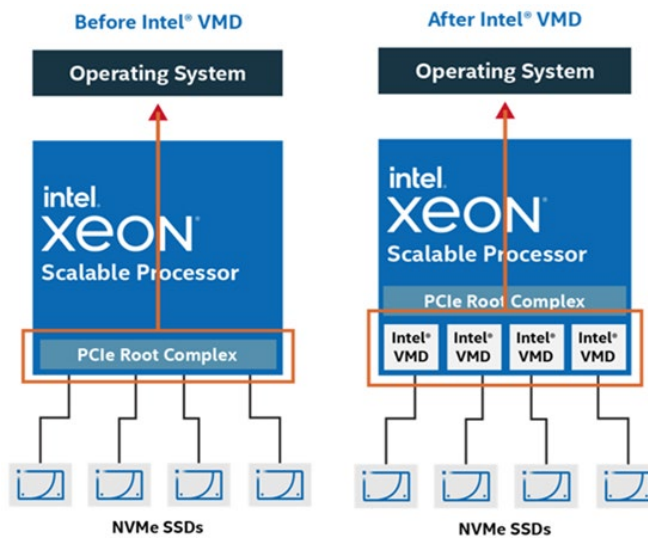
**Figure 82. PCIe\* NVMe\* Riser Card for Riser Slot #1**

**Table 36. PCIe\* NVMe\* Riser Card Connector Description**

Connector	Add-in Card Slot Description	PCIe Port Mapping	Maximum Available Power (W)
Slot3_PCl_e_x16	x16 electrical, x16 mechanical	CPU 0 – Ports 1A through 1B	75
PCIe_SSD_0-1	X8 PCIe MCIO cable connector	CPU 0 – Ports 2A through 2B	N/A
PCIe_SSD_2-3	X8 PCIe MCIO cable connector	CPU 0 – Ports 2C through 2D	N/A

**6.3.3 Intel® Volume Management Device (Intel® VMD) 3.0 for NVMe\***

Intel® Volume Management Device (Intel® VMD) is hardware logic inside the processor root complex to help manage PCIe NVMe SSDs. It provides robust hot plug support and status LED management. These features allow servicing of storage system NVMe SSD media without concern of system crashes or hangs when ejecting or inserting NVMe SSD devices on the PCIe bus.



**Figure 83. NVMe\* Storage Bus Event / Error Handling**

Intel® VMD handles the physical management of NVMe storage devices as a stand-alone function but can be enhanced when Intel® Virtual RAID on CPU (Intel® VROC) support options are enabled to implement RAID-based storage systems.

Intel® VMD 3.0 includes the following features and capabilities:

- Hardware is integrated inside the processor PCIe root complex.
- Entire PCIe trees are mapped into their own address spaces (domains).
- Each domain manages x16 PCIe lanes.
- Can be enabled/disabled through the <F2> BIOS setup utility at x4 lane granularity.
- OS Embedded driver sets up/manages the domain (enumerate, event/error handling).
- Hot plug support - hot insert array of PCIe NVMe SSDs.
- Support for PCIe NVMe SSDs only. No network interface controllers (NICs), graphics cards, etc.
- Maximum of 128 PCIe bus numbers per domain.
- Support for Management Component Transport Protocol (MCTP) over SMBus only.
- Support for MMIO only (no port mapped I/O).
- Does not support NTB, Intel® QuickData Technology, Intel® Omni-Path Architecture (Intel® OPA), or SR-IOV.
- Correctable errors do not bring down the system.
- Intel® VMD only manages devices on PCIe lanes routed directly from the processor or chipset PCH.
- When VMD is enabled, the BIOS does not enumerate devices that are behind Intel® VMD. The OS embedded Intel® VMD-enabled driver is responsible for enumerating these devices and exposing them to the host.

### 6.3.3.1 Enabling Intel® VMD for NVMe\* Support

For installed NVMe devices to use the Intel VMD features in the system, Intel VMD must be enabled on the appropriate processor PCIe root ports in the <F2> BIOS setup utility. By default, Intel VMD support is disabled on all processor PCIe\* root ports. To enable Intel VMD support on the appropriate CPU PCIe root port, navigate to **Advanced > PCI Configuration > Volume Management Device** in the <F2> BIOS Setup menu

---

**Note:** PCIe root ports should only be enabled for PCIe MCIO connectors supporting NVMe devices. PCIe root ports supporting other Non-NVMe PCIe devices should remain in their default disabled setting.

---

The following tables provides the PCIe port routing information for the server board PCIe MCIO connectors and NVMe riser card options.

**Table 37. CPU PCIe Port Mapping for NVMe Connectivity – MCIO Connector & Riser Card Options**

Host	Port	Width	Gen.	Usage
CPU 0	Port 0A–0D	x16	4.0	OCP* Adapter connector
	Port 1A–1D	x16	5.0	Riser Slot #1 [15:0]
	Port 2A–2D	x16	5.0	Riser Slot #1 [31:16] – NVMe Riser Card option
	Port 3A–3D	x16	5.0	Server board PCIe MCIO connectors
	Port 4A–4D	x16	5.0	Server board PCIe MCIO connectors
	DMI3	x8	3.0	Chipset PCH
CPU 1	Port 0A–0D	x16	5.0	Riser Slot #3 [15:0] – NVMe Riser Card option
	Port 1A–1D	x16	5.0	Riser Slot #2 [31:16]
	Port 2A–2D	x16	5.0	Riser Slot #2 [15:0]
	Port 3A–3D	x16	5.0	Server board PCIe MCIO connectors
	Port 4A–4D	x16	5.0	Server board PCIe MCIO connectors

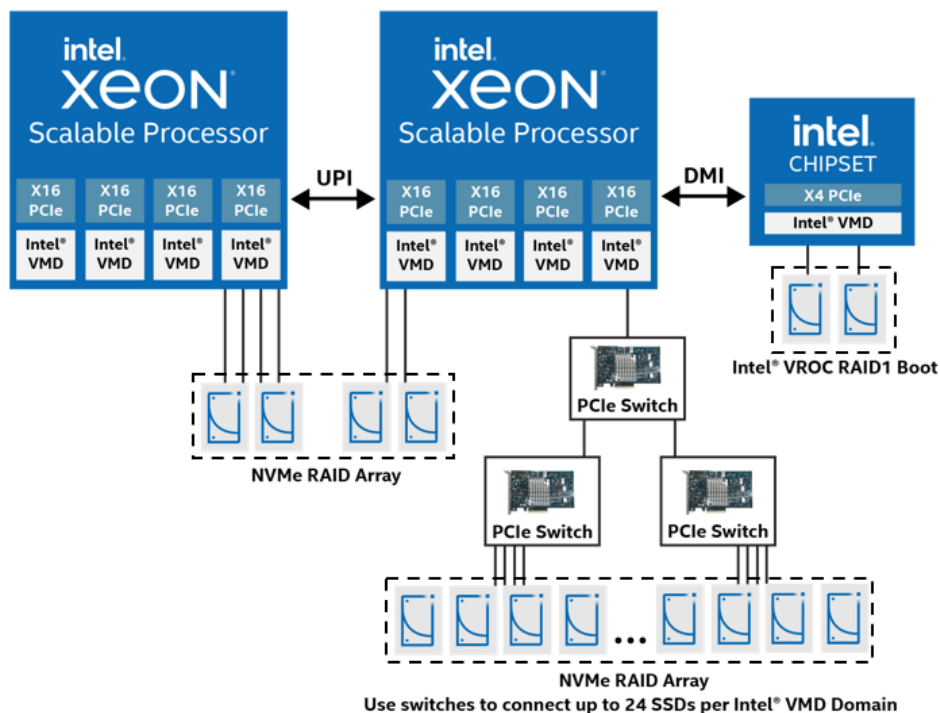
**Table 38. CPU to PCIe\* MCIO Connector Routing**

Host	CPU Port	Routed to MCIO Connector
CPU 0	Port 3A	CPU0_PCl_e_Port3A
	Port 3B	CPU0_PCl_e_Port3B
	Port 3C	CPU0_PCl_e_Port3C
	Port 3D	CPU0_PCl_e_Port3D
	Port 4D	CPU0_PCl_e_Port4D
	Port 4C	CPU0_PCl_e_Port4C
	Port 4B	CPU0_PCl_e_Port4B
	Port 4A	CPU0_PCl_e_Port4A
CPU 1	Port 3A	CPU1_PCl_e_Port3A
	Port 3B	CPU1_PCl_e_Port3B
	Port 3C	CPU1_PCl_e_Port3C
	Port 3D	CPU1_PCl_e_Port3D
	Port 4D	CPU1_PCl_e_Port4D
	Port 4C	CPU1_PCl_e_Port4C
	Port 4B	CPU1_PCl_e_Port4B
	Port 4A	CPU1_PCl_e_Port4A

### 6.3.4 Intel® Virtual RAID on CPU for NVMe (Intel® VROC for NVMe) 8.0

The Intel® Server M50FCP family uses embedded Intel® Virtual RAID on CPU for NVMe (Intel® VROC for NVMe) 8.0 technology to provide RAID support for both Intel and non-Intel NVMe SSDs interfaced through the onboard PCIe MCIO connectors.

Intel® VROC for NVMe is an enterprise RAID solution that unleashes the performance of NVMe SSDs. Intel® VROC is enabled by a feature embedded within Intel® Xeon® Scalable processors called Intel® Volume Management Device (Intel® VMD), an integrated controller inside the CPU PCIe root complex. NVMe SSDs interfaced using any of the onboard PCIe MCIO connectors are directly supported by the CPU, allowing the full performance potential of fast storage devices to be realized.



**Figure 84. Supported NVMe\* Configurations – Windows\* and Linux\***



Intel® VROC is a complete RAID solution, including:

- High performance due to direct connect of SSDs
- Platform integrated storage controller functions provided by Intel® VMD
- Boot and Data RAID
- Scalable to many devices and RAID arrays
- Support for SATA, Intel® VMD NVMe RAID, and non-Intel® VMD NVMe RAID

Intel offers two Intel® VROC for NVMe License Activation key options, Standard and Premium. See [Table 39](#) for option details.

An Intel® VROC for NVMe License Activation key is a software key that can be pre-loaded onto the system by Intel when ordering a fully integrated L9 server system using Intel's online Configure-to-Order (CTO) tool, or it can be purchased separately from the system and installed later using the system's Integrated BMC Web Console, Redfish\* API, or the Intel® Server Configuration utility. Full installation instructions are provided when the activation license key is ordered separately.

---

**Note:** See [Appendix B Software License Key Order, Registration, and Installation](#) for more information.

---

Supported features for available Intel® VROC for NVMe License Activation keys are shown in the following table.

**Table 39. Intel® VROC for NVMe Activation License Key – Supported NVMe\* RAID Features**

NVMe* RAID Major Features	Standard Intel® VROC Key (iPC VROCSTANKEY)	Premium Intel® VROC Key (iPC VROCPREMKEY)
Processor-attached NVMe* SSD: high performance	Yes	Yes
Bootable on RAID volume	Yes	Yes
Third party vendor SSD support	Yes	Yes
RAID 0/1/10	Yes	Yes
RAID 5	No	Yes
RAID write hole closed (RMFBU replacement)	No	Yes
Hot plug/ surprise removal (2.5" SSD form factor only)	Yes	Yes
Enclosure LED management	Yes	Yes

### 6.3.5 NVMe\* Drive Population Rules for Intel® VROC 8.0

When installing NVMe drives into a backplane, specific drive population rules must be followed. Explicit cabling from a PCIe source to the backplane must be used to support population rules.

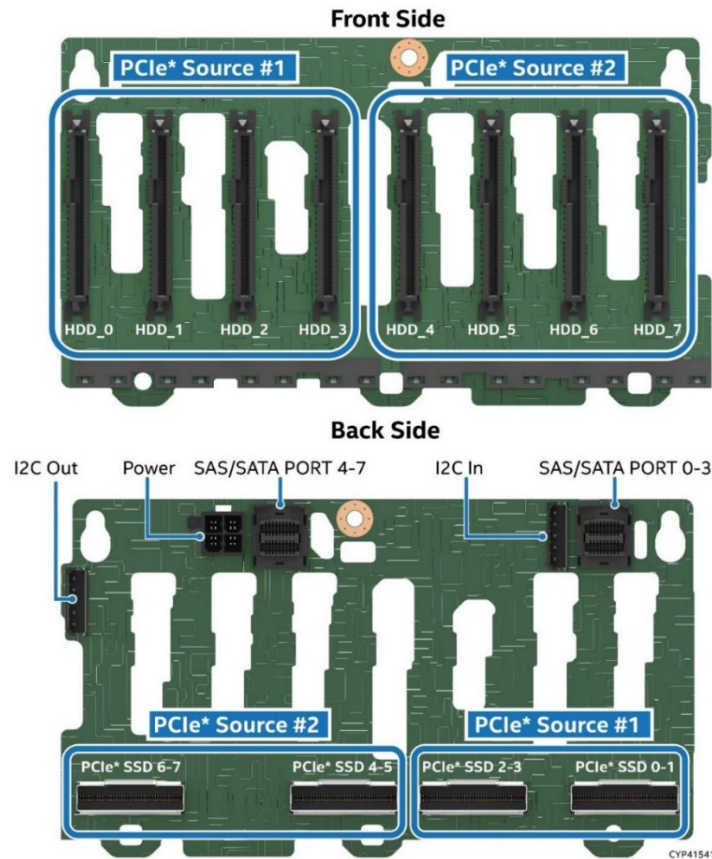
The backplane supports PCIe interfaces from the following sources:

- Server board PCIe MCIO cable connectors
- Optional PCIe NVMe riser card options in Riser Slot #1 and/or Riser Slot #3
- Optional tri-mode Intel® RAID add-in cards

### 6.3.5.1 Server Board PCIe\* MCIO Connectors and/or PCIe\* NVMe\* Riser Cards and/or Tri-Mode Intel® RAID Module to 8 x 2.5" Combo Backplane

When cabling the PCIe interfaces from two different sources to the backplane, the cables from each source must be connected in defined drive sets of four, (0-3) or (4-7), as shown in the following figure.

Combining an NVMe drive with a SAS/SATA drive within a defined drive set is not supported.



**Figure 85. Backplane Cabling from Two Backplane Sources**

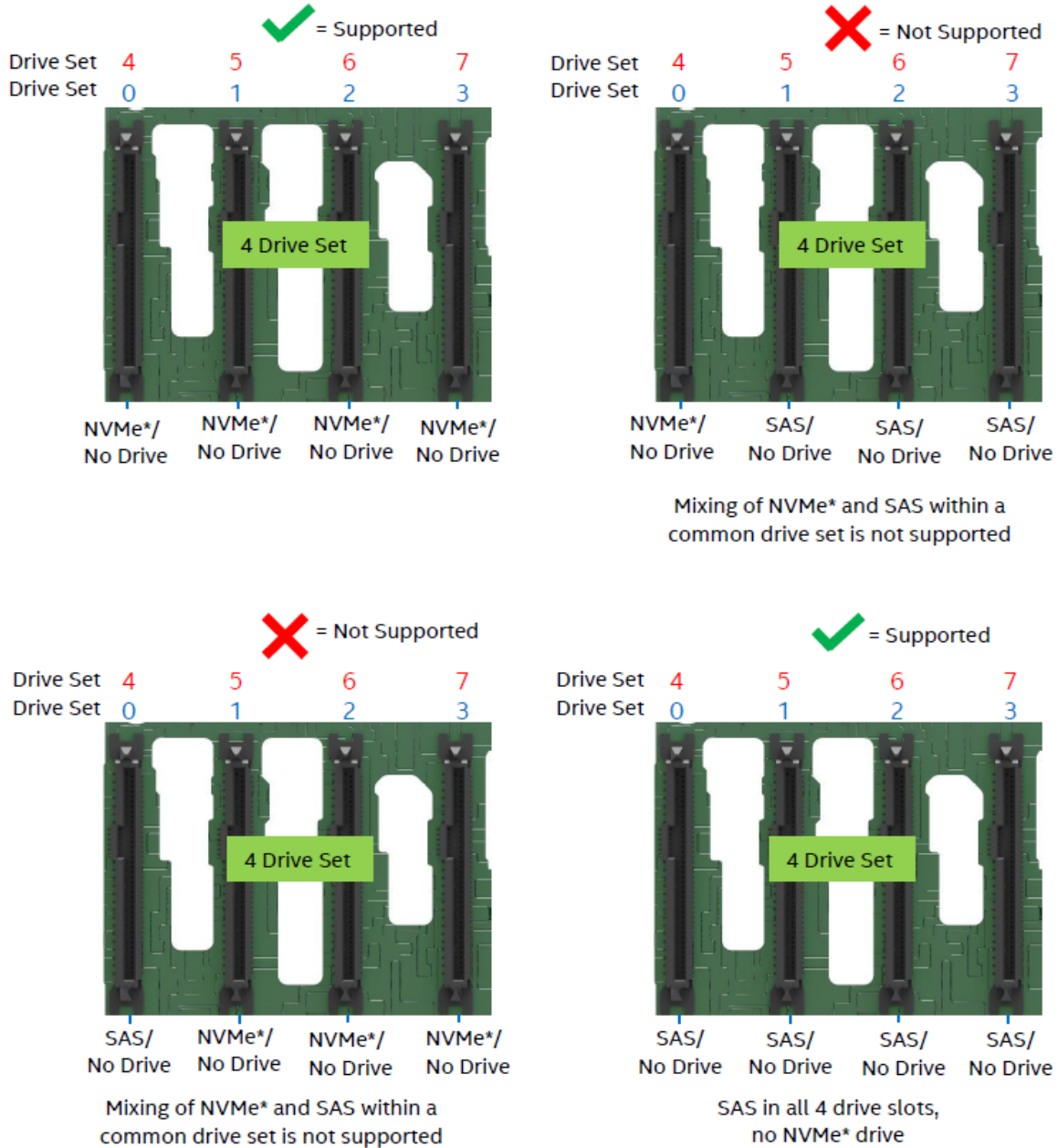
Drive population rules can differ depending on the source of the PCIe interface to the backplane. In addition, specific drive population limits exist when populating a backplane with both NVMe and SAS drive types. The following sections define the drive population rules associated with each of the available PCIe sources to the backplane.

---

**Note:** When connecting the backplane to two different PCIe\* sources, the defined population rules for each PCIe\* source are applied to the drive set connected to it.

---

Figure 86 identifies supported and unsupported drive populations associated with any defined drive pair of the 8 x 2.5" combo backplane.



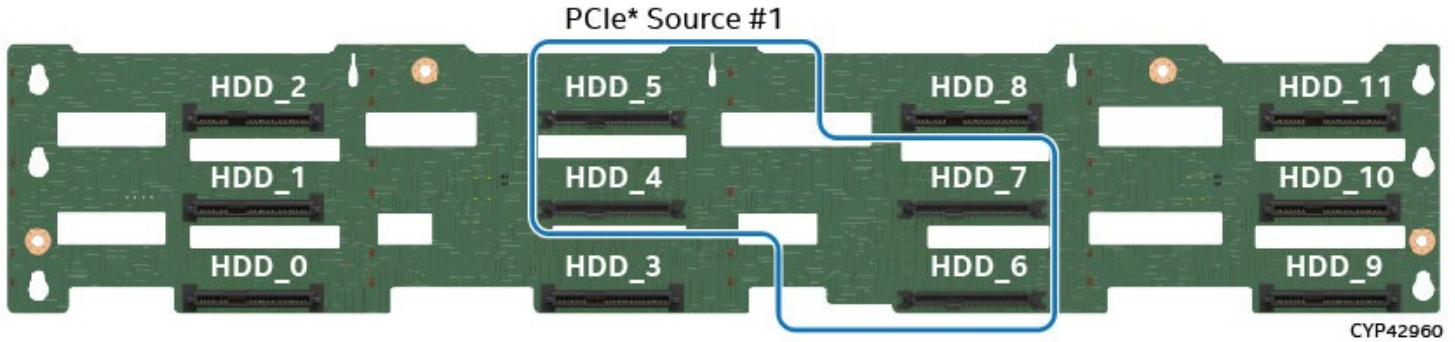
**Figure 86. Supported Drive Population for Server Board MCIO Connectors or Tri-Mode Intel® RAID Module**

**Note:** The NVMe\* drive population rules defined above are only applicable when the Intel® VROC 8.0 accessory option is installed and used to provide NVMe\* RAID 1/5/10 management.

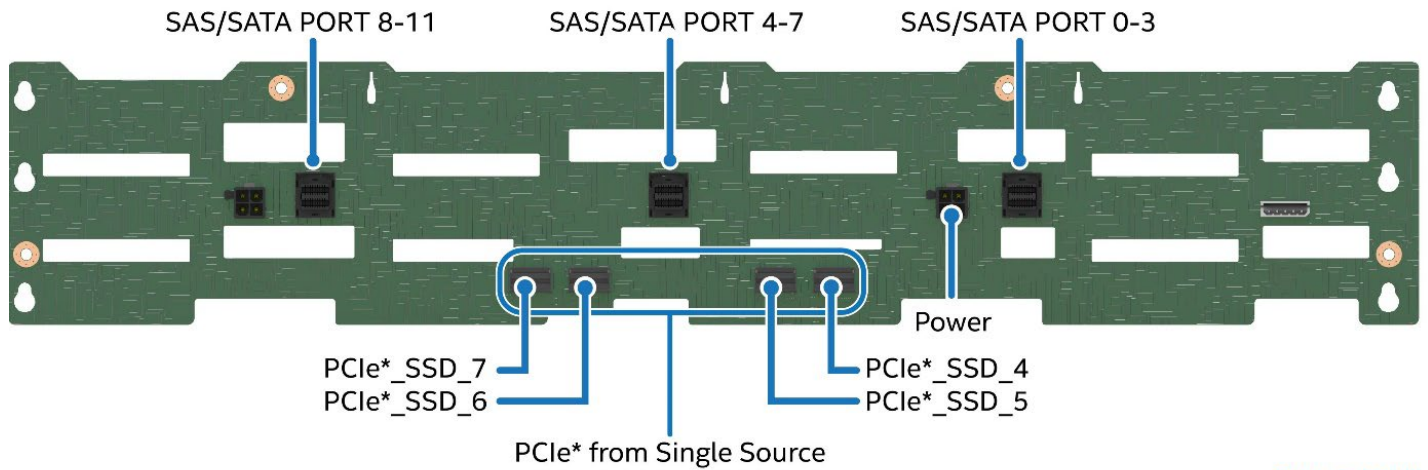
**6.3.5.2 Server Board PCIe\* MCI/O Connectors and/or PCIe\* NVMe\* Riser Cards and/or Tri-Mode Intel® RAID Module to 12 x 3.5" Combo Backplane**

When cabling a PCIe interface source to the backplane, the cable must be only connected to the drive set highlighted in the following figure.

This backplane does not support PCI interface from multiple PCIe sources. Combining an NVMe drive with a SAS/SATA drive within a defined drive set is not supported.



**Figure 87. 12 x 3.5" HSBP NVMe\* Connector Identification – Front Side**



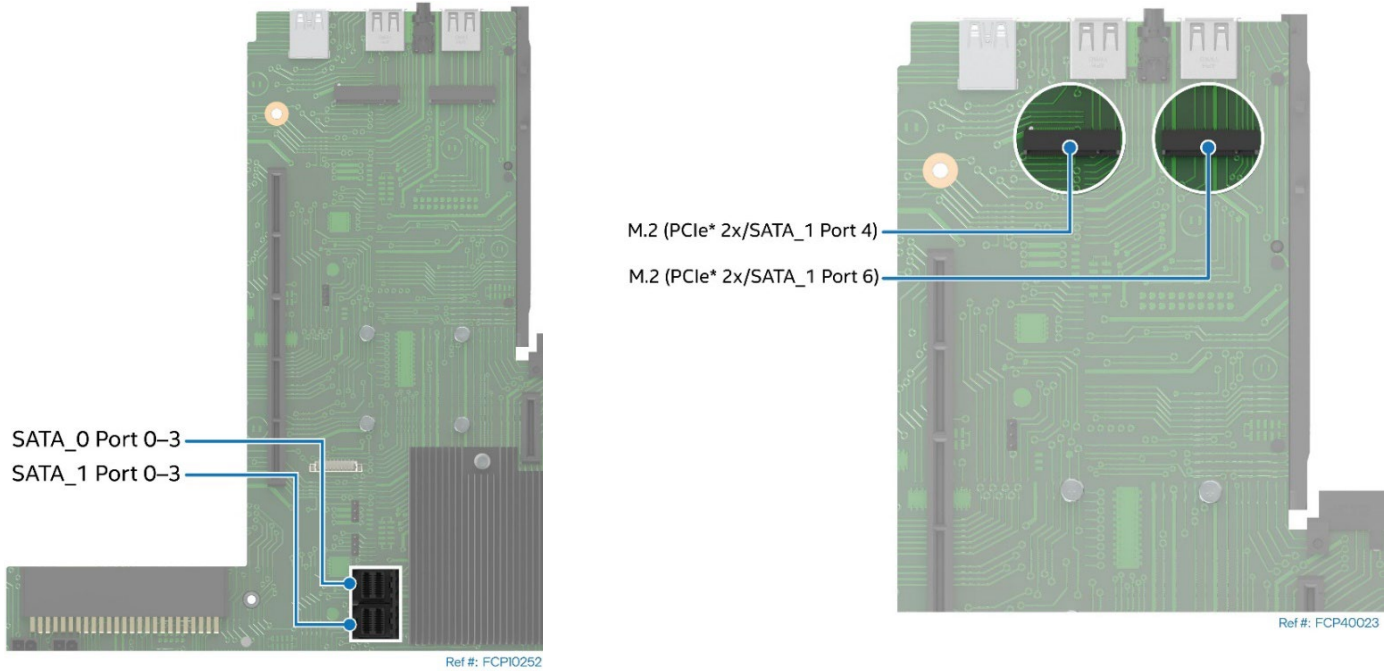
Ref #: CYP42911

**Figure 88. 12 x 3.5" HSBP Connector Identification – Back Side**

## 6.4 Onboard SATA Support

The server board includes two Intel chipset embedded AHCI SATA controllers, identified as “SATA\_0” and “SATA\_1”. Each SATA controller supports 6 GB/s SATA 3.0 ports. SATA ports from each controller are routed to connectors on the server board as follows:

- SATA\_0 ports 0–3 are routed to one SFF-8643 Mini-SAS HD cable connector
- SATA\_1 ports 0–3 are routed to one SDD-8643 Mini-SAS HD cable connector
- SATA\_1 ports 4 and 6 are routed to two M.2 SSD connectors



**Figure 89. Onboard SATA Cable Connectors and M.2 SSD Connectors**

The following table describes the SATA\_0 and SATA\_1 controller feature support.

**Table 40. SATA\_0 and SATA\_1 Controller Feature Support**

Feature	Description	AHCI Mode	RAID Mode Intel® VROC (SATA RAID)
<b>Native Command Queuing (NCQ)</b>	Allows the device to reorder commands for more efficient data transfers	Supported	Supported
<b>Auto Activate for direct memory access (DMA)</b>	Collapses a DMA Setup, then DMA Activate sequence into a DMA Setup only	Supported	Supported
<b>Hot Plug Support (U.2 Drives Only)</b>	Allows for device detection without power being applied and ability to connect and disconnect devices without prior notification to the system	Supported	Supported
<b>Asynchronous Signal Recovery</b>	Provides a recovery from a loss of signal or establishing communication after hot plug	Supported	Supported
<b>6 Gb/s Transfer Rate</b>	Capable of data transfers up to 6 Gb/s	Supported	Supported
<b>ATAPI Asynchronous Notification</b>	A mechanism for a device to send a notification to the host that the device requires attention	Supported	Supported

Feature	Description	AHCI Mode	RAID Mode Intel® VROC (SATA RAID)
<b>Host and Link Initiated Power Management</b>	Capability for the host controller or device to request Partial and Slumber interface power states	Supported	Supported
<b>Staggered Spin-Up</b>	Enables the host the ability to spin up hard drives sequentially to prevent power load problems on boot	Supported	Supported
<b>Command Completion Coalescing</b>	Reduces interrupt and completion overhead by allowing a specified number of commands to complete and then generating an interrupt to process the commands	Supported	N/A

The SATA\_0 controller and the SATA\_1 controller can be independently configured using the <F2> BIOS setup utility to function in AHCI mode or disabled.

### 6.4.1 Staggered Disk Spin-Up

A high number of hard drives with spinning media can be attached to the onboard SATA controllers. The combined startup power demand for all attached hard drives can be much higher than the normal running power requirements.

To mitigate the condition and lessen the peak power demand during system startup, both the AHCI SATA controllers implement a Staggered Spin-Up capability for the attached drives. This means that the drives are started up separately, with a certain delay between disk drives starting.

To enable staggered spin-up, go to BIOS setup utility >Mass Storage Controller Configuration screen > **AHCI HDD Staggered Spin-Up**.

### 6.4.2 Intel® Virtual RAID on CPU for SATA (Intel® VROC for SATA)

Intel® VROC SATA provides an embedded enterprise RAID solution for SATA devices connected to the SATA controllers of the Intel® Platform Control Hub (PCH).

By default, onboard RAID options are disabled in BIOS Setup. To enable them, access the BIOS Setup utility by pressing <F2> key during POST. Navigate to the onboard RAID configuration menu: **Advanced > Mass Storage Controller Configuration > sSATA Controller or SATA Controller**.

From the options available in the menu, select the “RAID” mode to enable the RAID support.

---

**Note:** RAID partitions created using Intel® VROC 8.0 cannot span across the two embedded SATA controllers. Only drives attached to a common SATA controller can be included in a RAID partition

---

Supported SATA RAID levels include RAID 0, RAID 1, RAID 5, and RAID 10

- **RAID 0 (striping)** – RAID level 0 combines at least two (up to the maximum number) drives supported by the embedded SATA and sSATA controllers, so that all data is divided into manageable blocks called strips. The strips are distributed across the array members on which the RAID 0 volume resides. Data stored in a RAID 0 volume is not redundant. Therefore, if one drive fails, all data on the volume is lost.
- **RAID 1 (mirroring)** – Data is concurrently written to two drives creating real-time redundancy of all data written to the first drive. This condition is good for small databases or other applications that require small capacity but complete data redundancy. The maximum number of drives supported in a RAID 1 volume is two drives. The RAID 1 volume appears as a single physical drive with a capacity equal to that of the smaller drive.
- **RAID 5 (striping with parity)** – A RAID 5 volume provides the capacity of  $(N - 1) \times$  smallest size of the drives, where  $N \geq 3$  and  $\leq$  maximum number of drives supported by the SATA or sSATA controller. All

data is divided into manageable blocks called strips. RAID 5 also stores parity, a mathematical method for recreating lost data on a single drive. The data and parity are striped across array members. Because of parity, it is possible to rebuild the data after replacing a failed drive with a new one. The maximum number of drives supported in a RAID 5 is the maximum number of drives supported by the platform.

- **RAID 10 (striping and mirroring)** – RAID level 10 uses four drives to create a combination of RAID levels 0 and 1. The data is striped across a two-disk array forming a RAID 0 component. Each of the drives in the RAID 0 array is mirrored to form a RAID 1 component. This condition provides the performance benefits of RAID 0 and the redundancy of RAID 1. The RAID 10 volume appears as a single physical drive with a capacity equal to the two smallest drives of the four-drive configuration. The space on the remaining two drives will be used for mirroring. The maximum number of drives supported in a RAID 10 is four. By using Intel® VROC 8.0, there is no loss of PCIe resources or add-in card slot.

Intel® VROC 8.0 functionality requires the following:

- The embedded RAID option must be enabled in BIOS setup utility.
- Intel® VROC 8.0 option must be selected in BIOS setup utility.
- Intel® VROC 8.0 drivers must be loaded for the installed operating system.
- Up to 16 SATA drives Two SATA drives needed to support RAID levels 1.
- At least three SATA drives needed to support RAID level 5.
- Up to four SATA drives needed to support RAID level 10.
- NVMe SSDs and SATA drives must not be mixed within a single RAID volume.

With Intel® VROC 8.0 software RAID enabled, the following features are made available:

- A boot-time, pre-operating-system environment, text-mode user interface that allows the user to manage the RAID configuration in the system. Its feature set is kept simple to keep its size to a minimum. The user is allowed to create and delete RAID volumes and select recovery options when problems occur. The user interface can be accessed by pressing **<CTRL-I>** during system POST.
- At each boot-up, a status of the RAID volumes provided to the user.

## 6.5 SAS Storage Support

The server system supports front bay SAS/SATA drives using add-cards connected to riser cards. For more information on supported add-in cards, see the *Intel® Server M50FCP Family Configuration Guide*.

## 6.6 M.2 SSD Storage Support

The server board includes two M.2 SSD connectors as shown in the following figure. The connectors are labeled “**M2\_x2PCIe/SATA\_1 Port 4**” and “**M2\_x2PCIe/SATA\_1 Port 6**” on the board. Each M.2 slot supports a PCIe NVMe or SATA drive that conforms to a 22110 (110 mm) or 2280 (80 mm) form factor.

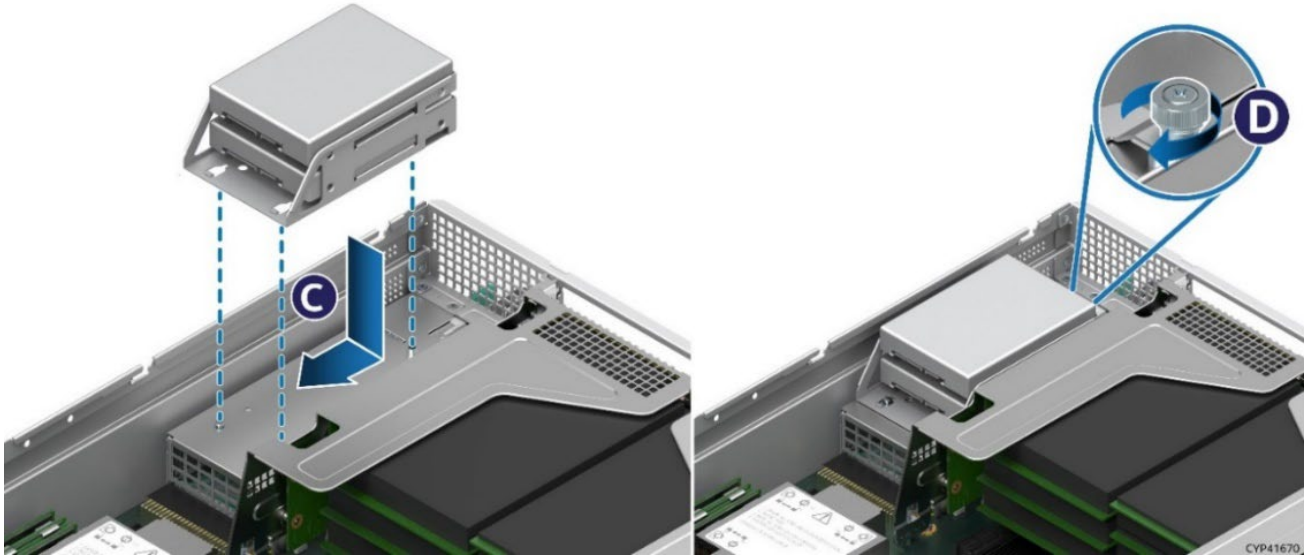
Each M.2 slot is connected to four PCIe 3.0 lanes from the chipset’s embedded controller. The M.2 NVMe drives can be combined into a VROC RAID volume.

## 6.7 Internal Fixed Mount Solid State Drive (SSD) Support

Using Intel Accessory kit **FCPCBLINTSTKIT**, the system can support up to two internal fixed mount 2.5" solid state drives (SSDs). The kit includes:

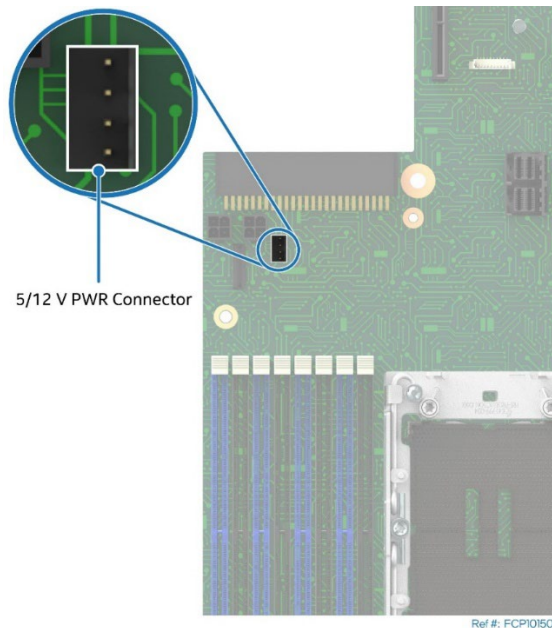
- Internal SATA SSD mounting bracket
- Power cable for internal SATA SSDs
- MiniSAS HD to 7-pin SATA cable

Key holes located on the mounting bracket are positioned over three alignment studs set on top of the Power Supply #2 bay. The bracket is secured by sliding it over the alignment studs and then locked down using a static screw head.



**Figure 90. 2.5" Solid State Drive (SSD) Mounting Option**

A power harness included with the kit is connected between the SSDs and a 1x4 connector on the server board labeled **Peripheral\_PWR**.



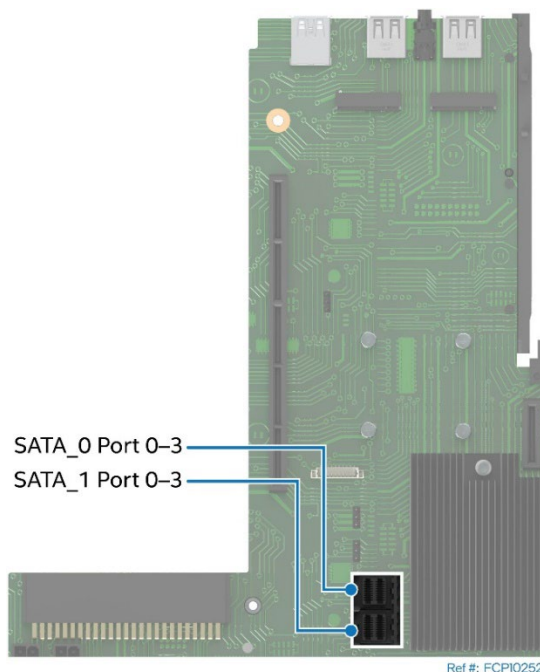
**Figure 91. Peripheral Power Connector Identification**



**Table 41. Peripheral Power Connector Pinout Definition**

Pin #	Signal Name
1	P5V
2	GND
3	GND
4	P12V

Using the SATA cable included with the kit, the SSDs are connected to one of the MiniSAS HD connectors on the server board.

**Figure 92. Onboard SATA Port Connectors**

Internal fixed mount SSDs can only be supported if the selected SATA SSDs do not exceed the following power and thermal limits.

- One or two SATA SSDs supporting up to 6.2 W per device with a case temperature rating of 70 °C
- One or two SATA SSDs supporting up to 2.3 W per device with a case temperature rating of 60 °C

**Notes:**

- **SSDs only.** Installing hard disk drives into the internal drive mounting bracket is not supported. Doing so may cause data loss, performance degradation, and premature drive failures.
- Maximum supported SSD power and thermal limits were derived based on thermal testing. The testing used a maximum system configuration with fan redundancy support using a maximum ambient temperature of 35 °C. The test system was based on the system configurations using a maximum number of front and rear drive storage devices: 12 x 3.5" or 24 x 2.5" in the front and 2 x 2.5" in the back. Higher SSD power and thermal limits may be possible with system configurations that support 8 or 16 devices up front, no storage devices configured in back, and lowering the maximum operating ambient temperature.

## 7. Front Control Panel and I/O

This chapter provides information on the front control panel and I/O available on the front and rear of the server system.

### 7.1 Control Panel Features

The front control panel provides push button system controls and LED indicators for several system features.



**Figure 93. Front Control Panel Features**

- Power/Sleep Button w/Integrated LED:** Toggles the system power on and off. This button also functions as a sleep button if enabled by an ACPI compliant operating system. Pressing this button sends a signal to the integrated BMC that either powers on or powers off the system. The integrated LED is a single color (green) and supports different indicator states as defined in the following table.

**Note:** After AC power is connected, several subsystems are initialized and low-level FRU discovery is performed. This process can take up to 90 seconds. When this process is completed, the ID LED turns solid on, indicating that the system is ready to be powered on.

**Table 42. Power / Sleep LED Functional States**

Power Mode	LED	System State	Description
Non-ACPI	Off	Power-off	System power is off and the BIOS has not initialized the chipset PCH.
	On	Power-on	System power is on.
ACPI	Off	S5	Mechanical is off and the operating system has not saved any context to peripheral storage.
	On	S0	System and the operating system are up and running.

- System ID Button w/integrated LED:** Toggles the integrated ID LED button in the front control panel and the integrated ID LED button on the back of the server board on and off. Both LEDs are tied together and show the same state. The onboard system ID LED is on the back edge of the server board, viewable from the back of the system. The system ID LEDs are used to identify the system for maintenance when installed in a rack of similar server systems. Two options available for illuminating the system ID LEDs are:
  - The front panel system ID LED button is pushed, causing the LEDs to illuminate to a solid On state until the button is pushed again.
  - An IPMI Chassis Identify command is remotely entered, causing the LEDs to blink for 15 seconds.
- NMI Button:** When the NMI button is pressed, it puts the system in a halt state and issues a non-maskable interrupt (NMI). This situation can be useful when performing diagnostics for a given issue where a memory download is necessary to help determine the cause of the problem. To prevent an

inadvertent system halt, the actual NMI button is behind the front control panel faceplate where it is only accessible with the use of a small-tipped tool like a pin or paper clip.

- **System Cold Reset Button:** When pressed, this button reboots and re-initializes the system. Unlike the power button, the reset button does not disconnect the power to the system. It just starts the system's Power-On Self-Test (POST) sequence over again.
- **Drive Activity LED** - The drive activity LED on the front panel indicates drive activity from the server board SATA and sSATA storage controllers. The server board also has an I2C header labeled SAS\_MODULE\_MISC to provide access to this LED for add-in SATA or sSATA storage controllers. See Table 30 for SAS/SATA drive activity LED states.
- **System Status LED:** The system status LED is a bi-color (green/amber) indicator that shows the current health of the server system. The system provides two locations for this feature; one is on the front control panel and the other is on the back edge of the server board, viewable from the back of the system. Both LEDs are tied together and show the same state. The system status LED states are driven by the server board platform management subsystem. When the server is powered down (transitions to the DC-Off state or S5), the BMC is still on standby power and retains the sensor and front panel status LED state established before the power-down event. The following table provides a description of each supported LED state.

**Table 43. System Status LED State Definitions**

LED State	System State	BIOS Status Description
Off	No AC Power to system	<ul style="list-style-type: none"> <li>• System power is not present.</li> <li>• System is in EuP Lot6 off mode.</li> </ul>
Solid green	System is operating normally.	<ul style="list-style-type: none"> <li>• System is in S5 soft-Off state.</li> <li>• System is running (in S0 State) and its status is healthy. The system is not exhibiting any errors. Source power is present, BMC has booted, and manageability functionality is up and running.</li> <li>• After a BMC reset, and with the chassis ID solid on, the BMC is booting Linux*. Control has been passed from BMC U-Boot* to BMC Linux. The BMC is in this state for roughly 10–20 seconds.</li> </ul>
Blinking green	System is operating in a degraded state although still functioning, or system is operating in a redundant state but with an impending failure warning.	<ul style="list-style-type: none"> <li>• Redundancy loss such as fan or power-supply (When Power Cold Redundancy is enabled). Applies only if the associated platform subsystem has redundancy capabilities.</li> <li>• Fan warning or failure when the number of fully operational fans is less than the minimum number needed to cool the system.</li> <li>• Non-critical threshold crossed: Temperature (including HSBP temp), voltage, input power to power supply, output current for main power rail from power supply and Processor Thermal Control (Therm Ctrl) sensors.</li> <li>• Power supply predictive failure occurred while redundant power supply configuration was present.</li> <li>• Unable to use all installed memory (more than 1 memory module installed).</li> <li>• Correctable Errors over a threshold and migrating to a spare memory module (memory sparing). This condition indicates that the system no longer has spared memory modules (a redundancy lost condition). Corresponding DIMM LED lit.</li> <li>• In mirrored configuration, when memory mirroring takes place and system loses memory redundancy.</li> <li>• Battery failure.</li> <li>• BMC executing in U-Boot. (Indicated by Chassis ID blinking at 3 Hz while Status blinking at 1 Hz). System in degraded state (no manageability). BMC U-Boot is running but has not transferred control to BMC Linux. Server is in this state 6–8 seconds after BMC reset while it pulls the Linux image into flash.</li> <li>• BMC Watchdog has reset the BMC.</li> <li>• Power Unit sensor offset for configuration error is asserted.</li> <li>• SSD Hot Swap Controller is off-line or degraded.</li> </ul>

LED State	System State	BIOS Status Description
<b>Blinking green and amber alternatively</b>	System is initializing after source power is applied	<ul style="list-style-type: none"> <li>• PFR in the process of updating/authenticating/recovering when source power is connected, system firmware being updated.</li> <li>• System not ready to take power button event/signal.</li> </ul>
<b>Blinking amber</b>	System is operating in a degraded state with an impending failure warning, although still functioning. System is likely to fail.	<ul style="list-style-type: none"> <li>• Critical threshold crossed: Voltage, temperature (including HSBP temp), input power to power supply, output current for main power rail from power supply and PROCHOT (Therm Ctrl) sensors.</li> <li>• VRD Hot asserted.</li> <li>• Minimum number of fans to cool the system not present or failed.</li> <li>• Hard drive fault.</li> <li>• Power Unit Redundancy sensor: Insufficient resources offset (indicates not enough power supplies present).</li> <li>• In non-sparing and non-mirroring mode, if the threshold of correctable errors is crossed within the window.</li> <li>• Invalid firmware image detected during boot or firmware update.</li> </ul>
<b>Solid amber</b>	Critical/non-recoverable: system is halted. Fatal alarm: system has failed or shut down.	<ul style="list-style-type: none"> <li>• Processor CATERR signal asserted.</li> <li>• MSID mismatch detected (CATERR also asserts for this case).</li> <li>• CPU 0 is missing.</li> <li>• Processor Thermal Trip.</li> <li>• No power good: power fault.</li> <li>• Memory module failure when there is only 1 memory module present and hence no good memory present.</li> <li>• Runtime memory uncorrectable error in non-redundant mode.</li> <li>• DIMM Thermal Trip or equivalent.</li> <li>• SSB Thermal Trip or equivalent.</li> <li>• Processor ERR2 signal asserted.</li> <li>• BMC/Video memory test failed. (Chassis ID shows blue/solid-on for this condition.)</li> <li>• Both U-Boot BMC firmware images are bad. (Chassis ID shows blue/solid-on for this condition.)</li> <li>• 240 VA fault.</li> <li>• Fatal Error in processor initialization:                             <ul style="list-style-type: none"> <li>• Processor family not identical</li> <li>• Processor model not identical</li> <li>• Processor core/thread counts not identical</li> <li>• Processor cache size not identical</li> <li>• Unable to synchronize processor frequency</li> <li>• Unable to synchronize QPI link frequency</li> </ul> </li> <li>• BMC fail authentication with non-recoverable condition, system hang at T-1; boot PCH only, system hang; PIT failed, system lockdown.</li> </ul>

## 7.2 Front I/O Features

The system front I/O provides two USB ports as shown in the following figure.

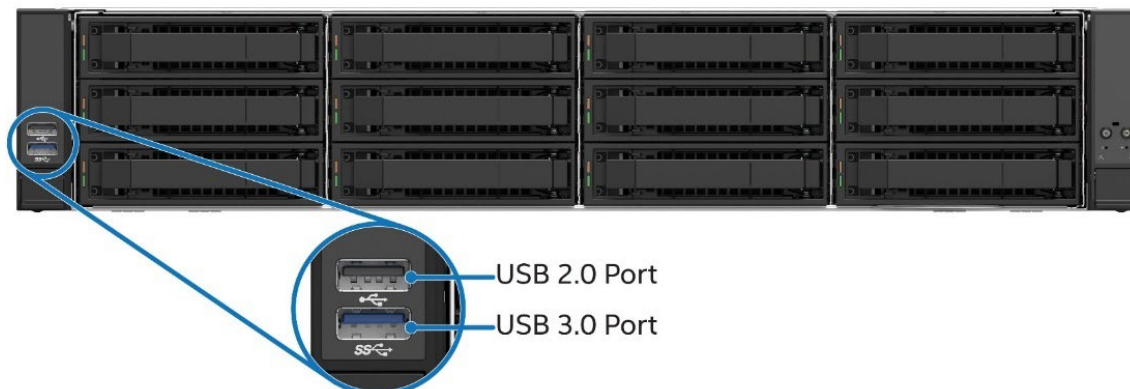
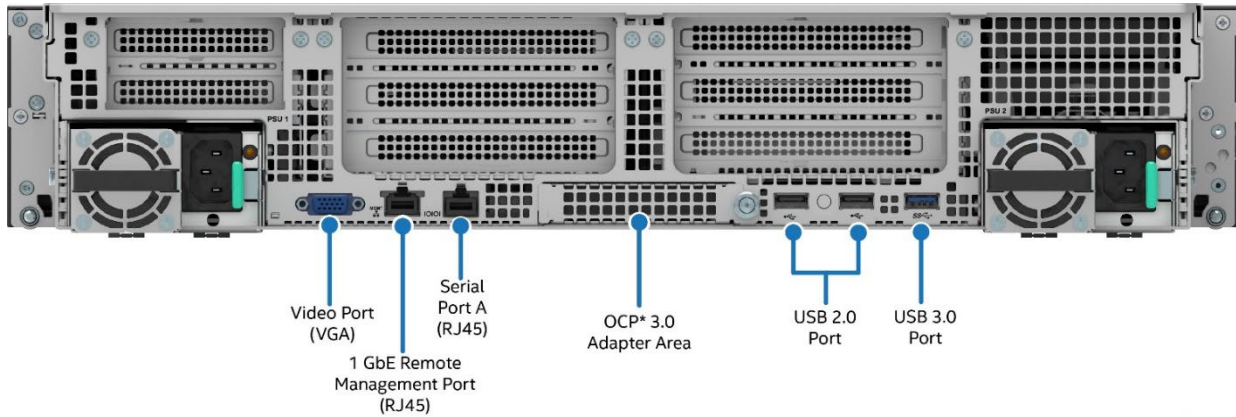


Figure 94. Front I/O Features

CYP20044

### 7.3 Rear I/O Features

The system rear I/O provides serial, video, and USB ports, an OCP adapter bay, and a dedicated management port as shown in the following figure.



Ref #: FCP20032

**Figure 95. Rear I/O Features**

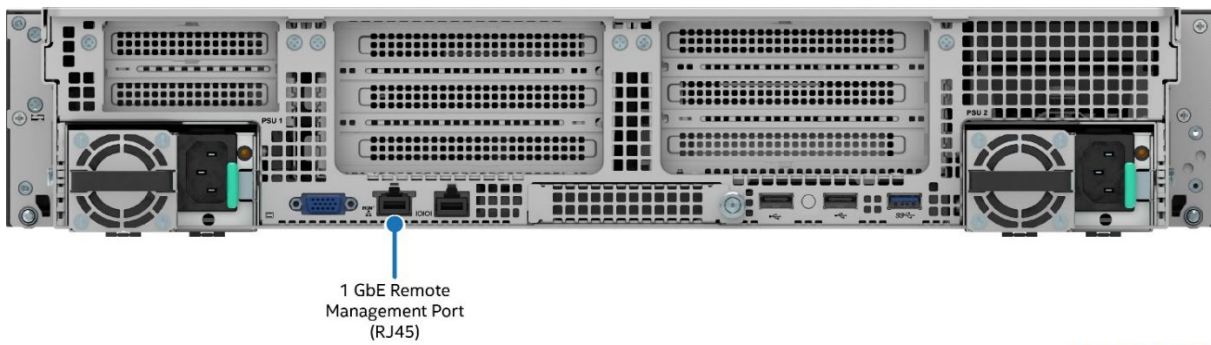
#### 7.3.1 Remote Management Port

The server system includes a dedicated 1 GbE, RJ45 management port used for remote access to embedded system management features.

---

Note: This Ethernet port is dedicated for system management purposes only. It is not intended or designed to support standard LAN data traffic

---

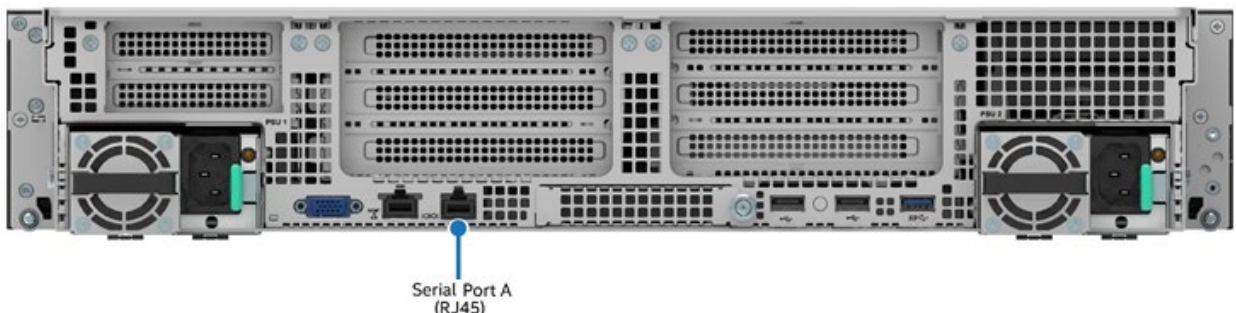


Ref #: FCP20082

**Figure 96. Remote Management Port**

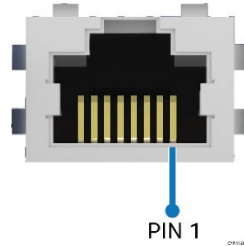
#### 7.3.2 Serial Port A Support

Serial Port A is an external RJ45 type connector on the back edge of the server board as shown in the following figure.



**Figure 97. Serial Port A**

The pin orientation is shown in [Figure 98](#) and the pinout is in [Table 44](#).



**Figure 98. RJ45 Serial Port A Connector Pin Orientation**

**Table 44. RJ45 Serial Port A Connector Pinout**

Pin #	Signal Name	Pin #	Signal Name
1	RTS	5	RI
2	DTR	6	SIN
3	SOUT	7	DCD or DSR
4	GROUND	8	CTS

### 7.3.3 USB Support

The following figure shows the three rear USB ports. The USB 3.0 port is closest to the OCP module connector.



**Figure 99. External USB 2.0 and 3.0 Connector Ports**

### 7.3.4 Video Support

A standard 15-pin video connector is on the back edge of the server board.

#### 7.3.4.1 Video Resolutions

The graphics controller in the Aspeed AST2600\* BMC is a VGA-compliant controller with 2D hardware acceleration and full bus primary support. With 16 MB of memory reserved, the video controller supports the resolutions in the following table.

**Table 45. Supported Video Resolutions**

2D Mode Resolution	2D Video Mode Support (Color Bit)	
	16 bpp	32 bpp
640 x 480	60 Hz	60 Hz
800 x 600	60 Hz	60 Hz
1024 x 768	60 Hz	60 Hz

2D Mode Resolution	2D Video Mode Support (Color Bit)	
	16 bpp	32 bpp
1280 x 800	60 Hz	60 Hz
1280 x 1024	60 Hz	60 Hz
1440 x 900	60 Hz	60 Hz
1680 x 1050	60 Hz	60 Hz
1920 x 1080	60 Hz	60 Hz

#### 7.3.4.2 Server Board Video and Add-In Video Adapter Support

The server board includes two options to attach a monitor to the server system:

- A standard 15-pin video connector on the back of the server system.
- Add-in video cards can be used to either replace or complement the onboard video option of the server board.

The BIOS setup utility includes options to support the desired video operation when an add-in video card is installed.

- When both the Onboard Video and Add-In Video Adapter options are set to Enabled, both video displays can be active. The onboard video is still the primary console and active during BIOS POST. The add-in video adapter is only active under an OS environment with video driver support.
- When Onboard Video is Enabled and Add-In Video Adapter is Disabled, only the onboard video is active.
- When Onboard Video is Disabled and Add-In Video Adapter is Enabled, only the add-in video adapter is active.

Configurations with add-in video cards can get more complicated with a dual processor socket board. Some multi-socket boards have PCIe slots capable of hosting an add-in video card that is attached to the I/Os of processor sockets other than processor socket 0. However, only one processor socket can be designated as a legacy VGA socket as required in POST. To provide for this situation, there is the PCI Configuration option **Legacy VGA Socket**. The rules for this option are:

- The Legacy VGA Socket option is grayed out and unavailable unless an add-in video card is installed in a PCIe slot supported by CPU 1.
- Because the onboard video is hardwired to CPU 0, when Legacy VGA Socket is set to CPU Socket 1, the onboard video is disabled.

#### 7.3.4.3 Dual Monitor Support

The BIOS supports single and dual video when add-in video adapters are installed. No enable/disable option is available in the BIOS setup utility for dual video. It works when both the **Onboard Video** and **Add-In Video Adapter** options are enabled.

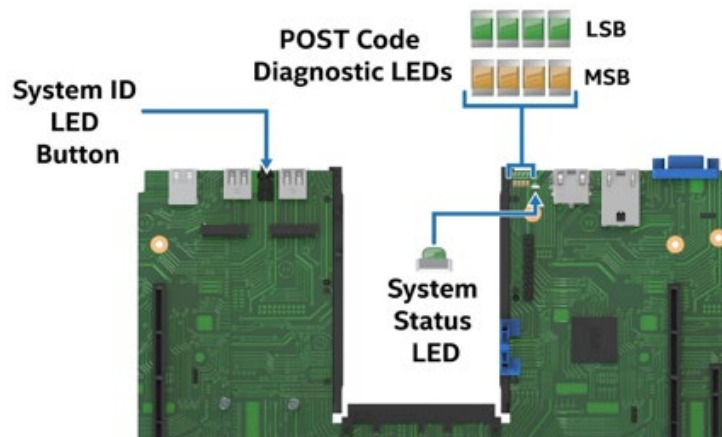
In the single video mode, the onboard video controller or the add-in video adapter is detected during POST.

In dual video mode, the onboard video controller is enabled and is the primary video device while the add-in video adapter is considered as the secondary video device during POST. The add-in video adapter is not active until the operating system environment is loaded.

## 8. Intel® Light-Guided Diagnostics

The Intel® Server System M50FCP2UR includes several LEDs used to provide system status and for diagnostic aids. Some LEDs are only viewable from inside of the server chassis. Others are viewable externally from the back of the system or from the system front Control Panel. See [Section 7.1](#) for a description of LEDs found on the front Control Panel. This chapter will provide a description for all other LEDs.

### 8.1 Post Code Diagnostic LEDs



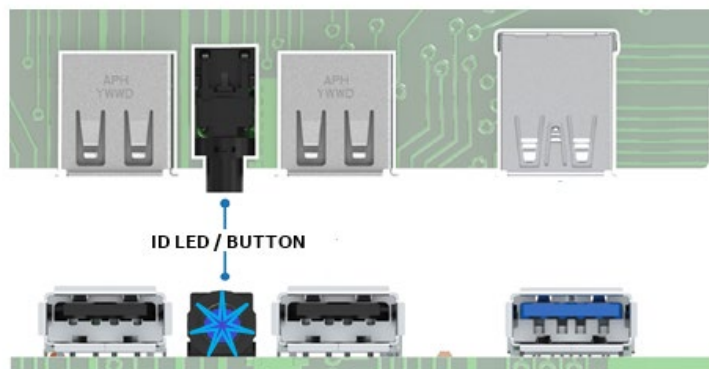
**Figure 100. Exploded View of POST Code Diagnostic, System ID, and System Status LEDs**

As an aid in troubleshooting system hangs that occur during a system POST process, the server board includes a bank of eight (2X4) diagnostic LEDs on the back edge of the server board. These diagnostic LEDs are used to represent hexadecimal POST progress codes or halt error codes for memory initialization and platform configuration routines from the memory reference code (MRC) and system BIOS.

If a system hangs during POST execution, the displayed POST progress code can be used to identify the last POST routine that was run before the error occurred, helping to isolate the possible cause of the hang condition even when video is not available. See the *Intel® Server Board M50FCP2SBSTD Technical Product Specification* for a complete description of how these LEDs are read, and for a list of all supported POST codes.

### 8.2 System ID LED

Blue System ID LEDs can be found integrated within System ID buttons on the back edge of the server board (See [Figure 101](#)) and on the system front Control Panel (See [Figure 93](#)). These LEDs are used to visually identify a specific server system when installed in a rack among many other similar systems.



**Figure 101. System ID LED / Button**



The LED state can be changed using any of three methods:

- Pressing the System ID LED button on the back edge of the server board will produce a solid on state on both the front and rear LEDs and will cause them to stay illuminated until the button is pressed, turning it off.
- Pressing the System ID LED on the system front panel will produce a solid on state on both the front and rear LEDs and will cause them to stay illuminated until the button is pressed, turning it off.
- Issue an IPMI Chassis Identify command. This option causes the System ID LED to blink for up to 2 minutes. The system ID LED on the server board is tied directly to the system ID LED on the system front panel.

## 8.3 System Status LED

The system status LED is a bi-color (green/amber) indicator that shows the current health of the server system. The system provides two locations for this feature; one is on the front control panel and the other is on the back edge of the server board, viewable from the back of the system. Both LEDs are tied together and show the same state. The system status LED states are driven by the server board platform management subsystem. When the server is powered down (transitions to the DC-Off state or S5), the BMC is still on standby power and retains the sensor and front panel status LED state established before the power-down event. See Status LED state definition [Table 43](#) for more information.

### 8.3.1 BMC Boot/Reset Status LED Indicators

During the BMC boot or BMC reset process, the system status LED and system ID LED are used to indicate BMC boot process transitions and states. A BMC boot occurs when the AC power is first applied. (DC power on/off does not reset BMC). BMC reset occurs after a BMC firmware update, on receiving a BMC cold reset command, and following a reset initiated by the BMC watchdog. [Table 46](#) defines the LED states during the BMC boot/reset process.

**Table 46. BMC Boot / Reset Status LED State Definition**

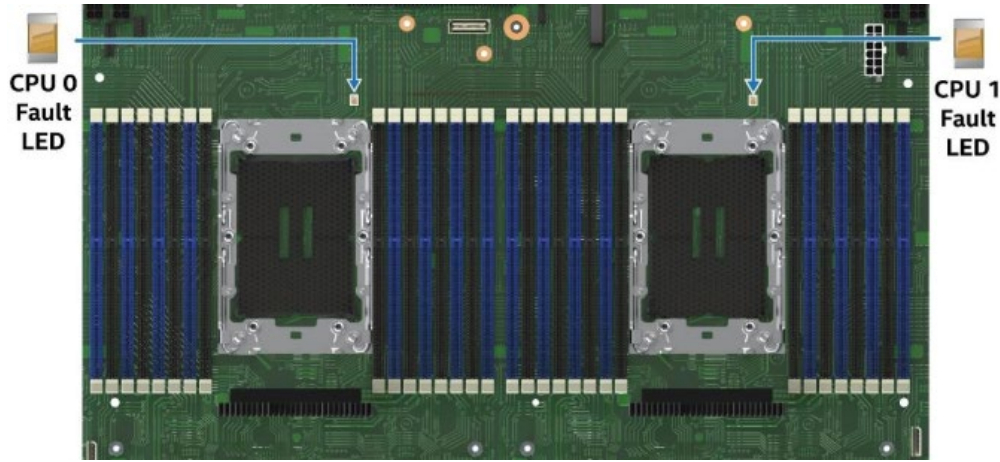
BMC Boot/Reset State	System ID LED	System Status LED	Comment
BMC/video memory test failed	Solid blue	Solid amber	Nonrecoverable condition. Contact an Intel representative for information on replacing this motherboard.
Both universal bootloader (u-Boot) images bad	6 Hz blinking blue	Solid amber	Nonrecoverable condition. Contact an Intel representative for information on replacing this motherboard.
BMC in u-Boot	3 Hz blinking blue	1 Hz blinking green	Blinking green indicates degraded state (no manageability), blinking blue indicates u-Boot is running but has not transferred control to BMC Linux. Server system will be in this state 6–8 seconds after BMC reset while it pulls the Linux image into flash.
BMC booting Linux*	Solid blue	Solid green	After an AC cycle/BMC reset, indicates that the control has been passed from u-Boot to BMC Linux itself. The system is in this state for 10-20 seconds.
End of BMC boot/reset process. Normal system operation	Off	Solid green	Indicates BMC Linux has booted and manageability functionality is up and running. Fault/status LEDs operate as usual.

## 8.4 Processor Fault LEDs

The server board includes a processor fault LED for each processor socket (See [Figure 102](#)). The processor fault LED is lit if an MSID mismatch error is detected, indicating that a processor power rating is incompatible with the board.

**Table 47. Processor Fault LED State Definition**

Component	Managed by	Color	State	Description
Processor Fault LEDs	BMC	Off	Off	Ok (no errors)
		Solid Amber	On	MSID mismatch



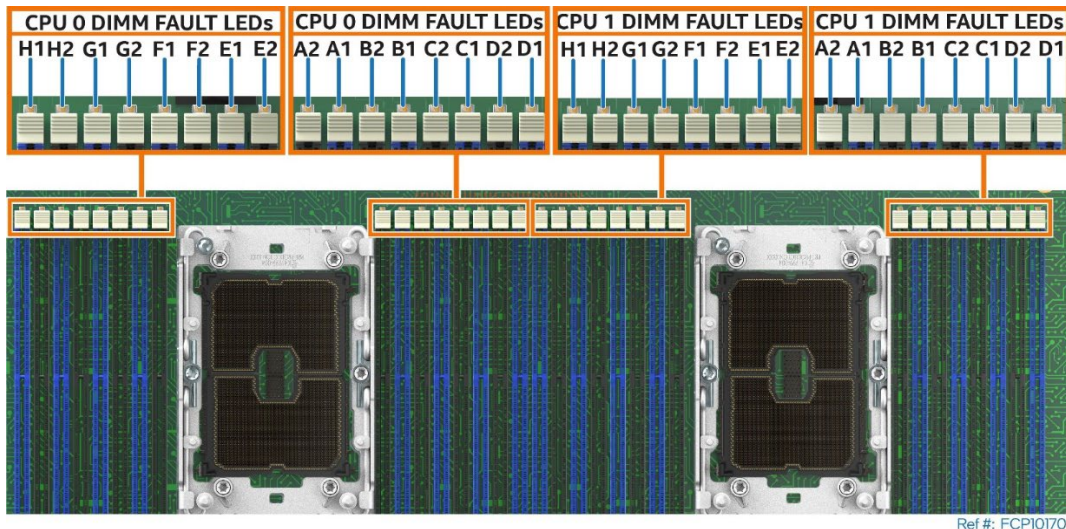
**Figure 102. Processor Fault LEDs**

## 8.5 Memory Fault LEDs

The server board includes a memory fault LED for each memory slot. When the BIOS detects a memory fault condition, it sends an IPMI OEM command (Set Fault Indication) to the BMC to turn on the associated memory slot fault LED. These LEDs are only active when the system is in an On state. The BMC does not activate or change the state of the LEDs unless instructed by the BIOS.

**Table 48. Memory Fault LED State Definition**

Managed	Managed by	Color	State	Description
Memory Fault LED	BMC	Off	Off	Memory working correctly
		Solid amber	On	Memory failure: detected by the BIOS



Ref #: FCP10170

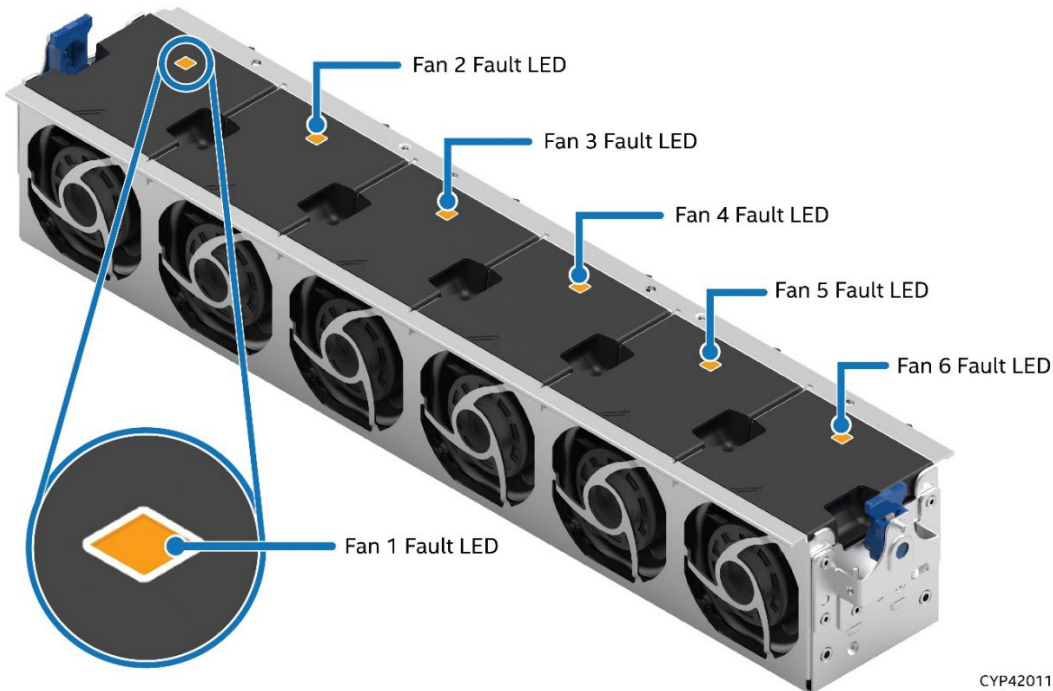
**Figure 103. Memory Fault LED Location**

## 8.6 Fan Fault LEDs

Each system fan within the system fan assembly includes a fault LED positioned on the top side of the fan. The BMC lights a fan fault LED if the associated fan-tach sensor has a lower critical threshold event status asserted. Fan-tach sensors are manual rearm sensors. Once the lower critical threshold is crossed, the LED remains lit until the sensor is rearmed. These sensors are rearmed at system DC power-on and system reset.

**Table 49. Fan Fault LED State Definition**

Component	Managed by	Color	State	Description
Fan Fault LED	BMC	Off	Off	Fan working correctly.
		Solid amber	On	Fan failed.



CYP42011

**Figure 104. Fan Fault LED Location**

### 8.6.1 Power Supply Status LED

See Section 3.7.1.

### 8.6.2 Drive Bay LED

See Section 6.1.1.1 for drive status and drive activity LEDs.

## Appendix A. Getting Help

Available Intel support options with your Intel server system:

1. 24x7 support through Intel's support webpage at <https://www.intel.com/content/www/us/en/support/products/1201/server-products.html>.

Information available at the support site includes:

- Latest BIOS, firmware, drivers, and utilities
- Product documentation, setup, and service guides
- Full product specifications, technical advisories, and errata
- Compatibility documentation for memory, hardware add-in cards, and operating systems
- Server and chassis accessory parts list for ordering upgrades or spare parts
- A searchable knowledge base to search for product information throughout the support site

### Quick Links:

Use the following links for support on Intel Server Boards and Server Systems	<p style="text-align: center;"><b>Download Center</b></p>  <p style="text-align: center;"><a href="http://www.intel.com/support/downloadserversw">http://www.intel.com/support/downloadserversw</a></p>	<p style="text-align: center;"><b>BIOS Support Page</b></p>  <p style="text-align: center;"><a href="http://www.intel.com/support/serverbios">http://www.intel.com/support/serverbios</a></p>	<p style="text-align: center;"><b>Troubleshooting Boot Issue</b></p>  <p style="text-align: center;"><a href="http://www.intel.com/support/tsboot">http://www.intel.com/support/tsboot</a></p>
<p>Use the following links for support on Intel® Data Center Block (DCB) Integrated Systems*</p> <p>* Intel DCB comes pre-populated with processors, memory, storage, and peripherals based on how it was ordered through the Intel Configure to Order tool.</p>	<p style="text-align: center;"><b>Download Center</b></p>  <p style="text-align: center;"><a href="http://www.intel.com/support/downloaddcbsw">http://www.intel.com/support/downloaddcbsw</a></p>	<p style="text-align: center;"><b>Technical Support Documents</b></p>  <p style="text-align: center;"><a href="http://www.intel.com/support/dcb">http://www.intel.com/support/dcb</a></p>	<p style="text-align: center;"><b>Warranty and Support Info</b></p>  <p style="text-align: center;"><a href="http://www.intel.com/support/dcbwarranty">http://www.intel.com/support/dcbwarranty</a></p>

2. If a solution cannot be found at Intel's support site, submit a service request via Intel's online service center at <https://supporttickets.intel.com/servicecenter?lang=en-US>. In addition, you can also view previous support requests. (Login required to access previous support requests).
3. Contact an Intel support representative using one of the support phone numbers available at <https://www.intel.com/content/www/us/en/support/contact-support.html> (charges may apply).

Intel also offers Partner Alliance Program members around-the-clock 24x7 technical phone support on Intel server boards, server chassis, server RAID controller cards, and Intel® Server Management at <https://www.intel.com/content/www/us/en/partner-alliance/overview.html>.

---

**Note:** The 24x7 support number is available after logging in to the Intel® Partner Alliance website.

---

### Warranty Information

To obtain warranty information, visit [http://www.intel.com/p/en\\_US/support/warranty](http://www.intel.com/p/en_US/support/warranty).

## Appendix B. Software License Key Management

### B.1 Ordering Software License Key

There are two options available to order a software license key:

- **CTO/L9:** When ordering a fully integrated system from Intel using its on-line Configure-to-Order (CTO) tool, select the required license key (**AdvSysMgmtKey**, **VROCStanKey** or **VROCPremKey**) as an additional option. The Intel factory will then automatically upload the license key on to the system during the system integration process.
- **Add-on Accessory:** A software license key can be ordered separately from the system as an add-on accessory. This option requires that the license key be manually installed on the system. See the following sections for complete ordering and installation instructions.

### B.2 Order and Register a License Key as an Add-on Accessory (Not via CTO)

1. Place an order for the required software license key with electronic delivery. Intel Product Codes:  
**ADVSYSMGMTKEY** for the Advanced System Management (ASM) Key  
**VROCSTANKEY** for the Intel® Virtual RAID on CPU Standard Software Key  
**VROCPREMKEY** for the Intel® Virtual RAID on CPU Premium Software Key
2. Receive an email with instructions to download the product key.
3. From the email, Click the **Register** link (see [Figure 105](#)) to go to <https://servertools.intel.com/registration>

Purchase Order - PO#

Intel Registration Center [Cons] <noreply-lem-cons@lemcenter.intel.com>  
 To: [Redacted]  
 Retention Policy Mail Cloud - Inbox (60 days) Expires 4/10/2021  
 Tue 2/9/2021 10:29 AM

Click here to download pictures. To help protect your privacy, Outlook prevented automatic download of some pictures in this message.

**Purchase Order**

This email includes all of your purchase information. Keep this email for future reference. Note that you need the serial number to install your new software.

Product : Intel Server Integrated Baseboard Management Controller (BMC) Advanced Features  
 Quantity : 1  
 Product Key 1 : de08176f-db78-4911-ad26-90030d504852 [Register](#)

Product already installed? You can use the new serial number to activate a previously installed product. Please remember to register in order to receive product updates and support menu entry. Click Intel® FlexLM License Manager FAQ for more information about the license manager

In order to register a Floating/concurrent user license you will need to have the host name of the server.

**Click Register**

**Order Summary**

Product : Intel Server Integrated Baseboard Management Controller (BMC) Advanced Features  
 Product Key 1 : de08176f-db78-4911-ad26-90030d504852 [Register](#)  
 Entitlement Activation Info : During activation, please use default fingerprint available in LEM user portal.  
 SKU : ADVSYSMGMTKEY  
 Vendor : Internal  
 Version : 2.42  
 Number of Seats : 1  
 Quantity : 1  
 Support Code : Full Support  
 Support End Date : Never Expire  
 Fulfillment Type :  
 Order Number : 2aae72a9a235497eaede  
 SAP Order Number : NA  
 Comments :

Figure 105. Example Email

4. Login using an existing Intel account or create a new one. An email address is required

5. On the Registration Screen, Click the “Register Product Key” button to register the pre-entered license key number. (see Figure 106)

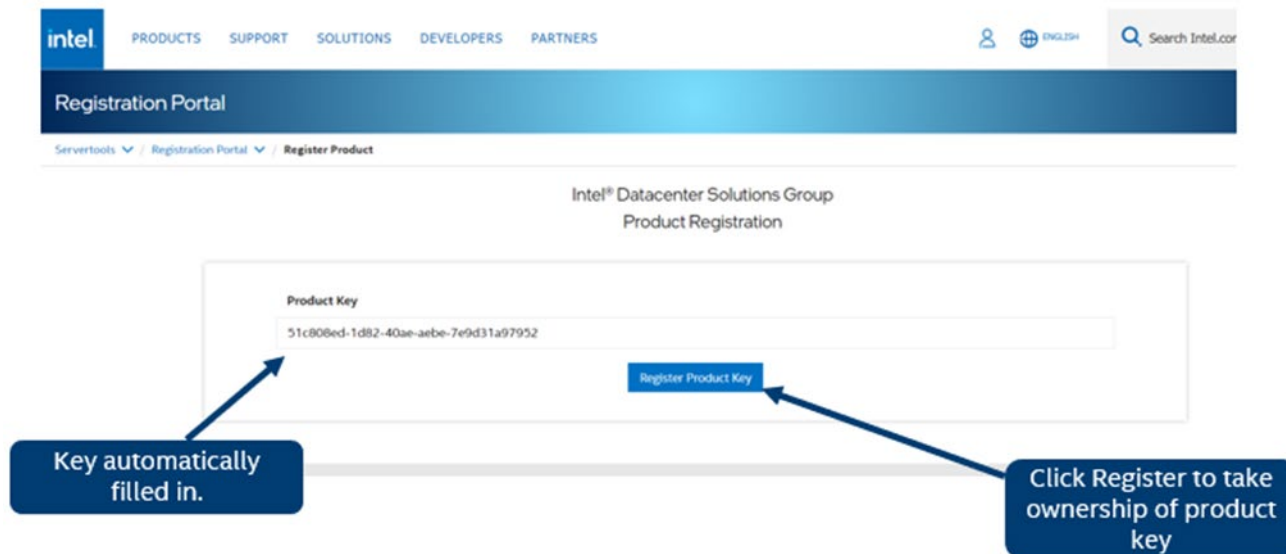


Figure 106. Register Key

6. Enter the number of Advanced System Management (ASM) licenses needed. It must be equal or less that the quantity available displayed on the right corner of the screen. Click on the “Generate License(s)” bottom to download the single license file. (see Figure 107)

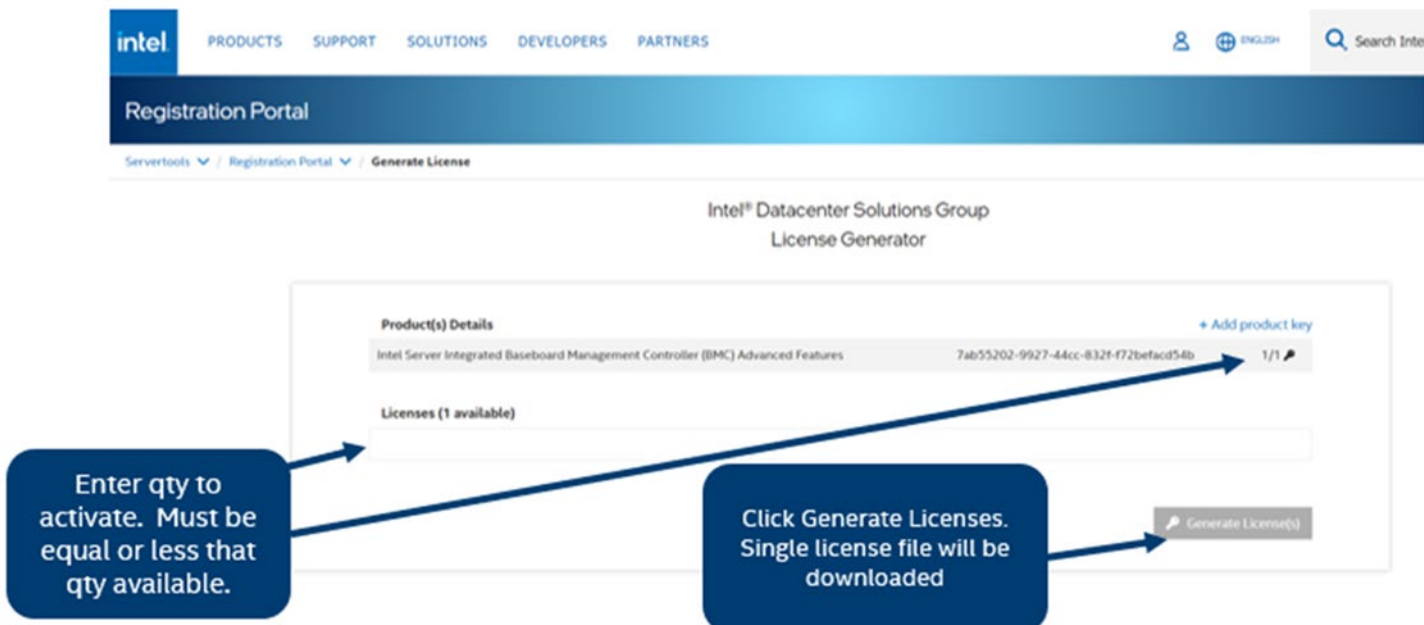


Figure 107. Activate Key for Advanced System Management (ASM) Key

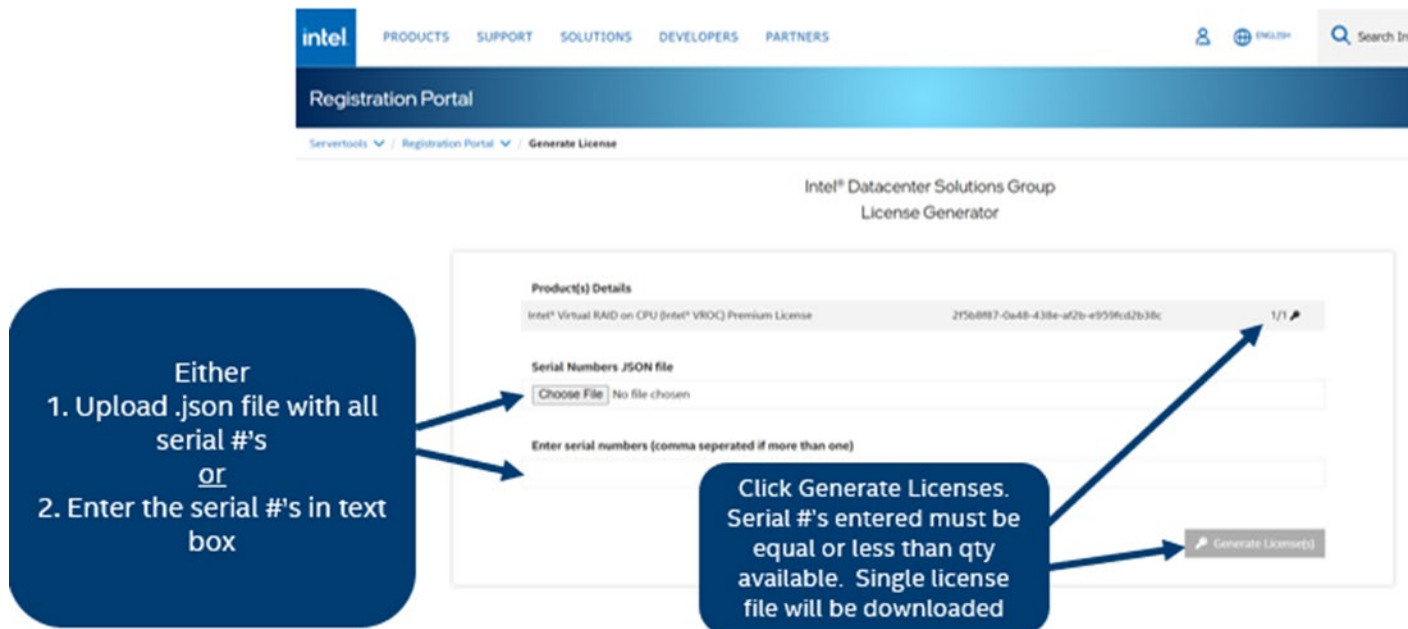
---

**Note:** Only single license file per order is needed to activate multiple systems. If any key or email is lost, Intel can generate new product keys as needed.

---

7. To activate the license for either **VROCSTANKEY** or **VROCPREMKEY**:

- Collect the board serial number. There are several ways to get the board serial number, e.g., barcode label attached to the board, BMC web console, Redfish/IPMI API's and utilities.
- Multiple board serial numbers can be entered in the text box or by uploading a .JSON file with the list. Only a single license file will be downloaded. This single license file will work with all systems that match one of the serial numbers. (see [Figure 108](#))



**Figure 108. Activate Key for Intel® Virtual RAID on CPU Standard/Premium Software Key**

- If using file to upload serial numbers (vs. text box), the following is the JSON format that should be in the file:

```
{ "serialNumbers":
  ["SERIAL1","SERIAL2","SERIAL3"]}
```

Click on “Generate License(s)” bottom to download the single license file. The quantity of the board serial numbers entered must be equal or less than the quantity available displayed on the right corner of the screen.

---

**Note:** Make sure to enter the board serial number NOT the product serial number. Only one of the two methods either the JSON file or the text box is accepted. The license file will work with all systems that match one of the board serial numbers. If any key or email is lost, Intel can generate new product keys as needed.

---

8. Upload the license key file to the BMC.

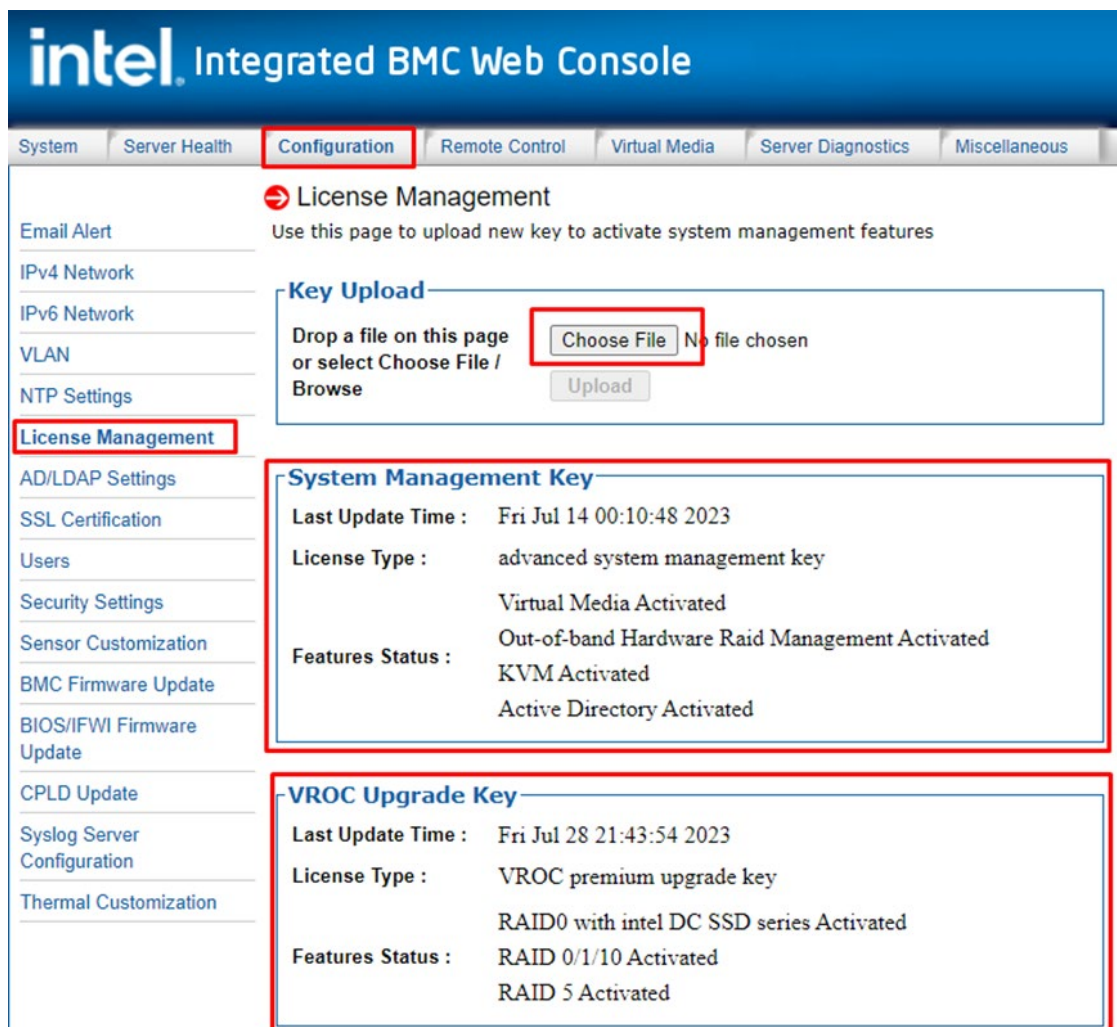
## B.3 Software License Key Installation

Three available options can be used to upload a software license onto a server:

- Integrated BMC Web Console
- Intel® Server Configuration Utility
- Redfish\* Interface

### B.3.1 Installation Using the Integrated BMC Web Console

The following procedure may be used to upload and confirm activation of a software license key. The example below illustrates the process of uploading the Advanced System Management (ASM) license using the Integrated BMC Web Console. The same process can be used to upload VROC software license key.



**Figure 109. Integrated BMC Web Console Advanced System Management Key Page**

1. Login to the Integrated BMC Web Console
2. Navigate to the **Configuration > License Management** page
3. Click the **Choose File** button to select the license key file
4. Select the **.v2c** license key file, then click the **Open** button
5. Click the **Upload** button to upload the ASM License Key or VROC software License key to the BMC
6. The **System Management Key/VROC Upgrade Key** section will show the license type and activated features
7. Navigate back to the **System** Tab. On the **System Information** page, view the **System Summary** information box to confirm the **Advanced Management Key** was successfully **Activated**.





**intel** Integrated BMC Web Console

System | Server Health | Configuration | Remote Control | Virtual Media | Server Diagnostics

➔ Summary

**System Information**

System Components

CPU Information

DIMM Information

NIC Information

NVMe Information

Storage Information

Current Users

**KCS Policy Control Mode is Provisioning. This setting is intended deployment.**

**Summary**

Host Power Status : Host is currently ON

**Advanced Management Key : Activated**

Device (BMC) Available : Yes

BIOS ID : SE5C741.86B.01.01.0004.2303280404

BMC FW Rev : egs-1.53-3-g2a59e1-c2bd0000

BMC Firmware Build Time : Mar 23 2023 10:18:50 UTC

Backup BMC FW Rev : egs-1.09-0-0000

CPLD FW Rev : DNP\_v4p0

Mgmt Engine (ME) FW Rev : 06.00.04.033.0

Baseboard Serial Number : BQDP22400120

Overall System Health : ● ● ●

Figure 110. BMC Web Console System Information Page

### B.3.2 Installation Using the Intel® Server Configuration Utility

The following procedure may be used to upload and confirm activation of the license keys using the syscfg command line utility.

To download the latest utility package, go to <https://downloadcenter.intel.com/> and search for the “Intel Server Configuration Utility”.

Prerequisites:

- Ensure the user has Administrator or Root privileges for the chosen operating system
- Ensure the KCS Policy Control Mode is set to “**Provisioning**”

Procedure:

1. Install the Intel® Server Configuration Utility on to the target server system. See the Intel® Server Configuration Utility User Guide for installation instructions.
2. Navigate to the sub-directory where the Server Configuration Utility was installed
3. From a command prompt run the following command

***syscfg /lic <key file name>***

where “file name” can be just the name of the license file if copied to the same directory as the syscfg command file, or the complete path of where the license key was copied can be entered along with the file name.

The example below illustrates the process of uploading the VROC standard software license key. The same process can be used to upload the Advanced Server Management license key.

```

C:\SYSCFG 16.0.9>syscfg.exe /lic VROCSTANKEY.v2c

Server Configuration Utility Version 16.0.9
Copyright (c) 2023 Intel Corporation

Key Transfer...
Starting key upload:
Key Upload done

VROC license is uploaded successfully

C:\SYSCFG 16.0.9>

```

**Figure 111. Upload VROC Standard License Key Using SYSCFG Utility**

- To confirm activation of the VROC license key, type the following command:  
***syscfg /d lic***

```

C:\SYSCFG 16.0.9>syscfg.exe /d lic

License Status
-----
Type | Status | Time Stamp
-----|-----|-----
ASM key | Activated | 04/16/2023-11:37:04
VROC standard key | Activated | 04/16/2023-11:41:27
VROC premium upgrade key | Not Activated |
-----
C:\SYSCFG 16.0.9>

```

**Figure 112. Confirm Activation of VROC Standard License Key Using SYSCFG Utility**

### B.3.3 Installation Using Redfish\*

The following steps may be used to upload and confirm activation of a software license key using Redfish\*.

Prerequisites:

- If not already present, install the “curl” and “grep” utilities onto the system from which the commands will be run.

Issue the following command to upload a software license key to the BMC

```
curl -k -u username:password
```

```
https://BMC_IP/redfish/v1/UpdateService/SoftwareInventory/LicenseManagement/Actions/Oem/Intel.Oem.Upload -H "Content-Type: multipart/form-data" -F "updateFile=@filepath" -X POST
```

Notes:

- The command line above is a single command line
- “username:password” in the command line above should be replaced with the name of the user and their password

See the example below where:

- username = admin
- password = password
- BMC\_IP = 192.168.0.102
- filepath = VROCPREMKEY.v2c

```
C:\SYS CFG 16.0.9>curl -k -u admin:password
https://192.168.0.102/redfish/v1/UpdateService/SoftwareInventory/LicenseManagement/Actions/Oem/Intel.Oem.Upload -H
"Content-Type: multipart/form-data" -F "file=@VROCPREMKEY.v2c" -X POST
{
  "@odata.id": "/redfish/v1/TaskService/Tasks/2",
  "@odata.type": "#Task.v1_4_3.Task",
  "Id": "2",
  "TaskState": "Running",
  "TaskStatus": "OK"
}
C:\SYS CFG 16.0.9>
```

**Figure 113. Redfish Command to Upload the VROC Premium Software License Key**

Issue the following command to verify the activation status of the license keys.

```
curl -k -u username:password
https://BMC_IP/redfish/v1/UpdateService/SoftwareInventory/LicenseManagement#Oem/LicenseInventory/Licenses -H "content-type: application/json" -X GET | grep -A1 LicenseStatus
```

```
C:\SYS CFG 16.0.9>curl -k -u admin:password
https://192.168.0.102/redfish/v1/UpdateService/SoftwareInventory/LicenseManagement#Oem/LicenseInventory/Licenses -H
"content-type: application/json" -X GET | grep -A1 LicenseStatus
% Total    % Received % Xferd Average Speed   Time    Time     Time  Current
   Dload  Upload   Total   Spent    Left   Speed
100 3306    100 3306    0     0  6480    0  --:--:-- --:--:-- --:--:--  6507
"LicenseStatus": "ACTIVATED",
"LicenseType": "advanced system management key",
--
"LicenseStatus": "ACTIVATED",
"LicenseType": "VROC premium upgrade key",
```

**Figure 114. Redfish Command to verify the activation status of the VROC Software License Key**

## Appendix C. Integration and Usage Tips

This appendix provides a list of useful information that is unique to the Intel® Server System M50FCP2UR and should be kept in mind while configuring your server system.

- When adding or removing components or peripherals from the server board, power cords must be disconnected from the server. With power applied to the server, standby voltages are still present even though the server board is powered off.
- The server boards support the 4<sup>th</sup> & 5<sup>th</sup> Gen Intel® Xeon® Scalable processor family with a Thermal Design Power (TDP) of up to and including 350 Watts. Previous generations of the Intel® Xeon® processor and Intel® Xeon® Scalable processor families are not supported.
- Processors must be installed in order. CPU 0 must be populated for the server board to operate.
- Riser Card Slots #2 and #3 on the server board can only be used in dual processor configurations.
- The riser card slots are specifically designed to support riser cards only. Attempting to install a PCIe add-in card directly into a riser card slot on the server board may damage the server board, the add-in card, or both.
- For the best performance, the number of DDR5 DIMMs installed should be balanced across both processor sockets and memory channels.
- On the back edge of the server board, there are eight diagnostic LEDs that display a sequence of POST codes during the boot process. If the server board hangs during POST, the LEDs display the last POST event run before the hang.
- The system status LED is set to a steady amber color for all fatal errors that are detected during processor initialization. A steady amber system status LED indicates that an unrecoverable system failure condition has occurred.
- RAID partitions created using either Intel® VMD cannot span across the two embedded SATA controllers. Only drives attached to a common SATA controller can be included in a RAID partition.
- Make sure that the latest system software is loaded on the server. The software includes system BIOS, BMC firmware, Intel® ME firmware, and FRUSDR. The latest system software can be downloaded from <http://downloadcenter.intel.com>.

## Appendix D. System Configuration Table for Thermal Compatibility

This appendix provides tables that list system configuration compatibility data based on various supported system operating thermal limits. Section C.1 and C.2 identify supported system configurations for systems operating in a “normal” operating mode. In a normal operating mode, all system fans are present, online, and operational.

Section C.3 identifies supported system configurations for systems operating in a “fan fail” mode. In a fan fail mode, one fan rotor within the system is in a failed state. The system is still operational. However, fan redundancy is lost. System throttling may occur, impacting system performance. The system cannot keep system thermals below upper critical limits if >1 fan rotors fail.

Some system configurations can operate at elevated ASHRAE Class A3 and A4 environmental limits for specific amounts of time per year without impacting long term reliability.

- ASHRAE Class A3 – Includes operation up to 40C for up to 900 hours per year
- ASHRAE Class A4 – Includes operation up to 45C for up to 90 hours per year

---

Note: A system operating at elevated ambient temperatures may initiate thermal throttling which will impact system performance. See Note #2 in the following list.

---

**The following configuration support notes may not apply to ALL system configurations. Applicable notes for specific system configurations will be identified by number for in the following tables.**

### Thermal Configuration Support Notes:

#### Environment

1. The 27°C configuration alone is limited to elevations of 900m or less. Altitudes higher than 900m need to be de-rated to ASHRAE Class 2 levels.
2. For ASHRAE Class 3 and Class 4 support, the following power supply margin is required to meet thermal specifications:
  - For dual power supply configurations, the power budget must fit within a single power supply rated load and be installed in a dual configuration.
  - For single power supply configurations, the power budget must be sized with 30% margin to single power supply rated load.

#### Processor/DIMM

3. Follow TMSDG rev1p6 to evaluate CPU support matrix.
4. CPU support matrix is based on CPU base configuration of TMSDG. If the end user change to other CPU configuration mode, it is possible to see performance impact.

5. Processor and Memory throttling may occur with ambient temperatures  $\leq 10\text{C}$  over 35C. System performance may be impacted, but the system will remain operational.
6. Heavy processor and memory throttling will occur with ambient temperatures  $>10\text{C}$  over 35C. System performance will be impacted, but the system will remain operational

### Key System Components

7. A power supply inlet temperature sensor that exceeds 61C OTP will influence system power and impact system performance.
8. Use of the designated PCIe slot is limited to add-in cards that have airflow requirements of 100 LFM or less. See add-in card specs for airflow requirements.
9. 2U system configurations have support for OCP V3 add-in cards with a max 25W power consumption and must turn on fan#4 (50% duty) to cool OCP V3 under AUX mode. Only PSU 1+1 supports OCP V3 AUX mode.
10. Rear fixed mount SSDs are limited to SATA type (<4W).
11. M.2 drives are limited to OS and boost only and may see performance impact under heavy work load.
12. Used Intel D5-P4326, 15.36TB NVMe SSD for thermal testing.
13. If the end user installs any SSD in the system w/o NVME sensor temp reading in EWS, the end user should manually turn fan profile to "Performance" mode in BIOS.
14. If the end user installs any GPGPU in the system w/o temperature sensor reading in EWS, the end user should manually turn fan profile to "Performance" mode in BIOS.
15. See [Chapter 4](#) for thermal limitations.

### System

16. R2224 and R2312 don't support double wide PCIe add-in cards due to airflow limitations
17. When selected placeholder x16 double width item, Processor heatsinks change from 2U to 1U. Air duct changes to FCPGPGPUKIT
18. When selected placeholder x 16 double width item, Riser changes to double width (first card changes Riser 1 to FCP2URISER1DW, SECOND CARD CHANGES Riser2 to FCP2URISER2DW).
19. NVIDIA\* A16/A30/A40/A100-40G/A100-80G/H100 only support in R2216 and R2208 at A1.
20. NVIDIA A2 is only supported in R2200 configurations. R2224 support to 15C, R2216 support to 25C and R2208 support to 27C.
21. For Intel Flex 170 (150W), R2224 support to 25C, R2216 and R2208 support to A2 (Need to set FAN to performance mode in BIOS).
22. For Intel Flex140 (75W), R2224 NVMe w/ 2U HS support to 27C, other config. can support to A2 (Need to set FAN to performance mode in BIOS).
23. For Intel PVC, the supporting is reviewed by spec. R2224 support to 27C, R2216 support to A1 and R2208 support to A2.
24. If the end user installs Intel ATS-M1 GPGPU, the end user should remove Mylar on air duct to enlarge airflow to ATS-M1 card.
25. R2312 with 2U HS supports 250W CPU TDP at A1 condition. The gating item is CPU. CPU fails 4.7C for 270W CPU.
26. R2312 with 1U HS supports 185W CPU TDP at A1 condition. The gating item is CPU. CPU fails 5.1C for 195W CPU.
27. R2224/R2216/R2208 with 2U HS support 350W CPU TDP at A2 condition.
28. R2224/R2216 with 1U HS support 205W CPU TDP at A2 condition.
29. R2208 with 1U HS support 250W CPU TDP at A2 condition.

- 30. M.2 drives are limited to OS and boost only and may see performance impact under heavy work load
- 31. System cooling capability testing was carried out in environmental lab controlled conditions according to the ASHRAE standard.
- 32. Performance depends on data center environmental temperature and relative humidity levels controls provided by end user.
- 33. It is the system integrator's responsibility to consider both thermal configuration matrix and power budget tool documents to arrange end use configuration.

**Fan failure**

- 34. To support system fan redundancy, the system must be configured with two power supplies to maintain sufficient cooling. Concurrent system and power supply fan failures are not supported.
- 35. Fan failure support optimization frequency. DIMM/CPU may appear throttling but system not shutdown.
- 36. In fan fail mode, Intel OCP Modules are only supported in the specified base system model configured.

**Single processor**

- 37. Intel does not consider a single processor configuration as standard for this system product family. No fan fail testing was performed on single processor configurations.

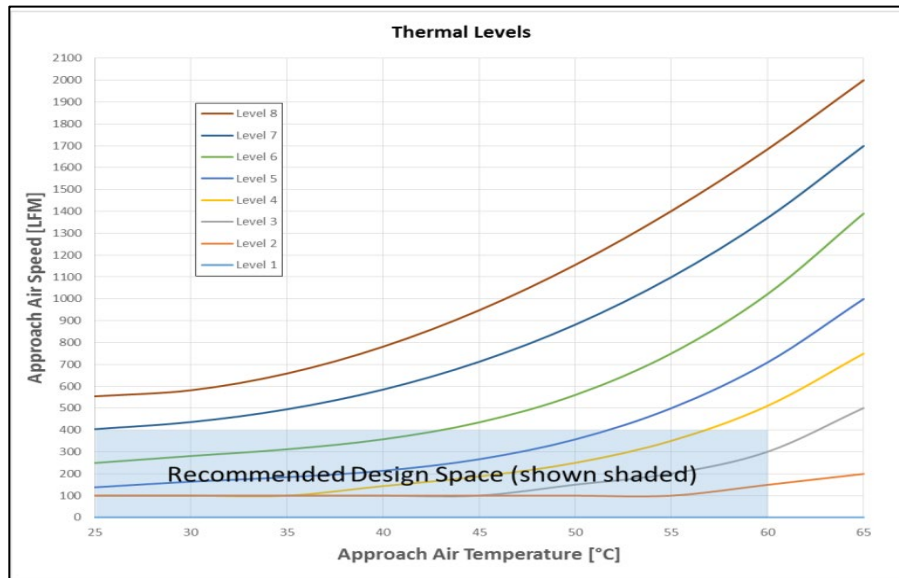


Figure 115. PCIe SIG Add-in cards thermal level

## C.1 Normal Operating Mode with Dual Processors Installed

**Table 50. Thermal testing results interpretation for air-cooled systems**

● ●	System is capable of full performance
● ○	System is capable of full performance but may throttle in fan failure mode
○ ○	System may experience some performance loss at high workloads
● -	System capable of full performance but system cooling is not redundant
○ -	System may experience some performance loss and cooling is not redundant
-	Configuration is not supported

**Table 51. Thermal Configuration Matrix with Dual 4<sup>th</sup> Gen Processors Installed – Normal Operating Mode (Table 1 of 4) (M50FCP2UR208 x24 Drive with 2U Heat Sink)**

Intel® Server M50FCPR2UR208X24, 2U Heatsink, Air-cooled								
Max Ambient Temperature	15°C	20°C	25°C	27°C	32°C	35°C	40°C	45°C
<b>CPU SKU</b>	<b>CPU Support (TDP 350W)</b>							
Intel® Xeon® Platinum 8490H, 350W, 60C	● ●	● -	● -	● -	● -	● -	○ -	-
Intel® Xeon® Platinum 8480+, 350W, 56C	● ●	● -	● -	● -	● -	● -	○ -	-
Intel® Xeon® Platinum 8470, 350W, 52C	● ●	● -	● -	● -	● -	● -	○ -	-
Intel® Xeon® Platinum 8468, 350W, 48C	● ●	● -	● -	● -	● -	● -	○ -	-
Intel® Xeon® Platinum 8458P, 350W, 44C	● ●	● -	● -	● -	● -	● -	○ -	-
Intel® Xeon® Platinum 8468V, 330W, 48C	● ●	● -	● -	● -	● -	● -	○ -	-
Intel® Xeon® Platinum 8468H, 330W, 48C	● ●	● -	● -	● -	● -	● -	○ -	-
Intel® Xeon® Platinum 8460H, 330W, 40C	● ●	● -	● -	● -	● -	● -	○ -	-
Intel® Xeon® Platinum 8471N, 300W, 52C	● ●	● ●	● -	● -	● -	● -	● -	-
Intel® Xeon® Platinum 8470N, 300W, 52C	● ●	● ●	● -	● -	● -	● -	● -	-
Intel® Xeon® Platinum 8461V, 300W, 48C	● ●	● ●	● -	● -	● -	● -	● -	-
Intel® Xeon® Platinum 8460Y+, 300W, 40C	● ●	● ●	● -	● -	● -	● -	● -	-
Intel® Xeon® Platinum 8452Y, 300W, 36C	● ●	● ●	● -	● -	● -	● -	● -	-



Intel® Server System M50FCP2UR Technical Product Specification

Intel® Xeon® Gold 6454S, 270W, 32C	●●	●●	●●	●-	●-	●-	●-	○-
Intel® Xeon® Platinum 8454H, 270W, 32C	●●	●●	●●	●-	●-	●-	●-	○-
Intel® Xeon® Gold 6430, 270W, 32C	●●	●●	●●	●-	●-	●-	●-	○-
Intel® Xeon® Platinum 8444H, 270W, 16C	●●	●●	●●	●-	●-	●-	●-	○-
Intel® Xeon® Gold 6414U, 250W, 32C	●●	●●	●●	●●	●-	●-	●-	●-
Intel® Xeon® Platinum 8450H, 250W, 28C	●●	●●	●●	●●	●-	●-	●-	●-
Intel® Xeon® Platinum 8462Y+, 300W, 32C	●●	●●	●-	●-	●-	●-	○-	-
Intel® Xeon® Gold 6444Y, 270W, 16C	●●	●●	●●	●-	●-	●-	○-	-
Intel® Xeon® Gold 6448H, 250W, 32C	●●	●●	●●	●●	●-	●-	●-	●-
Intel® Xeon® Gold 6448Y, 225W, 32C	●●	●●	●●	●●	●-	●-	●-	●-
Intel® Xeon® Gold 6442Y, 225W, 24C	●●	●●	●●	●●	●-	●-	●-	●-
Intel® Xeon® Gold 6438M, 205W, 32C	●●	●●	●●	●●	●●	●-	●-	●-
Intel® Xeon® Gold 6438N, 205W, 32C	●●	●●	●●	●●	●●	●-	●-	●-
Intel® Xeon® Gold 6438Y+, 205W, 32C	●●	●●	●●	●●	●●	●-	●-	●-
Intel® Xeon® Gold 5420+, 205W, 28C	●●	●●	●●	●●	●●	●-	●-	●-
Intel® Xeon® Gold 6434, 195W, 8C	●●	●●	●●	●●	●○	●○	○-	-
Intel® Xeon® Gold 6434H, 195W, 8C	●●	●●	●●	●●	●○	●○	○-	-
Intel® Xeon® Gold 6428N, 185W, 32C	●●	●●	●●	●●	●●	●●	●-	●-
Intel® Xeon® Gold 6421N, 185W, 32C	●●	●●	●●	●●	●●	●●	●-	●-
Intel® Xeon® Gold 5418Y, 185W, 24C	●●	●●	●●	●●	●●	●●	●-	●-
Intel® Xeon® Gold 6418H, 185W, 24C	●●	●●	●●	●●	●●	●●	●-	●-
Intel® Xeon® Gold 5412U, 185W, 24C	●●	●●	●●	●●	●●	●●	●-	●-
Intel® Xeon® Gold 6426Y, 185W, 16C	●●	●●	●●	●●	●●	●●	●-	●-
Intel® Xeon® Gold 5418N, 165W, 24C	●●	●●	●●	●●	●●	●●	●-	●-
Intel® Xeon® Gold 5411N, 165W, 24C	●●	●●	●●	●●	●●	●●	●-	●-
Intel® Xeon® Silver 4416+, 165W, 20C	●●	●●	●●	●●	●●	●●	●-	●-

Intel® Server System M50FCP2UR Technical Product Specification

Intel® Xeon® Gold 6416H, 165W, 18C	●●	●●	●●	●●	●●	●●	●-	●-
Intel® Xeon® Gold 5416S, 150W, 16C	●●	●●	●●	●●	●●	●●	●●	●-
Intel® Xeon® Silver 4410Y, 150W, 12C	●●	●●	●●	●●	●●	●●	●●	●-
Intel® Xeon® Gold 5415+, 150W, 8C	●●	●●	●●	●●	●●	●●	●●	●-
Intel® Xeon® Bronze 3408U, 125W, 8C	●●	●●	●●	●●	●●	●●	●●	●-
Intel® Xeon® Silver 4410T, 150W, 10C	●●	●●	●●	●●	●●	●●	●●	●-
<b>Memory Type</b>	<b>Memory Support</b>							
DDR5, DRx8, 1x, 1DPC	●●	●●	●●	●●	●●	●○	●○	●○
DDR5, DRx4, 1x, 1DPC	●○	●○	●○	●○	●○	●○	●○	●-
DDR5, QRx4, 1x, 1DPC	●○	●○	●○	●○	●○	●○	●-	-
DDR5, DRx8, 1x, 2DPC	●●	●●	●●	●●	●●	●●	●●	●●
DDR5, DRx4, 1x, 2DPC	●●	●●	●●	●●	●●	●●	●○	●○
DDR5, QRx4, 1x, 2DPC	●●	●●	●●	●●	●○	●○	●○	●-
DDR5, DRx8, 2x, 1DPC	●●	●●	●●	●●	●●	●●	●●	●○
DDR5, DRx4, 2x, 1DPC	●●	●●	●○	●○	●○	●○	●○	●○
DDR5, QRx4, 2x, 1DPC	●○	●○	●○	●○	●○	●○	●○	●-
DDR5, DRx8, 2x, 2DPC	●●	●●	●●	●●	●●	●●	●●	●●
DDR5, DRx4, 2x, 2DPC	●●	●●	●●	●●	●●	●●	●●	●○
DDR5, QRx4, 2x, 2DPC	●●	●●	●●	●●	●●	●○	●○	●○
<b>PCI Card Cooling</b>	<b>Supported Thermal Level</b>							
Riser 1 slot 1	LEVEL7 / LEVEL6	LEVEL7 / LEVEL6	LEVEL7 / LEVEL6	LEVEL7 / LEVEL6	LEVEL7 / LEVEL6	LEVEL6 / LEVEL5	LEVEL6 / LEVEL5	LEVEL5 / LEVEL4
Riser 1 slot 2	LEVEL7 / LEVEL7	LEVEL7 / LEVEL6	LEVEL7 / LEVEL6	LEVEL7 / LEVEL6	LEVEL7 / LEVEL6	LEVEL7 / LEVEL6	LEVEL6 / LEVEL5	LEVEL6 / LEVEL5
Riser 1 slot 3	LEVEL7 / LEVEL6	LEVEL7 / LEVEL6	LEVEL7 / LEVEL6	LEVEL7 / LEVEL6	LEVEL7 / LEVEL6	LEVEL6 / LEVEL5	LEVEL6 / LEVEL5	LEVEL5 / LEVEL4
Riser 2 slot 1	LEVEL7 / LEVEL6	LEVEL7 / LEVEL6	LEVEL7 / LEVEL6	LEVEL7 / LEVEL6	LEVEL6 / LEVEL5	LEVEL6 / LEVEL5	LEVEL6 / LEVEL3	LEVEL5 / LEVEL3

Intel® Server System M50FCP2UR Technical Product Specification

Riser 2 slot 2	LEVEL7 / LEVEL7	LEVEL7 / LEVEL7	LEVEL7 / LEVEL7	LEVEL7 / LEVEL7	LEVEL6 / LEVEL6	LEVEL6 / LEVEL6	LEVEL5 / LEVEL5	LEVEL4 / LEVEL4
Riser 2 slot 3	LEVEL7 / LEVEL7	LEVEL7 / LEVEL7	LEVEL7 / LEVEL7	LEVEL7 / LEVEL7	LEVEL6 / LEVEL6	LEVEL6 / LEVEL6	LEVEL5 / LEVEL5	LEVEL4 / LEVEL4
Riser 3 slot 1	LEVEL7 / LEVEL7	LEVEL7 / LEVEL7	LEVEL7 / LEVEL7	LEVEL7 / LEVEL7	LEVEL6 / LEVEL6	LEVEL6 / LEVEL6	LEVEL6 / LEVEL6	LEVEL5 / LEVEL5
Riser 3 slot 2	LEVEL7 / LEVEL7	LEVEL7 / LEVEL7	LEVEL7 / LEVEL7	LEVEL7 / LEVEL7	LEVEL6 / LEVEL6	LEVEL6 / LEVEL6	LEVEL6 / LEVEL5	LEVEL5 / LEVEL4
<b>3.5" SAS/SATA SSD</b>	<b>3.5" SAS/SATA SSD Support</b>							
Rated to 60C	-	-	-	-	-	-	-	-
<b>2.5" PCIe NVMe SSD</b>	<b>2.5" PCIe NVMe SSD Support</b>							
NVMe TDP = 25W, Rated to 70C	●●	●●	●●	●●	●●	●●	●○	●-
<b>GPGPU card type</b>	<b>GPGPU card Support</b>							
Nvidia DW GPGPU - A16/A30/A40/A100-40G/A100-80G/H100	-	-	-	-	-	-	-	-
Intel® FPGA PAC D5005 - DW - 225W	-	-	-	-	-	-	-	-
PonteVecchio - DW - 300W	-	-	-	-	-	-	-	-
Intel ATS M1 - FH, 3/4 Length, Single Slot - 150W	-	-	-	-	-	-	-	-
Nvidia Tesla A2 - LP- 60W	●-	-	-	-	-	-	-	-
Intel ATS M3 - LP- 75W	●-	-	-	-	-	-	-	-
<b>Rear SSD above PSUs</b>	<b>Rear SSD Support</b>							
SATA SSD, Rated to 70C	●●	●●	●●	●●	●●	●●	●○	●-
<b>M.2 SSD</b>	<b>M.2 NVMe SSD Support</b>							
Micron 7400/7450 series (rated to 70C, TDP = 8W)	●●	●●	●●	●-	-	-	-	-
Other NVMe/SATA SSD in APlist (rated to 70C)	●●	●●	●●	●●	●●	●●	●○	●-
<b>PSU</b>	<b>PSU Support (Fan normal : 350W / Fan fail : 205W)</b>							

Intel® Server System M50FCP2UR Technical Product Specification

2100W	●●	●●	●●	●●	●●	●○	●-	-
1600W	●●	●●	●●	●●	●●	●○	●-	-
1300W	●●	●●	●●	●●	●●	●○	●-	-
<b>OCP V3</b>	<b>OCP V3 Support</b>							
OCP 25W w/ class-2 QSFP	●●	●●	●●	●●	●●	●●	●○	-
<b>Battery Backup</b>	<b>Battery Backup Support</b>							
BBU inlet (rated to 45C)	●●	●●	●●	●○	●○	●○	○-	-

**Table 52. Thermal Configuration Matrix with Dual 4<sup>th</sup> Gen Processors Installed – Normal Operating Mode (Table 2 of 4) (M50FCP2UR208 x24 Drive with 1U Heat Sink)**

Intel® Server M50FCPR2UR208X24, 1U Heatsink, Air-cooled								
Max Ambient Temperature	15°C	20°C	25°C	27°C	32°C	35°C	40°C	45°C
<b>CPU SKU</b>	<b>CPU Support (TDP 205W)</b>							
Intel® Xeon® Gold 6438M, 205W, 32C	●●	●●	●●	●●	●●	●○	●-	○-
Intel® Xeon® Gold 6438N, 205W, 32C	●●	●●	●●	●●	●●	●○	●-	○-
Intel® Xeon® Gold 6438Y+, 205W, 32C	●●	●●	●●	●○	●○	○○	-	-
Intel® Xeon® Gold 5420+, 205W, 28C	●●	●●	●●	●●	●●	●○	●-	○-
Intel® Xeon® Gold 6434, 195W, 8C	●●	●○	○○	○○	-	-	-	-
Intel® Xeon® Gold 6434H, 195W, 8C	●●	●○	○○	○○	-	-	-	-
Intel® Xeon® Gold 6428N, 185W, 32C	●●	●●	●●	●●	●●	●●	●-	●-
Intel® Xeon® Gold 6421N, 185W, 32C	●●	●●	●●	●●	●●	●●	●-	●-
Intel® Xeon® Gold 5418Y, 185W, 24C	●●	●●	●●	●●	●●	●○	●-	○-
Intel® Xeon® Gold 6418H, 185W, 24C	●●	●●	●●	●●	●●	●○	●-	○-
Intel® Xeon® Gold 5412U, 185W, 24C	●●	●●	●●	●●	●●	●○	●-	○-

Intel® Server System M50FCP2UR Technical Product Specification

Intel® Xeon® Gold 6426Y, 185W, 16C	●●	●●	●●	●●	●●	●○	●-	○-
Intel® Xeon® Gold 5418N, 165W, 24C	●●	●●	●●	●●	●●	●●	●●	●-
Intel® Xeon® Gold 5411N, 165W, 24C	●●	●●	●●	●●	●●	●●	●●	●-
Intel® Xeon® Silver 4416+, 165W, 20C	●●	●●	●●	●●	●●	●●	●●	●-
Intel® Xeon® Gold 6416H, 165W, 18C	●●	●●	●●	●●	●●	●●	●●	●-
Intel® Xeon® Gold 5416S, 150W, 16C	●●	●●	●●	●●	●●	●●	●●	●-
Intel® Xeon® Silver 4410Y, 150W, 12C	●●	●●	●●	●●	●●	●●	●○	●-
Intel® Xeon® Gold 5415+, 150W, 8C	●●	●●	●●	●●	●●	●●	●○	●-
Intel® Xeon® Bronze 3408U, 125W, 8C	●●	●●	●●	●●	●●	●●	●●	●○
Intel® Xeon® Silver 4410T, 150W, 10C	●●	●●	●●	●●	●●	●●	●●	●-
<b>Memory Type</b>	<b>Memory Support</b>							
DDR5, DRx8, 1x, 1DPC	●●	●●	●●	●●	●●	●●	●●	●●
DDR5, DRx4, 1x, 1DPC	●●	●●	●●	●●	●●	●○	●○	●○
DDR5, QRx4, 1x, 1DPC	●●	●●	●●	●●	●○	●○	●○	●○
DDR5, DRx8, 1x, 2DPC	●●	●●	●●	●●	●●	●●	●●	●●
DDR5, DRx4, 1x, 2DPC	●●	●●	●●	●●	●●	●●	●●	●●
DDR5, QRx4, 1x, 2DPC	●●	●●	●●	●●	●●	●●	●●	●○
DDR5, DRx8, 2x, 1DPC	●●	●●	●●	●●	●●	●●	●●	●●
DDR5, DRx4, 2x, 1DPC	●●	●●	●●	●●	●●	●●	●●	●○
DDR5, QRx4, 2x, 1DPC	●●	●●	●●	●●	●●	●○	●○	●○
DDR5, DRx8, 2x, 2DPC	●●	●●	●●	●●	●●	●●	●●	●●
DDR5, DRx4, 2x, 2DPC	●●	●●	●●	●●	●●	●●	●●	●●
DDR5, QRx4, 2x, 2DPC	●●	●●	●●	●●	●●	●●	●●	●●
<b>PCI Card Cooling</b>	<b>Supported Thermal Level</b>							
Riser 1 slot 1	LEVEL7 / LEVEL7	LEVEL7 / LEVEL7	LEVEL7 / LEVEL7	LEVEL7 / LEVEL7	LEVEL7 / LEVEL6	LEVEL7 / LEVEL6	LEVEL6 / LEVEL5	LEVEL6 / LEVEL4

Intel® Server System M50FCP2UR Technical Product Specification

Riser 1 slot 2	LEVEL7 / LEVEL7	LEVEL7 / LEVEL7	LEVEL7 / LEVEL7	LEVEL7 / LEVEL7	LEVEL6 / LEVEL7	LEVEL6 / LEVEL6	LEVEL6 / LEVEL6	LEVEL5 / LEVEL5
Riser 1 slot 3	LEVEL7 / LEVEL7	LEVEL7 / LEVEL7	LEVEL7 / LEVEL7	LEVEL7 / LEVEL7	LEVEL6 / LEVEL6	LEVEL6 / LEVEL6	LEVEL6 / LEVEL6	LEVEL5 / LEVEL5
Riser 2 slot 1	LEVEL7 / LEVEL4	LEVEL7 / LEVEL4	LEVEL7 / LEVEL4	LEVEL7 / LEVEL4	LEVEL6 / LEVEL4	LEVEL6 / LEVEL2	LEVEL6 / LEVEL2	LEVEL5 / LEVEL2
Riser 2 slot 2	LEVEL7 / LEVEL7	LEVEL7 / LEVEL7	LEVEL7 / LEVEL7	LEVEL7 / LEVEL7	LEVEL6 / LEVEL6	LEVEL6 / LEVEL6	LEVEL5 / LEVEL6	LEVEL4 / LEVEL5
Riser 2 slot 3	LEVEL7 / LEVEL7	LEVEL7 / LEVEL7	LEVEL7 / LEVEL7	LEVEL7 / LEVEL7	LEVEL6 / LEVEL6	LEVEL6 / LEVEL6	LEVEL6 / LEVEL6	LEVEL5 / LEVEL5
Riser 3 slot 1	LEVEL7 / LEVEL7	LEVEL7 / LEVEL7	LEVEL7 / LEVEL7	LEVEL7 / LEVEL7	LEVEL7 / LEVEL6	LEVEL6 / LEVEL6	LEVEL6 / LEVEL5	LEVEL5 / LEVEL4
Riser 3 slot 2	LEVEL7 / LEVEL7	LEVEL7 / LEVEL7	LEVEL7 / LEVEL7	LEVEL7 / LEVEL7	LEVEL7 / LEVEL6	LEVEL6 / LEVEL6	LEVEL6 / LEVEL5	LEVEL5 / LEVEL4
<b>3.5" SAS/SATA SSD</b>	<b>3.5" SAS/SATA SSD Support</b>							
Rated to 60C	-	-	-	-	-	-	-	-
<b>2.5" PCIe NVMe SSD</b>	<b>2.5" PCIe NVMe SSD Support</b>							
NVMe TDP = 25W, Rated to 70C	●●	●●	●●	●●	●●	●●	●○	●-
<b>GPGPU card type</b>	<b>GPGPU card Support</b>							
Nvidia DW GPGPU - A16/A30/A40/A100-40G/A100-80G/H100	-	-	-	-	-	-	-	-
Intel® FPGA PAC D5005 - DW - 225W	-	-	-	-	-	-	-	-
PonteVecchio - DW - 300W	-	-	-	-	-	-	-	-
Intel ATS M1 - FH, 3/4 Length, Single Slot - 150W	●-	●-	●-	-	-	-	-	-
Nvidia Tesla A2 - LP- 60W	●-	-	-	-	-	-	-	-
Intel ATS M3 - LP- 75W	●-	●-	●-	-	-	-	-	-
<b>Rear SSD above PSUs</b>	<b>Rear SSD Support</b>							
SATA SSD, Rated to 70C	●●	●●	●●	●●	●●	●●	●○	●-
<b>M.2 SSD</b>	<b>M.2 NVMe SSD Support</b>							

Intel® Server System M50FCP2UR Technical Product Specification

Micron 7400/7450 series (rated to 70C, TDP = 8W)	●●	●●	●●	●-	-	-	-	-
Other NVMe/SATA SSD in APlist (rated to 70C)	●●	●●	●●	●●	●●	●●	●○	●-
<b>PSU</b>	<b>PSU Support (Fan normal: 205W / Fan fail : 185W)</b>							
2100W	●●	●●	●●	●●	●●	●●	●-	●-
1600W	●●	●●	●●	●●	●●	●●	●-	●-
1300W	●●	●●	●●	●●	●●	●●	●-	●-
<b>OCP V3</b>	<b>OCP V3 Support</b>							
OCP 25W w/ class-2 QSFP	●●	●●	●●	●●	●●	●●	●○	-
<b>Battery Backup</b>	<b>Battery Backup Support</b>							
BBU inlet (rated to 45C)	●●	●●	●●	●○	●○	●○	○-	-

**Table 53. Thermal Configuration Matrix with Dual 5<sup>th</sup> Gen Processors Installed – Normal Operating Mode (Table 3 of 4) (M50FCP2UR208 x24 Drive with 2U Heat Sink)**

Intel® Server M50FCPR2UR208X24, 2U Heatsink, Air-cooled								
Max Ambient Temperature	15°C	20°C	25°C	27°C	32°C	35°C	40°C	45°C
<b>CPU SKU</b>	<b>CPU Support (TDP 350W)</b>							
Intel® Xeon® Platinum 8592+, 350W, 64C	●●	●-	●-	●-	●-	●-	●-	-
Intel® Xeon® Platinum 8580, 350W, 60C	●●	●-	●-	●-	●-	●-	●-	-
Intel® Xeon® Platinum 8570, 350W, 56C	●●	●-	●-	●-	●-	●-	●-	-
Intel® Xeon® Platinum 8558P, 350W, 48C	●●	●-	●-	●-	●-	●-	○-	-
Intel® Xeon® Platinum 8568Y+, 350W, 48C	●●	●-	●-	●-	●-	●-	●-	-
Intel® Xeon® Platinum 8592V, 330W, 64C	●●	●-	●-	●-	●-	●-	○-	-
Intel® Xeon® Platinum 8558, 330W, 48C	●●	●-	●-	●-	●-	●-	○-	-
Intel® Xeon® Platinum 8571N, 300W, 52C	●●	●●	●-	●-	●-	●-	●-	-
Intel® Xeon® Platinum 8558U, 300W, 48C	●●	●●	●-	●-	●-	●-	●-	-

Intel® Server System M50FCP2UR Technical Product Specification

Intel® Xeon® Platinum 8581V, 270W, 60C	●●	●●	●●	●-	●-	●-	●-	-
Intel® Xeon® Gold 6554S, 270W, 36C	●●	●●	●●	●-	●-	●-	●-	-
Intel® Xeon® Gold 6530, 270W, 32C	●●	●●	●●	●-	●-	●-	●-	-
Intel® Xeon® Platinum 8562Y+, 300W, 32C	●●	●●	●-	●-	●-	●-	○-	-
Intel® Xeon® Gold 6544Y, 270W, 16C	●●	●●	●●	●-	●-	●-	○-	-
Intel® Xeon® Gold 6548Y+, 250W, 32C	●●	●●	●●	●●	●-	●-	●-	●-
Intel® Xeon® Gold 6548N, 250W, 32C	●●	●●	●●	●●	●-	●-	●-	●-
Intel® Xeon® Gold 6542Y, 250W, 24C	●●	●●	●●	●●	●-	●-	●-	●-
Intel® Xeon® Gold 6538Y+, 225W, 32C	●●	●●	●●	●●	●-	●-	●-	●-
Intel® Xeon® Gold 6538N, 205W, 32C	●●	●●	●●	●●	●●	●-	●-	●-
Intel® Xeon® Gold 5520+, 205W, 28C	●●	●●	●●	●●	●●	●-	●-	●-
Intel® Xeon® Gold 6526Y, 195W, 16C	●●	●●	●●	●●	●●	●●	●-	●-
Intel® Xeon® Gold 6534, 195W, 8C	●●	●●	●●	●●	●○	●○	○-	-
Intel® Xeon® Gold 5512U, 185W, 28C	●●	●●	●●	●●	●●	●●	●-	●-
Intel® Xeon® Gold 5515+, 165W, 8C	●●	●●	●●	●●	●●	●●	●-	●-
Intel® Xeon® Gold 4514Y, 150W, 16C	●●	●●	●●	●●	●●	●●	●●	●-
Intel® Xeon® Silver 4516Y+, 185W, 24C	●●	●●	●●	●●	●●	●●	●-	●-
Intel® Xeon® Silver 4510, 150W, 12C	●●	●●	●●	●●	●●	●●	●●	●-
<b>Memory Type</b>	<b>Memory Support</b>							
DDR5, DRx8, 1x, 1DPC	●●	●●	●●	●●	●●	●○	●○	●○
DDR5, DRx4, 1x, 1DPC	●○	●○	●○	●○	●○	●○	●○	●-
DDR5, QRx4, 1x, 1DPC	●○	●○	●○	●○	●○	●○	●-	-
DDR5, DRx8, 1x, 2DPC	●●	●●	●●	●●	●●	●●	●●	●●
DDR5, DRx4, 1x, 2DPC	●●	●●	●●	●●	●●	●●	●○	●○
DDR5, QRx4, 1x, 2DPC	●●	●●	●●	●●	●○	●○	●○	●-
DDR5, DRx8, 2x, 1DPC	●●	●●	●●	●●	●●	●●	●●	●○



Intel® Server System M50FCP2UR Technical Product Specification

DDR5, DRx4, 2x, 1DPC	●●	●●	●○	●○	●○	●○	●○	●○
DDR5, QRx4, 2x, 1DPC	●○	●○	●○	●○	●○	●○	●○	●-
DDR5, DRx8, 2x, 2DPC	●●	●●	●●	●●	●●	●●	●●	●●
DDR5, DRx4, 2x, 2DPC	●●	●●	●●	●●	●●	●●	●●	●○
DDR5, QRx4, 2x, 2DPC	●●	●●	●●	●●	●●	●○	●○	●○
<b>PCI Card Cooling</b>	<b>Supported Thermal Level</b>							
Riser 1 slot 1	LEVEL7 / LEVEL6	LEVEL7 / LEVEL6	LEVEL7 / LEVEL6	LEVEL7 / LEVEL6	LEVEL7 / LEVEL6	LEVEL6 / LEVEL5	LEVEL6 / LEVEL5	LEVEL5 / LEVEL4
Riser 1 slot 2	LEVEL7 / LEVEL7	LEVEL7 / LEVEL6	LEVEL7 / LEVEL6	LEVEL7 / LEVEL6	LEVEL7 / LEVEL6	LEVEL7 / LEVEL6	LEVEL6 / LEVEL5	LEVEL6 / LEVEL5
Riser 1 slot 3	LEVEL7 / LEVEL6	LEVEL7 / LEVEL6	LEVEL7 / LEVEL6	LEVEL7 / LEVEL6	LEVEL7 / LEVEL6	LEVEL6 / LEVEL5	LEVEL6 / LEVEL5	LEVEL5 / LEVEL4
Riser 2 slot 1	LEVEL7 / LEVEL6	LEVEL7 / LEVEL6	LEVEL7 / LEVEL6	LEVEL7 / LEVEL6	LEVEL6 / LEVEL5	LEVEL6 / LEVEL5	LEVEL6 / LEVEL3	LEVEL5 / LEVEL3
Riser 2 slot 2	LEVEL7 / LEVEL7	LEVEL7 / LEVEL7	LEVEL7 / LEVEL7	LEVEL7 / LEVEL7	LEVEL6 / LEVEL6	LEVEL6 / LEVEL6	LEVEL5 / LEVEL5	LEVEL4 / LEVEL4
Riser 2 slot 3	LEVEL7 / LEVEL7	LEVEL7 / LEVEL7	LEVEL7 / LEVEL7	LEVEL7 / LEVEL7	LEVEL6 / LEVEL6	LEVEL6 / LEVEL6	LEVEL5 / LEVEL5	LEVEL4 / LEVEL4
Riser 3 slot 1	LEVEL7 / LEVEL7	LEVEL7 / LEVEL7	LEVEL7 / LEVEL7	LEVEL7 / LEVEL7	LEVEL6 / LEVEL6	LEVEL6 / LEVEL6	LEVEL6 / LEVEL6	LEVEL5 / LEVEL5
Riser 3 slot 2	LEVEL7 / LEVEL7	LEVEL7 / LEVEL7	LEVEL7 / LEVEL7	LEVEL7 / LEVEL7	LEVEL6 / LEVEL6	LEVEL6 / LEVEL6	LEVEL6 / LEVEL5	LEVEL5 / LEVEL4
<b>3.5" SAS/SATA SSD</b>	<b>3.5" SAS/SATA SSD Support</b>							
Rated to 60C	-	-	-	-	-	-	-	-
<b>2.5" PCIe NVMe SSD</b>	<b>2.5" PCIe NVMe SSD Support</b>							
NVMe TDP = 25W, Rated to 70C	●●	●●	●●	●●	●●	●●	●○	●-
<b>GPGPU card type</b>	<b>GPGPU card Support</b>							
Nvidia DW GPGPU - A16/A30/A40/A100-40G/A100-80G/H100	-	-	-	-	-	-	-	-
Intel® FPGA PAC D5005 - DW - 225W	-	-	-	-	-	-	-	-
PonteVecchio - DW - 300W	-	-	-	-	-	-	-	-

Intel® Server System M50FCP2UR Technical Product Specification

Intel ATS M1 - FH, 3/4 Length, Single Slot - 150W	-	-	-	-	-	-	-	-
Nvidia Tesla A2 - LP- 60W	●-	-	-	-	-	-	-	-
Intel ATS M3 - LP- 75W	●-	-	-	-	-	-	-	-
<b>Rear SSD above PSUs</b>	<b>Rear SSD Support</b>							
SATA SSD, Rated to 70C	●●	●●	●●	●●	●●	●●	●○	●-
<b>M.2 SSD</b>	<b>M.2 NVMe SSD Support</b>							
Micron 7400/7450 series (rated to 70C, TDP = 8W)	●●	●●	●●	●-	-	-	-	-
Other NVMe/SATA SSD in APlist (rated to 70C)	●●	●●	●●	●●	●●	●●	●○	●-
<b>PSU</b>	<b>PSU Support (Fan normal: 350W / Fan fail : 205W)</b>							
2100W	●●	●●	●●	●●	●●	●○	●-	-
1600W	●●	●●	●●	●●	●●	●○	●-	-
1300W	●●	●●	●●	●●	●●	●○	●-	-
<b>OCP V3</b>	<b>OCP V3 Support</b>							
OCP 25W w/ class-2 QSFP	●●	●●	●●	●●	●●	●●	●○	-
<b>Battery Backup</b>	<b>Battery Backup Support</b>							
BBU inlet (rated to 45C)	●●	●●	●●	●○	●○	●○	○-	-

**Table 54. Thermal Configuration Matrix with Dual 5<sup>th</sup> Gen Processors Installed – Normal Operating Mode (Table 4 of 4) (M50FCP2UR208 x24 Drive with 1U Heat Sink)**

Intel® Server M50FCPR2UR208X24, 1U Heatsink, Air-cooled								
Max Ambient Temperature	15°C	20°C	25°C	27°C	32°C	35°C	40°C	45°C
<b>CPU SKU</b>	<b>CPU Support (TDP 205W)</b>							
Intel® Xeon® Gold 6538N, 205W, 32C	●●	●●	●●	●●	●●	●○	●-	○-
Intel® Xeon® Gold 5520+, 205W, 28C	●●	●●	●●	●●	●●	●○	●-	○-

Intel® Server System M50FCP2UR Technical Product Specification

Intel® Xeon® Gold 6526Y, 195W, 16C	●●	●●	●●	●●	●●	●○	●-	○-
Intel® Xeon® Gold 6534, 195W, 8C	●●	●○	○○	○○	-	-	-	-
Intel® Xeon® Gold 5512U, 185W, 28C	●●	●●	●●	●●	●●	●●	●-	●-
Intel® Xeon® Silver 4516Y+, 185W, 24C	●●	●●	●●	●●	●●	●○	●-	○-
Intel® Xeon® Gold 5515+, 165W, 8C	●●	●●	●●	●●	●●	●○	●○	○-
Intel® Xeon® Gold 4514Y, 150W, 16C	●●	●●	●●	●●	●●	●●	●○	●-
Intel® Xeon® Silver 4510, 150W, 12C	●●	●●	●●	●●	●●	●●	●○	●-
<b>Memory Type</b>	<b>Memory Support</b>							
DDR5, DRx8, 1x, 1DPC	●●	●●	●●	●●	●●	●●	●●	●●
DDR5, DRx4, 1x, 1DPC	●●	●●	●●	●●	●●	●○	●○	●○
DDR5, QRx4, 1x, 1DPC	●●	●●	●●	●●	●○	●○	●○	●○
DDR5, DRx8, 1x, 2DPC	●●	●●	●●	●●	●●	●●	●●	●●
DDR5, DRx4, 1x, 2DPC	●●	●●	●●	●●	●●	●●	●●	●●
DDR5, QRx4, 1x, 2DPC	●●	●●	●●	●●	●●	●●	●●	●○
DDR5, DRx8, 2x, 1DPC	●●	●●	●●	●●	●●	●●	●●	●●
DDR5, DRx4, 2x, 1DPC	●●	●●	●●	●●	●●	●●	●●	●○
DDR5, QRx4, 2x, 1DPC	●●	●●	●●	●●	●●	●○	●○	●○
DDR5, DRx8, 2x, 2DPC	●●	●●	●●	●●	●●	●●	●●	●●
DDR5, DRx4, 2x, 2DPC	●●	●●	●●	●●	●●	●●	●●	●●
DDR5, QRx4, 2x, 2DPC	●●	●●	●●	●●	●●	●●	●●	●●
<b>PCI Card Cooling</b>	<b>Supported Thermal Level</b>							
Riser 1 slot 1	LEVEL7 / LEVEL7	LEVEL7 / LEVEL7	LEVEL7 / LEVEL7	LEVEL7 / LEVEL7	LEVEL7 / LEVEL6	LEVEL7 / LEVEL6	LEVEL6 / LEVEL5	LEVEL6 / LEVEL4
Riser 1 slot 2	LEVEL7 / LEVEL7	LEVEL7 / LEVEL7	LEVEL7 / LEVEL7	LEVEL7 / LEVEL7	LEVEL6 / LEVEL7	LEVEL6 / LEVEL6	LEVEL6 / LEVEL6	LEVEL5 / LEVEL5
Riser 1 slot 3	LEVEL7 / LEVEL7	LEVEL7 / LEVEL7	LEVEL7 / LEVEL7	LEVEL7 / LEVEL7	LEVEL6 / LEVEL6	LEVEL6 / LEVEL6	LEVEL6 / LEVEL6	LEVEL5 / LEVEL5

Intel® Server System M50FCP2UR Technical Product Specification

Riser 2 slot 1	LEVEL7 / LEVEL4	LEVEL7 / LEVEL4	LEVEL7 / LEVEL4	LEVEL7 / LEVEL4	LEVEL6 / LEVEL4	LEVEL6 / LEVEL2	LEVEL6 / LEVEL2	LEVEL5 / LEVEL2
Riser 2 slot 2	LEVEL7 / LEVEL7	LEVEL7 / LEVEL7	LEVEL7 / LEVEL7	LEVEL7 / LEVEL7	LEVEL6 / LEVEL6	LEVEL6 / LEVEL6	LEVEL5 / LEVEL6	LEVEL4 / LEVEL5
Riser 2 slot 3	LEVEL7 / LEVEL7	LEVEL7 / LEVEL7	LEVEL7 / LEVEL7	LEVEL7 / LEVEL7	LEVEL6 / LEVEL6	LEVEL6 / LEVEL6	LEVEL6 / LEVEL6	LEVEL5 / LEVEL5
Riser 3 slot 1	LEVEL7 / LEVEL7	LEVEL7 / LEVEL7	LEVEL7 / LEVEL7	LEVEL7 / LEVEL7	LEVEL7 / LEVEL6	LEVEL6 / LEVEL6	LEVEL6 / LEVEL5	LEVEL5 / LEVEL4
Riser 3 slot 2	LEVEL7 / LEVEL7	LEVEL7 / LEVEL7	LEVEL7 / LEVEL7	LEVEL7 / LEVEL7	LEVEL7 / LEVEL6	LEVEL6 / LEVEL6	LEVEL6 / LEVEL5	LEVEL5 / LEVEL4
<b>3.5" SAS/SATA SSD</b>	<b>3.5" SAS/SATA SSD Support</b>							
Rated to 60C	-	-	-	-	-	-	-	-
<b>2.5" PCIe NVMe SSD</b>	<b>2.5" PCIe NVMe SSD Support</b>							
NVMe TDP = 25W, Rated to 70C	●●	●●	●●	●●	●●	●●	●○	●-
<b>GPGPU card type</b>	<b>GPGPU card Support</b>							
Nvidia DW GPGPU - A16/A30/A40/A100-40G/A100-80G/H100	-	-	-	-	-	-	-	-
Intel® FPGA PAC D5005 - DW - 225W	-	-	-	-	-	-	-	-
PonteVecchio - DW - 300W	-	-	-	-	-	-	-	-
Intel ATS M1 - FH, 3/4 Length, Single Slot - 150W	●-	●-	●-	-	-	-	-	-
Nvidia Tesla A2 - LP- 60W	●-	-	-	-	-	-	-	-
Intel ATS M3 - LP- 75W	●-	●-	●-	-	-	-	-	-
<b>Rear SSD above PSUs</b>	<b>Rear SSD Support</b>							
SATA SSD, Rated to 70C	●●	●●	●●	●●	●●	●●	●○	●-
<b>M.2 SSD</b>	<b>M.2 NVMe SSD Support</b>							
Micron 7400/7450 series (rated to 70C, TDP = 8W)	●●	●●	●●	●-	-	-	-	-
Other NVMe/SATA SSD in APlist (rated to 70C)	●●	●●	●●	●●	●●	●●	●○	●-

Intel® Server System M50FCP2UR Technical Product Specification

PSU	PSU Support (Fan normal: 205W / Fan fail : 185W)							
2100W	●●	●●	●●	●●	●●	●●	●-	●-
1600W	●●	●●	●●	●●	●●	●●	●-	●-
1300W	●●	●●	●●	●●	●●	●●	●-	●-
OCP V3	OCP V3 Support							
OCP 25W w/ class-2 QSFP	●●	●●	●●	●●	●●	●●	●○	-
Battery Backup	Battery Backup Support							
BBU inlet (rated to 45C)	●●	●●	●●	●○	●○	●○	○-	-

**Table 55. Thermal Configuration Matrix with Dual 4<sup>th</sup> Gen Processors Installed – Normal Operating Mode (Table 1 of 4) (M50FCP2UR x16 Drive with 2U Heat Sink)**

Intel® Server M50FCPR2UR208x16, 2U Heatsink, Air-cooled								
Max Ambient Temperature	15°C	20°C	25°C	27°C	32°C	35°C	40°C	45°C
CPU SKU	CPU Support (TDP 350W)							
Intel® Xeon® Platinum 8490H, 350W, 60C	●●	●●	●●	●●	●-	●-	●-	-
Intel® Xeon® Platinum 8480+, 350W, 56C	●●	●●	●●	●●	●-	●-	●-	-
Intel® Xeon® Platinum 8470, 350W, 52C	●●	●●	●●	●●	●-	●-	●-	-
Intel® Xeon® Platinum 8468, 350W, 48C	●●	●●	●●	●●	●-	●-	●-	-
Intel® Xeon® Platinum 8458P, 350W, 44C	●●	●●	●●	●●	●-	●-	●-	-
Intel® Xeon® Platinum 8468V, 330W, 48C	●●	●●	●●	●●	●-	●-	●-	●-
Intel® Xeon® Platinum 8468H, 330W, 48C	●●	●●	●●	●●	●-	●-	●-	●-

Intel® Server System M50FCP2UR Technical Product Specification

Intel® Xeon® Platinum 8460H, 330W, 40C	●●	●●	●●	●●	●-	●-	●-	●-
Intel® Xeon® Platinum 8471N, 300W, 52C	●●	●●	●●	●●	●●	●-	●-	●-
Intel® Xeon® Platinum 8470N, 300W, 52C	●●	●●	●●	●●	●●	●-	●-	●-
Intel® Xeon® Platinum 8461V, 300W, 48C	●●	●●	●●	●●	●●	●-	●-	●-
Intel® Xeon® Platinum 8460Y+, 300W, 40C	●●	●●	●●	●●	●●	●-	●-	●-
Intel® Xeon® Platinum 8452Y, 300W, 36C	●●	●●	●●	●●	●●	●-	●-	●-
Intel® Xeon® Gold 6454S, 270W, 32C	●●	●●	●●	●●	●●	●●	●-	●-
Intel® Xeon® Platinum 8454H, 270W, 32C	●●	●●	●●	●●	●●	●●	●-	●-
Intel® Xeon® Gold 6430, 270W, 32C	●●	●●	●●	●●	●●	●●	●-	●-
Intel® Xeon® Platinum 8444H, 270W, 16C	●●	●●	●●	●●	●●	●●	●-	●-
Intel® Xeon® Gold 6414U, 250W, 32C	●●	●●	●●	●●	●●	●●	●-	●-
Intel® Xeon® Platinum 8450H, 250W, 28C	●●	●●	●●	●●	●●	●●	●-	●-
Intel® Xeon® Platinum 8462Y+, 300W, 32C	●●	●●	●●	●●	●●	●-	●-	○-
Intel® Xeon® Gold 6444Y, 270W, 16C	●●	●●	●●	●●	●●	●○	●-	○-
Intel® Xeon® Gold 6448H, 250W, 32C	●●	●●	●●	●●	●●	●●	●-	●-
Intel® Xeon® Gold 6448Y, 225W, 32C	●●	●●	●●	●●	●●	●●	●●	●-
Intel® Xeon® Gold 6442Y, 225W, 24C	●●	●●	●●	●●	●●	●●	●●	●-
Intel® Xeon® Gold 6438M, 205W, 32C	●●	●●	●●	●●	●●	●●	●●	●-
Intel® Xeon® Gold 6438N, 205W, 32C	●●	●●	●●	●●	●●	●●	●●	●-
Intel® Xeon® Gold 6438Y+, 205W, 32C	●●	●●	●●	●●	●●	●●	●●	●-
Intel® Xeon® Gold 5420+, 205W, 28C	●●	●●	●●	●●	●●	●●	●●	●-
Intel® Xeon® Gold 6434, 195W, 8C	●●	●●	●●	●●	●●	●○	●○	○-
Intel® Xeon® Gold 6434H, 195W, 8C	●●	●●	●●	●●	●●	●○	●○	○-
Intel® Xeon® Gold 6428N, 185W, 32C	●●	●●	●●	●●	●●	●●	●●	●-
Intel® Xeon® Gold 6421N, 185W, 32C	●●	●●	●●	●●	●●	●●	●●	●-
Intel® Xeon® Gold 5418Y, 185W, 24C	●●	●●	●●	●●	●●	●●	●●	●-

Intel® Server System M50FCP2UR Technical Product Specification

Intel® Xeon® Gold 6418H, 185W, 24C	••	••	••	••	••	••	••	•-
Intel® Xeon® Gold 5412U, 185W, 24C	••	••	••	••	••	••	••	•-
Intel® Xeon® Gold 6426Y, 185W, 16C	••	••	••	••	••	••	••	•-
Intel® Xeon® Gold 5418N, 165W, 24C	••	••	••	••	••	••	••	••
Intel® Xeon® Gold 5411N, 165W, 24C	••	••	••	••	••	••	••	••
Intel® Xeon® Silver 4416+, 165W, 20C	••	••	••	••	••	••	••	••
Intel® Xeon® Gold 6416H, 165W, 18C	••	••	••	••	••	••	••	••
Intel® Xeon® Gold 5416S, 150W, 16C	••	••	••	••	••	••	••	••
Intel® Xeon® Silver 4410Y, 150W, 12C	••	••	••	••	••	••	••	••
Intel® Xeon® Gold 5415+, 150W, 8C	••	••	••	••	••	••	••	••
Intel® Xeon® Bronze 3408U, 125W, 8C	••	••	••	••	••	••	••	••
Intel® Xeon® Silver 4410T, 150W, 10C	••	••	••	••	••	••	••	••
<b>Memory Type</b>	<b>Memory Support</b>							
DDR5, DRx8, 1x, 1DPC	••	••	••	••	••	••	••	••
DDR5, DRx4, 1x, 1DPC	••	••	••	••	••	••	••	•○
DDR5, QRx4, 1x, 1DPC	••	••	••	••	••	••	•○	○○
DDR5, DRx8, 1x, 2DPC	••	••	••	••	••	••	••	••
DDR5, DRx4, 1x, 2DPC	••	••	••	••	••	••	••	••
DDR5, QRx4, 1x, 2DPC	••	••	••	••	••	••	••	••
DDR5, DRx8, 2x, 1DPC	••	••	••	••	••	••	••	••
DDR5, DRx4, 2x, 1DPC	••	••	••	••	••	••	••	••
DDR5, QRx4, 2x, 1DPC	••	••	••	••	••	••	••	••
DDR5, DRx8, 2x, 2DPC	••	••	••	••	••	••	••	••
DDR5, DRx4, 2x, 2DPC	••	••	••	••	••	••	••	••
DDR5, QRx4, 2x, 2DPC	••	••	••	••	••	••	••	••

<b>PCI Card Cooling</b>	<b>Supported Thermal Level</b>							
Riser 1 slot 1	LEVEL7 / LEVEL7	LEVEL7 / LEVEL7	LEVEL7 / LEVEL7	LEVEL7 / LEVEL7	LEVEL7 / LEVEL7	LEVEL7 / LEVEL7	LEVEL6 / LEVEL6	LEVEL6 / LEVEL6
Riser 1 slot 2	LEVEL7 / LEVEL7	LEVEL7 / LEVEL6	LEVEL7 / LEVEL6	LEVEL7 / LEVEL6	LEVEL7 / LEVEL6	LEVEL7 / LEVEL6	LEVEL6 / LEVEL5	LEVEL6 / LEVEL5
Riser 1 slot 3	LEVEL7 / LEVEL7	LEVEL7 / LEVEL7	LEVEL7 / LEVEL7	LEVEL7 / LEVEL7	LEVEL7 / LEVEL7	LEVEL7 / LEVEL6	LEVEL6 / LEVEL6	LEVEL5 / LEVEL5
Riser 2 slot 1	LEVEL7 / LEVEL7	LEVEL7 / LEVEL7	LEVEL7 / LEVEL6	LEVEL7 / LEVEL6	LEVEL7 / LEVEL6	LEVEL7 / LEVEL6	LEVEL6 / LEVEL6	LEVEL6 / LEVEL4
Riser 2 slot 2	LEVEL7 / LEVEL7	LEVEL7 / LEVEL7	LEVEL7 / LEVEL7	LEVEL7 / LEVEL7	LEVEL7 / LEVEL7	LEVEL7 / LEVEL6	LEVEL6 / LEVEL6	LEVEL5 / LEVEL5
Riser 2 slot 3	LEVEL7 / LEVEL7	LEVEL7 / LEVEL7	LEVEL7 / LEVEL7	LEVEL7 / LEVEL7	LEVEL7 / LEVEL6	LEVEL7 / LEVEL6	LEVEL6 / LEVEL6	LEVEL5 / LEVEL5
Riser 3 slot 1	LEVEL7 / LEVEL7	LEVEL7 / LEVEL7	LEVEL7 / LEVEL7	LEVEL7 / LEVEL7	LEVEL6 / LEVEL6	LEVEL6 / LEVEL6	LEVEL6 / LEVEL5	LEVEL5 / LEVEL4
Riser 3 slot 2	LEVEL7 / LEVEL7	LEVEL7 / LEVEL7	LEVEL7 / LEVEL7	LEVEL7 / LEVEL7	LEVEL6 / LEVEL6	LEVEL6 / LEVEL6	LEVEL6 / LEVEL6	LEVEL5 / LEVEL5
<b>3.5" SAS/SATA SSD</b>	<b>3.5" SAS/SATA SSD Support</b>							
Rated to 60C	-	-	-	-	-	-	-	-
<b>2.5" PCIe NVMe SSD</b>	<b>2.5" PCIe NVMe SSD Support</b>							
NVMe TDP = 25W, Rated to 70C	●●	●●	●●	●●	●●	●●	●○	-
<b>GPGPU card type</b>	<b>GPGPU card Support</b>							
Nvidia DW GPGPU - A16/A30/A40/A100-40G/A100-80G/H100	-	-	-	-	-	-	-	-
Intel® FPGA PAC D5005 - DW - 225W	-	-	-	-	-	-	-	-
PonteVecchio - DW - 300W	-	-	-	-	-	-	-	-
Intel ATS M1 - FH, 3/4 Length, Single Slot - 150W	-	-	-	-	-	-	-	-
Nvidia Tesla A2 - LP- 60W	●-	●-	●-	●-	-	-	-	-
Intel ATS M3 - LP- 75W	●-	●-	●-	●-	●-	●-	-	-
<b>Rear SSD above PSUs</b>	<b>Rear SSD Support</b>							



Intel® Server System M50FCP2UR Technical Product Specification

SATA SSD, Rated to 70C	●●	●●	●●	●●	●●	●●	●●	●○
<b>M.2 SSD</b>	<b>M.2 NVMe SSD Support</b>							
Micron 7400/7450 series (rated to 70C, TDP = 8W)	●●	●●	●●	●-	-	-	-	-
Other NVMe/SATA SSD in APlist (rated to 70C)	●●	●●	●●	●●	●●	●●	●○	●-
<b>PSU</b>	<b>PSU Support (Fan normal: 350W / Fan fail : 250W)</b>							
2100W	●●	●●	●●	●●	●●	●●	●○	○-
1600W	●●	●●	●●	●●	●●	●●	●○	○-
1300W	●●	●●	●●	●●	●●	●●	●○	○-
<b>OCP V3</b>	<b>OCP V3 Support</b>							
OCP 25W w/ class-2 QSFP	●●	●●	●●	●●	●●	●●	●○	-
<b>Battery Backup</b>	<b>Battery Backup Support</b>							
BBU inlet (rated to 45C)	●●	●●	●●	●●	●○	●○	○-	○-

**Table 56. Thermal Configuration Matrix with Dual 4<sup>th</sup> Gen Processors Installed – Normal Operating Mode (Table 2 of 4) (M50FCP2UR x16 Drive with 1U Heat Sink)**

Intel® Server M50FCPR2UR208x16, 1U Heatsink, Air-cooled								
Max Ambient Temperature	15°C	20°C	25°C	27°C	32°C	35°C	40°C	45°C
<b>CPU SKU</b>	<b>CPU Support (TDP 205W)</b>							
Intel® Xeon® Gold 6438M, 205W, 32C	●●	●●	●●	●●	●○	●○	●-	○-
Intel® Xeon® Gold 6438N, 205W, 32C	●●	●●	●●	●●	●○	●○	●-	○-
Intel® Xeon® Gold 6438Y+, 205W, 32C	●●	●●	●○	●○	●○	●○	○-	-
Intel® Xeon® Gold 5420+, 205W, 28C	●●	●●	●●	●●	●○	●○	●-	○-
Intel® Xeon® Gold 6434, 195W, 8C	●●	●○	●○	○○	○○	-	-	-

Intel® Server System M50FCP2UR Technical Product Specification

Intel® Xeon® Gold 6434H, 195W, 8C	●●	●○	●○	○○	○○	-	-	-
Intel® Xeon® Gold 6428N, 185W, 32C	●●	●●	●●	●●	●●	●●	●-	●-
Intel® Xeon® Gold 6421N, 185W, 32C	●●	●●	●●	●●	●●	●●	●-	●-
Intel® Xeon® Gold 5418Y, 185W, 24C	●●	●●	●●	●●	●●	●○	●-	○-
Intel® Xeon® Gold 6418H, 185W, 24C	●●	●●	●●	●●	●●	●○	●-	○-
Intel® Xeon® Gold 5412U, 185W, 24C	●●	●●	●●	●●	●●	●○	●-	○-
Intel® Xeon® Gold 6426Y, 185W, 16C	●●	●●	●●	●●	●●	●○	●-	○-
Intel® Xeon® Gold 5418N, 165W, 24C	●●	●●	●●	●●	●●	●●	●○	●-
Intel® Xeon® Gold 5411N, 165W, 24C	●●	●●	●●	●●	●●	●●	●○	●-
Intel® Xeon® Silver 4416+, 165W, 20C	●●	●●	●●	●●	●●	●●	●○	●-
Intel® Xeon® Gold 6416H, 165W, 18C	●●	●●	●●	●●	●●	●●	●○	●-
Intel® Xeon® Gold 5416S, 150W, 16C	●●	●●	●●	●●	●●	●●	●○	●-
Intel® Xeon® Silver 4410Y, 150W, 12C	●●	●●	●●	●●	●●	●●	●○	●-
Intel® Xeon® Gold 5415+, 150W, 8C	●●	●●	●●	●●	●●	●●	●○	●-
Intel® Xeon® Bronze 3408U, 125W, 8C	●●	●●	●●	●●	●●	●●	●●	●○
Intel® Xeon® Silver 4410T, 150W, 10C	●●	●●	●●	●●	●●	●●	●●	●-
<b>Memory Type</b>	<b>Memory Support</b>							
DDR5, DRx8, 1x, 1DPC	●●	●●	●●	●●	●●	●●	●●	●○
DDR5, DRx4, 1x, 1DPC	●●	●●	●○	●○	●○	●○	●○	●○
DDR5, QRx4, 1x, 1DPC	●○	●○	●○	●○	●○	●○	●○	○-
DDR5, DRx8, 1x, 2DPC	●●	●●	●●	●●	●●	●●	●●	●●
DDR5, DRx4, 1x, 2DPC	●●	●●	●●	●●	●●	●●	●●	●○
DDR5, QRx4, 1x, 2DPC	●●	●●	●●	●●	●●	●●	●○	●○
DDR5, DRx8, 2x, 1DPC	●●	●●	●●	●●	●●	●●	●●	●●
DDR5, DRx4, 2x, 1DPC	●●	●●	●●	●●	●○	●○	●○	●○
DDR5, QRx4, 2x, 1DPC	●●	●●	●○	●○	●○	●○	●○	●○

Intel® Server System M50FCP2UR Technical Product Specification

DDR5, DRx8, 2x, 2DPC	●●	●●	●●	●●	●●	●●	●●	●●
DDR5, DRx4, 2x, 2DPC	●●	●●	●●	●●	●●	●●	●●	●●
DDR5, QRx4, 2x, 2DPC	●●	●●	●●	●●	●●	●●	●●	●○
<b>PCI Card Cooling</b>	<b>Supported Thermal Level</b>							
Riser 1 slot 1	LEVEL7 / LEVEL7	LEVEL7 / LEVEL7	LEVEL7 / LEVEL7	LEVEL7 / LEVEL7	LEVEL7 / LEVEL7	LEVEL7 / LEVEL6	LEVEL6 / LEVEL6	LEVEL6 / LEVEL5
Riser 1 slot 2	LEVEL7 / LEVEL7	LEVEL7 / LEVEL7	LEVEL7 / LEVEL7	LEVEL7 / LEVEL7	LEVEL7 / LEVEL7	LEVEL6 / LEVEL6	LEVEL6 / LEVEL6	LEVEL5 / LEVEL5
Riser 1 slot 3	LEVEL7 / LEVEL7	LEVEL7 / LEVEL7	LEVEL7 / LEVEL7	LEVEL7 / LEVEL7	LEVEL7 / LEVEL7	LEVEL6 / LEVEL6	LEVEL6 / LEVEL6	LEVEL5 / LEVEL5
Riser 2 slot 1	LEVEL7 / LEVEL5	LEVEL7 / LEVEL5	LEVEL7 / LEVEL5	LEVEL6 / LEVEL4	LEVEL6 / LEVEL4	LEVEL6 / LEVEL4	LEVEL6 / LEVEL3	LEVEL6 / LEVEL3
Riser 2 slot 2	LEVEL7 / LEVEL7	LEVEL7 / LEVEL7	LEVEL7 / LEVEL7	LEVEL7 / LEVEL7	LEVEL7 / LEVEL7	LEVEL6 / LEVEL6	LEVEL6 / LEVEL6	LEVEL5 / LEVEL5
Riser 2 slot 3	LEVEL7 / LEVEL7	LEVEL7 / LEVEL7	LEVEL7 / LEVEL7	LEVEL7 / LEVEL7	LEVEL7 / LEVEL7	LEVEL6 / LEVEL6	LEVEL6 / LEVEL6	LEVEL5 / LEVEL5
Riser 3 slot 1	LEVEL7 / LEVEL7	LEVEL7 / LEVEL7	LEVEL7 / LEVEL7	LEVEL7 / LEVEL7	LEVEL7 / LEVEL6	LEVEL6 / LEVEL6	LEVEL6 / LEVEL5	LEVEL6 / LEVEL4
Riser 3 slot 2	LEVEL7 / LEVEL7	LEVEL7 / LEVEL7	LEVEL7 / LEVEL7	LEVEL7 / LEVEL6	LEVEL7 / LEVEL6	LEVEL6 / LEVEL6	LEVEL6 / LEVEL5	LEVEL5 / LEVEL4
<b>3.5" SAS/SATA SSD</b>	<b>3.5" SAS/SATA SSD Support</b>							
Rated to 60C	-	-	-	-	-	-	-	-
<b>2.5" PCIe NVMe SSD</b>	<b>2.5" PCIe NVMe SSD Support</b>							
NVMe TDP = 25W, Rated to 70C	●●	●●	●●	●●	●●	●●	●○	-
<b>GPGPU card type</b>	<b>GPGPU card Support</b>							
Nvidia DW GPGPU - A16/A30/A40/A100-40G/A100-80G/H100	●-	●-	●-	●-	●-	●-	-	-
Intel® FPGA PAC D5005 - DW - 225W	●-	●-	●-	●-	●-	●-	-	-
PonteVecchio - DW - 300W	●-	●-	●-	●-	●-	-	-	-
Intel ATS M1 - FH, 3/4 Length, Single Slot - 150W	●-	●-	●-	●-	●-	●-	-	-
Nvidia Tesla A2 - LP- 60W	●-	●-	●-	-	-	-	-	-

Intel® Server System M50FCP2UR Technical Product Specification

Intel ATS M3 - LP- 75W	● -	● -	● -	● -	● -	● -	-	-
<b>Rear SSD above PSUs</b>	<b>Rear SSD Support</b>							
SATA SSD, Rated to 70C	● ●	● ●	● ●	● ●	● ●	● ●	● ●	● ○
<b>M.2 SSD</b>	<b>M.2 NVMe SSD Support</b>							
Micron 7400/7450 series (rated to 70C, TDP = 8W)	● ●	● ●	● ●	● -	● -	-	-	-
Other NVMe/SATA SSD in APlist (rated to 70C)	● ●	● ●	● ●	● ●	● ●	● ●	● ○	● -
<b>PSU</b>	<b>PSU Support (Fan normal: 205W / Fan fail : 185W)</b>							
2100W	● ●	● ●	● ●	● ●	● ●	● ●	● ○	● -
1600W	● ●	● ●	● ●	● ●	● ●	● ●	● ○	● -
1300W	● ●	● ●	● ●	● ●	● ●	● ●	● ○	● -
<b>OCP V3</b>	<b>OCP V3 Support</b>							
OCP 25W w/ class-2 QSFP	● ●	● ●	● ●	● ●	● ●	● ●	● ○	-
<b>Battery Backup</b>	<b>Battery Backup Support</b>							
BBU inlet (rated to 45C)	● ●	● ●	● ●	● ●	● ○	● ○	○ -	○ -

**Table 57. Thermal Configuration Matrix with Dual 5<sup>th</sup> Gen Processors Installed – Normal Operating Mode (Table 3 of 4) (M50FCP2UR x16 Drive with 2U Heat Sink)**

Intel® Server M50FCPR2UR208x16, 2U Heatsink, Air-cooled								
Max Ambient Temperature	15°C	20°C	25°C	27°C	32°C	35°C	40°C	45°C
<b>CPU SKU</b>	<b>CPU Support (TDP 350W)</b>							
Intel® Xeon® Platinum 8592+, 350W, 64C	● ●	● ●	● ●	● ●	● -	● -	● -	-
Intel® Xeon® Platinum 8580, 350W, 60C	● ●	● ●	● ●	● ●	● -	● -	● -	-
Intel® Xeon® Platinum 8570, 350W, 56C	● ●	● ●	● ●	● ●	● -	● -	● -	-
Intel® Xeon® Platinum 8558P, 350W, 48C	● ●	● ●	● ●	● ●	● -	● -	● -	-

Intel® Server System M50FCP2UR Technical Product Specification

Intel® Xeon® Platinum 8568Y+, 350W, 48C	●●	●●	●●	●●	●-	●-	●-	-
Intel® Xeon® Platinum 8592V, 330W, 64C	●●	●●	●●	●●	●-	●-	●-	○-
Intel® Xeon® Platinum 8558, 330W, 48C	●●	●●	●●	●●	●-	●-	●-	○-
Intel® Xeon® Platinum 8571N, 300W, 52C	●●	●●	●●	●●	●●	●-	●-	●-
Intel® Xeon® Platinum 8558U, 300W, 48C	●●	●●	●●	●●	●●	●-	●-	●-
Intel® Xeon® Platinum 8581V, 270W, 60C	●●	●●	●●	●●	●●	●●	●-	●-
Intel® Xeon® Gold 6554S, 270W, 36C	●●	●●	●●	●●	●●	●●	●-	●-
Intel® Xeon® Gold 6530, 270W, 32C	●●	●●	●●	●●	●●	●●	●-	●-
Intel® Xeon® Platinum 8562Y+, 300W, 32C	●●	●●	●●	●●	●●	●-	●-	○-
Intel® Xeon® Gold 6544Y, 270W, 16C	●●	●●	●●	●●	●●	●○	●-	○-
Intel® Xeon® Gold 6548Y+, 250W, 32C	●●	●●	●●	●●	●●	●●	●-	●-
Intel® Xeon® Gold 6548N, 250W, 32C	●●	●●	●●	●●	●●	●●	●-	●-
Intel® Xeon® Gold 6542Y, 250W, 24C	●●	●●	●●	●●	●●	●●	●-	●-
Intel® Xeon® Gold 6538Y+, 225W, 32C	●●	●●	●●	●●	●●	●●	●●	●-
Intel® Xeon® Gold 6538N, 205W, 32C	●●	●●	●●	●●	●●	●●	●●	●-
Intel® Xeon® Gold 5520+, 205W, 28C	●●	●●	●●	●●	●●	●●	●●	●-
Intel® Xeon® Gold 6526Y, 195W, 16C	●●	●●	●●	●●	●●	●●	●●	●-
Intel® Xeon® Gold 6534, 195W, 8C	●●	●●	●●	●●	●●	●○	●○	○-
Intel® Xeon® Gold 5512U, 185W, 28C	●●	●●	●●	●●	●●	●●	●●	●-
Intel® Xeon® Silver 4516Y+, 185W, 24C	●●	●●	●●	●●	●●	●●	●●	●-
Intel® Xeon® Gold 5515+, 165W, 8C	●●	●●	●●	●●	●●	●●	●●	●●
Intel® Xeon® Gold 4514Y, 150W, 16C	●●	●●	●●	●●	●●	●●	●●	●●
Intel® Xeon® Silver 4510, 150W, 12C	●●	●●	●●	●●	●●	●●	●●	●●
<b>Memory Type</b>	<b>Memory Support</b>							
DDR5, DRx8, 1x, 1DPC	●●	●●	●●	●●	●●	●●	●●	●●
DDR5, DRx4, 1x, 1DPC	●●	●●	●●	●●	●●	●●	●●	●○

Intel® Server System M50FCP2UR Technical Product Specification

DDR5, QRx4, 1x, 1DPC	●●	●●	●●	●●	●●	●●	●○	○○
DDR5, DRx8, 1x, 2DPC	●●	●●	●●	●●	●●	●●	●●	●●
DDR5, DRx4, 1x, 2DPC	●●	●●	●●	●●	●●	●●	●●	●●
DDR5, QRx4, 1x, 2DPC	●●	●●	●●	●●	●●	●●	●●	●●
DDR5, DRx8, 2x, 1DPC	●●	●●	●●	●●	●●	●●	●●	●●
DDR5, DRx4, 2x, 1DPC	●●	●●	●●	●●	●●	●●	●●	●●
DDR5, QRx4, 2x, 1DPC	●●	●●	●●	●●	●●	●●	●●	●●
DDR5, DRx8, 2x, 2DPC	●●	●●	●●	●●	●●	●●	●●	●●
DDR5, DRx4, 2x, 2DPC	●●	●●	●●	●●	●●	●●	●●	●●
DDR5, QRx4, 2x, 2DPC	●●	●●	●●	●●	●●	●●	●●	●●
<b>PCI Card Cooling</b>	<b>Supported Thermal Level</b>							
Riser 1 slot 1	LEVEL7 / LEVEL7	LEVEL7 / LEVEL7	LEVEL7 / LEVEL7	LEVEL7 / LEVEL7	LEVEL7 / LEVEL7	LEVEL7 / LEVEL7	LEVEL6 / LEVEL6	LEVEL6 / LEVEL6
Riser 1 slot 2	LEVEL7 / LEVEL7	LEVEL7 / LEVEL6	LEVEL7 / LEVEL6	LEVEL7 / LEVEL6	LEVEL7 / LEVEL6	LEVEL7 / LEVEL6	LEVEL6 / LEVEL5	LEVEL6 / LEVEL5
Riser 1 slot 3	LEVEL7 / LEVEL7	LEVEL7 / LEVEL7	LEVEL7 / LEVEL7	LEVEL7 / LEVEL7	LEVEL7 / LEVEL7	LEVEL6 / LEVEL6	LEVEL6 / LEVEL6	LEVEL5 / LEVEL5
Riser 2 slot 1	LEVEL7 / LEVEL7	LEVEL7 / LEVEL7	LEVEL7 / LEVEL6	LEVEL7 / LEVEL6	LEVEL7 / LEVEL6	LEVEL7 / LEVEL6	LEVEL6 / LEVEL6	LEVEL6 / LEVEL4
Riser 2 slot 2	LEVEL7 / LEVEL7	LEVEL7 / LEVEL7	LEVEL7 / LEVEL7	LEVEL7 / LEVEL7	LEVEL7 / LEVEL7	LEVEL6 / LEVEL6	LEVEL6 / LEVEL6	LEVEL5 / LEVEL5
Riser 2 slot 3	LEVEL7 / LEVEL7	LEVEL7 / LEVEL7	LEVEL7 / LEVEL7	LEVEL7 / LEVEL7	LEVEL7 / LEVEL6	LEVEL6 / LEVEL6	LEVEL6 / LEVEL6	LEVEL5 / LEVEL5
Riser 3 slot 1	LEVEL7 / LEVEL7	LEVEL7 / LEVEL7	LEVEL7 / LEVEL7	LEVEL7 / LEVEL7	LEVEL6 / LEVEL6	LEVEL6 / LEVEL6	LEVEL6 / LEVEL5	LEVEL5 / LEVEL4
Riser 3 slot 2	LEVEL7 / LEVEL7	LEVEL7 / LEVEL7	LEVEL7 / LEVEL7	LEVEL7 / LEVEL7	LEVEL6 / LEVEL6	LEVEL6 / LEVEL6	LEVEL6 / LEVEL6	LEVEL5 / LEVEL5
<b>3.5" SAS/SATA SSD</b>	<b>3.5" SAS/SATA SSD Support</b>							
Rated to 60C	-	-	-	-	-	-	-	-
<b>2.5" PCIe NVMe SSD</b>	<b>2.5" PCIe NVMe SSD Support</b>							

Intel® Server System M50FCP2UR Technical Product Specification

NVMe TDP = 25W, Rated to 70C	●●	●●	●●	●●	●●	●●	●○	-
<b>GPGPU card type</b>	<b>GPGPU card Support</b>							
Nvidia DW GPGPU - A16/A30/A40/A100-40G/A100-80G/H100	-	-	-	-	-	-	-	-
Intel® FPGA PAC D5005 - DW - 225W	-	-	-	-	-	-	-	-
PonteVecchio - DW - 300W	-	-	-	-	-	-	-	-
Intel ATS M1 - FH, 3/4 Length, Single Slot - 150W	-	-	-	-	-	-	-	-
Nvidia Tesla A2 - LP- 60W	●-	●-	●-	●-	-	-	-	-
Intel ATS M3 - LP- 75W	●-	●-	●-	●-	●-	●-	-	-
<b>Rear SSD above PSUs</b>	<b>Rear SSD Support</b>							
SATA SSD, Rated to 70C	●●	●●	●●	●●	●●	●●	●●	●○
<b>M.2 SSD</b>	<b>M.2 NVMe SSD Support</b>							
Micron 7400/7450 series (rated to 70C, TDP = 8W)	●●	●●	●●	●-	-	-	-	-
Other NVMe/SATA SSD in APlist (rated to 70C)	●●	●●	●●	●●	●●	●●	●○	●-
<b>PSU</b>	<b>PSU Support (Fan normal : 350W / Fan fail : 250W)</b>							
2100W	●●	●●	●●	●●	●●	●●	●○	○-
1600W	●●	●●	●●	●●	●●	●●	●○	○-
1300W	●●	●●	●●	●●	●●	●●	●○	○-
<b>OCP V3</b>	<b>OCP V3 Support</b>							
OCP 25W w/ class-2 QSFP	●●	●●	●●	●●	●●	●●	●○	-
<b>Battery Backup</b>	<b>Battery Backup Support</b>							
BBU inlet (rated to 45C)	●●	●●	●●	●●	●○	●○	○-	○-

**Table 58. Thermal Configuration Matrix with Dual 5<sup>th</sup> Gen Processors Installed Normal Operating Mode (Table 4 of 4) (M50FCP2UR208 x16 Drive with 1U Heat Sink)**

Intel® Server M50FCP2UR208x16, 1U Heatsink, Air-cooled								
Max Ambient Temperature	15°C	20°C	25°C	27°C	32°C	35°C	40°C	45°C
<b>CPU SKU</b>	<b>CPU Support (TDP 205W)</b>							
Intel® Xeon® Gold 6538N, 205W, 32C	●●	●●	●●	●●	●○	●○	●-	○-
Intel® Xeon® Gold 5520+, 205W, 28C	●●	●●	●●	●●	●○	●○	●-	○-
Intel® Xeon® Gold 6526Y, 195W, 16C	●●	●●	●●	●●	●●	●○	●-	○-
Intel® Xeon® Gold 6534, 195W, 8C	●○	●○	●○	○○	○○	-	-	-
Intel® Xeon® Gold 5512U, 185W, 28C	●●	●●	●●	●●	●●	●●	●-	●-
Intel® Xeon® Silver 4516Y+, 185W, 24C	●●	●●	●●	●●	●●	●○	●-	○-
Intel® Xeon® Gold 5515+, 165W, 8C	●●	●●	●●	●●	●●	●○	●○	○-
Intel® Xeon® Gold 4514Y, 150W, 16C	●●	●●	●●	●●	●●	●●	●○	●-
Intel® Xeon® Silver 4510, 150W, 12C	●●	●●	●●	●●	●●	●●	●○	●-
<b>Memory Type</b>	<b>Memory Support</b>							
DDR5, DRx8, 1x, 1DPC	●●	●●	●●	●●	●●	●●	●●	●○
DDR5, DRx4, 1x, 1DPC	●●	●●	●○	●○	●○	●○	●○	●○
DDR5, QRx4, 1x, 1DPC	●○	●○	●○	●○	●○	●○	●○	○-
DDR5, DRx8, 1x, 2DPC	●●	●●	●●	●●	●●	●●	●●	●●
DDR5, DRx4, 1x, 2DPC	●●	●●	●●	●●	●●	●●	●●	●○
DDR5, QRx4, 1x, 2DPC	●●	●●	●●	●●	●●	●●	●○	●○
DDR5, DRx8, 2x, 1DPC	●●	●●	●●	●●	●●	●●	●●	●●
DDR5, DRx4, 2x, 1DPC	●●	●●	●●	●●	●○	●○	●○	●○
DDR5, QRx4, 2x, 1DPC	●●	●●	●○	●○	●○	●○	●○	●○
DDR5, DRx8, 2x, 2DPC	●●	●●	●●	●●	●●	●●	●●	●●
DDR5, DRx4, 2x, 2DPC	●●	●●	●●	●●	●●	●●	●●	●●



Intel® Server System M50FCP2UR Technical Product Specification

DDR5, QRx4, 2x, 2DPC	●●	●●	●●	●●	●●	●●	●●	●○
<b>PCI Card Cooling</b>	<b>Supported Thermal Level</b>							
Riser 1 slot 1	LEVEL7 / LEVEL7	LEVEL7 / LEVEL7	LEVEL7 / LEVEL7	LEVEL7 / LEVEL7	LEVEL7 / LEVEL7	LEVEL7 / LEVEL6	LEVEL6 / LEVEL6	LEVEL6 / LEVEL5
Riser 1 slot 2	LEVEL7 / LEVEL7	LEVEL7 / LEVEL7	LEVEL7 / LEVEL7	LEVEL7 / LEVEL7	LEVEL7 / LEVEL7	LEVEL7 / LEVEL7	LEVEL6 / LEVEL6	LEVEL6 / LEVEL5
Riser 1 slot 3	LEVEL7 / LEVEL7	LEVEL7 / LEVEL7	LEVEL7 / LEVEL7	LEVEL7 / LEVEL7	LEVEL7 / LEVEL7	LEVEL7 / LEVEL7	LEVEL6 / LEVEL6	LEVEL6 / LEVEL5
Riser 2 slot 1	LEVEL7 / LEVEL5	LEVEL7 / LEVEL5	LEVEL7 / LEVEL5	LEVEL6 / LEVEL4	LEVEL6 / LEVEL4	LEVEL6 / LEVEL4	LEVEL6 / LEVEL3	LEVEL6 / LEVEL3
Riser 2 slot 2	LEVEL7 / LEVEL7	LEVEL7 / LEVEL7	LEVEL7 / LEVEL7	LEVEL7 / LEVEL7	LEVEL7 / LEVEL7	LEVEL7 / LEVEL7	LEVEL6 / LEVEL6	LEVEL6 / LEVEL5
Riser 2 slot 3	LEVEL7 / LEVEL7	LEVEL7 / LEVEL7	LEVEL7 / LEVEL7	LEVEL7 / LEVEL7	LEVEL7 / LEVEL7	LEVEL7 / LEVEL7	LEVEL6 / LEVEL6	LEVEL6 / LEVEL5
Riser 3 slot 1	LEVEL7 / LEVEL7	LEVEL7 / LEVEL7	LEVEL7 / LEVEL7	LEVEL7 / LEVEL7	LEVEL7 / LEVEL6	LEVEL7 / LEVEL6	LEVEL6 / LEVEL5	LEVEL6 / LEVEL4
Riser 3 slot 2	LEVEL7 / LEVEL7	LEVEL7 / LEVEL7	LEVEL7 / LEVEL7	LEVEL7 / LEVEL6	LEVEL7 / LEVEL6	LEVEL7 / LEVEL6	LEVEL6 / LEVEL5	LEVEL6 / LEVEL4
<b>3.5" SAS/SATA SSD</b>	<b>3.5" SAS/SATA SSD Support</b>							
Rated to 60C	-	-	-	-	-	-	-	-
<b>2.5" PCIe NVMe SSD</b>	<b>2.5" PCIe NVMe SSD Support</b>							
NVMe TDP = 25W, Rated to 70C	●●	●●	●●	●●	●●	●●	●○	-
<b>GPGPU card type</b>	<b>GPGPU card Support</b>							
Nvidia DW GPGPU - A16/A30/A40/A100-40G/A100-80G/H100	●-	●-	●-	●-	●-	●-	-	-
Intel® FPGA PAC D5005 - DW - 225W	●-	●-	●-	●-	●-	●-	-	-
PonteVecchio - DW - 300W	●-	●-	●-	●-	●-	-	-	-
Intel ATS M1 - FH, 3/4 Length, Single Slot - 150W	●-	●-	●-	●-	●-	●-	-	-
Nvidia Tesla A2 - LP- 60W	●-	●-	●-	-	-	-	-	-
Intel ATS M3 - LP- 75W	●-	●-	●-	●-	●-	●-	-	-

Rear SSD above PSUs	Rear SSD Support							
SATA SSD, Rated to 70C	●●	●●	●●	●●	●●	●●	●●	●○
M.2 SSD	M.2 NVMe SSD Support							
Micron 7400/7450 series (rated to 70C, TDP = 8W)	●●	●●	●●	●-	●-	-	-	-
Other NVMe/SATA SSD in APlist (rated to 70C)	●●	●●	●●	●●	●●	●●	●○	●-
PSU	PSU Support (Fan normal: 205W / Fan fail : 185W)							
2100W	●●	●●	●●	●●	●●	●●	●○	●-
1600W	●●	●●	●●	●●	●●	●●	●○	●-
1300W	●●	●●	●●	●●	●●	●●	●○	●-
OCP V3	OCP V3 Support							
OCP 25W w/ class-2 QSFP	●●	●●	●●	●●	●●	●●	●○	-
Battery Backup	Battery Backup Support							
BBU inlet (rated to 45C)	●●	●●	●●	●●	●○	●○	○-	○-

**Table 59. Thermal Configuration Matrix with Dual 4<sup>th</sup> Gen Processors Installed Normal Operating Mode (Table 1 of 4) (M50FCP2UR x8 Drive with 2U Heat Sink)**

Intel® Server M50FCPR2UR208, 2U Heatsink, Air-cooled								
Max Ambient Temperature	15°C	20°C	25°C	27°C	32°C	35°C	40°C	45°C
CPU SKU	CPU Support (TDP 350W)							
Intel® Xeon® Platinum 8490H, 350W, 60C	●●	●●	●●	●●	●●	●●	●-	●-
Intel® Xeon® Platinum 8480+, 350W, 56C	●●	●●	●●	●●	●●	●●	●-	●-
Intel® Xeon® Platinum 8470Q, 350W, 52C	●●	●○	●○	●○	○○	○○	-	-
Intel® Xeon® Platinum 8470, 350W, 52C	●●	●●	●●	●●	●●	●●	●-	●-
Intel® Xeon® Platinum 8468, 350W, 48C	●●	●●	●●	●●	●●	●●	●-	●-

Intel® Server System M50FCP2UR Technical Product Specification

Intel® Xeon® Platinum 8458P, 350W, 44C	●●	●●	●●	●●	●●	●●	●-	●-
Intel® Xeon® Platinum 8468V, 330W, 48C	●●	●●	●●	●●	●●	●●	●○	●-
Intel® Xeon® Platinum 8468H, 330W, 48C	●●	●●	●●	●●	●●	●●	●○	●-
Intel® Xeon® Platinum 8460H, 330W, 40C	●●	●●	●●	●●	●●	●●	●○	●-
Intel® Xeon® Platinum 8471N, 300W, 52C	●●	●●	●●	●●	●●	●●	●●	●-
Intel® Xeon® Platinum 8470N, 300W, 52C	●●	●●	●●	●●	●●	●●	●●	●-
Intel® Xeon® Platinum 8461V, 300W, 48C	●●	●●	●●	●●	●●	●●	●●	●-
Intel® Xeon® Platinum 8460Y+, 300W, 40C	●●	●●	●●	●●	●●	●●	●●	●-
Intel® Xeon® Platinum 8452Y, 300W, 36C	●●	●●	●●	●●	●●	●●	●●	●-
Intel® Xeon® Gold 6454S, 270W, 32C	●●	●●	●●	●●	●●	●●	●●	●-
Intel® Xeon® Platinum 8454H, 270W, 32C	●●	●●	●●	●●	●●	●●	●●	●-
Intel® Xeon® Gold 6430, 270W, 32C	●●	●●	●●	●●	●●	●●	●●	●-
Intel® Xeon® Platinum 8444H, 270W, 16C	●●	●●	●●	●●	●●	●●	●●	●-
Intel® Xeon® Gold 6414U, 250W, 32C	●●	●●	●●	●●	●●	●●	●●	●●
Intel® Xeon® Platinum 8450H, 250W, 28C	●●	●●	●●	●●	●●	●●	●●	●●
Intel® Xeon® Gold 6458Q, 350W, 32C	●●	●○	●○	○○	○○	-	-	-
Intel® Xeon® Platinum 8462Y+, 300W, 32C	●●	●●	●●	●●	●●	●●	●○	●-
Intel® Xeon® Gold 6444Y, 270W, 16C	●●	●●	●●	●●	●●	●●	●○	●-
Intel® Xeon® Gold 6448H, 250W, 32C	●●	●●	●●	●●	●●	●●	●●	●●
Intel® Xeon® Gold 6448Y, 225W, 32C	●●	●●	●●	●●	●●	●●	●●	●●
Intel® Xeon® Gold 6442Y, 225W, 24C	●●	●●	●●	●●	●●	●●	●●	●●
Intel® Xeon® Gold 6438M, 205W, 32C	●●	●●	●●	●●	●●	●●	●●	●●
Intel® Xeon® Gold 6438N, 205W, 32C	●●	●●	●●	●●	●●	●●	●●	●●
Intel® Xeon® Gold 6438Y+, 205W, 32C	●●	●●	●●	●●	●●	●●	●●	●●
Intel® Xeon® Gold 5420+, 205W, 28C	●●	●●	●●	●●	●●	●●	●●	●●
Intel® Xeon® Gold 6434, 195W, 8C	●●	●●	●●	●●	●●	●●	●○	○○

Intel® Server System M50FCP2UR Technical Product Specification

Intel® Xeon® Gold 6434H, 195W, 8C	●●	●●	●●	●●	●●	●●	●○	○○
Intel® Xeon® Gold 6428N, 185W, 32C	●●	●●	●●	●●	●●	●●	●●	●●
Intel® Xeon® Gold 6421N, 185W, 32C	●●	●●	●●	●●	●●	●●	●●	●●
Intel® Xeon® Gold 5418Y, 185W, 24C	●●	●●	●●	●●	●●	●●	●●	●●
Intel® Xeon® Gold 6418H, 185W, 24C	●●	●●	●●	●●	●●	●●	●●	●●
Intel® Xeon® Gold 5412U, 185W, 24C	●●	●●	●●	●●	●●	●●	●●	●●
Intel® Xeon® Gold 6426Y, 185W, 16C	●●	●●	●●	●●	●●	●●	●●	●●
Intel® Xeon® Gold 5418N, 165W, 24C	●●	●●	●●	●●	●●	●●	●●	●●
Intel® Xeon® Gold 5411N, 165W, 24C	●●	●●	●●	●●	●●	●●	●●	●●
Intel® Xeon® Silver 4416+, 165W, 20C	●●	●●	●●	●●	●●	●●	●●	●●
Intel® Xeon® Gold 6416H, 165W, 18C	●●	●●	●●	●●	●●	●●	●●	●●
Intel® Xeon® Gold 5416S, 150W, 16C	●●	●●	●●	●●	●●	●●	●●	●●
Intel® Xeon® Silver 4410Y, 150W, 12C	●●	●●	●●	●●	●●	●●	●●	●●
Intel® Xeon® Gold 5415+, 150W, 8C	●●	●●	●●	●●	●●	●●	●●	●●
Intel® Xeon® Bronze 3408U, 125W, 8C	●●	●●	●●	●●	●●	●●	●●	●●
Intel® Xeon® Silver 4410T, 150W, 10C	●●	●●	●●	●●	●●	●●	●●	●●
<b>Memory Type</b>	<b>Memory Support</b>							
DDR5, DRx8, 1x, 1DPC	●●	●●	●●	●●	●●	●●	●●	●●
DDR5, DRx4, 1x, 1DPC	●●	●●	●●	●●	●●	●○	●○	●○
DDR5, QRx4, 1x, 1DPC	●●	●●	●●	●○	●○	●○	●○	●○
DDR5, DRx8, 1x, 2DPC	●●	●●	●●	●●	●●	●●	●●	●●
DDR5, DRx4, 1x, 2DPC	●●	●●	●●	●●	●●	●●	●●	●●
DDR5, QRx4, 1x, 2DPC	●●	●●	●●	●●	●●	●●	●●	●●
DDR5, DRx8, 2x, 1DPC	●●	●●	●●	●●	●●	●●	●●	●●
DDR5, DRx4, 2x, 1DPC	●●	●●	●●	●●	●●	●●	●●	●○
DDR5, QRx4, 2x, 1DPC	●●	●●	●●	●●	●●	●○	●○	●○

Intel® Server System M50FCP2UR Technical Product Specification

DDR5, DRx8, 2x, 2DPC	••	••	••	••	••	••	••	••
DDR5, DRx4, 2x, 2DPC	••	••	••	••	••	••	••	••
DDR5, QRx4, 2x, 2DPC	••	••	••	••	••	••	••	••
<b>PCI Card Cooling</b>	<b>Supported Thermal Level</b>							
Riser 1 slot 1	LEVEL7 / LEVEL7	LEVEL7 / LEVEL7	LEVEL7 / LEVEL7	LEVEL7 / LEVEL7	LEVEL7 / LEVEL7	LEVEL7 / LEVEL7	LEVEL6 / LEVEL6	LEVEL6 / LEVEL6
Riser 1 slot 2	LEVEL7 / LEVEL7	LEVEL7 / LEVEL6	LEVEL7 / LEVEL6	LEVEL7 / LEVEL6	LEVEL7 / LEVEL6	LEVEL7 / LEVEL6	LEVEL6 / LEVEL5	LEVEL6 / LEVEL5
Riser 1 slot 3	LEVEL7 / LEVEL7	LEVEL7 / LEVEL7	LEVEL7 / LEVEL7	LEVEL7 / LEVEL7	LEVEL7 / LEVEL7	LEVEL6 / LEVEL6	LEVEL6 / LEVEL6	LEVEL5 / LEVEL5
Riser 2 slot 1	LEVEL7 / LEVEL6	LEVEL7 / LEVEL6	LEVEL7 / LEVEL6	LEVEL7 / LEVEL6	LEVEL7 / LEVEL6	LEVEL7 / LEVEL5	LEVEL6 / LEVEL5	LEVEL6 / LEVEL3
Riser 2 slot 2	LEVEL7 / LEVEL7	LEVEL7 / LEVEL7	LEVEL7 / LEVEL7	LEVEL7 / LEVEL7	LEVEL7 / LEVEL7	LEVEL6 / LEVEL6	LEVEL6 / LEVEL6	LEVEL5 / LEVEL5
Riser 2 slot 3	LEVEL7 / LEVEL7	LEVEL7 / LEVEL7	LEVEL7 / LEVEL7	LEVEL7 / LEVEL7	LEVEL7 / LEVEL7	LEVEL6 / LEVEL6	LEVEL6 / LEVEL6	LEVEL5 / LEVEL5
Riser 3 slot 1	LEVEL7 / LEVEL7	LEVEL7 / LEVEL7	LEVEL7 / LEVEL7	LEVEL7 / LEVEL7	LEVEL7 / LEVEL6	LEVEL7 / LEVEL6	LEVEL6 / LEVEL5	LEVEL6 / LEVEL4
Riser 3 slot 2	LEVEL7 / LEVEL7	LEVEL7 / LEVEL7	LEVEL7 / LEVEL7	LEVEL7 / LEVEL7	LEVEL7 / LEVEL6	LEVEL7 / LEVEL6	LEVEL6 / LEVEL5	LEVEL6 / LEVEL4
<b>3.5" SAS/SATA SSD</b>	<b>3.5" SAS/SATA SSD Support</b>							
Rated to 60C	-	-	-	-	-	-	-	-
<b>2.5" PCIe NVMe SSD</b>	<b>2.5" PCIe NVMe SSD Support</b>							
NVMe TDP = 25W, Rated to 70C	••	••	••	••	••	••	○-	-
<b>GPGPU card type</b>	<b>GPGPU card Support</b>							
Nvidia DW GPGPU - A16/A30/A40/A100-40G/A100-80G/H100	-	-	-	-	-	-	-	-
Intel® FPGA PAC D5005 - DW - 225W	-	-	-	-	-	-	-	-
PonteVecchio - DW - 300W	-	-	-	-	-	-	-	-
Intel ATS M1 - FH, 3/4 Length, Single Slot - 150W	-	-	-	-	-	-	-	-
Nvidia Tesla A2 - LP- 60W	•-	•-	•-	•-	-	-	-	-

Intel® Server System M50FCP2UR Technical Product Specification

Intel ATS M3 - LP- 75W	● -	● -	● -	● -	● -	● -	-	-
<b>Rear SSD above PSUs</b>	<b>Rear SSD Support</b>							
SATA SSD, Rated to 70C	● ●	● ●	● ●	● ●	● ●	● ●	● ●	● ●
<b>M.2 SSD</b>	<b>M.2 NVMe SSD Support</b>							
Micron 7400/7450 series (rated to 70C, TDP = 8W)	● ●	● ●	● ●	● -	● -	● -	-	-
Other NVMe/SATA SSD in APlist (rated to 70C)	● ●	● ●	● ●	● ●	● ●	● ●	● ○	● ○
<b>PSU</b>	<b>PSU Support (Fan normal: 350W / Fan fail: 330W)</b>							
2100W	● ●	● ●	● ●	● ●	● ●	● ●	● ●	● -
1600W	● ●	● ●	● ●	● ●	● ●	● ●	● ●	● -
1300W	● ●	● ●	● ●	● ●	● ●	● ●	● ●	● -
<b>OCP V3</b>	<b>OCP V3 Support</b>							
OCP 25W w/ class-2 QSFP	● ●	● ●	● ●	● ●	● ●	● ●	● ○	-
<b>Battery Backup</b>	<b>Battery Backup Support</b>							
BBU inlet (rated to 45C)	● ●	● ●	● ●	● ●	● ○	● ○	● ○	○ -

**Table 60. Thermal Configuration Matrix with Dual 4<sup>th</sup> Gen Processors Installed Normal Operating Mode (Table 2 of 4) (M50FCP2UR x8 Drive with 1U Heat Sink)**

Intel® Server M50FCPR2UR208, 1U Heatsink, Air-cooled								
Max Ambient Temperature	15°C	20°C	25°C	27°C	32°C	35°C	40°C	45°C
<b>CPU SKU</b>	<b>CPU Support (TDP 205W)</b>							
Intel® Xeon® Gold 6438M, 205W, 32C	● ●	● ●	● ●	● ●	● ●	● ●	● ○	● ○
Intel® Xeon® Gold 6438N, 205W, 32C	● ●	● ●	● ●	● ●	● ●	● ●	● ○	● ○
Intel® Xeon® Gold 6438Y+, 205W, 32C	● ●	● ●	● ●	● ●	● ○	● ○	○ ○	○ ○
Intel® Xeon® Gold 5420+, 205W, 28C	● ●	● ●	● ●	● ●	● ●	● ●	● ○	● ○

Intel® Server System M50FCP2UR Technical Product Specification

Intel® Xeon® Gold 6434, 195W, 8C	●●	●○	●○	●○	○○	○○	-	-
Intel® Xeon® Gold 6434H, 195W, 8C	●●	●○	●○	●○	○○	○○	-	-
Intel® Xeon® Gold 6428N, 185W, 32C	●●	●●	●●	●●	●●	●●	●●	●○
Intel® Xeon® Gold 6421N, 185W, 32C	●●	●●	●●	●●	●●	●●	●●	●○
Intel® Xeon® Gold 5418Y, 185W, 24C	●●	●●	●●	●●	●●	●●	●○	●○
Intel® Xeon® Gold 6418H, 185W, 24C	●●	●●	●●	●●	●●	●●	●○	●○
Intel® Xeon® Gold 5412U, 185W, 24C	●●	●●	●●	●●	●●	●●	●○	●○
Intel® Xeon® Gold 6426Y, 185W, 16C	●●	●●	●●	●●	●●	●●	●○	●○
Intel® Xeon® Gold 5418N, 165W, 24C	●●	●●	●●	●●	●●	●●	●●	●○
Intel® Xeon® Gold 5411N, 165W, 24C	●●	●●	●●	●●	●●	●●	●●	●○
Intel® Xeon® Silver 4416+, 165W, 20C	●●	●●	●●	●●	●●	●●	●●	●○
Intel® Xeon® Gold 6416H, 165W, 18C	●●	●●	●●	●●	●●	●●	●●	●○
Intel® Xeon® Gold 5416S, 150W, 16C	●●	●●	●●	●●	●●	●●	●●	●○
Intel® Xeon® Silver 4410Y, 150W, 12C	●●	●●	●●	●●	●●	●●	●●	●○
Intel® Xeon® Gold 5415+, 150W, 8C	●●	●●	●●	●●	●●	●●	●●	●○
Intel® Xeon® Bronze 3408U, 125W, 8C	●●	●●	●●	●●	●●	●●	●●	●●
Intel® Xeon® Silver 4410T, 150W, 10C	●●	●●	●●	●●	●●	●●	●●	●●
<b>Memory Type</b>	<b>Memory Support</b>							
DDR5, DRx8, 1x, 1DPC	●●	●●	●●	●●	●●	●●	●●	●●
DDR5, DRx4, 1x, 1DPC	●●	●●	●●	●●	●●	●●	●○	●○
DDR5, QRx4, 1x, 1DPC	●●	●●	●●	●●	●○	●○	●○	●○
DDR5, DRx8, 1x, 2DPC	●●	●●	●●	●●	●●	●●	●●	●●
DDR5, DRx4, 1x, 2DPC	●●	●●	●●	●●	●●	●●	●●	●●
DDR5, QRx4, 1x, 2DPC	●●	●●	●●	●●	●●	●●	●●	●●
DDR5, DRx8, 2x, 1DPC	●●	●●	●●	●●	●●	●●	●●	●●
DDR5, DRx4, 2x, 1DPC	●●	●●	●●	●●	●●	●●	●●	●○

Intel® Server System M50FCP2UR Technical Product Specification

DDR5, QRx4, 2x, 1DPC	●●	●●	●●	●●	●●	●○	●○	●○
DDR5, DRx8, 2x, 2DPC	●●	●●	●●	●●	●●	●●	●●	●●
DDR5, DRx4, 2x, 2DPC	●●	●●	●●	●●	●●	●●	●●	●●
DDR5, QRx4, 2x, 2DPC	●●	●●	●●	●●	●●	●●	●●	●●
<b>PCI Card Cooling</b>	<b>Supported Thermal Level</b>							
Riser 1 slot 1	LEVEL7 / LEVEL7	LEVEL7 / LEVEL7	LEVEL7 / LEVEL7	LEVEL7 / LEVEL7	LEVEL7 / LEVEL7	LEVEL7 / LEVEL7	LEVEL6 / LEVEL6	LEVEL6 / LEVEL6
Riser 1 slot 2	LEVEL7 / LEVEL7	LEVEL7 / LEVEL7	LEVEL7 / LEVEL7	LEVEL7 / LEVEL7	LEVEL7 / LEVEL7	LEVEL7 / LEVEL7	LEVEL6 / LEVEL6	LEVEL5 / LEVEL6
Riser 1 slot 3	LEVEL7 / LEVEL7	LEVEL7 / LEVEL7	LEVEL7 / LEVEL7	LEVEL7 / LEVEL7	LEVEL7 / LEVEL7	LEVEL7 / LEVEL7	LEVEL6 / LEVEL6	LEVEL5 / LEVEL5
Riser 2 slot 1	LEVEL7 / LEVEL6	LEVEL7 / LEVEL6	LEVEL7 / LEVEL5	LEVEL7 / LEVEL5	LEVEL7 / LEVEL5	LEVEL7 / LEVEL5	LEVEL6 / LEVEL5	LEVEL6 / LEVEL4
Riser 2 slot 2	LEVEL7 / LEVEL7	LEVEL7 / LEVEL7	LEVEL7 / LEVEL7	LEVEL7 / LEVEL7	LEVEL7 / LEVEL7	LEVEL7 / LEVEL7	LEVEL6 / LEVEL6	LEVEL5 / LEVEL6
Riser 2 slot 3	LEVEL7 / LEVEL7	LEVEL7 / LEVEL7	LEVEL7 / LEVEL7	LEVEL7 / LEVEL7	LEVEL7 / LEVEL7	LEVEL7 / LEVEL7	LEVEL6 / LEVEL6	LEVEL5 / LEVEL5
Riser 3 slot 1	LEVEL7 / LEVEL7	LEVEL7 / LEVEL7	LEVEL7 / LEVEL7	LEVEL7 / LEVEL7	LEVEL7 / LEVEL7	LEVEL7 / LEVEL6	LEVEL6 / LEVEL6	LEVEL6 / LEVEL5
Riser 3 slot 2	LEVEL7 / LEVEL7	LEVEL7 / LEVEL7	LEVEL7 / LEVEL7	LEVEL7 / LEVEL7	LEVEL7 / LEVEL7	LEVEL7 / LEVEL6	LEVEL6 / LEVEL6	LEVEL6 / LEVEL5
<b>3.5" SAS/SATA SSD</b>	<b>3.5" SAS/SATA SSD Support</b>							
Rated to 60C	-	-	-	-	-	-	-	-
<b>2.5" PCIe NVMe SSD</b>	<b>2.5" PCIe NVMe SSD Support</b>							
NVMe TDP = 25W, Rated to 70C	●●	●●	●●	●●	●●	●●	○-	-
<b>GPGPU card type</b>	<b>GPGPU card Support</b>							
Nvidia DW GPGPU - A16/A30/A40/A100-40G/A100-80G/H100	●-	●-	●-	●-	●-	●-	-	-
Intel® FPGA PAC D5005 - DW - 225W	●-	●-	●-	●-	●-	●-	-	-
PonteVecchio - DW - 300W	●-	●-	●-	●-	●-	-	-	-



Intel® Server System M50FCP2UR Technical Product Specification

Intel ATS M1 - FH, 3/4 Length, Single Slot - 150W	● -	● -	● -	● -	● -	● -	-	-
Nvidia Tesla A2 - LP- 60W	● -	● -	● -	-	-	-	-	-
Intel ATS M3 - LP- 75W	● -	● -	● -	● -	● -	● -	-	-
<b>Rear SSD above PSUs</b>	<b>Rear SSD Support</b>							
SATA SSD, Rated to 70C	● ●	● ●	● ●	● ●	● ●	● ●	● ●	● ●
<b>M.2 SSD</b>	<b>M.2 NVMe SSD Support</b>							
Micron 7400/7450 series (rated to 70C, TDP = 8W)	● ●	● ●	● ●	● ●	● -	● -	-	-
Other NVMe/SATA SSD in APlist (rated to 70C)	● ●	● ●	● ●	● ●	● ●	● ●	● ○	● ○
<b>PSU</b>	<b>PSU Support (Fan normal: 205W / Fan fail : 185W)</b>							
2100W	● ●	● ●	● ●	● ●	● ●	● ●	● ●	● ●
1600W	● ●	● ●	● ●	● ●	● ●	● ●	● ●	● ●
1300W	● ●	● ●	● ●	● ●	● ●	● ●	● ●	● ●
<b>OCP V3</b>	<b>OCP V3 Support</b>							
OCP 25W w/ class-2 QSFP	● ●	● ●	● ●	● ●	● ●	● ●	● ○	● ○
<b>Battery Backup</b>	<b>Battery Backup Support</b>							
BBU inlet (rated to 45C)	● ●	● ●	● ●	● ●	● ●	● ●	● ○	○ -

**Table 61. Thermal Configuration Matrix with Dual 5<sup>th</sup> Gen Processors Installed Normal Operating Mode (Table 3 of 4) (M50FCP2UR x8 Drive with 2U Heat Sink)**

Intel® Server M50FCPR2UR208, 2U Heatsink, Air-cooled								
Max Ambient Temperature	15°C	20°C	25°C	27°C	32°C	35°C	40°C	45°C
<b>CPU SKU</b>	<b>CPU Support (TDP 350W)</b>							
Intel® Xeon® Platinum 8592+, 350W, 64C	● ●	● ●	● ●	● ●	● ●	● ●	● -	● -
Intel® Xeon® Platinum 8580, 350W, 60C	● ●	● ●	● ●	● ●	● ●	● ●	● -	● -

Intel® Server System M50FCP2UR Technical Product Specification

Intel® Xeon® Platinum 8570, 350W, 56C	●●	●●	●●	●●	●●	●●	●-	●-
Intel® Xeon® Platinum 8558P, 350W, 48C	●●	●●	●●	●●	●●	●●	●-	●-
Intel® Xeon® Platinum 8568Y+, 350W, 48C	●●	●●	●●	●●	●●	●●	●-	●-
Intel® Xeon® Platinum 8592V, 330W, 64C	●●	●●	●●	●●	●●	●●	●○	●-
Intel® Xeon® Platinum 8558, 330W, 48C	●●	●●	●●	●●	●●	●●	●○	●-
Intel® Xeon® Platinum 8571N, 300W, 52C	●●	●●	●●	●●	●●	●●	●●	●-
Intel® Xeon® Platinum 8558U, 300W, 48C	●●	●●	●●	●●	●●	●●	●●	●-
Intel® Xeon® Platinum 8581V, 270W, 60C	●●	●●	●●	●●	●●	●●	●●	●-
Intel® Xeon® Gold 6554S, 270W, 36C	●●	●●	●●	●●	●●	●●	●●	●-
Intel® Xeon® Gold 6530, 270W, 32C	●●	●●	●●	●●	●●	●●	●●	●-
Intel® Xeon® Platinum 8562Y+, 300W, 32C	●●	●●	●●	●●	●●	●●	●○	●-
Intel® Xeon® Gold 6544Y, 270W, 16C	●●	●●	●●	●●	●●	●●	●○	●-
Intel® Xeon® Gold 6548Y+, 250W, 32C	●●	●●	●●	●●	●●	●●	●●	●●
Intel® Xeon® Gold 6548N, 250W, 32C	●●	●●	●●	●●	●●	●●	●●	●●
Intel® Xeon® Gold 6542Y, 250W, 24C	●●	●●	●●	●●	●●	●●	●●	●●
Intel® Xeon® Gold 6538Y+, 225W, 32C	●●	●●	●●	●●	●●	●●	●●	●●
Intel® Xeon® Gold 6538N, 205W, 32C	●●	●●	●●	●●	●●	●●	●●	●●
Intel® Xeon® Gold 5520+, 205W, 28C	●●	●●	●●	●●	●●	●●	●●	●●
Intel® Xeon® Gold 6526Y, 195W,16C	●●	●●	●●	●●	●●	●●	●●	●●
Intel® Xeon® Gold 6534, 195W, 8C	●●	●●	●●	●●	●●	●●	●○	○○
Intel® Xeon® Gold 5512U, 185W, 28C	●●	●●	●●	●●	●●	●●	●●	●●
Intel® Xeon® Silver 4516Y+, 185W, 24C	●●	●●	●●	●●	●●	●●	●●	●●
Intel® Xeon® Gold 5515+, 165W, 8C	●●	●●	●●	●●	●●	●●	●●	●●
Intel® Xeon® Gold 4514Y, 150W, 16C	●●	●●	●●	●●	●●	●●	●●	●●
Intel® Xeon® Silver 4510,150W,12C	●●	●●	●●	●●	●●	●●	●●	●●
<b>Memory Type</b>	<b>Memory Support</b>							

Intel® Server System M50FCP2UR Technical Product Specification

DDR5, DRx8, 1x, 1DPC	••	••	••	••	••	••	••	••
DDR5, DRx4, 1x, 1DPC	••	••	••	••	••	•○	•○	•○
DDR5, QRx4, 1x, 1DPC	••	••	••	•○	•○	•○	•○	•○
DDR5, DRx8, 1x, 2DPC	••	••	••	••	••	••	••	••
DDR5, DRx4, 1x, 2DPC	••	••	••	••	••	••	••	••
DDR5, QRx4, 1x, 2DPC	••	••	••	••	••	••	••	••
DDR5, DRx8, 2x, 1DPC	••	••	••	••	••	••	••	••
DDR5, DRx4, 2x, 1DPC	••	••	••	••	••	••	••	•○
DDR5, QRx4, 2x, 1DPC	••	••	••	••	••	•○	•○	•○
DDR5, DRx8, 2x, 2DPC	••	••	••	••	••	••	••	••
DDR5, DRx4, 2x, 2DPC	••	••	••	••	••	••	••	••
DDR5, QRx4, 2x, 2DPC	••	••	••	••	••	••	••	••
<b>PCI Card Cooling</b>	<b>Supported Thermal Level</b>							
Riser 1 slot 1	LEVEL7 / LEVEL7	LEVEL7 / LEVEL7	LEVEL7 / LEVEL7	LEVEL7 / LEVEL7	LEVEL7 / LEVEL7	LEVEL7 / LEVEL7	LEVEL6 / LEVEL6	LEVEL6 / LEVEL6
Riser 1 slot 2	LEVEL7 / LEVEL7	LEVEL7 / LEVEL6	LEVEL7 / LEVEL6	LEVEL7 / LEVEL6	LEVEL7 / LEVEL6	LEVEL7 / LEVEL6	LEVEL6 / LEVEL5	LEVEL6 / LEVEL5
Riser 1 slot 3	LEVEL7 / LEVEL7	LEVEL7 / LEVEL7	LEVEL7 / LEVEL7	LEVEL7 / LEVEL7	LEVEL7 / LEVEL7	LEVEL6 / LEVEL6	LEVEL6 / LEVEL6	LEVEL5 / LEVEL5
Riser 2 slot 1	LEVEL7 / LEVEL6	LEVEL7 / LEVEL6	LEVEL7 / LEVEL6	LEVEL7 / LEVEL6	LEVEL7 / LEVEL6	LEVEL7 / LEVEL5	LEVEL6 / LEVEL5	LEVEL6 / LEVEL3
Riser 2 slot 2	LEVEL7 / LEVEL7	LEVEL7 / LEVEL7	LEVEL7 / LEVEL7	LEVEL7 / LEVEL7	LEVEL7 / LEVEL7	LEVEL6 / LEVEL6	LEVEL6 / LEVEL6	LEVEL5 / LEVEL5
Riser 2 slot 3	LEVEL7 / LEVEL7	LEVEL7 / LEVEL7	LEVEL7 / LEVEL7	LEVEL7 / LEVEL7	LEVEL7 / LEVEL7	LEVEL6 / LEVEL6	LEVEL6 / LEVEL6	LEVEL5 / LEVEL5
Riser 3 slot 1	LEVEL7 / LEVEL7	LEVEL7 / LEVEL7	LEVEL7 / LEVEL7	LEVEL7 / LEVEL7	LEVEL7 / LEVEL6	LEVEL7 / LEVEL6	LEVEL6 / LEVEL5	LEVEL6 / LEVEL4
Riser 3 slot 2	LEVEL7 / LEVEL7	LEVEL7 / LEVEL7	LEVEL7 / LEVEL7	LEVEL7 / LEVEL7	LEVEL7 / LEVEL6	LEVEL7 / LEVEL6	LEVEL6 / LEVEL5	LEVEL6 / LEVEL4
<b>3.5" SAS/SATA SSD</b>	<b>3.5" SAS/SATA SSD Support</b>							
Rated to 60C	-	-	-	-	-	-	-	-

<b>2.5" PCIe NVMe SSD</b>	<b>2.5" PCIe NVMe SSD Support</b>							
NVMe TDP = 25W, Rated to 70C	●●	●●	●●	●●	●●	●●	○-	-
<b>GPGPU card type</b>	<b>GPGPU card Support</b>							
Nvidia DW GPGPU - A16/A30/A40/A100-40G/A100-80G/H100	-	-	-	-	-	-	-	-
Intel® FPGA PAC D5005 - DW - 225W	-	-	-	-	-	-	-	-
PonteVecchio - DW - 300W	-	-	-	-	-	-	-	-
Intel ATS M1 - FH, 3/4 Length, Single Slot - 150W	-	-	-	-	-	-	-	-
Nvidia Tesla A2 - LP- 60W	●-	●-	●-	●-	-	-	-	-
Intel ATS M3 - LP- 75W	●-	●-	●-	●-	●-	●-	-	-
<b>Rear SSD above PSUs</b>	<b>Rear SSD Support</b>							
SATA SSD, Rated to 70C	●●	●●	●●	●●	●●	●●	●●	●●
<b>M.2 SSD</b>	<b>M.2 NVMe SSD Support</b>							
Micron 7400/7450 series (rated to 70C, TDP = 8W)	●●	●●	●●	●-	●-	●-	-	-
Other NVMe/SATA SSD in APlist (rated to 70C)	●●	●●	●●	●●	●●	●●	●○	●○
<b>PSU</b>	<b>PSU Support (Fan normal : 350W / Fan fail : 330W)</b>							
2100W	●●	●●	●●	●●	●●	●●	●●	●-
1600W	●●	●●	●●	●●	●●	●●	●●	●-
1300W	●●	●●	●●	●●	●●	●●	●●	●-
<b>OCP V3</b>	<b>OCP V3 Support</b>							
OCP 25W w/ class-2 QSFP	●●	●●	●●	●●	●●	●●	●○	-
<b>Battery Backup</b>	<b>Battery Backup Support</b>							
BBU inlet (rated to 45C)	●●	●●	●●	●●	●○	●○	●○	○-

**Table 62. Thermal Configuration Matrix with Dual 5<sup>th</sup> Gen Processors Installed Normal Operating Mode (Table 4 of 4) (M50FCP2UR x8 Drive with 1U Heat Sink)**

Intel® Server M50FCPR2UR208, 1U Heatsink, Air-cooled								
Max Ambient Temperature	15°C	20°C	25°C	27°C	32°C	35°C	40°C	45°C
<b>CPU SKU</b>	<b>CPU Support (TDP205W)</b>							
Intel® Xeon® Gold 6538N, 205W, 32C	●●	●●	●●	●●	●●	●●	●○	●○
Intel® Xeon® Gold 5520+, 205W, 28C	●●	●●	●●	●●	●●	●●	●○	●○
Intel® Xeon® Gold 6526Y, 195W, 16C	●●	●●	●●	●●	●●	●●	●○	●○
Intel® Xeon® Gold 6534, 195W, 8C	●●	●○	●○	●○	○○	○○	-	-
Intel® Xeon® Gold 5512U, 185W, 28C	●●	●●	●●	●●	●●	●●	●●	●○
Intel® Xeon® Silver 4516Y+, 185W, 24C	●●	●●	●●	●●	●●	●●	●○	●○
Intel® Xeon® Gold 5515+, 165W, 8C	●●	●●	●●	●●	●●	●●	●○	●○
Intel® Xeon® Gold 4514Y, 150W, 16C	●●	●●	●●	●●	●●	●●	●●	●○
Intel® Xeon® Silver 4510, 150W, 12C	●●	●●	●●	●●	●●	●●	●●	●○
<b>Memory Type</b>	<b>Memory Support</b>							
DDR5, DRx8, 1x, 1DPC	●●	●●	●●	●●	●●	●●	●●	●●
DDR5, DRx4, 1x, 1DPC	●●	●●	●●	●●	●●	●●	●○	●○
DDR5, QRx4, 1x, 1DPC	●●	●●	●●	●●	●○	●○	●○	●○
DDR5, DRx8, 1x, 2DPC	●●	●●	●●	●●	●●	●●	●●	●●
DDR5, DRx4, 1x, 2DPC	●●	●●	●●	●●	●●	●●	●●	●●
DDR5, QRx4, 1x, 2DPC	●●	●●	●●	●●	●●	●●	●●	●●
DDR5, DRx8, 2x, 1DPC	●●	●●	●●	●●	●●	●●	●●	●●
DDR5, DRx4, 2x, 1DPC	●●	●●	●●	●●	●●	●●	●●	●○
DDR5, QRx4, 2x, 1DPC	●●	●●	●●	●●	●●	●○	●○	●○
DDR5, DRx8, 2x, 2DPC	●●	●●	●●	●●	●●	●●	●●	●●
DDR5, DRx4, 2x, 2DPC	●●	●●	●●	●●	●●	●●	●●	●●

Intel® Server System M50FCP2UR Technical Product Specification

DDR5, QRx4, 2x, 2DPC	••	••	••	••	••	••	••	••
<b>PCI Card Cooling</b>	<b>Supported Thermal Level</b>							
Riser 1 slot 1	LEVEL7 / LEVEL7	LEVEL7 / LEVEL7	LEVEL7 / LEVEL7	LEVEL7 / LEVEL7	LEVEL7 / LEVEL7	LEVEL7 / LEVEL7	LEVEL6 / LEVEL6	LEVEL6 / LEVEL6
Riser 1 slot 2	LEVEL7 / LEVEL7	LEVEL7 / LEVEL7	LEVEL7 / LEVEL7	LEVEL7 / LEVEL7	LEVEL7 / LEVEL7	LEVEL7 / LEVEL7	LEVEL6 / LEVEL6	LEVEL5 / LEVEL6
Riser 1 slot 3	LEVEL7 / LEVEL7	LEVEL7 / LEVEL7	LEVEL7 / LEVEL7	LEVEL7 / LEVEL7	LEVEL7 / LEVEL7	LEVEL7 / LEVEL7	LEVEL6 / LEVEL6	LEVEL5 / LEVEL5
Riser 2 slot 1	LEVEL7 / LEVEL6	LEVEL7 / LEVEL6	LEVEL7 / LEVEL5	LEVEL7 / LEVEL5	LEVEL7 / LEVEL5	LEVEL7 / LEVEL5	LEVEL6 / LEVEL5	LEVEL6 / LEVEL4
Riser 2 slot 2	LEVEL7 / LEVEL7	LEVEL7 / LEVEL7	LEVEL7 / LEVEL7	LEVEL7 / LEVEL7	LEVEL7 / LEVEL7	LEVEL7 / LEVEL7	LEVEL6 / LEVEL6	LEVEL5 / LEVEL6
Riser 2 slot 3	LEVEL7 / LEVEL7	LEVEL7 / LEVEL7	LEVEL7 / LEVEL7	LEVEL7 / LEVEL7	LEVEL7 / LEVEL7	LEVEL7 / LEVEL7	LEVEL6 / LEVEL6	LEVEL5 / LEVEL5
Riser 3 slot 1	LEVEL7 / LEVEL7	LEVEL7 / LEVEL7	LEVEL7 / LEVEL7	LEVEL7 / LEVEL7	LEVEL7 / LEVEL7	LEVEL7 / LEVEL6	LEVEL6 / LEVEL6	LEVEL6 / LEVEL5
Riser 3 slot 2	LEVEL7 / LEVEL7	LEVEL7 / LEVEL7	LEVEL7 / LEVEL7	LEVEL7 / LEVEL7	LEVEL7 / LEVEL7	LEVEL7 / LEVEL6	LEVEL6 / LEVEL6	LEVEL6 / LEVEL5
<b>3.5" SAS/SATA SSD</b>	<b>3.5" SAS/SATA SSD Support</b>							
Rated to 60C	-	-	-	-	-	-	-	-
<b>2.5" PCIe NVMe SSD</b>	<b>2.5" PCIe NVMe SSD Support</b>							
NVMe TDP = 25W, Rated to 70C	••	••	••	••	••	••	○-	-
<b>GPGPU card type</b>	<b>GPGPU card Support</b>							
Nvidia DW GPGPU - A16/A30/A40/A100-40G/A100-80G/H100	•-	•-	•-	•-	•-	•-	-	-
Intel® FPGA PAC D5005 - DW - 225W	•-	•-	•-	•-	•-	•-	-	-
PonteVecchio - DW - 300W	•-	•-	•-	•-	•-	-	-	-
Intel ATS M1 - FH, 3/4 Length, Single Slot - 150W	•-	•-	•-	•-	•-	•-	-	-
Nvidia Tesla A2 - LP- 60W	•-	•-	•-	-	-	-	-	-
Intel ATS M3 - LP- 75W	•-	•-	•-	•-	•-	•-	-	-

Intel® Server System M50FCP2UR Technical Product Specification

Rear SSD above PSUs	Rear SSD Support							
SATA SSD, Rated to 70C	●●	●●	●●	●●	●●	●●	●●	●●
M.2 SSD	M.2 NVMe SSD Support							
Micron 7400/7450 series (rated to 70C, TDP = 8W)	●●	●●	●●	●●	●-	●-	-	-
Other NVMe/SATA SSD in APlist (rated to 70C)	●●	●●	●●	●●	●●	●●	●○	●○
PSU	PSU Support (Fan normal: 205W / Fan fail : 185W)							
2100W	●●	●●	●●	●●	●●	●●	●●	●●
1600W	●●	●●	●●	●●	●●	●●	●●	●●
1300W	●●	●●	●●	●●	●●	●●	●●	●●
OCP V3	OCP V3 Support							
OCP 25W w/ class-2 QSFP	●●	●●	●●	●●	●●	●●	●○	●○
Battery Backup	Battery Backup Support							
BBU inlet (rated to 45C)	●●	●●	●●	●●	●●	●●	●○	○-

**Table 63. Thermal Configuration Matrix with Dual 4<sup>th</sup> Gen Processors Installed Normal Operating Mode (Table 1 of 4) (M50FCP2UR312 with 2U Heat Sink)**

Intel® Server M50FCPR2UR2312, 2U Heatsink, Air-cooled								
Max Ambient Temperature	15°C	20°C	25°C	27°C	32°C	35°C	40°C	45°C
CPU SKU	CPU Support (TDP 250W)							
Intel® Xeon® Gold 6414U, 250W, 32C	●○	●-	●-	●-	●-	●-	○-	-
Intel® Xeon® Platinum 8450H, 250W, 28C	●○	●-	●-	●-	●-	●-	○-	-
Intel® Xeon® Gold 6448H, 250W, 32C	●○	●-	●-	●-	●-	●-	○-	-
Intel® Xeon® Gold 6448Y, 225W, 32C	●●	●○	●-	●-	●-	●-	○-	-
Intel® Xeon® Gold 6442Y, 225W, 24C	●●	●○	●-	●-	●-	●-	○-	-

Intel® Server System M50FCP2UR Technical Product Specification

Intel® Xeon® Gold 6438M, 205W, 32C	●●	●●	●●	●○	●-	●-	●-	●-
Intel® Xeon® Gold 6438N, 205W, 32C	●●	●●	●●	●○	●-	●-	●-	●-
Intel® Xeon® Gold 6438Y+, 205W, 32C	●●	●○	●○	●○	●-	●-	○-	-
Intel® Xeon® Gold 5420+, 205W, 28C	●●	●●	●○	●○	●-	●-	●-	●-
Intel® Xeon® Gold 6434, 195W, 8C	●○	●○	●○	●○	○-	○-	-	-
Intel® Xeon® Gold 6434H, 195W, 8C	●○	●○	●○	●○	○-	○-	-	-
Intel® Xeon® Gold 6428N, 185W, 32C	●●	●●	●●	●●	●-	●-	●-	●-
Intel® Xeon® Gold 6421N, 185W, 32C	●●	●●	●●	●●	●-	●-	●-	●-
Intel® Xeon® Gold 5418Y, 185W, 24C	●●	●●	●●	●○	●-	●-	●-	●-
Intel® Xeon® Gold 6418H, 185W, 24C	●●	●●	●●	●○	●-	●-	●-	●-
Intel® Xeon® Gold 5412U, 185W, 24C	●●	●●	●●	●○	●-	●-	●-	●-
Intel® Xeon® Gold 6426Y, 185W, 16C	●●	●●	●●	●○	●-	●-	●-	●-
Intel® Xeon® Gold 5418N, 165W, 24C	●●	●●	●●	●●	●●	●-	●-	●-
Intel® Xeon® Gold 5411N, 165W, 24C	●●	●●	●●	●●	●●	●-	●-	●-
Intel® Xeon® Silver 4416+, 165W, 20C	●●	●●	●●	●●	●●	●-	●-	●-
Intel® Xeon® Gold 6416H, 165W, 18C	●●	●●	●●	●●	●●	●-	●-	●-
Intel® Xeon® Gold 5416S, 150W, 16C	●●	●●	●●	●●	●●	●○	●-	●-
Intel® Xeon® Silver 4410Y, 150W, 12C	●●	●●	●●	●●	●●	●○	●-	●-
Intel® Xeon® Gold 5415+, 150W, 8C	●●	●●	●●	●●	●●	●○	●-	●-
Intel® Xeon® Bronze 3408U, 125W, 8C	●●	●●	●●	●●	●●	●●	●○	●-
Intel® Xeon® Silver 4410T, 150W, 10C	●●	●●	●●	●●	●●	●●	●-	●-
<b>Memory Type</b>	<b>Memory Support</b>							
DDR5, DRx8, 1x, 1DPC	●●	●●	●●	●●	●●	●●	●○	●○
DDR5, DRx4, 1x, 1DPC	●●	●●	●○	●○	○○	○○	-	-
DDR5, QRx4, 1x, 1DPC	●○	●○	○○	○○	-	-	-	-
DDR5, DRx8, 1x, 2DPC	●●	●●	●●	●●	●●	●●	●●	●●



Intel® Server System M50FCP2UR Technical Product Specification

DDR5, DRx4, 1x, 2DPC	●●	●●	●●	●●	●●	●●	●●	●○
DDR5, QRx4, 1x, 2DPC	●●	●●	●●	●●	●●	●○	●○	○○
DDR5, DRx8, 2x, 1DPC	●●	●●	●●	●●	●●	●●	●●	●●
DDR5, DRx4, 2x, 1DPC	●●	●●	●●	●●	●○	●○	○○	○○
DDR5, QRx4, 2x, 1DPC	●●	●○	●○	●○	○○	○○	-	-
DDR5, DRx8, 2x, 2DPC	●●	●●	●●	●●	●●	●●	●●	●●
DDR5, DRx4, 2x, 2DPC	●●	●●	●●	●●	●●	●●	●●	●●
DDR5, QRx4, 2x, 2DPC	●●	●●	●●	●●	●●	●●	●●	●○
<b>PCI Card Cooling</b>	<b>Supported Thermal Level</b>							
Riser 1 slot 1	LEVEL6 / LEVEL6	LEVEL6 / LEVEL6	LEVEL5 / LEVEL5	LEVEL5 / LEVEL5	LEVEL5 / LEVEL5	LEVEL5 / LEVEL4	LEVEL5 / LEVEL4	LEVEL3 / LEVEL3
Riser 1 slot 2	LEVEL7 / LEVEL6	LEVEL6 / LEVEL6	LEVEL6 / LEVEL6	LEVEL6 / LEVEL6	LEVEL6 / LEVEL5	LEVEL6 / LEVEL5	LEVEL4 / LEVEL5	LEVEL3 / LEVEL4
Riser 1 slot 3	LEVEL7 / LEVEL7	LEVEL7 / LEVEL7	LEVEL7 / LEVEL7	LEVEL7 / LEVEL7	LEVEL6 / LEVEL6	LEVEL6 / LEVEL6	LEVEL5 / LEVEL6	LEVEL4 / LEVEL5
Riser 2 slot 1	LEVEL6 / LEVEL6	LEVEL5 / LEVEL5	LEVEL5 / LEVEL5	LEVEL5 / LEVEL5	LEVEL5 / LEVEL5	LEVEL5 / LEVEL5	LEVEL3 / LEVEL3	LEVEL2 / LEVEL2
Riser 2 slot 2	LEVEL6 / LEVEL7	LEVEL6 / LEVEL7	LEVEL6 / LEVEL7	LEVEL6 / LEVEL7	LEVEL5 / LEVEL6	LEVEL5 / LEVEL6	LEVEL4 / LEVEL5	LEVEL3 / LEVEL3
Riser 2 slot 3	LEVEL7 / LEVEL7	LEVEL7 / LEVEL6	LEVEL7 / LEVEL6	LEVEL6 / LEVEL6	LEVEL6 / LEVEL6	LEVEL6 / LEVEL6	LEVEL5 / LEVEL4	LEVEL4 / LEVEL3
Riser 3 slot 1	LEVEL7 / LEVEL6	LEVEL7 / LEVEL6	LEVEL7 / LEVEL5	LEVEL7 / LEVEL5	LEVEL6 / LEVEL5	LEVEL6 / LEVEL3	LEVEL6 / LEVEL3	LEVEL5 / LEVEL2
Riser 3 slot 2	LEVEL7 / LEVEL6	LEVEL7 / LEVEL6	LEVEL7 / LEVEL5	LEVEL6 / LEVEL5	LEVEL6 / LEVEL5	LEVEL6 / LEVEL4	LEVEL5 / LEVEL3	LEVEL4 / LEVEL2
<b>3.5" SAS/SATA SSD</b>	<b>3.5" SAS/SATA SSD Support</b>							
Rated to 60C	●●	●●	●●	●●	●●	●●	●○	●○
<b>2.5" PCIe NVMe SSD</b>	<b>2.5" PCIe NVMe SSD Support</b>							
NVMe TDP = 25W, Rated to 70C	●●	●●	●●	●●	●●	●●	●●	●○
<b>GPGPU card type</b>	<b>GPGPU card Support</b>							

Intel® Server System M50FCP2UR Technical Product Specification

Nvidia DW GPGPU - A16/A30/A40/A100-40G/A100-80G/H100	-	-	-	-	-	-	-	-
Intel® FPGA PAC D5005 - DW - 225W	-	-	-	-	-	-	-	-
PonteVecchio - DW - 300W	-	-	-	-	-	-	-	-
Intel ATS M1 - FH, 3/4 Length, Single Slot - 150W	-	-	-	-	-	-	-	-
Nvidia Tesla A2 - LP- 60W	-	-	-	-	-	-	-	-
Intel ATS M3 - LP- 75W	-	-	-	-	-	-	-	-
<b>Rear SSD above PSUs</b>	<b>Rear SSD Support</b>							
SATA SSD, Rated to 70C	●●	●●	●●	●●	●●	●●	●●	○-
<b>M.2 SSD</b>	<b>M.2 NVMe SSD Support</b>							
Micron 7400/7450 series (rated to 70C, TDP = 8W)	●●	●●	●-	-	-	-	-	-
Other NVMe/SATA SSD in APlist (rated to 70C)	●●	●●	●●	●●	●●	●○	●○	○-
<b>PSU</b>	<b>PSU Support (Fan normal: 250W / Fan fail : 125W)</b>							
2100W	●●	●●	●●	●●	●●	●●	●●	-
1600W	●●	●●	●●	●●	●●	●●	●●	-
1300W	●●	●●	●●	●●	●●	●●	●●	-
<b>OCP V3</b>	<b>OCP V3 Support</b>							
OCP 25W w/ class-2 QSFP	●●	●●	●●	●●	●●	●●	●○	-
<b>Battery Backup</b>	<b>Battery Backup Support</b>							
BBU inlet (rated to 45C)	●●	●●	●●	●○	●○	●○	○-	-

**Table 64. Thermal Configuration Matrix with Dual 4<sup>th</sup> Gen Processors Installed – Normal Operating Mode (Table 2 of 4) (M50FCP2UR312 with 1U Heat Sink)**

Intel® Server M50FCP2UR2312, 1U Heatsink, Air-cooled								
Max Ambient Temperature	15°C	20°C	25°C	27°C	32°C	35°C	40°C	45°C
<b>CPU SKU</b>	<b>CPU Support (TDP 185W)</b>							
Intel® Xeon® Gold 6428N, 185W, 32C	●●	●●	●○	●○	●-	●-	○-	-
Intel® Xeon® Gold 6421N, 185W, 32C	●●	●●	●○	●○	●-	●-	○-	-
Intel® Xeon® Gold 5418Y, 185W, 24C	●●	●○	●○	●○	●-	○-	-	-
Intel® Xeon® Gold 6418H, 185W, 24C	●●	●○	●○	●○	●-	○-	-	-
Intel® Xeon® Gold 5412U, 185W, 24C	●●	●○	●○	●○	●-	○-	-	-
Intel® Xeon® Gold 6426Y, 185W, 16C	●●	●○	●○	●○	●-	○-	-	-
Intel® Xeon® Gold 5418N, 165W, 24C	●●	●●	●●	●○	●○	●-	●-	-
Intel® Xeon® Gold 5411N, 165W, 24C	●●	●●	●●	●○	●○	●-	●-	-
Intel® Xeon® Silver 4416+, 165W, 20C	●●	●●	●○	●○	●○	●-	○-	-
Intel® Xeon® Gold 6416H, 165W, 18C	●●	●●	●○	●○	●○	●-	○-	-
Intel® Xeon® Gold 5416S, 150W, 16C	●●	●●	●●	●○	●○	●○	●-	○-
Intel® Xeon® Silver 4410Y, 150W, 12C	●●	●●	●●	●○	●○	●○	○-	-
Intel® Xeon® Gold 5415+, 150W, 8C	●●	●●	●●	●○	●○	●○	○-	-
Intel® Xeon® Bronze 3408U, 125W, 8C	●●	●●	●●	●●	●●	●○	●-	○-
Intel® Xeon® Silver 4410T, 150W, 10C	●●	●●	●●	●●	●○	●○	●-	●-
<b>Memory Type</b>	<b>Memory Support</b>							
DDR5, DRx8, 1x, 1DPC	●●	●●	●●	●●	●●	●●	●○	●○
DDR5, DRx4, 1x, 1DPC	●●	●○	●○	●○	●○	○○	○○	-
DDR5, QRx4, 1x, 1DPC	●○	●○	●○	●○	○○	-	-	-
DDR5, DRx8, 1x, 2DPC	●●	●●	●●	●●	●●	●●	●●	●●
DDR5, DRx4, 1x, 2DPC	●●	●●	●●	●●	●●	●●	●○	●○

Intel® Server System M50FCP2UR Technical Product Specification

DDR5, QRx4, 1x, 2DPC	●●	●●	●●	●●	●○	●○	●○	●-
DDR5, DRx8, 2x, 1DPC	●●	●●	●●	●●	●●	●●	●●	●○
DDR5, DRx4, 2x, 1DPC	●●	●●	●○	●○	●○	●○	●○	○○
DDR5, QRx4, 2x, 1DPC	●○	●○	●○	●○	●○	○○	○○	-
DDR5, DRx8, 2x, 2DPC	●●	●●	●●	●●	●●	●●	●●	●●
DDR5, DRx4, 2x, 2DPC	●●	●●	●●	●●	●●	●●	●●	●●
DDR5, QRx4, 2x, 2DPC	●●	●●	●●	●●	●●	●●	●○	●○
<b>PCI Card Cooling</b>	<b>Supported Thermal Level</b>							
Riser 1 slot 1	LEVEL5 / LEVEL6	LEVEL5 / LEVEL6	LEVEL5 / LEVEL5	LEVEL5 / LEVEL5	LEVEL5 / LEVEL5	LEVEL4 / LEVEL5	LEVEL4 / LEVEL5	LEVEL2 / LEVEL3
Riser 1 slot 2	LEVEL7 / LEVEL6	LEVEL7 / LEVEL6	LEVEL6 / LEVEL6	LEVEL6 / LEVEL6	LEVEL6 / LEVEL5	LEVEL5 / LEVEL5	LEVEL4 / LEVEL3	LEVEL4 / LEVEL3
Riser 1 slot 3	LEVEL7 / LEVEL7	LEVEL7 / LEVEL7	LEVEL7 / LEVEL6	LEVEL6 / LEVEL6	LEVEL6 / LEVEL6	LEVEL6 / LEVEL5	LEVEL5 / LEVEL4	LEVEL4 / LEVEL3
Riser 2 slot 1	LEVEL6 / LEVEL5	LEVEL6 / LEVEL5	LEVEL6 / LEVEL5	LEVEL6 / LEVEL5	LEVEL6 / LEVEL4	LEVEL4 / LEVEL4	LEVEL3 / LEVEL2	LEVEL3 / LEVEL2
Riser 2 slot 2	LEVEL7 / LEVEL7	LEVEL7 / LEVEL7	LEVEL6 / LEVEL7	LEVEL6 / LEVEL7	LEVEL6 / LEVEL6	LEVEL5 / LEVEL6	LEVEL4 / LEVEL5	LEVEL4 / LEVEL4
Riser 2 slot 3	LEVEL7 / LEVEL7	LEVEL7 / LEVEL7	LEVEL7 / LEVEL6	LEVEL7 / LEVEL6	LEVEL6 / LEVEL6	LEVEL6 / LEVEL6	LEVEL5 / LEVEL6	LEVEL4 / LEVEL4
Riser 3 slot 1	LEVEL7 / LEVEL6	LEVEL7 / LEVEL6	LEVEL7 / LEVEL5	LEVEL7 / LEVEL5	LEVEL7 / LEVEL3	LEVEL6 / LEVEL3	LEVEL6 / LEVEL3	LEVEL5 / LEVEL2
Riser 3 slot 2	LEVEL7 / LEVEL6	LEVEL7 / LEVEL5	LEVEL7 / LEVEL5	LEVEL6 / LEVEL5	LEVEL6 / LEVEL3	LEVEL6 / LEVEL3	LEVEL5 / LEVEL2	LEVEL4 / LEVEL2
<b>3.5" SAS/SATA SSD</b>	<b>3.5" SAS/SATA SSD Support</b>							
Rated to 60C	●●	●●	●●	●●	●●	●●	●○	●○
<b>2.5" PCIe NVMe SSD</b>	<b>2.5" PCIe NVMe SSD Support</b>							
NVMe TDP = 25W, Rated to 70C	●●	●●	●●	●●	●●	●●	●●	●○
<b>GPGPU card type</b>	<b>GPGPU card Support</b>							
Nvidia DW GPGPU - A16/A30/A40/A100-40G/A100-80G/H100	-	-	-	-	-	-	-	-

Intel® Server System M50FCP2UR Technical Product Specification

Intel® FPGA PAC D5005 - DW - 225W	-	-	-	-	-	-	-	-
PonteVecchio - DW - 300W	-	-	-	-	-	-	-	-
Intel ATS M1 - FH, 3/4 Length, Single Slot - 150W	-	-	-	-	-	-	-	-
Nvidia Tesla A2 - LP- 60W	-	-	-	-	-	-	-	-
Intel ATS M3 - LP- 75W	-	-	-	-	-	-	-	-
<b>Rear SSD above PSUs</b>	<b>Rear SSD Support</b>							
SATA SSD, Rated to 70C	●●	●●	●●	●●	●●	●●	●●	○-
<b>M.2 SSD</b>	<b>M.2 NVMe SSD Support</b>							
Micron 7400/7450 series (rated to 70C, TDP = 8W)	●●	●●	●○	-	-	-	-	-
Other NVMe/SATA SSD in APlist (rated to 70C)	●●	●●	●●	●●	●●	●○	●○	○-
<b>PSU</b>	<b>PSU Support (Fan normal: 185W / Fan fail : 125W)</b>							
2100W	●●	●●	●●	●●	●●	●●	●○	-
1600W	●●	●●	●●	●●	●●	●●	●○	-
1300W	●●	●●	●●	●●	●●	●●	●○	-
<b>OCP V3</b>	<b>OCP V3 Support</b>							
OCP 25W w/ class-2 QSFP	●●	●●	●●	●●	●●	●●	●○	-
<b>Battery Backup</b>	<b>Battery Backup Support</b>							
BBU inlet (rated to 45C)		●●	●●	●○	●○	●○	○-	-

**Table 65. Thermal Configuration Matrix with Dual 5<sup>th</sup> Gen Processors Installed Normal Operating Mode (Table 3 of 4) (M50FCP2UR312 with 2U Heat Sink)**

Intel® Server M50FCPR2UR2312, 2U Heatsink, Air-cooled								
Max Ambient Temperature	15°C	20°C	25°C	27°C	32°C	35°C	40°C	45°C
<b>CPU SKU</b>	<b>CPU Support (TDP 250W)</b>							
Intel® Xeon® Gold 6548Y+, 250W, 32C	●○	●-	●-	●-	●-	●-	○-	-
Intel® Xeon® Gold 6548N, 250W, 32C	●○	●-	●-	●-	●-	●-	○-	-
Intel® Xeon® Gold 6542Y, 250W, 24C	●○	●-	●-	●-	●-	●-	○-	-
Intel® Xeon® Gold 6538Y+, 225W, 32C	●○	●○	●-	●-	●-	●-	○-	-
Intel® Xeon® Gold 6538N, 205W, 32C	●●	●●	●●	●○	●-	●-	●-	●-
Intel® Xeon® Gold 5520+, 205W, 28C	●●	●●	●●	●○	●-	●-	●-	●-
Intel® Xeon® Gold 6526Y, 195W, 16C	●●	●●	●●	●○	●-	●-	●-	●-
Intel® Xeon® Gold 6534, 195W, 8C	●○	●○	●○	●○	○-	-	-	-
Intel® Xeon® Gold 5512U, 185W, 28C	●●	●●	●●	●●	●-	●-	●-	●-
Intel® Xeon® Gold 5515+, 165W, 8C	●●	●●	●●	●●	●○	●-	●-	●-
Intel® Xeon® Silver 4516Y+, 185W, 24C	●●	●●	●●	●○	●-	●-	●-	●-
Intel® Xeon® Gold 4514Y, 150W, 16C	●●	●●	●●	●●	●●	●○	●-	●-
Intel® Xeon® Silver 4510, 150W, 12C	●●	●●	●●	●●	●●	●○	●-	●-
<b>Memory Type</b>	<b>Memory Support</b>							
DDR5, DRx8, 1x, 1DPC	●●	●●	●●	●●	●●	●●	●○	●○
DDR5, DRx4, 1x, 1DPC	●●	●●	●○	●○	○○	○○	-	-
DDR5, QRx4, 1x, 1DPC	●○	●○	○○	○○	-	-	-	-
DDR5, DRx8, 1x, 2DPC	●●	●●	●●	●●	●●	●●	●●	●●
DDR5, DRx4, 1x, 2DPC	●●	●●	●●	●●	●●	●●	●●	●○
DDR5, QRx4, 1x, 2DPC	●●	●●	●●	●●	●●	●○	●○	○○-
DDR5, DRx8, 2x, 1DPC	●●	●●	●●	●●	●●	●●	●●	-●●

Intel® Server System M50FCP2UR Technical Product Specification

DDR5, DRx4, 2x, 1DPC	●●	●●	●●	●●	●○	●○	○○	○○
DDR5, QRx4, 2x, 1DPC	●●	●○	●○	●○	○○	○○	-	-
DDR5, DRx8, 2x, 2DPC	●●	●●	●●	●●	●●	●●	●●	●●
DDR5, DRx4, 2x, 2DPC	●●	●●	●●	●●	●●	●●	●●	●●
DDR5, QRx4, 2x, 2DPC	●●	●●	●●	●●	●●	●●	●●	●○
<b>PCI Card Cooling</b>	<b>Supported Thermal Level</b>							
Riser 1 slot 1	LEVEL6 / LEVEL6	LEVEL6/ LEVEL6	LEVEL5/ LEVEL5	LEVEL5/ LEVEL5	LEVEL5/ LEVEL5	LEVEL5/ LEVEL4	LEVEL5/ LEVEL4	LEVEL3/ LEVEL3
Riser 1 slot 2	LEVEL7/ LEVEL6	LEVEL6/ LEVEL6	LEVEL6/ LEVEL6	LEVEL6/ LEVEL6	LEVEL6/ LEVEL5	LEVEL6/ EVEL5	LEVEL4/ LEVEL5	LEVEL3/ LEVEL4
Riser 1 slot 3	LEVEL7 / LEVEL7	LEVEL7/ LEVEL7	LEVEL7/ LEVEL7	LEVEL7/ LEVEL7	LEVEL6/ LEVEL6	LEVEL6/ LEVEL6	LEVEL5/ LEVEL6	LEVEL4/ LEVEL5
Riser 2 slot 1	LEVEL6 / LEVEL6	LEVEL5/ LEVEL5	LEVEL5/ LEVEL5	LEVEL5/ LEVEL5	LEVEL5/ LEVEL5	LEVEL5/ LEVEL5	LEVEL3 LEVEL3	LEVEL2/ LEVEL2
Riser 2 slot 2	LEVEL6 / LEVEL7	LEVEL6 / LEVEL7	LEVEL6 / LEVEL7	LEVEL6 / LEVEL7	LEVEL5/ LEVEL6	LEVEL5/ LEVEL6	LEVEL4 LEVEL5	LEVEL3/ LEVEL3
Riser 2 slot 3	LEVEL7/ LEVEL7	LEVEL7/ LEVEL6	LEVEL7/ LEVEL6	LEVEL6/ LEVEL6	LEVEL6/ LEVEL6	LEVEL6/ LEVEL6	LEVEL5/ LEVEL4	LEVEL4/ LEVEL3
Riser 3 slot 1	LEVEL7/ LEVEL6	LEVEL7/ LEVEL6	LEVEL7/ LEVEL6	LEVEL7/ LEVEL5	LEVEL6/ LEVEL5	LEVEL6 / LEVEL3	LEVEL6 / LEVEL3	LEVEL5/ LEVEL2
Riser 3 slot 2	LEVEL7/ LEVEL6	LEVEL7/ LEVEL6	LEVEL7/ LEVEL5	LEVEL6/ LEVEL5	LEVEL6/ LEVEL5	LEVEL6/ LEVEL4	LEVEL5/ LEVEL3	LEVEL4/ LEVEL2
<b>3.5" SAS/SATA SSD</b>	<b>3.5" SAS/SATA SSD Support</b>							
Rated to 60C	●●	●●	●●	●●	●●	●●	●○	●○
<b>2.5" PCIe NVMe SSD</b>	<b>2.5" PCIe NVMe SSD Support</b>							
NVMe TDP = 25W, Rated to 70C	●●	●●	●●	●●	●●	●●	●-	●○
<b>GPGPU card type</b>	<b>GPGPU card Support</b>							
Nvidia DW GPGPU - A16/A30/A40/A100-40G/A100-80G/H100	-	-	-	-	-	-	-	-
Intel® FPGA PAC D5005 - DW - 225W	-	-	-	-	-	-	-	-
PonteVecchio - DW - 300W	-	-	-	-	-	-	-	-

Intel® Server System M50FCP2UR Technical Product Specification

Intel ATS M1 - FH, 3/4 Length, Single Slot - 150W	-	-	-	-	-	-	-	-
Nvidia Tesla A2 - LP- 60W	-	-	-	-	-	-	-	-
Intel ATS M3 - LP- 75W	-	-	-	-	-	-	-	-
<b>Rear SSD above PSUs</b>	<b>Rear SSD Support</b>							
SATA SSD, Rated to 70C	●●	●●	●●	●●	●●	●●	●●	○-
<b>M.2 SSD</b>	<b>M.2 NVMe SSD Support</b>							
Micron 7400/7450 series (rated to 70C, TDP = 8W)	●●	●●	●-	-	-	-	-	-
Other NVMe/SATA SSD in APlist (rated to 70C)	●●	●●	●●	●●	●●	●○	●○	○-
<b>PSU</b>	<b>PSU Support (FAN normal:250W/ FAN fail:125W)</b>							
2100W	●●	●●	●●	●●	●●	●●	●●	-
1600W	●●	●●	●●	●●	●●	●●	●●	-
1300W	●●	●●	●●	●●	●●	●●	●●	-
<b>OCP V3</b>	<b>OCP V3 Support</b>							
OCP 25W w/ class-2 QSFP	●●	●●	●●	●●	●●	●●	●○	-
<b>Battery Backup</b>	<b>Battery Backup Support</b>							
BBU inlet (rated to 45C)	●●	●●	●●	●○	●○	●○	○-	-

**Table 66. Thermal Configuration Matrix with Dual 5<sup>th</sup> Gen Processors Installed Normal Operating Mode (Table 4 of 4) (M50FCP2UR312 with 1U Heat Sink)**

Intel® Server M50FCPR2UR2312, 1U Heatsink, Air-cooled								
Max Ambient Temperature	15°C	20°C	25°C	27°C	32°C	35°C	40°C	45°C
<b>CPU SKU</b>	<b>CPU Support (TDP 185W)</b>							
Intel® Xeon® Gold 5512U, 185W, 28C	●●	●●	●○	●○	●-	●-	●-	-
Intel® Xeon® Gold 5515+, 165W, 8C	●●	●○	●○	●○	●○	○-	-	-



Intel® Server System M50FCP2UR Technical Product Specification

Intel® Xeon® Silver 4516Y+, 185W, 24C	●●	●○	●○	●○	●-	○-	-	-
Intel® Xeon® Gold 4514Y, 150W, 16C	●●	●●	●●	●○	●○	●○	○-	-
Intel® Xeon® Silver 4510,150W,12C	●●	●●	●●	●○	●○	●○	○-	-
<b>Memory Type</b>	<b>Memory Support</b>							
DDR5, DRx8, 1x, 1DPC	●●	●●	●●	●●	●●	●●	●○	●○
DDR5, DRx4, 1x, 1DPC	●●	●○	●○	●○	●-	○○	○○	-
DDR5, QRx4, 1x, 1DPC	●○	●○	●○	○○	○○	-	-	-
DDR5, DRx8, 1x, 2DPC	●●	●●	●●	●●	●●	●●	●●	●●
DDR5, DRx4, 1x, 2DPC	●●	●●	●●	●●	●●	●●	●○	●○
DDR5, QRx4, 1x, 2DPC	●●	●●	●●	●●	●○	●○	●○	○○-
DDR5, DRx8, 2x, 1DPC	●●	●●	●●	●●	●●	●●	●●	●○
DDR5, DRx4, 2x, 1DPC	●●	●●	●○	●○	●○	●○	●○	○○
DDR5, QRx4, 2x, 1DPC	●○	●○	●○	●○	●○	○○	○○	-
DDR5, DRx8, 2x, 2DPC	●●	●●	●●	●●	●●	●●	●●	●●
DDR5, DRx4, 2x, 2DPC	●●	●●	●●	●●	●●	●●	●●	●●
DDR5, QRx4, 2x, 2DPC	●●	●●	●●	●●	●●	●●	●○	●○
<b>PCI Card Cooling</b>	<b>Supported Thermal Level</b>							
Riser 1 slot 1	LEVEL5 / LEVEL6	LEVEL5/ LEVEL6	LEVEL5/ LEVEL5	LEVEL5/ LEVEL5	LEVEL5/ LEVEL5	LEVEL4/ LEVEL5	LEVEL4/ LEVEL5	LEVEL2/ LEVEL3
Riser 1 slot 2	LEVEL7/ LEVEL6	LEVEL7/ LEVEL6	LEVEL6/ LEVEL6	LEVEL6/ LEVEL6	LEVEL6/ LEVEL5	LEVEL5/ LEVEL5	LEVEL4/ LEVEL3	LEVEL4/ LEVEL3
Riser 1 slot 3	LEVEL7/ LEVEL7	LEVEL7/ LEVEL7	LEVEL7/ LEVEL6	LEVEL6/ LEVEL6	LEVEL6/ LEVEL6	LEVEL6/ LEVEL5	LEVEL5/ LEVEL4	LEVEL4/ LEVEL3
Riser 2 slot 1	LEVEL6 / LEVEL5	LEVEL6/ LEVEL5	LEVEL6/ LEVEL5	LEVEL6/ LEVEL5	LEVEL6/ LEVEL4	LEVEL4/ LEVEL4	LEVEL3 LEVEL2	LEVEL3/ LEVEL2
Riser 2 slot 2	LEVEL7 / LEVEL7	LEVEL7 / LEVEL7	LEVEL6 / LEVEL7	LEVEL6 / LEVEL7	LEVEL6/ LEVEL6	LEVEL5/ LEVEL6	LEVEL4 LEVEL5	LEVEL4/ LEVEL4
Riser 2 slot 3	LEVEL7/ LEVEL7	LEVEL7/ LEVEL7	LEVEL7/ LEVEL6	LEVEL7/ LEVEL6	LEVEL6/ LEVEL6	LEVEL6/ LEVEL6	LEVEL5/ LEVEL6	LEVEL4/ LEVEL4

Intel® Server System M50FCP2UR Technical Product Specification

Riser 3 slot 1	LEVEL7/ LEVEL6	LEVEL7/ LEVEL6	LEVEL7/ LEVEL5	LEVEL7/ LEVEL5	LEVEL7/ LEVEL3	LEVEL6 / LEVEL3	LEVEL6 / LEVEL3	LEVEL5/ LEVEL2
Riser 3 slot 2	LEVEL7/ LEVEL6	LEVEL7/ LEVEL5	LEVEL7/ LEVEL5	LEVEL6/ LEVEL5	LEVEL6/ LEVEL3	LEVEL6/ LEVEL3	LEVEL5/ LEVEL2	LEVEL4/ LEVEL2
<b>3.5" SAS/SATA SSD</b>	<b>3.5" SAS/SATA SSD Support</b>							
Rated to 60C	●●	●●	●●	●●	●●	●●	●○	●○
<b>2.5" PCIe NVMe SSD</b>	<b>2.5" PCIe NVMe SSD Support</b>							
NVMe TDP = 25W, Rated to 70C	●●	●●	●●	●●	●●	●●	●●	●○
<b>GPGPU card type</b>	<b>GPGPU card Support</b>							
Nvidia DW GPGPU - A16/A30/A40/A100-40G/A100-80G/H100	-	-	-	-	-	-	-	-
Intel® FPGA PAC D5005 - DW - 225W	-	-	-	-	-	-	-	-
PonteVecchio - DW - 300W	-	-	-	-	-	-	-	-
Intel ATS M1 - FH, 3/4 Length, Single Slot - 150W	-	-	-	-	-	-	-	-
Nvidia Tesla A2 - LP- 60W	-	-	-	-	-	-	-	-
Intel ATS M3 - LP- 75W	-	-	-	-	-	-	-	-
<b>Rear SSD above PSUs</b>	<b>Rear SSD Support</b>							
SATA SSD, Rated to 70C	●●	●●	●●	●●	●●	●●	●●	○-
<b>M.2 SSD</b>	<b>M.2 NVMe SSD Support</b>							
Micron 7400/7450 series (rated to 70C, TDP = 8W)	●●	●●	●-	-	-	-	-	-
Other NVMe/SATA SSD in APlist (rated to 70C)	●●	●●	●●	●●	●●	●○	●○	○-
<b>PSU</b>	<b>PSU Support (FAN normal:250W/ FAN fail:125W))</b>							
2100W	●●	●●	●●	●●	●●	●●	●○	-
1600W	●●	●●	●●	●●	●●	●●	●○	-
1300W	●●	●●	●●	●●	●●	●●	●○	-

OCP V3	OCP V3 Support							
OCP 25W w/ class-2 QSFP	●●	●●	●●	●●	●●	●●	●○	-
Battery Backup	Battery Backup Support							
BBU inlet (rated to 45C)	●●	●●	●●	●○	●○	●○	○-	-

## C.2 Normal Operating Mode with Single Processor Installed

**Table 67. Thermal Configuration Matrix with Single 4<sup>th</sup> Gen Processors Installed Normal Operating Mode (Table 1 of 4) (M50FCP2UR208 x24 Drive with 2U Heat Sink)**

Intel® Server M50FCPR2UR224, 2U Heatsink , 1 Socket , Air-cooled								
Max Ambient Temperature	15°C	20°C	25°C	27°C	32°C	35°C	40°C	45°C
CPU SKU	CPU Support (TDP 300W)							
Intel® Xeon® Platinum 8471N, 300W, 52C	●-	●-	●-	●-	●-	●-	○-	-
Intel® Xeon® Platinum 8470N, 300W, 52C	●-	●-	●-	●-	●-	●-	○-	-
Intel® Xeon® Platinum 8461V, 300W, 48C	●-	●-	●-	●-	●-	●-	○-	-
Intel® Xeon® Platinum 8460Y+, 300W, 40C	●-	●-	●-	●-	●-	●-	○-	-
Intel® Xeon® Platinum 8452Y, 300W, 36C	●-	●-	●-	●-	●-	●-	○-	-
Intel® Xeon® Gold 6454S, 270W, 32C	●-	●-	●-	●-	●-	●-	○-	-
Intel® Xeon® Platinum 8454H, 270W, 32C	●-	●-	●-	●-	●-	●-	○-	-
Intel® Xeon® Gold 6430, 270W, 32C	●-	●-	●-	●-	●-	●-	○-	-
Intel® Xeon® Platinum 8444H, 270W, 16C	●-	●-	●-	●-	●-	●-	○-	-
Intel® Xeon® Gold 6414U, 250W, 32C	●-	●-	●-	●-	●-	●-	●-	○-
Intel® Xeon® Platinum 8450H, 250W, 28C	●-	●-	●-	●-	●-	●-	●-	○-
Intel® Xeon® Gold 6458Q, 350W, 32C	-	-	-	-	-	-	-	-
Intel® Xeon® Platinum 8462Y+, 300W, 32C	●-	●-	●-	●-	●-	○-	-	-
Intel® Xeon® Gold 6444Y, 270W, 16C	●-	●-	●-	●-	●-	○-	-	-
Intel® Xeon® Gold 6448H, 250W, 32C	●-	●-	●-	●-	●-	●-	●-	○-

Intel® Server System M50FCP2UR Technical Product Specification

Intel® Xeon® Gold 6448Y, 225W, 32C	● -	● -	● -	● -	● -	● -	● -	○ -
Intel® Xeon® Gold 6442Y, 225W, 24C	● -	● -	● -	● -	● -	● -	● -	○ -
Intel® Xeon® Gold 6438M, 205W, 32C	● -	● -	● -	● -	● -	● -	● -	● -
Intel® Xeon® Gold 6438N, 205W, 32C	● -	● -	● -	● -	● -	● -	● -	● -
Intel® Xeon® Gold 6438Y+, 205W, 32C	● -	● -	● -	● -	● -	● -	● -	○ -
Intel® Xeon® Gold 5420+, 205W, 28C	● -	● -	● -	● -	● -	● -	● -	● -
Intel® Xeon® Gold 6434, 195W, 8C	● -	● -	● -	● -	● -	○ -	-	-
Intel® Xeon® Gold 6434H, 195W, 8C	● -	● -	● -	● -	● -	○ -	-	-
Intel® Xeon® Gold 6428N, 185W, 32C	● -	● -	● -	● -	● -	● -	● -	● -
Intel® Xeon® Gold 6421N, 185W, 32C	● -	● -	● -	● -	● -	● -	● -	● -
Intel® Xeon® Gold 5418Y, 185W, 24C	● -	● -	● -	● -	● -	● -	● -	● -
Intel® Xeon® Gold 6418H, 185W, 24C	● -	● -	● -	● -	● -	● -	● -	● -
Intel® Xeon® Gold 5412U, 185W, 24C	● -	● -	● -	● -	● -	● -	● -	● -
Intel® Xeon® Gold 6426Y, 185W, 16C	● -	● -	● -	● -	● -	● -	● -	● -
Intel® Xeon® Gold 5418N, 165W, 24C	● -	● -	● -	● -	● -	● -	● -	● -
Intel® Xeon® Gold 5411N, 165W, 24C	● -	● -	● -	● -	● -	● -	● -	● -
Intel® Xeon® Silver 4416+, 165W, 20C	● -	● -	● -	● -	● -	● -	● -	● -
Intel® Xeon® Gold 6416H, 165W, 18C	● -	● -	● -	● -	● -	● -	● -	● -
Intel® Xeon® Gold 5416S, 150W, 16C	● -	● -	● -	● -	● -	● -	● -	● -
Intel® Xeon® Silver 4410Y, 150W, 12C	● -	● -	● -	● -	● -	● -	● -	● -
Intel® Xeon® Gold 5415+, 150W, 8C	● -	● -	● -	● -	● -	● -	● -	● -
Intel® Xeon® Bronze 3408U, 125W, 8C	● -	● -	● -	● -	● -	● -	● -	● -
Intel® Xeon® Silver 4410T, 150W, 10C	● -	● -	● -	● -	● -	● -	● -	● -
<b>Memory Type</b>	<b>Memory Support</b>							
DDR5, DRx8, 1x, 1DPC	● -	● -	● -	● -	● -	● -	● -	● -
DDR5, DRx4, 1x, 1DPC	● -	● -	● -	● -	● -	● -	● -	● -

Intel® Server System M50FCP2UR Technical Product Specification

DDR5, QRx4, 1x, 1DPC	● -	● -	● -	● -	● -	● -	● -	○ -
DDR5, DRx8, 1x, 2DPC	● -	● -	● -	● -	● -	● -	● -	● -
DDR5, DRx4, 1x, 2DPC	● -	● -	● -	● -	● -	● -	● -	● -
DDR5, QRx4, 1x, 2DPC	● -	● -	● -	● -	● -	● -	● -	● -
DDR5, DRx8, 2x, 1DPC	● -	● -	● -	● -	● -	● -	● -	● -
DDR5, DRx4, 2x, 1DPC	● -	● -	● -	● -	● -	● -	● -	● -
DDR5, QRx4, 2x, 1DPC	● -	● -	● -	● -	● -	● -	● -	● -
DDR5, DRx8, 2x, 2DPC	● -	● -	● -	● -	● -	● -	● -	● -
DDR5, DRx4, 2x, 2DPC	● -	● -	● -	● -	● -	● -	● -	● -
DDR5, QRx4, 2x, 2DPC	● -	● -	● -	● -	● -	● -	● -	● -
<b>PCI Card Cooling</b>	<b>Supported Thermal Level</b>							
Riser 1 slot 1	LEVEL7 / -	LEVEL7 / -	LEVEL7 / -	LEVEL7 / -	LEVEL7 / -	LEVEL6 / -	LEVEL6 / -	LEVEL5 / -
Riser 1 slot 2	LEVEL7 / -	LEVEL7 / -	LEVEL7 / -	LEVEL7 / -	LEVEL7 / -	LEVEL7 / -	LEVEL6 / -	LEVEL6 / -
Riser 1 slot 3	LEVEL7 / -	LEVEL7 / -	LEVEL7 / -	LEVEL7 / -	LEVEL7 / -	LEVEL6 / -	LEVEL6 / -	LEVEL5 / -
Riser 2 slot 1	N/A	N/A	N/A	N/A	N/A	N/A	N/A	N/A
Riser 2 slot 2	N/A	N/A	N/A	N/A	N/A	N/A	N/A	N/A
Riser 2 slot 3	N/A	N/A	N/A	N/A	N/A	N/A	N/A	N/A
Riser 3 slot 1	N/A	N/A	N/A	N/A	N/A	N/A	N/A	N/A
Riser 3 slot 2	N/A	N/A	N/A	N/A	N/A	N/A	N/A	N/A
<b>3.5" SAS/SATA SSD</b>	<b>3.5" SAS/SATA SSD Support</b>							
Rated to 60C	-	-	-	-	-	-	-	-
<b>2.5" PCIe NVMe SSD</b>	<b>2.5" PCIe NVMe SSD Support</b>							
NVMe TDP = 25W, Rated to 70C	● -	● -	● -	● -	● -	● -	● -	● -
<b>GPGPU card type</b>	<b>GPGPU card Support</b>							

Intel® Server System M50FCP2UR Technical Product Specification

Nvidia DW GPGPU - A16/A30/A40/A100-40G/A100-80G/H100	-	-	-	-	-	-	-	-
Intel® FPGA PAC D5005 - DW - 225W	-	-	-	-	-	-	-	-
PonteVecchio - DW - 300W	-	-	-	-	-	-	-	-
Intel ATS M1 - FH, 3/4 Length, Single Slot - 150W	-	-	-	-	-	-	-	-
Nvidia Tesla A2 - LP- 60W	○ -	-	-	-	-	-	-	-
Intel ATS M3 - LP- 75W	○ -	-	-	-	-	-	-	-
<b>Rear SSD above PSUs</b>	<b>Rear SSD Support</b>							
SATA SSD, Rated to 70C	●-	●-	●-	●-	●-	●-	●-	●-
<b>M.2 SSD</b>	<b>M.2 NVMe SSD Support</b>							
Micron 7400/7450 series (rated to 70C, TDP = 8W)	●-	●-	●-	-	-	-	-	-
Other NVMe/SATA SSD in APlist (rated to 70C)	●-	●-	●-	●-	●-	●-	-	-
<b>PSU</b>	<b>PSU Support (CPU power: 300W)</b>							
2100W	●-	●-	●-	●-	●-	●-	●-	-
1600W	●-	●-	●-	●-	●-	●-	●-	-
1300W	●-	●-	●-	●-	●-	●-	●-	-
<b>OCP V3</b>	<b>OCP V3 Support</b>							
OCP 25W w/ class-2 QSFP	●-	●-	●-	●-	●-	●-	●-	-
<b>Battery Backup</b>	<b>Battery Backup Support</b>							
BBU inlet (rated to 45C)	●-	●-	●-	●-	●-	●-	-	-

**Table 68. Thermal Configuration Matrix with Single 4<sup>th</sup> Gen Processors Installed Normal Operating Mode (Table 2 of 4) (M50FCP2UR208 x24 Drive with 1U Heat Sink)**

Intel® Server M50FCP2UR224, 1U Heatsink, 1 Socket, Air-cooled								
Max Ambient Temperature	15°C	20°C	25°C	27°C	32°C	35°C	40°C	45°C
CPU SKU	CPU Support (TDP 205W)							
Intel® Xeon® Gold 6438M, 205W, 32C	● -	● -	● -	● -	● -	● -	● -	○ -
Intel® Xeon® Gold 6438N, 205W, 32C	● -	● -	● -	● -	● -	● -	● -	○ -
Intel® Xeon® Gold 6438Y+, 205W, 32C	● -	● -	● -	● -	● -	○ -	-	-
Intel® Xeon® Gold 5420+, 205W, 28C	● -	● -	● -	● -	● -	● -	○ -	-
Intel® Xeon® Gold 6434, 195W, 8C	● -	● -	○ -	○ -	-	-	-	-
Intel® Xeon® Gold 6434H, 195W, 8C	● -	● -	○ -	○ -	-	-	-	-
Intel® Xeon® Gold 6428N, 185W, 32C	● -	● -	● -	● -	● -	● -	● -	○ -
Intel® Xeon® Gold 6421N, 185W, 32C	● -	● -	● -	● -	● -	● -	● -	○ -
Intel® Xeon® Gold 5418Y, 185W, 24C	● -	● -	● -	● -	● -	● -	● -	○ -
Intel® Xeon® Gold 6418H, 185W, 24C	● -	● -	● -	● -	● -	● -	● -	○ -
Intel® Xeon® Gold 5412U, 185W, 24C	● -	● -	● -	● -	● -	● -	● -	○ -
Intel® Xeon® Gold 6426Y, 185W, 16C	● -	● -	● -	● -	● -	● -	● -	○ -
Intel® Xeon® Gold 5418N, 165W, 24C	● -	● -	● -	● -	● -	● -	● -	● -
Intel® Xeon® Gold 5411N, 165W, 24C	● -	● -	● -	● -	● -	● -	● -	● -
Intel® Xeon® Silver 4416+, 165W, 20C	● -	● -	● -	● -	● -	● -	● -	● -
Intel® Xeon® Gold 6416H, 165W, 18C	● -	● -	● -	● -	● -	● -	● -	● -
Intel® Xeon® Gold 5416S, 150W, 16C	● -	● -	● -	● -	● -	● -	● -	● -
Intel® Xeon® Silver 4410Y, 150W, 12C	● -	● -	● -	● -	● -	● -	● -	● -
Intel® Xeon® Gold 5415+, 150W, 8C	● -	● -	● -	● -	● -	● -	● -	● -
Intel® Xeon® Bronze 3408U, 125W, 8C	● -	● -	● -	● -	● -	● -	● -	● -
Intel® Xeon® Silver 4410T, 150W, 10C	● -	● -	● -	● -	● -	● -	● -	● -

Memory Type	Memory Support							
DDR5, DRx8, 1x, 1DPC	● -	● -	● -	● -	● -	● -	● -	○ -
DDR5, DRx4, 1x, 1DPC	● -	● -	● -	● -	● -	● -	● -	○ -
DDR5, QRx4, 1x, 1DPC	● -	● -	● -	● -	● -	● -	● -	○ -
DDR5, DRx8, 1x, 2DPC	● -	● -	● -	● -	● -	● -	● -	○ -
DDR5, DRx4, 1x, 2DPC	● -	● -	● -	● -	● -	● -	● -	○ -
DDR5, QRx4, 1x, 2DPC	● -	● -	● -	● -	● -	● -	● -	○ -
DDR5, DRx8, 2x, 1DPC	● -	● -	● -	● -	● -	● -	● -	○ -
DDR5, DRx4, 2x, 1DPC	● -	● -	● -	● -	● -	● -	● -	○ -
DDR5, QRx4, 2x, 1DPC	● -	● -	● -	● -	● -	● -	● -	○ -
DDR5, DRx8, 2x, 2DPC	● -	● -	● -	● -	● -	● -	● -	○ -
DDR5, DRx4, 2x, 2DPC	● -	● -	● -	● -	● -	● -	● -	○ -
DDR5, QRx4, 2x, 2DPC	● -	● -	● -	● -	● -	● -	● -	○ -
PCI Card Cooling	Supported Thermal Level							
Riser 1 slot 1	LEVEL7 / -	LEVEL7 / -	LEVEL7 / -	LEVEL7 / -	LEVEL7 / -	LEVEL6 / -	LEVEL6 / -	LEVEL5 / -
Riser 1 slot 2	LEVEL7 / -	LEVEL7 / -	LEVEL7 / -	LEVEL7 / -	LEVEL6 / -	LEVEL6 / -	LEVEL5 / -	LEVEL4 / -
Riser 1 slot 3	LEVEL7 / -	LEVEL7 / -	LEVEL7 / -	LEVEL7 / -	LEVEL6 / -	LEVEL6 / -	LEVEL5 / -	LEVEL4 / -
Riser 2 slot 1	N/A	N/A	N/A	N/A	N/A	N/A	N/A	N/A
Riser 2 slot 2	N/A	N/A	N/A	N/A	N/A	N/A	N/A	N/A
Riser 2 slot 3	N/A	N/A	N/A	N/A	N/A	N/A	N/A	N/A
Riser 3 slot 1	N/A	N/A	N/A	N/A	N/A	N/A	N/A	N/A
Riser 3 slot 2	N/A	N/A	N/A	N/A	N/A	N/A	N/A	N/A
3.5" SAS/SATA SSD	3.5" SAS/SATA SSD Support							
Rated to 60C	-	-	-	-	-	-	-	-
2.5" PCIe NVMe SSD	2.5" PCIe NVMe SSD Support							



Intel® Server System M50FCP2UR Technical Product Specification

NVMe TDP = 25W, Rated to 70C	● -	● -	● -	● -	● -	● -	● -	● -
<b>GPGPU card type</b>	<b>GPGPU card Support</b>							
Nvidia DW GPGPU - A16/A30/A40/A100-40G/A100-80G/H100	-	-	-	-	-	-	-	-
Intel® FPGA PAC D5005 - DW - 225W	-	-	-	-	-	-	-	-
PonteVecchio - DW - 300W	-	-	-	-	-	-	-	-
Intel ATS M1 - FH, 3/4 Length, Single Slot - 150W	● -	● -	○ -	-	-	-	-	-
Nvidia Tesla A2 - LP- 60W	● -	-	-	-	-	-	-	-
Intel ATS M3 - LP- 75W	● -	● -	-	-	-	-	-	-
<b>Rear SSD above PSUs</b>	<b>Rear SSD Support</b>							
SATA SSD, Rated to 70C	● -	● -	● -	● -	● -	● -	● -	● -
<b>M.2 SSD</b>	<b>M.2 NVMe SSD Support</b>							
Micron 7400/7450 series (rated to 70C, TDP = 8W)	● -	● -	● -	● -	-	-	-	-
Other NVMe/SATA SSD in APlist (rated to 70C)	● -	● -	● -	● -	● -	● -	-	-
<b>PSU</b>	<b>PSU Support (CPU power : 205W)</b>							
2100W	● -	● -	● -	● -	● -	● -	● -	● -
1600W	● -	● -	● -	● -	● -	● -	● -	● -
1300W	● -	● -	● -	● -	● -	● -	● -	● -
<b>OCP V3</b>	<b>OCP V3 Support</b>							
OCP 25W w/ class-2 QSFP	● -	● -	● -	● -	● -	● -	● -	-
<b>Battery Backup</b>	<b>Battery Backup Support</b>							
BBU inlet (rated to 45C)	● -	● -	● -	● -	● -	● -	-	-

**Table 69. Thermal Configuration Matrix with Single 5<sup>th</sup> Gen Processors Installed Normal Operating Mode (Table 3 of 4) (M50FCP2UR208 x24 Drive with 2U Heat Sink)**

Intel® Server M50FCPR2UR208X24, 2U Heatsink, 1 Socket, Air-cooled								
Max Ambient Temperature	15°C	20°C	25°C	27°C	32°C	35°C	40°C	45°C
<b>CPU SKU</b>	<b>CPU Support (TDP 300W)</b>							
Intel® Xeon® Platinum 8571N, 300W, 52C	● -	● -	● -	● -	● -	● -	○ -	● -
Intel® Xeon® Platinum 8554U, 300W, 48C	● -	● -	● -	● -	● -	● -	○ -	● -
Intel® Xeon® Platinum 8581V, 270W, 60C	● -	● -	● -	● -	● -	● -	○ -	● -
Intel® Xeon® Gold 6554S, 270W, 36C	● -	● -	● -	● -	● -	● -	○ -	● -
Intel® Xeon® Gold 6530, 270W, 32C	● -	● -	● -	● -	● -	● -	○ -	● -
Intel® Xeon® Platinum 8562Y+, 300W, 32C	● -	● -	● -	● -	● -	○ -	-	-
Intel® Xeon® Gold 6544Y, 270W, 16C	● -	● -	● -	● -	● -	○ -	-	-
Intel® Xeon® Gold 6548Y+, 250W, 32C	● -	● -	● -	● -	● -	● -	● -	○ -
Intel® Xeon® Gold 6548N, 250W, 32C	● -	● -	● -	● -	● -	● -	● -	○ -
Intel® Xeon® Gold 6542Y, 250W, 24C	● -	● -	● -	● -	● -	● -	● -	○ -
Intel® Xeon® Gold 6538Y+, 225W, 32C	● -	● -	● -	● -	● -	● -	● -	○ -
Intel® Xeon® Gold 6538N, 205W, 32C	● -	● -	● -	● -	● -	● -	● -	● -
Intel® Xeon® Gold 5520+, 205W, 28C	● -	● -	● -	● -	● -	● -	● -	● -
Intel® Xeon® Gold 6526Y, 195W, 16C	● -	● -	● -	● -	● -	● -	● -	● -
Intel® Xeon® Gold 6534, 195W, 8C	● -	● -	● -	● -	● -	○ -	-	-
Intel® Xeon® Gold 5512U, 185W, 28C	● -	● -	● -	● -	● -	● -	● -	● -
Intel® Xeon® Gold 5515+, 165W, 8C	● -	● -	● -	● -	● -	● -	● -	● -
Intel® Xeon® Silver 4516Y+, 185W, 24C	● -	● -	● -	● -	● -	● -	● -	● -
Intel® Xeon® Gold 4514Y, 150W, 16C	● -	● -	● -	● -	● -	● -	● -	● -
Intel® Xeon® Silver 4510, 150W, 12C	● -	● -	● -	● -	● -	● -	● -	● -
<b>Memory Type</b>	<b>Memory Support</b>							

Intel® Server System M50FCP2UR Technical Product Specification

DDR5, DRx8, 1x, 1DPC	●●	●●	●●	●●	●●	●○	○-	●○
DDR5, DRx4, 1x, 1DPC	●○	●○	●○	●○	●○	●○	●○	●-
DDR5, QRx4, 1x, 1DPC	●-	●-	●-	●-	●-	●-	●-	●-
DDR5, DRx8, 1x, 2DPC	●-	●-	●-	●-	●-	●-	●-	●-
DDR5, DRx4, 1x, 2DPC	●-	●-	●-	●-	●-	●-	●-	○-
DDR5, QRx4, 1x, 2DPC	●-	●-	●-	●-	●-	●-	●-	●-
DDR5, DRx8, 2x, 1DPC	●-	●-	●-	●-	●-	●-	●-	●-
DDR5, DRx4, 2x, 1DPC	●-	●-	●-	●-	●-	●-	●-	●-
DDR5, QRx4, 2x, 1DPC	●-	●-	●-	●-	●-	●-	●-	●-
DDR5, DRx8, 2x, 2DPC	●-	●-	●-	●-	●-	●-	●-	●-
DDR5, DRx4, 2x, 2DPC	●-	●-	●-	●-	●-	●-	●-	●-
DDR5, QRx4, 2x, 2DPC	●-	●-	●-	●-	●-	●-	●-	●-
<b>PCI Card Cooling</b>	<b>Supported Thermal Level</b>							
Riser 1 slot 1	LEVEL7 / -	LEVEL7 / -	LEVEL7 / -	LEVEL7 / -	LEVEL7 / -	LEVEL6 / -	LEVEL6 / -	LEVEL5 / -
Riser 1 slot 2	LEVEL7 / -	LEVEL7 / -	LEVEL7 / -	LEVEL7 / -	LEVEL7 / -	LEVEL7 / -	LEVEL6 / -	LEVEL6 / -
Riser 1 slot 3	LEVEL7 / -	LEVEL7 / -	LEVEL7 / -	LEVEL7 / -	LEVEL7 / -	LEVEL6 / -	LEVEL6 / -	LEVEL5 / -
Riser 2 slot 1	N/A	N/A	N/A	N/A	N/A	N/A	N/A	N/A
Riser 2 slot 2	N/A	N/A	N/A	N/A	N/A	N/A	N/A	N/A
Riser 2 slot 3	N/A	N/A	N/A	N/A	N/A	N/A	N/A	N/A
Riser 3 slot 1	N/A	N/A	N/A	N/A	N/A	N/A	N/A	N/A
Riser 3 slot 2	N/A	N/A	N/A	N/A	N/A	N/A	N/A	N/A
<b>3.5" SAS/SATA SSD</b>	<b>3.5" SAS/SATA SSD Support</b>							
Rated to 60C	-	-	-	-	-	-	-	-
<b>2.5" PCIe NVMe SSD</b>	<b>2.5" PCIe NVMe SSD Support</b>							
NVMe TDP = 25W, Rated to 70C	●-	●-	●-	●-	●-	●-	●-	●-

<b>GPGPU card type</b>	<b>GPGPU card Support</b>							
Nvidia DW GPGPU - A16/A30/A40/A100-40G/A100-80G/H100	-	-	-	-	-	-	-	-
Intel® FPGA PAC D5005 - DW - 225W	-	-	-	-	-	-	-	-
PonteVecchio - DW - 300W	-	-	-	-	-	-	-	-
Intel ATS M1 - FH, 3/4 Length, Single Slot - 150W	-	-	-	-	-	-	-	-
Nvidia Tesla A2 - LP- 60W	○-	-	-	-	-	-	-	-
Intel ATS M3 - LP- 75W	○-	-	-	-	-	-	-	-
<b>Rear SSD above PSUs</b>	<b>Rear SSD Support</b>							
SATA SSD, Rated to 70C	●-	●-	●-	●-	●-	●-	●-	●-
<b>M.2 SSD</b>	<b>M.2 NVMe SSD Support</b>							
Micron 7400/7450 series (rated to 70C, TDP = 8W)	●-	●-	●-	-	-	-	-	-
Other NVMe/SATA SSD in APlist (rated to 70C)	●-	●-	●-	●-	●-	●-	-	-
<b>PSU</b>	<b>PSU Support (Fan normal : 350W / Fan fail : 205W)</b>							
2100W	●-	●-	●-	●-	●-	●-	●-	-
1600W	●-	●-	●-	●-	●-	●-	●-	-
1300W	●-	●-	●-	●-	●-	●-	●-	-
<b>OCP V3</b>	<b>OCP V3 Support</b>							
OCP 25W w/ class-2 QSFP	●-	●-	●-	●-	●-	●-	●-	-
<b>Battery Backup</b>	<b>Battery Backup Support</b>							
BBU inlet (rated to 45C)	●-	●-	●-	●-	●-	●-	-	-

**Table 70. Thermal Configuration Matrix with Single 5<sup>th</sup> Gen Processors Installed Normal Operating Mode (Table 4 of 4) (M50FCP2UR208 x24 Drive with 1U Heat Sink)**

Intel® Server M50FCPR2UR208X24, 1U Heatsink, 1 Socket, Air-cooled								
Max Ambient Temperature	15°C	20°C	25°C	27°C	32°C	35°C	40°C	45°C
<b>CPU SKU</b>	<b>CPU Support (TDP 205W)</b>							
Intel® Xeon® Gold 6538N, 205W, 32C	● -	● -	● -	● -	● -	● -	● -	-
Intel® Xeon® Gold 5520+, 205W, 28C	● -	● -	● -	● -	● -	● -	● -	○ -
Intel® Xeon® Gold 6526Y, 195W, 16C	● -	● -	● -	● -	● -	● -	● -	○ -
Intel® Xeon® Gold 6534, 195W, 8C	● -	● -	○ -	○ -	-	-	-	-
Intel® Xeon® Gold 5512U, 185W, 28C	● -	● -	● -	● -	● -	● -	● -	● -
Intel® Xeon® Gold 5515+, 165W, 8C	● -	● -	● -	● -	● -	● -	● -	○ -
Intel® Xeon® Silver 4516Y+, 185W, 24C	● -	● -	● -	● -	● -	● -	● -	-
Intel® Xeon® Gold 4514Y, 150W, 16C	● -	● -	● -	● -	● -	● -	● -	● -
Intel® Xeon® Silver 4510, 150W, 12C	● -	● -	● -	● -	● -	● -	● -	● -
<b>Memory Type</b>	<b>Memory Support</b>							
DDR5, DRx8, 1x, 1DPC	● -	● -	● -	● -	● -	● -	● -	○ -
DDR5, DRx4, 1x, 1DPC	● -	● -	● -	● -	● -	● -	● -	○ -
DDR5, QRx4, 1x, 1DPC	● -	● -	● -	● -	● -	● -	● -	○ -
DDR5, DRx8, 1x, 2DPC	● -	● -	● -	● -	● -	● -	● -	○ -
DDR5, DRx4, 1x, 2DPC	● -	● -	● -	● -	● -	● -	● -	○ -
DDR5, QRx4, 1x, 2DPC	● -	● -	● -	● -	● -	● -	● -	○ -
DDR5, DRx8, 2x, 1DPC	● -	● -	● -	● -	● -	● -	● -	○ -
DDR5, DRx4, 2x, 1DPC	● -	● -	● -	● -	● -	● -	● -	○ -
DDR5, QRx4, 2x, 1DPC	● -	● -	● -	● -	● -	● -	● -	○ -
DDR5, DRx8, 2x, 2DPC	● -	● -	● -	● -	● -	● -	● -	○ -
DDR5, DRx4, 2x, 2DPC	● -	● -	● -	● -	● -	● -	● -	○ -

Intel® Server System M50FCP2UR Technical Product Specification

DDR5, QRx4, 2x, 2DPC	● -	● -	● -	● -	● -	● -	● -	○ -
<b>PCI Card Cooling</b>	<b>Supported Thermal Level</b>							
Riser 1 slot 1	LEVEL7 / -	LEVEL7 / -	LEVEL7 / -	LEVEL7 / -	LEVEL7 / -	LEVEL6 / -	LEVEL6 / -	LEVEL5 / -
Riser 1 slot 2	LEVEL7 / -	LEVEL7 / -	LEVEL7 / -	LEVEL7 / -	LEVEL6 / -	LEVEL6 / -	LEVEL5 / -	LEVEL4 / -
Riser 1 slot 3	LEVEL7 / -	LEVEL7 / -	LEVEL7 / -	LEVEL7 / -	LEVEL6 / -	LEVEL6 / -	LEVEL5 / -	LEVEL4 / -
Riser 2 slot 1	N/A	N/A	N/A	N/A	N/A	N/A	N/A	N/A
Riser 2 slot 2	N/A	N/A	N/A	N/A	N/A	N/A	N/A	N/A
Riser 2 slot 3	N/A	N/A	N/A	N/A	N/A	N/A	N/A	N/A
Riser 3 slot 1	N/A	N/A	N/A	N/A	N/A	N/A	N/A	N/A
Riser 3 slot 2	N/A	N/A	N/A	N/A	N/A	N/A	N/A	N/A
<b>3.5" SAS/SATA SSD</b>	<b>3.5" SAS/SATA SSD Support</b>							
Rated to 60C	-	-	-	-	-	-	-	-
<b>2.5" PCIe NVMe SSD</b>	<b>2.5" PCIe NVMe SSD Support</b>							
NVMe TDP = 25W, Rated to 70C	● -	● -	● -	● -	● -	● -	● -	● -
<b>GPGPU card type</b>	<b>GPGPU card Support</b>							
Nvidia DW GPGPU - A16/A30/A40/A100-40G/A100-80G/H100	-	-	-	-	-	-	-	-
Intel® FPGA PAC D5005 - DW - 225W	-	-	-	-	-	-	-	-
PonteVecchio - DW - 300W	-	-	-	-	-	-	-	-
Intel ATS M1 - FH, 3/4 Length, Single Slot - 150W	● -	● -	○ -	-	-	-	-	-
Nvidia Tesla A2 - LP- 60W	● -	-	-	-	-	-	-	-
Intel ATS M3 - LP- 75W	● -	● -	-	-	-	-	-	-
<b>Rear SSD above PSUs</b>	<b>Rear SSD Support</b>							
SATA SSD, Rated to 70C	● -	● -	● -	● -	● -	● -	● -	● -

Intel® Server System M50FCP2UR Technical Product Specification

M.2 SSD	M.2 NVMe SSD Support							
Micron 7400/7450 series (rated to 70C, TDP = 8W)	● -	● -	● -	● -	-	-	-	-
Other NVMe/SATA SSD in APlist (rated to 70C)	● -	● -	● -	● -	● -	● -	-	-
PSU	PSU Support (Fan normal: 350W / Fan fail : 205W)							
2100W	● -	● -	● -	● -	● -	● -	● -	● -
1600W	● -	● -	● -	● -	● -	● -	● -	● -
1300W	● -	● -	● -	● -	● -	● -	● -	● -
OCP V3	OCP V3 Support							
OCP 25W w/ class-2 QSFP	● -	● -	● -	● -	● -	● -	● -	-
Battery Backup	Battery Backup Support							
BBU inlet (rated to 45C)	● -	● -	● -	● -	● -	● -	-	-

**Table 71. Thermal Configuration Matrix with Single 4<sup>th</sup> Gen Processors Installed Normal Operating Mode (Table 1 of 4) (M50FCP2UR x16 Drive with 2U Heat Sink)**

Intel® Server M50FCPR2UR2216, 2U Heatsink, 1 Socket, Air-cooled								
Max Ambient Temperature	15°C	20°C	25°C	27°C	32°C	35°C	40°C	45°C
CPU SKU	CPU Support (TDP 350W)							
Intel® Xeon® Platinum 8490H, 350W, 60C	● -	● -	● -	● -	● -	● -	● -	-
Intel® Xeon® Platinum 8480+, 350W, 56C	● -	● -	● -	● -	● -	● -	● -	-
Intel® Xeon® Platinum 8470Q, 350W, 52C	● -	● -	○ -	○ -	-	-	-	-
Intel® Xeon® Platinum 8470, 350W, 52C	● -	● -	● -	● -	● -	● -	● -	-
Intel® Xeon® Platinum 8468, 350W, 48C	● -	● -	● -	● -	● -	● -	● -	-
Intel® Xeon® Platinum 8458P, 350W, 44C	● -	● -	● -	● -	● -	● -	● -	-
Intel® Xeon® Platinum 8468V, 330W, 48C	● -	● -	● -	● -	● -	● -	● -	-

Intel® Server System M50FCP2UR Technical Product Specification

Intel® Xeon® Platinum 8468H, 330W, 48C	● -	● -	● -	● -	● -	● -	● -	-
Intel® Xeon® Platinum 8460H, 330W, 40C	● -	● -	● -	● -	● -	● -	● -	-
Intel® Xeon® Platinum 8471N, 300W, 52C	● -	● -	● -	● -	● -	● -	● -	-
Intel® Xeon® Platinum 8470N, 300W, 52C	● -	● -	● -	● -	● -	● -	● -	-
Intel® Xeon® Platinum 8461V, 300W, 48C	● -	● -	● -	● -	● -	● -	● -	-
Intel® Xeon® Platinum 8460Y+, 300W, 40C	● -	● -	● -	● -	● -	● -	● -	-
Intel® Xeon® Platinum 8452Y, 300W, 36C	● -	● -	● -	● -	● -	● -	● -	-
Intel® Xeon® Gold 6454S, 270W, 32C	● -	● -	● -	● -	● -	● -	● -	○ -
Intel® Xeon® Platinum 8454H, 270W, 32C	● -	● -	● -	● -	● -	● -	● -	○ -
Intel® Xeon® Gold 6430, 270W, 32C	● -	● -	● -	● -	● -	● -	● -	○ -
Intel® Xeon® Platinum 8444H, 270W, 16C	● -	● -	● -	● -	● -	● -	● -	○ -
Intel® Xeon® Gold 6414U, 250W, 32C	● -	● -	● -	● -	● -	● -	● -	● -
Intel® Xeon® Platinum 8450H, 250W, 28C	● -	● -	● -	● -	● -	● -	● -	● -
Intel® Xeon® Gold 6458Q, 350W, 32C	● -	○ -	○ -	-	-	-	-	-
Intel® Xeon® Platinum 8462Y+, 300W, 32C	● -	● -	● -	● -	● -	● -	○ -	-
Intel® Xeon® Gold 6444Y, 270W, 16C	● -	● -	● -	● -	● -	● -	○ -	-
Intel® Xeon® Gold 6448H, 250W, 32C	● -	● -	● -	● -	● -	● -	● -	● -
Intel® Xeon® Gold 6448Y, 225W, 32C	● -	● -	● -	● -	● -	● -	● -	● -
Intel® Xeon® Gold 6442Y, 225W, 24C	● -	● -	● -	● -	● -	● -	● -	● -
Intel® Xeon® Gold 6438M, 205W, 32C	● -	● -	● -	● -	● -	● -	● -	● -
Intel® Xeon® Gold 6438N, 205W, 32C	● -	● -	● -	● -	● -	● -	● -	● -
Intel® Xeon® Gold 6438Y+, 205W, 32C	● -	● -	● -	● -	● -	● -	● -	● -
Intel® Xeon® Gold 5420+, 205W, 28C	● -	● -	● -	● -	● -	● -	● -	● -
Intel® Xeon® Gold 6434, 195W, 8C	● -	● -	● -	● -	● -	● -	○ -	-
Intel® Xeon® Gold 6434H, 195W, 8C	● -	● -	● -	● -	● -	● -	○ -	-
Intel® Xeon® Gold 6428N, 185W, 32C	● -	● -	● -	● -	● -	● -	● -	● -



Intel® Server System M50FCP2UR Technical Product Specification

Intel® Xeon® Gold 6421N, 185W, 32C	● -	● -	● -	● -	● -	● -	● -	● -
Intel® Xeon® Gold 5418Y, 185W, 24C	● -	● -	● -	● -	● -	● -	● -	● -
Intel® Xeon® Gold 6418H, 185W, 24C	● -	● -	● -	● -	● -	● -	● -	● -
Intel® Xeon® Gold 5412U, 185W, 24C	● -	● -	● -	● -	● -	● -	● -	● -
Intel® Xeon® Gold 6426Y, 185W, 16C	● -	● -	● -	● -	● -	● -	● -	● -
Intel® Xeon® Gold 5418N, 165W, 24C	● -	● -	● -	● -	● -	● -	● -	● -
Intel® Xeon® Gold 5411N, 165W, 24C	● -	● -	● -	● -	● -	● -	● -	● -
Intel® Xeon® Silver 4416+, 165W, 20C	● -	● -	● -	● -	● -	● -	● -	● -
Intel® Xeon® Gold 6416H, 165W, 18C	● -	● -	● -	● -	● -	● -	● -	● -
Intel® Xeon® Gold 5416S, 150W, 16C	● -	● -	● -	● -	● -	● -	● -	● -
Intel® Xeon® Silver 4410Y, 150W, 12C	● -	● -	● -	● -	● -	● -	● -	● -
Intel® Xeon® Gold 5415+, 150W, 8C	● -	● -	● -	● -	● -	● -	● -	● -
Intel® Xeon® Bronze 3408U, 125W, 8C	● -	● -	● -	● -	● -	● -	● -	● -
Intel® Xeon® Silver 4410T, 150W, 10C	● -	● -	● -	● -	● -	● -	● -	● -
<b>Memory Type</b>	<b>Memory Support</b>							
DDR5, DRx8, 1x, 1DPC	● -	● -	● -	● -	● -	● -	○ -	○ -
DDR5, DRx4, 1x, 1DPC	● -	● -	● -	● -	● -	● -	○ -	○ -
DDR5, QRx4, 1x, 1DPC	● -	● -	● -	● -	● -	● -	○ -	○ -
DDR5, DRx8, 1x, 2DPC	● -	● -	● -	● -	● -	● -	○ -	○ -
DDR5, DRx4, 1x, 2DPC	● -	● -	● -	● -	● -	● -	○ -	○ -
DDR5, QRx4, 1x, 2DPC	● -	● -	● -	● -	● -	● -	○ -	○ -
DDR5, DRx8, 2x, 1DPC	● -	● -	● -	● -	● -	● -	○ -	○ -
DDR5, DRx4, 2x, 1DPC	● -	● -	● -	● -	● -	● -	○ -	○ -
DDR5, QRx4, 2x, 1DPC	● -	● -	● -	● -	● -	● -	○ -	○ -
DDR5, DRx8, 2x, 2DPC	● -	● -	● -	● -	● -	● -	○ -	○ -
DDR5, DRx4, 2x, 2DPC	● -	● -	● -	● -	● -	● -	○ -	○ -

Intel® Server System M50FCP2UR Technical Product Specification

DDR5, QRx4, 2x, 2DPC	● -	● -	● -	● -	● -	● -	○ -	○ -
<b>PCI Card Cooling</b>	<b>Supported Thermal Level</b>							
Riser 1 slot 1	LEVEL7 / -	LEVEL7 / -	LEVEL7 / -	LEVEL7 / -	LEVEL7 / -	LEVEL7 / -	LEVEL6 / -	LEVEL6 / -
Riser 1 slot 2	LEVEL7 / -	LEVEL7 / -	LEVEL7 / -	LEVEL7 / -	LEVEL7 / -	LEVEL7 / -	LEVEL6 / -	LEVEL6 / -
Riser 1 slot 3	LEVEL7 / -	LEVEL7 / -	LEVEL7 / -	LEVEL7 / -	LEVEL7 / -	LEVEL7 / -	LEVEL6 / -	LEVEL5 / -
Riser 2 slot 1	N/A	N/A	N/A	N/A	N/A	N/A	N/A	N/A
Riser 2 slot 2	N/A	N/A	N/A	N/A	N/A	N/A	N/A	N/A
Riser 2 slot 3	N/A	N/A	N/A	N/A	N/A	N/A	N/A	N/A
Riser 3 slot 1	N/A	N/A	N/A	N/A	N/A	N/A	N/A	N/A
Riser 3 slot 2	N/A	N/A	N/A	N/A	N/A	N/A	N/A	N/A
<b>3.5" SAS/SATA SSD</b>	<b>3.5" SAS/SATA SSD Support</b>							
Rated to 60C	-	-	-	-	-	-	-	-
<b>2.5" PCIe NVMe SSD</b>	<b>2.5" PCIe NVMe SSD Support</b>							
NVMe TDP = 25W, Rated to 70C	● -	● -	● -	● -	● -	● -	● -	-
<b>GPGPU card type</b>	<b>GPGPU card Support</b>							
Nvidia DW GPGPU - A16/A30/A40/A100-40G/A100-80G/H100	-	-	-	-	-	-	-	-
Intel® FPGA PAC D5005 - DW - 225W	-	-	-	-	-	-	-	-
PonteVecchio - DW - 300W	-	-	-	-	-	-	-	-
Intel ATS M1 - FH, 3/4 Length, Single Slot - 150W	-	-	-	-	-	-	-	-
Nvidia Tesla A2 - LP- 60W	● -	● -	● -	-	-	-	-	-
Intel ATS M3 - LP- 75W	● -	● -	● -	● -	● -	-	-	-
<b>Rear SSD above PSUs</b>	<b>Rear SSD Support</b>							
SATA SSD, Rated to 70C	● -	● -	● -	● -	● -	● -	● -	● -

Intel® Server System M50FCP2UR Technical Product Specification

M.2 SSD	M.2 NVMe SSD Support							
Micron 7400/7450 series (rated to 70C, TDP = 8W)	● -	● -	● -	● -	-	-	-	-
Other NVMe/SATA SSD in APlist (rated to 70C)	● -	● -	● -	● -	● -	● -	● -	-
PSU	PSU Support (CPU power: 350W)							
2100W	● -	● -	● -	● -	● -	● -	● -	-
1600W	● -	● -	● -	● -	● -	● -	● -	-
1300W	● -	● -	● -	● -	● -	● -	● -	-
OCP V3	OCP V3 Support							
OCP 25W w/ class-2 QSFP	● -	● -	● -	● -	● -	● -	● -	● -
Battery Backup	Battery Backup Support							
BBU inlet (rated to 45C)	● -	● -	● -	● -	● -	● -	-	-

**Table 72. Thermal Configuration Matrix with Single 4<sup>th</sup> Gen Processors Installed Normal Operating Mode (Table 2 of 4) (M50FCP2UR x16 Drive with 1U Heat Sink)**

Intel® Server M50FCPR2UR2216, 1U Heatsink, 1 Socket, Air-cooled								
Max Ambient Temperature	15°C	20°C	25°C	27°C	32°C	35°C	40°C	45°C
CPU SKU	CPU Support (TDP 205W)							
Intel® Xeon® Gold 6438M, 205W, 32C	● -	● -	● -	● -	● -	● -	● -	○ -
Intel® Xeon® Gold 6438N, 205W, 32C	● -	● -	● -	● -	● -	● -	● -	○ -
Intel® Xeon® Gold 6438Y+, 205W, 32C	● -	● -	● -	● -	● -	○ -	-	-
Intel® Xeon® Gold 5420+, 205W, 28C	● -	● -	● -	● -	● -	● -	● -	○ -
Intel® Xeon® Gold 6434, 195W, 8C	● -	● -	○ -	○ -	-	-	-	-
Intel® Xeon® Gold 6434H, 195W, 8C	● -	● -	○ -	○ -	-	-	-	-
Intel® Xeon® Gold 6428N, 185W, 32C	● -	● -	● -	● -	● -	● -	● -	● -
Intel® Xeon® Gold 6421N, 185W, 32C	● -	● -	● -	● -	● -	● -	● -	● -

Intel® Server System M50FCP2UR Technical Product Specification

Intel® Xeon® Gold 5418Y, 185W, 24C	● -	● -	● -	● -	● -	● -	● -	○ -
Intel® Xeon® Gold 6418H, 185W, 24C	● -	● -	● -	● -	● -	● -	● -	○ -
Intel® Xeon® Gold 5412U, 185W, 24C	● -	● -	● -	● -	● -	● -	● -	○ -
Intel® Xeon® Gold 6426Y, 185W, 16C	● -	● -	● -	● -	● -	● -	● -	○ -
Intel® Xeon® Gold 5418N, 165W, 24C	● -	● -	● -	● -	● -	● -	● -	● -
Intel® Xeon® Gold 5411N, 165W, 24C	● -	● -	● -	● -	● -	● -	● -	● -
Intel® Xeon® Silver 4416+, 165W, 20C	● -	● -	● -	● -	● -	● -	● -	● -
Intel® Xeon® Gold 6416H, 165W, 18C	● -	● -	● -	● -	● -	● -	● -	● -
Intel® Xeon® Gold 5416S, 150W, 16C	● -	● -	● -	● -	● -	● -	● -	● -
Intel® Xeon® Silver 4410Y, 150W, 12C	● -	● -	● -	● -	● -	● -	● -	● -
Intel® Xeon® Gold 5415+, 150W, 8C	● -	● -	● -	● -	● -	● -	● -	● -
Intel® Xeon® Bronze 3408U, 125W, 8C	● -	● -	● -	● -	● -	● -	● -	● -
Intel® Xeon® Silver 4410T, 150W, 10C	● -	● -	● -	● -	● -	● -	● -	● -
<b>Memory Type</b>	<b>Memory Support</b>							
DDR5, DRx8, 1x, 1DPC	● -	● -	● -	● -	● -	● -	● -	○ -
DDR5, DRx4, 1x, 1DPC	● -	● -	● -	● -	● -	● -	● -	○ -
DDR5, QRx4, 1x, 1DPC	● -	● -	● -	● -	● -	● -	● -	○ -
DDR5, DRx8, 1x, 2DPC	● -	● -	● -	● -	● -	● -	● -	○ -
DDR5, DRx4, 1x, 2DPC	● -	● -	● -	● -	● -	● -	● -	○ -
DDR5, QRx4, 1x, 2DPC	● -	● -	● -	● -	● -	● -	● -	○ -
DDR5, DRx8, 2x, 1DPC	● -	● -	● -	● -	● -	● -	● -	○ -
DDR5, DRx4, 2x, 1DPC	● -	● -	● -	● -	● -	● -	● -	○ -
DDR5, QRx4, 2x, 1DPC	● -	● -	● -	● -	● -	● -	● -	○ -
DDR5, DRx8, 2x, 2DPC	● -	● -	● -	● -	● -	● -	● -	○ -
DDR5, DRx4, 2x, 2DPC	● -	● -	● -	● -	● -	● -	● -	○ -
DDR5, QRx4, 2x, 2DPC	● -	● -	● -	● -	● -	● -	● -	○ -

Intel® Server System M50FCP2UR Technical Product Specification

<b>PCI Card Cooling</b>	<b>Supported Thermal Level</b>							
Riser 1 slot 1	LEVEL7 / -	LEVEL7 / -	LEVEL7 / -	LEVEL7 / -	LEVEL7 / -	LEVEL7 / -	LEVEL7 / -	LEVEL6 / -
Riser 1 slot 2	LEVEL7 / -	LEVEL7 / -	LEVEL7 / -	LEVEL7 / -	LEVEL7 / -	LEVEL6 / -	LEVEL6 / -	LEVEL5 / -
Riser 1 slot 3	LEVEL7 / -	LEVEL7 / -	LEVEL7 / -	LEVEL7 / -	LEVEL7 / -	LEVEL6 / -	LEVEL6 / -	LEVEL5 / -
Riser 2 slot 1	N/A	N/A	N/A	N/A	N/A	N/A	N/A	N/A
Riser 2 slot 2	N/A	N/A	N/A	N/A	N/A	N/A	N/A	N/A
Riser 2 slot 3	N/A	N/A	N/A	N/A	N/A	N/A	N/A	N/A
Riser 3 slot 1	N/A	N/A	N/A	N/A	N/A	N/A	N/A	N/A
Riser 3 slot 2	N/A	N/A	N/A	N/A	N/A	N/A	N/A	N/A
<b>3.5" SAS/SATA SSD</b>	<b>3.5" SAS/SATA SSD Support</b>							
Rated to 60C	-	-	-	-	-	-	-	-
<b>2.5" PCIe NVMe SSD</b>	<b>2.5" PCIe NVMe SSD Support</b>							
NVMe TDP = 25W, Rated to 70C	● -	● -	● -	● -	● -	● -	● -	-
<b>GPGPU card type</b>	<b>GPGPU card Support</b>							
Nvidia DW GPGPU - A16/A30/A40/A100-40G/A100-80G/H100	● -	● -	● -	● -	-	-	-	-
Intel® FPGA PAC D5005 - DW - 225W	● -	● -	● -	● -	● -	● -	-	-
PonteVecchio - DW - 300W	● -	● -	● -	● -	-	-	-	-
Intel ATS M1 - FH, 3/4 Length, Single Slot - 150W	● -	● -	● -	● -	● -	● -	-	-
Nvidia Tesla A2 - LP- 60W	● -	● -	● -	-	-	-	-	-
Intel ATS M3 - LP- 75W	● -	● -	● -	● -	● -	● -	-	-
<b>Rear SSD above PSUs</b>	<b>Rear SSD Support</b>							
SATA SSD, Rated to 70C	● -	● -	● -	● -	● -	● -	● -	● -
<b>M.2 SSD</b>	<b>M.2 NVMe SSD Support</b>							

Intel® Server System M50FCP2UR Technical Product Specification

Micron 7400/7450 series (rated to 70C, TDP = 8W)	● -	● -	● -	● -	-	-	-	-
Other NVMe/SATA SSD in APlist (rated to 70C)	● -	● -	● -	● -	● -	● -	● -	-
<b>PSU</b>	<b>PSU Support (CPU power: 205W)</b>							
2100W	● -	● -	● -	● -	● -	● -	● -	● -
1600W	● -	● -	● -	● -	● -	● -	● -	● -
1300W	● -	● -	● -	● -	● -	● -	● -	● -
<b>OCP V3</b>	<b>OCP V3 Support</b>							
OCP 25W w/ class-2 QSFP	● -	● -	● -	● -	● -	● -	● -	● -
<b>Battery Backup</b>	<b>Battery Backup Support</b>							
BBU inlet (rated to 45C)	● -	● -	● -	● -	● -	● -	-	-

**Table 73. Thermal Configuration Matrix with Single 5<sup>th</sup> Gen Processors Installed Normal Operating Mode (Table 3 of 4) (M50FCP2UR x16 Drive with 2U Heat Sink)**

Intel® Server M50FCPR2UR208x16, 2U Heatsink, 1 Socket, Air-cooled								
Max Ambient Temperature	15°C	20°C	25°C	27°C	32°C	35°C	40°C	45°C
<b>CPU SKU</b>	<b>CPU Support (TDP 350W)</b>							
Intel® Xeon® Platinum 8592+, 350W, 64C	● -	● -	● -	● -	● -	● -	● -	-
Intel® Xeon® Platinum 8580, 350W, 60C	● -	● -	● -	● -	● -	● -	● -	-
Intel® Xeon® Platinum 8570, 350W, 56C	● -	● -	● -	● -	● -	● -	● -	-
Intel® Xeon® Platinum 8558P, 350W, 48C	● -	● -	● -	● -	● -	● -	● -	-
Intel® Xeon® Platinum 8568Y+, 350W, 48C	● -	● -	● -	● -	● -	● -	● -	-
Intel® Xeon® Platinum 8592V, 330W, 64C	● -	● -	● -	● -	● -	● -	● -	-
Intel® Xeon® Platinum 8558, 330W, 48C	● -	● -	● -	● -	● -	● -	● -	-
Intel® Xeon® Platinum 8571N, 300W, 52C	● -	● -	● -	● -	● -	● -	● -	-
Intel® Xeon® Platinum 8558U, 300W, 48C	● -	● -	● -	● -	● -	● -	● -	-

Intel® Server System M50FCP2UR Technical Product Specification

Intel® Xeon® Platinum 8581V, 270W, 60C	● -	● -	● -	● -	● -	● -	● -	○ -
Intel® Xeon® Gold 6554S, 270W, 36C	● -	● -	● -	● -	● -	● -	○ -	○ -
Intel® Xeon® Gold 6530, 270W, 32C	● -	● -	● -	● -	● -	● -	● -	○ -
Intel® Xeon® Platinum 8562Y+, 300W, 32C	● -	● -	● -	● -	● -	● -	● -	-
Intel® Xeon® Gold 6544Y, 270W, 16C	● -	● -	● -	● -	● -	● -	○ -	○ -
Intel® Xeon® Gold 6548Y+, 250W, 32C	● -	● -	● -	● -	● -	● -	● -	● -
Intel® Xeon® Gold 6548N, 250W, 32C	● -	● -	● -	● -	● -	● -	● -	● -
Intel® Xeon® Gold 6542Y, 250W, 24C	● -	● -	● -	● -	● -	● -	● -	● -
Intel® Xeon® Gold 6538Y+, 225W, 32C	● -	● -	● -	● -	● -	● -	● -	● -
Intel® Xeon® Gold 6538N, 205W, 32C	● -	● -	● -	● -	● -	● -	● -	● -
Intel® Xeon® Gold 5520+, 205W, 28C	● -	● -	● -	● -	● -	● -	● -	● -
Intel® Xeon® Gold 6526Y, 195W, 16C	● -	● -	● -	● -	● -	● -	● -	● -
Intel® Xeon® Gold 6534, 195W, 8C	● -	● -	● -	● -	● -	● -	○ -	-
Intel® Xeon® Gold 5512U, 185W, 28C	● -	● -	● -	● -	● -	● -	● -	● -
Intel® Xeon® Silver 4516Y+, 185W, 24C	● -	● -	● -	● -	● -	● -	● -	● -
Intel® Xeon® Gold 5515+, 165W, 8C	● -	● -	● -	● -	● -	● -	● -	● -
Intel® Xeon® Gold 4514Y, 150W, 16C	● -	● -	● -	● -	● -	● -	● -	● -
Intel® Xeon® Silver 4510, 150W, 12C	● -	● -	● -	● -	● -	● -	● -	● -
<b>Memory Type</b>	<b>Memory Support</b>							
DDR5, DRx8, 1x, 1DPC	● -	● -	● -	● -	● -	● -	○ -	○ -
DDR5, DRx4, 1x, 1DPC	● -	● -	● -	● -	● -	● -	○ -	○ -
DDR5, QRx4, 1x, 1DPC	● -	● -	● -	● -	● -	● -	○ -	○ -
DDR5, DRx8, 1x, 2DPC	● -	● -	● -	● -	● -	● -	○ -	○ -
DDR5, DRx4, 1x, 2DPC	● -	● -	● -	● -	● -	● -	○ -	○ -
DDR5, QRx4, 1x, 2DPC	● -	● -	● -	● -	● -	● -	○ -	○ -
DDR5, DRx8, 2x, 1DPC	● -	● -	● -	● -	● -	● -	○ -	○ -

Intel® Server System M50FCP2UR Technical Product Specification

DDR5, DRx4, 2x, 1DPC	● -	● -	● -	● -	● -	● -	○ -	○ -
DDR5, QRx4, 2x, 1DPC	● -	● -	● -	● -	● -	● -	○ -	○ -
DDR5, DRx8, 2x, 2DPC	● -	● -	● -	● -	● -	● -	○ -	○ -
DDR5, DRx4, 2x, 2DPC	● -	● -	● -	● -	● -	● -	○ -	○ -
DDR5, QRx4, 2x, 2DPC	● -	● -	● -	● -	● -	● -	○ -	○ -
<b>PCI Card Cooling</b>	<b>Supported Thermal Level</b>							
Riser 1 slot 1	LEVEL7 / -	LEVEL7 / -	LEVEL7 / -	LEVEL7 / -	LEVEL7 / -	LEVEL7 / -	LEVEL6 / -	LEVEL6 / -
Riser 1 slot 2	LEVEL7 / -	LEVEL7 / -	LEVEL7 / -	LEVEL7 / -	LEVEL7 / -	LEVEL7 / -	LEVEL6 / -	LEVEL6 / -
Riser 1 slot 3	LEVEL7 / -	LEVEL7 / -	LEVEL7 / -	LEVEL7 / -	LEVEL7 / -	LEVEL6 / -	LEVEL6 / -	LEVEL5 / -
Riser 2 slot 1	N/A	N/A	N/A	N/A	N/A	N/A	N/A	N/A
Riser 2 slot 2	N/A	N/A	N/A	N/A	N/A	N/A	N/A	N/A
Riser 2 slot 3	N/A	N/A	N/A	N/A	N/A	N/A	N/A	N/A
Riser 3 slot 1	N/A	N/A	N/A	N/A	N/A	N/A	N/A	N/A
Riser 3 slot 2	N/A	N/A	N/A	N/A	N/A	N/A	N/A	N/A
<b>3.5" SAS/SATA SSD</b>	<b>3.5" SAS/SATA SSD Support</b>							
Rated to 60C	-	-	-	-	-	-	-	-
<b>2.5" PCIe NVMe SSD</b>	<b>2.5" PCIe NVMe SSD Support</b>							
NVMe TDP = 25W, Rated to 70C	● -	● -	● -	● -	● -	● -	● -	-
<b>GPGPU card type</b>	<b>GPGPU card Support</b>							
Nvidia DW GPGPU - A16/A30/A40/A100-40G/A100-80G/H100	-	-	-	-	-	-	-	-
Intel® FPGA PAC D5005 - DW - 225W	-	-	-	-	-	-	-	-
PonteVecchio - DW - 300W	-	-	-	-	-	-	-	-
Intel ATS M1 - FH, 3/4 Length, Single Slot - 150W	-	-	-	-	-	-	-	-
Nvidia Tesla A2 - LP- 60W	● -	● -	● -	-	-	-	-	-



Intel® Server System M50FCP2UR Technical Product Specification

Intel ATS M3 - LP- 75W	● -	● -	● -	● -	● -	-	-	-
<b>Rear SSD above PSUs</b>	<b>Rear SSD Support</b>							
SATA SSD, Rated to 70C	● -	● -	● -	● -	● -	● -	● -	● -
<b>M.2 SSD</b>	<b>M.2 NVMe SSD Support</b>							
Micron 7400/7450 series (rated to 70C, TDP = 8W)	● -	● -	● -	● -	-	-	-	-
Other NVMe/SATA SSD in APlist (rated to 70C)	● -	● -	● -	● -	● ●	● ●	● ○	● -
<b>PSU</b>	<b>PSU Support (Fan normal: 350W / Fan fail: 250W)</b>							
2100W	● -	● -	● -	● -	● -	● -	● -	-
1600W	● -	● -	● -	● -	● -	● -	● -	-
1300W	● -	● -	● -	● -	● -	● -	● -	-
<b>OCP V3</b>	<b>OCP V3 Support</b>							
OCP 25W w/ class-2 QSFP	● -	● -	● -	● -	● -	● -	● -	● -
<b>Battery Backup</b>	<b>Battery Backup Support</b>							
BBU inlet (rated to 45C)	● -	● -	● -	● -	● ○	● -	-	-

**Table 74. Thermal Configuration Matrix with Single 5<sup>th</sup> Gen Processors Installed Normal Operating Mode (Table 4 of 4 (M50FCP2UR x16 Drive with 1U Heat Sink)**

Intel® Server M50FCPR2UR208x16 , 1U Heatsink, 1 Socket, Air-cooled								
Max Ambient Temperature	15°C	20°C	25°C	27°C	32°C	35°C	40°C	45°C
<b>CPU SKU</b>	<b>CPU Support (TDP 205W)</b>							
Intel® Xeon® Gold 6538N, 205W, 32C	● -	● -	● -	● -	● -	● -	● -	○ -
Intel® Xeon® Gold 5520+, 205W, 28C	● -	● -	● -	● -	● -	● -	● -	○ -
Intel® Xeon® Gold 6526Y, 195W, 16C	● -	● -	● -	● -	● -	● -	● -	○ -
Intel® Xeon® Gold 6534, 195W, 8C	● -	● -	○ -	○ -	-	-	-	-

Intel® Server System M50FCP2UR Technical Product Specification

Intel® Xeon® Gold 5512U, 185W, 28C	● -	● -	● -	● -	● -	● -	● -	● -
Intel® Xeon® Gold 5515+, 165W, 8C	● -	● -	● -	● -	● -	● -	● -	○ -
Intel® Xeon® Silver 4516Y+, 185W, 24C	● -	● -	● -	● -	● -	● -	● -	○ -
Intel® Xeon® Gold 4514Y, 150W, 16C	● -	● -	● -	● -	● -	● -	● -	● -
Intel® Xeon® Silver 4510, 150W, 12C	● -	● -	● -	● -	● -	● -	● -	● -
<b>Memory Type</b>	<b>Memory Support</b>							
DDR5, DRx8, 1x, 1DPC	● -	● -	● -	● -	● -	● -	● -	○ -
DDR5, DRx4, 1x, 1DPC	● -	● -	● -	● -	● -	● -	● -	○ -
DDR5, QRx4, 1x, 1DPC	● -	● -	● -	● -	● -	● -	● -	○ -
DDR5, DRx8, 1x, 2DPC	● -	● -	● -	● -	● -	● -	● -	○ -
DDR5, DRx4, 1x, 2DPC	● -	● -	● -	● -	● -	● -	● -	○ -
DDR5, QRx4, 1x, 2DPC	● -	● -	● -	● -	● -	● -	● -	○ -
DDR5, DRx8, 2x, 1DPC	● -	● -	● -	● -	● -	● -	● -	○ -
DDR5, DRx4, 2x, 1DPC	● -	● -	● -	● -	● -	● -	● -	○ -
DDR5, QRx4, 2x, 1DPC	● -	● -	● -	● -	● -	● -	● -	○ -
DDR5, DRx8, 2x, 2DPC	● -	● -	● -	● -	● -	● -	● -	○ -
DDR5, DRx4, 2x, 2DPC	● -	● -	● -	● -	● -	● -	● -	○ -
DDR5, QRx4, 2x, 2DPC	● -	● -	● -	● -	● -	● -	● -	○ -
<b>PCI Card Cooling</b>	<b>Supported Thermal Level</b>							
Riser 1 slot 1	LEVEL7 /-	LEVEL7 /-	LEVEL7 /-	LEVEL7 /-	LEVEL7 /-	LEVEL7 /-	LEVEL7 /-	LEVEL6 /-
Riser 1 slot 2	LEVEL7 /-	LEVEL7 /-	LEVEL7 /-	LEVEL7 /-	LEVEL7 /-	LEVEL6 /-	LEVEL6 /-	LEVEL5 /-
Riser 1 slot 3	LEVEL7 /-	LEVEL7 /-	LEVEL7 /-	LEVEL7 /-	LEVEL7 /-	LEVEL6 /-	LEVEL6 /-	LEVEL5 /-
Riser 2 slot 1	N/A	N/A	N/A	N/A	N/A	N/A	N/A	N/A
Riser 2 slot 2	N/A	N/A	N/A	N/A	N/A	N/A	N/A	N/A
Riser 2 slot 3	N/A	N/A	N/A	N/A	N/A	N/A	N/A	N/A

Intel® Server System M50FCP2UR Technical Product Specification

Riser 3 slot 1	N/A	N/A	N/A	N/A	N/A	N/A	N/A	N/A
Riser 3 slot 2	N/A	N/A	N/A	N/A	N/A	N/A	N/A	N/A
<b>3.5" SAS/SATA SSD</b>	<b>3.5" SAS/SATA SSD Support</b>							
Rated to 60C	-	-	-	-	-	-	-	-
<b>2.5" PCIe NVMe SSD</b>	<b>2.5" PCIe NVMe SSD Support</b>							
NVMe TDP = 25W, Rated to 70C	●-	●-	●-	●-	●-	●-	●○	-
<b>GPGPU card type</b>	<b>GPGPU card Support</b>							
Nvidia DW GPGPU - A16/A30/A40/A100-40G/A100-80G/H100	●-	●-	●-	●-	-	-	-	-
Intel® FPGA PAC D5005 - DW - 225W	●-	●-	●-	●-	●-	●-	-	-
PonteVecchio - DW - 300W	●-	●-	●-	●-	-	-	-	-
Intel ATS M1 - FH, 3/4 Length, Single Slot - 150W	●-	●-	●-	●-	●-	●-	-	-
Nvidia Tesla A2 - LP- 60W	●-	●-	●-	-	-	-	-	-
Intel ATS M3 - LP- 75W	●-	●-	●-	●-	●-	●-	-	-
<b>Rear SSD above PSUs</b>	<b>Rear SSD Support</b>							
SATA SSD, Rated to 70C	●-	●-	●-	●-	●-	●-	●-	●-
<b>M.2 SSD</b>	<b>M.2 NVMe SSD Support</b>							
Micron 7400/7450 series (rated to 70C, TDP = 8W)	●-	●-	●-	●-	-	-	-	-
Other NVMe/SATA SSD in APlist (rated to 70C)	●-	●-	●-	●-	●-	●-	●-	-
<b>PSU</b>	<b>PSU Support (Fan normal: 205W / Fan fail : 185W)</b>							
2100W	●-	●-	●-	●-	●-	●-	●-	●-
1600W	●-	●-	●-	●-	●-	●-	●-	●-
1300W	●-	●-	●-	●-	●-	●-	●-	●-

<b>OCP V3</b>	<b>OCP V3 Support</b>							
OCP 25W w/ class-2 QSFP	● -	● -	● -	● -	● -	● -	● -	● -
<b>Battery Backup</b>	<b>Battery Backup Support</b>							
BBU inlet (rated to 45C)	● -	● -	● -	● -	● -	● -	-	-

**Table 75. Thermal Configuration Matrix with Single 4<sup>th</sup> Gen Processors Installed Normal Operating Mode (Table 1 of 4) (M50FCP2UR x8 Drive with 2U Heat Sink)**

Intel® Server M50FCPR2UR2208, 2U heatsink, 1 socket, Air-cooled								
Max Ambient Temperature	15°C	20°C	25°C	27°C	32°C	35°C	40°C	45°C
<b>CPU SKU</b>	<b>CPU Support (TDP 350W)</b>							
Intel® Xeon® Platinum 8490H, 350W, 60C	● -	● -	● -	● -	● -	● -	● -	○ -
Intel® Xeon® Platinum 8480+, 350W, 56C	● -	● -	● -	● -	● -	● -	● -	○ -
Intel® Xeon® Platinum 8470Q, 350W, 52C	● -	● -	○ -	○ -	-	-	-	-
Intel® Xeon® Platinum 8470, 350W, 52C	● -	● -	● -	● -	● -	● -	● -	○ -
Intel® Xeon® Platinum 8468, 350W, 48C	● -	● -	● -	● -	● -	● -	● -	○ -
Intel® Xeon® Platinum 8458P, 350W, 44C	● -	● -	● -	● -	● -	● -	● -	○ -
Intel® Xeon® Platinum 8468V, 330W, 48C	● -	● -	● -	● -	● -	● -	● -	○ -
Intel® Xeon® Platinum 8468H, 330W, 48C	● -	● -	● -	● -	● -	● -	● -	○ -
Intel® Xeon® Platinum 8460H, 330W, 40C	● -	● -	● -	● -	● -	● -	● -	○ -
Intel® Xeon® Platinum 8471N, 300W, 52C	● -	● -	● -	● -	● -	● -	● -	● -
Intel® Xeon® Platinum 8470N, 300W, 52C	● -	● -	● -	● -	● -	● -	● -	● -
Intel® Xeon® Platinum 8461V, 300W, 48C	● -	● -	● -	● -	● -	● -	● -	● -
Intel® Xeon® Platinum 8460Y+, 300W, 40C	● -	● -	● -	● -	● -	● -	● -	● -
Intel® Xeon® Platinum 8452Y, 300W, 36C	● -	● -	● -	● -	● -	● -	● -	● -
Intel® Xeon® Gold 6454S, 270W, 32C	● -	● -	● -	● -	● -	● -	● -	● -
Intel® Xeon® Platinum 8454H, 270W, 32C	● -	● -	● -	● -	● -	● -	● -	● -

Intel® Server System M50FCP2UR Technical Product Specification

Intel® Xeon® Gold 6430, 270W, 32C	● -	● -	● -	● -	● -	● -	● -	● -
Intel® Xeon® Platinum 8444H, 270W, 16C	● -	● -	● -	● -	● -	● -	● -	● -
Intel® Xeon® Gold 6414U, 250W, 32C	● -	● -	● -	● -	● -	● -	● -	● -
Intel® Xeon® Platinum 8450H, 250W, 28C	● -	● -	● -	● -	● -	● -	● -	● -
Intel® Xeon® Gold 6458Q, 350W, 32C	● -	● -	○ -	○ -	-	-	-	-
Intel® Xeon® Platinum 8462Y+, 300W, 32C	● -	● -	● -	● -	● -	● -	● -	○ -
Intel® Xeon® Gold 6444Y, 270W, 16C	● -	● -	● -	● -	● -	● -	● -	○ -
Intel® Xeon® Gold 6448H, 250W, 32C	● -	● -	● -	● -	● -	● -	● -	● -
Intel® Xeon® Gold 6448Y, 225W, 32C	● -	● -	● -	● -	● -	● -	● -	● -
Intel® Xeon® Gold 6442Y, 225W, 24C	● -	● -	● -	● -	● -	● -	● -	● -
Intel® Xeon® Gold 6438M, 205W, 32C	● -	● -	● -	● -	● -	● -	● -	● -
Intel® Xeon® Gold 6438N, 205W, 32C	● -	● -	● -	● -	● -	● -	● -	● -
Intel® Xeon® Gold 6438Y+, 205W, 32C	● -	● -	● -	● -	● -	● -	● -	● -
Intel® Xeon® Gold 5420+, 205W, 28C	● -	● -	● -	● -	● -	● -	● -	● -
Intel® Xeon® Gold 6434, 195W, 8C	● -	● -	● -	● -	● -	● -	● -	○ -
Intel® Xeon® Gold 6434H, 195W, 8C	● -	● -	● -	● -	● -	● -	● -	○ -
Intel® Xeon® Gold 6428N, 185W, 32C	● -	● -	● -	● -	● -	● -	● -	● -
Intel® Xeon® Gold 6421N, 185W, 32C	● -	● -	● -	● -	● -	● -	● -	● -
Intel® Xeon® Gold 5418Y, 185W, 24C	● -	● -	● -	● -	● -	● -	● -	● -
Intel® Xeon® Gold 6418H, 185W, 24C	● -	● -	● -	● -	● -	● -	● -	● -
Intel® Xeon® Gold 5412U, 185W, 24C	● -	● -	● -	● -	● -	● -	● -	● -
Intel® Xeon® Gold 6426Y, 185W, 16C	● -	● -	● -	● -	● -	● -	● -	● -
Intel® Xeon® Gold 5418N, 165W, 24C	● -	● -	● -	● -	● -	● -	● -	● -
Intel® Xeon® Gold 5411N, 165W, 24C	● -	● -	● -	● -	● -	● -	● -	● -
Intel® Xeon® Silver 4416+, 165W, 20C	● -	● -	● -	● -	● -	● -	● -	● -
Intel® Xeon® Gold 6416H, 165W, 18C	● -	● -	● -	● -	● -	● -	● -	● -

Intel® Server System M50FCP2UR Technical Product Specification

Intel® Xeon® Gold 5416S, 150W, 16C	● -	● -	● -	● -	● -	● -	● -	● -
Intel® Xeon® Silver 4410Y, 150W, 12C	● -	● -	● -	● -	● -	● -	● -	● -
Intel® Xeon® Gold 5415+, 150W, 8C	● -	● -	● -	● -	● -	● -	● -	● -
Intel® Xeon® Bronze 3408U, 125W, 8C	● -	● -	● -	● -	● -	● -	● -	● -
Intel® Xeon® Silver 4410T, 150W, 10C	● -	● -	● -	● -	● -	● -	● -	● -
<b>Memory Type</b>	<b>Memory Support</b>							
DDR5, DRx8, 1x, 1DPC	● -	● -	● -	● -	● -	● -	○ -	○ -
DDR5, DRx4, 1x, 1DPC	● -	● -	● -	● -	● -	● -	○ -	○ -
DDR5, QRx4, 1x, 1DPC	● -	● -	● -	● -	● -	● -	○ -	○ -
DDR5, DRx8, 1x, 2DPC	● -	● -	● -	● -	● -	● -	○ -	○ -
DDR5, DRx4, 1x, 2DPC	● -	● -	● -	● -	● -	● -	○ -	○ -
DDR5, QRx4, 1x, 2DPC	● -	● -	● -	● -	● -	● -	○ -	○ -
DDR5, DRx8, 2x, 1DPC	● -	● -	● -	● -	● -	● -	○ -	○ -
DDR5, DRx4, 2x, 1DPC	● -	● -	● -	● -	● -	● -	○ -	○ -
DDR5, QRx4, 2x, 1DPC	● -	● -	● -	● -	● -	● -	○ -	○ -
DDR5, DRx8, 2x, 2DPC	● -	● -	● -	● -	● -	● -	○ -	○ -
DDR5, DRx4, 2x, 2DPC	● -	● -	● -	● -	● -	● -	○ -	○ -
DDR5, QRx4, 2x, 2DPC	● -	● -	● -	● -	● -	● -	○ -	○ -
<b>PCI Card Cooling</b>	<b>Supported Thermal Level</b>							
Riser 1 slot 1	LEVEL7 / -	LEVEL7 / -	LEVEL7 / -	LEVEL7 / -	LEVEL7 / -	LEVEL7 / -	LEVEL6 / -	LEVEL6 / -
Riser 1 slot 2	LEVEL7 / -	LEVEL7 / -	LEVEL7 / -	LEVEL7 / -	LEVEL7 / -	LEVEL7 / -	LEVEL6 / -	LEVEL6 / -
Riser 1 slot 3	LEVEL7 / -	LEVEL7 / -	LEVEL7 / -	LEVEL7 / -	LEVEL7 / -	LEVEL6 / -	LEVEL6 / -	LEVEL5 / -
Riser 2 slot 1	N/A	N/A	N/A	N/A	N/A	N/A	N/A	N/A
Riser 2 slot 2	N/A	N/A	N/A	N/A	N/A	N/A	N/A	N/A
Riser 2 slot 3	N/A	N/A	N/A	N/A	N/A	N/A	N/A	N/A

Intel® Server System M50FCP2UR Technical Product Specification

Riser 3 slot 1	N/A	N/A	N/A	N/A	N/A	N/A	N/A	N/A
Riser 3 slot 2	N/A	N/A	N/A	N/A	N/A	N/A	N/A	N/A
<b>3.5" SAS/SATA SSD</b>	<b>3.5" SAS/SATA SSD Support</b>							
Rated to 60C	-	-	-	-	-	-	-	-
<b>2.5" PCIe NVMe SSD</b>	<b>2.5" PCIe NVMe SSD Support</b>							
NVMe TDP = 25W, Rated to 70C	●-	●-	●-	●-	●-	●-	-	-
<b>GPGPU card type</b>	<b>GPGPU card Support</b>							
Nvidia DW GPGPU - A16/A30/A40/A100-40G/A100-80G/H100	-	-	-	-	-	-	-	-
Intel® FPGA PAC D5005 - DW - 225W	-	-	-	-	-	-	-	-
PonteVecchio - DW - 300W	-	-	-	-	-	-	-	-
Intel ATS M1 - FH, 3/4 Length, Single Slot - 150W	-	-	-	-	-	-	-	-
Nvidia Tesla A2 - LP- 60W	●-	●-	●-	●-	-	-	-	-
Intel ATS M3 - LP- 75W	●-	●-	●-	●-	●-	-	-	-
<b>Rear SSD above PSUs</b>	<b>Rear SSD Support</b>							
SATA SSD, Rated to 70C	●-	●-	●-	●-	●-	●-	●-	●-
<b>M.2 SSD</b>	<b>M.2 NVMe SSD Support</b>							
Micron 7400/7450 series (rated to 70C, TDP = 8W)	●-	●-	●-	●-	●-	-	-	-
Other NVMe/SATA SSD in APlist (rated to 70C)	●-	●-	●-	●-	●-	●-	●-	●-
<b>PSU</b>	<b>PSU Support (CPU power: 350W)</b>							
2100W	●-	●-	●-	●-	●-	●-	●-	●-
1600W	●-	●-	●-	●-	●-	●-	●-	●-
1300W	●-	●-	●-	●-	●-	●-	●-	●-
<b>OCP V3</b>	<b>OCP V3 Support</b>							

OCP 25W w/ class-2 QSFP	● -	● -	● -	● -	● -	● -	● -	● -
<b>Battery Backup</b>	<b>Battery Backup Support</b>							
BBU inlet (rated to 45C)	● -	● -	● -	● -	● -	● -	● -	-

**Table 76. Thermal Configuration Matrix with Single 4<sup>th</sup> Gen Processors Installed Normal Operating Mode (Table 2 of 4) (M50FCP2UR x8 Drive with 1U Heat Sink)**

Intel® Server M50FCPR2UR2208, 1U Heatsink, 1 Socket, Air-cooled								
Max Ambient Temperature	15°C	20°C	25°C	27°C	32°C	35°C	40°C	45°C
<b>CPU SKU</b>	<b>CPU Support (TDP 205W)</b>							
Intel® Xeon® Gold 6438M, 205W, 32C	● -	● -	● -	● -	● -	● -	● -	○ -
Intel® Xeon® Gold 6438N, 205W, 32C	● -	● -	● -	● -	● -	● -	● -	○ -
Intel® Xeon® Gold 6438Y+, 205W, 32C	● -	● -	● -	● -	● -	● -	○ -	-
Intel® Xeon® Gold 5420+, 205W, 28C	● -	● -	● -	● -	● -	● -	● -	○ -
Intel® Xeon® Gold 6434, 195W, 8C	● -	● -	● -	● -	○ -	-	-	-
Intel® Xeon® Gold 6434H, 195W, 8C	● -	● -	● -	● -	○ -	-	-	-
Intel® Xeon® Gold 6428N, 185W, 32C	● -	● -	● -	● -	● -	● -	● -	● -
Intel® Xeon® Gold 6421N, 185W, 32C	● -	● -	● -	● -	● -	● -	● -	● -
Intel® Xeon® Gold 5418Y, 185W, 24C	● -	● -	● -	● -	● -	● -	● -	○ -
Intel® Xeon® Gold 6418H, 185W, 24C	● -	● -	● -	● -	● -	● -	● -	○ -
Intel® Xeon® Gold 5412U, 185W, 24C	● -	● -	● -	● -	● -	● -	● -	○ -
Intel® Xeon® Gold 6426Y, 185W, 16C	● -	● -	● -	● -	● -	● -	● -	○ -
Intel® Xeon® Gold 5418N, 165W, 24C	● -	● -	● -	● -	● -	● -	● -	● -
Intel® Xeon® Gold 5411N, 165W, 24C	● -	● -	● -	● -	● -	● -	● -	● -
Intel® Xeon® Silver 4416+, 165W, 20C	● -	● -	● -	● -	● -	● -	● -	● -
Intel® Xeon® Gold 6416H, 165W, 18C	● -	● -	● -	● -	● -	● -	● -	● -



Intel® Server System M50FCP2UR Technical Product Specification

Intel® Xeon® Gold 5416S, 150W, 16C	● -	● -	● -	● -	● -	● -	● -	● -
Intel® Xeon® Silver 4410Y, 150W, 12C	● -	● -	● -	● -	● -	● -	● -	● -
Intel® Xeon® Gold 5415+, 150W, 8C	● -	● -	● -	● -	● -	● -	● -	● -
Intel® Xeon® Bronze 3408U, 125W, 8C	● -	● -	● -	● -	● -	● -	● -	● -
Intel® Xeon® Silver 4410T, 150W, 10C	● -	● -	● -	● -	● -	● -	● -	● -
<b>Memory Type</b>	<b>Memory Support</b>							
DDR5, DRx8, 1x, 1DPC	● -	● -	● -	● -	● -	● -	● -	○ -
DDR5, DRx4, 1x, 1DPC	● -	● -	● -	● -	● -	● -	● -	○ -
DDR5, QRx4, 1x, 1DPC	● -	● -	● -	● -	● -	● -	● -	○ -
DDR5, DRx8, 1x, 2DPC	● -	● -	● -	● -	● -	● -	● -	○ -
DDR5, DRx4, 1x, 2DPC	● -	● -	● -	● -	● -	● -	● -	○ -
DDR5, QRx4, 1x, 2DPC	● -	● -	● -	● -	● -	● -	● -	○ -
DDR5, DRx8, 2x, 1DPC	● -	● -	● -	● -	● -	● -	● -	○ -
DDR5, DRx4, 2x, 1DPC	● -	● -	● -	● -	● -	● -	● -	○ -
DDR5, QRx4, 2x, 1DPC	● -	● -	● -	● -	● -	● -	● -	○ -
DDR5, DRx8, 2x, 2DPC	● -	● -	● -	● -	● -	● -	● -	○ -
DDR5, DRx4, 2x, 2DPC	● -	● -	● -	● -	● -	● -	● -	○ -
DDR5, QRx4, 2x, 2DPC	● -	● -	● -	● -	● -	● -	● -	○ -
<b>PCI Card Cooling</b>	<b>Supported Thermal Level</b>							
Riser 1 slot 1	LEVEL7 / -	LEVEL7 / -	LEVEL7 / -	LEVEL7 / -	LEVEL7 / -	LEVEL7 / -	LEVEL7 / -	LEVEL6 / -
Riser 1 slot 2	LEVEL7 / -	LEVEL7 / -	LEVEL7 / -	LEVEL7 / -	LEVEL7 / -	LEVEL7 / -	LEVEL6 / -	LEVEL6 / -
Riser 1 slot 3	LEVEL7 / -	LEVEL7 / -	LEVEL7 / -	LEVEL7 / -	LEVEL7 / -	LEVEL7 / -	LEVEL6 / -	LEVEL6 / -
Riser 2 slot 1	N/A	N/A	N/A	N/A	N/A	N/A	N/A	N/A
Riser 2 slot 2	N/A	N/A	N/A	N/A	N/A	N/A	N/A	N/A
Riser 2 slot 3	N/A	N/A	N/A	N/A	N/A	N/A	N/A	N/A

Intel® Server System M50FCP2UR Technical Product Specification

Riser 3 slot 1	N/A	N/A	N/A	N/A	N/A	N/A	N/A	N/A
Riser 3 slot 2	N/A	N/A	N/A	N/A	N/A	N/A	N/A	N/A
<b>3.5" SAS/SATA SSD</b>	<b>3.5" SAS/SATA SSD Support</b>							
Rated to 60C	-	-	-	-	-	-	-	-
<b>2.5" PCIe NVMe SSD</b>	<b>2.5" PCIe NVMe SSD Support</b>							
NVMe TDP = 25W, Rated to 70C	●-	●-	●-	●-	●-	●-	-	-
<b>GPGPU card type</b>	<b>GPGPU card Support</b>							
Nvidia DW GPGPU - A16/A30/A40/A100-40G/A100-80G/H100	●-	●-	●-	●-	-	-	-	-
Intel® FPGA PAC D5005 - DW - 225W	●-	●-	●-	●-	●-	●-	-	-
PonteVecchio - DW - 300W	●-	●-	●-	●-	●-	-	-	-
Intel ATS M1 - FH, 3/4 Length, Single Slot - 150W	●-	●-	●-	●-	●-	●-	-	-
Nvidia Tesla A2 - LP- 60W	●-	●-	●-	-	-	-	-	-
Intel ATS M3 - LP- 75W	●-	●-	●-	●-	●-	●-	-	-
<b>Rear SSD above PSUs</b>	<b>Rear SSD Support</b>							
SATA SSD, Rated to 70C	●-	●-	●-	●-	●-	●-	●-	●-
<b>M.2 SSD</b>	<b>M.2 NVMe SSD Support</b>							
Micron 7400/7450 series (rated to 70C, TDP = 8W)	●-	●-	●-	●-	●-	-	-	-
Other NVMe/SATA SSD in APlist (rated to 70C)	●-	●-	●-	●-	●-	●-	●-	●-
<b>PSU</b>	<b>PSU Support (Fan normal: 205W / Fan fail: 185W)</b>							
2100W	●-	●-	●-	●-	●-	●-	●-	●-
1600W	●-	●-	●-	●-	●-	●-	●-	●-
1300W	●-	●-	●-	●-	●-	●-	●-	●-
<b>OCP V3</b>	<b>OCP V3 Support</b>							

Intel® Server System M50FCP2UR Technical Product Specification

OCP 25W w/ class-2 QSFP	●-	●-	●-	●-	●-	●-	●-	●-
<b>Battery Backup</b>	<b>Battery Backup Support</b>							
BBU inlet (rated to 45C)	●-	●-	●-	●-	●-	●-	●-	-

**Table 77. Thermal Configuration Matrix with Single 5<sup>th</sup> Gen Processors Installed Normal Operating Mode (Table 3 of 4) (M50FCP2UR208 Drive with 2U Heat Sink)**

Intel® Server M50FCPR2UR208, 2U Heatsink, 1 Socket, Air-cooled								
Max Ambient Temperature	15°C	20°C	25°C	27°C	32°C	35°C	40°C	45°C
<b>CPU SKU</b>	<b>CPU Support (TDP 350W)</b>							
Intel® Xeon® Platinum 8592+, 350W, 64C	●-	●-	●-	●-	●-	●-	●-	○-
Intel® Xeon® Platinum 8580, 350W, 60C	●-	●-	●-	●-	●-	●-	●-	○-
Intel® Xeon® Platinum 8570, 350W, 56C	●-	●-	●-	●-	●-	●-	●-	○-
Intel® Xeon® Platinum 8558P, 350W, 48C	●-	●-	●-	●-	●-	●-	●-	○-
Intel® Xeon® Platinum 8568Y+, 350W, 48C	●-	●-	●-	●-	●-	●-	●-	●-
Intel® Xeon® Platinum 8592V, 330W, 64C	●-	●-	●-	●-	●-	●-	●-	○-
Intel® Xeon® Platinum 8558, 330W, 48C	●-	●-	●-	●-	●-	●-	●-	○-
Intel® Xeon® Platinum 8571N, 300W, 52C	●-	●-	●-	●-	●-	●-	●-	●-
Intel® Xeon® Platinum 8558U, 300W, 48C	●-	●-	●-	●-	●-	●-	●-	●-
Intel® Xeon® Platinum 8581V, 270W, 60C	●-	●-	●-	●-	●-	●-	●-	●-
Intel® Xeon® Gold 6554S, 270W, 36C	●-	●-	●-	●-	●-	●-	●-	●-
Intel® Xeon® Gold 6530, 270W, 32C	●-	●-	●-	●-	●-	●-	●-	●-
Intel® Xeon® Platinum 8562Y+, 300W, 32C	●-	●-	●-	●-	●-	●-	●-	○-
Intel® Xeon® Gold 6544Y, 270W, 16C	●-	●-	●-	●-	●-	●-	●-	○-
Intel® Xeon® Gold 6548Y+, 250W, 32C	●-	●-	●-	●-	●-	●-	●-	●-
Intel® Xeon® Gold 6548N, 250W, 32C	●-	●-	●-	●-	●-	●-	●-	●-
Intel® Xeon® Gold 6542Y, 250W, 24C	●-	●-	●-	●-	●-	●-	●-	●-

Intel® Server System M50FCP2UR Technical Product Specification

Intel® Xeon® Gold 6538Y+, 225W, 32C	● -	● -	● -	● -	● -	● -	● -	● -
Intel® Xeon® Gold 6538N, 205W, 32C	● -	● -	● -	● -	● -	● -	● -	● -
Intel® Xeon® Gold 5520+, 205W, 28C	● -	● -	● -	● -	● -	● -	● -	● -
Intel® Xeon® Gold 6526Y, 195W, 16C	● -	● -	● -	● -	● -	● -	● -	● -
Intel® Xeon® Gold 6534, 195W, 8C	● -	● -	● -	● -	● -	● -	● -	○ -
Intel® Xeon® Gold 5512U, 185W, 28C	● -	● -	● -	● -	● -	● -	● -	● -
Intel® Xeon® Silver 4516Y+, 185W, 24C	● -	● -	● -	● -	● -	● -	● -	● -
Intel® Xeon® Gold 5515+, 165W, 8C	● -	● -	● -	● -	● -	● -	● -	● -
Intel® Xeon® Gold 4514Y, 150W, 16C	● -	● -	● -	● -	● -	● -	● -	● -
Intel® Xeon® Silver 4510, 150W, 12C	● -	● -	● -	● -	● -	● -	● -	● -
<b>Memory Type</b>	<b>Memory Support</b>							
DDR5, DRx8, 1x, 1DPC	● -	● -	● -	● -	● -	● -	○ -	○ -
DDR5, DRx4, 1x, 1DPC	● -	● -	● -	● -	● -	● -	○ -	○ -
DDR5, QRx4, 1x, 1DPC	● -	● -	● -	● -	● -	● -	○ -	○ -
DDR5, DRx8, 1x, 2DPC	● -	● -	● -	● -	● -	● -	○ -	○ -
DDR5, DRx4, 1x, 2DPC	● -	● -	● -	● -	● -	● -	○ -	○ -
DDR5, QRx4, 1x, 2DPC	● -	● -	● -	● -	● -	● -	○ -	○ -
DDR5, DRx8, 2x, 1DPC	● -	● -	● -	● -	● -	● -	○ -	○ -
DDR5, DRx4, 2x, 1DPC	● -	● -	● -	● -	● -	● -	○ -	○ -
DDR5, QRx4, 2x, 1DPC	● -	● -	● -	● -	● -	● -	○ -	○ -
DDR5, DRx8, 2x, 2DPC	● -	● -	● -	● -	● -	● -	○ -	○ -
DDR5, DRx4, 2x, 2DPC	● -	● -	● -	● -	● -	● -	○ -	○ -
DDR5, QRx4, 2x, 2DPC	● -	● -	● -	● -	● -	● -	○ -	○ -
<b>PCI Card Cooling</b>	<b>Supported Thermal Level</b>							
Riser 1 slot 1	LEVEL7 / -	LEVEL7 / -	LEVEL7 / -	LEVEL7 / -	LEVEL7 / -	LEVEL7 / -	LEVEL6 / -	LEVEL6 / -

Intel® Server System M50FCP2UR Technical Product Specification

Riser 1 slot 2	LEVEL7 / -	LEVEL7 / -	LEVEL7 / -	LEVEL7 / -	LEVEL7 / -	LEVEL7 / -	LEVEL6 /-	LEVEL6 /-
Riser 1 slot 3	LEVEL7 / -	LEVEL7 / -	LEVEL7 / -	LEVEL7 / -	LEVEL7 / -	LEVEL7 / -	LEVEL6 /-	LEVEL5 / -
Riser 2 slot 1	N/A	N/A	N/A	N/A	N/A	N/A	N/A	N/A
Riser 2 slot 2	N/A	N/A	N/A	N/A	N/A	N/A	N/A	N/A
Riser 2 slot 3	N/A	N/A	N/A	N/A	N/A	N/A	N/A	N/A
Riser 3 slot 1	N/A	N/A	N/A	N/A	N/A	N/A	N/A	N/A
Riser 3 slot 2	N/A	N/A	N/A	N/A	N/A	N/A	N/A	N/A
<b>3.5" SAS/SATA SSD</b>	<b>3.5" SAS/SATA SSD Support</b>							
Rated to 60C	-	-	-	-	-	-	-	-
<b>2.5" PCIe NVMe SSD</b>	<b>2.5" PCIe NVMe SSD Support</b>							
NVMe TDP = 25W, Rated to 70C	● -	● -	● -	● -	● -	● -	-	-
<b>GPGPU card type</b>	<b>GPGPU card Support</b>							
Nvidia DW GPGPU - A16/A30/A40/A100-40G/A100-80G/H100	-	-	-	-	-	-	-	-
Intel® FPGA PAC D5005 - DW - 225W	-	-	-	-	-	-	-	-
PonteVecchio - DW - 300W	-	-	-	-	-	-	-	-
Intel ATS M1 - FH, 3/4 Length, Single Slot - 150W	-	-	-	-	-	-	-	-
Nvidia Tesla A2 - LP- 60W	● -	● -	● -	● -	-	-	-	-
Intel ATS M3 - LP- 75W	● -	● -	● -	● -	● -	-	-	-
<b>Rear SSD above PSUs</b>	<b>Rear SSD Support</b>							
SATA SSD, Rated to 70C	● -	● -	● -	● -	● -	● -	● -	● -
<b>M.2 SSD</b>	<b>M.2 NVMe SSD Support</b>							
Micron 7400/7450 series (rated to 70C, TDP = 8W)	● -	● -	● -	● -	● -	-	-	-
Other NVMe/SATA SSD in APlist (rated to 70C)	● -	● -	● -	● -	● -	● -	● -	● -

PSU	PSU Support (Fan normal: 350W / Fan fail: 330W)							
2100W	● -	● -	● -	● -	● -	● -	● -	● -
1600W	● -	● -	● -	● -	● -	● -	● -	● -
1300W	● -	● -	● -	● -	● -	● -	● -	● -
OCP V3	OCP V3 Support							
OCP 25W w/ class-2 QSFP	● -	● -	● -	● -	● -	● -	● -	● -
Battery Backup	Battery Backup Support							
BBU inlet (rated to 45C)	● -	● -	● -	● -	● -	● -	● -	-

**Table 78. Thermal Configuration Matrix with Single 5<sup>th</sup> Gen Processors Installed Normal Operating Mode (Table 4 of 4) (M50FCP2UR208 Drive with 1U Heat Sink)**

Intel® Server M50FCPR2UR2208, 1U Heatsink, 1 Socket, Air-cooled								
Max Ambient Temperature	15°C	20°C	25°C	27°C	32°C	35°C	40°C	45°C
CPU SKU	CPU Support (TDP 205W)							
Intel® Xeon® Gold 6538N, 205W, 32C	● -	● -	● -	● -	● -	● -	● -	○ -
Intel® Xeon® Gold 5520+, 205W, 28C	● -	● -	● -	● -	● -	● -	● -	○ -
Intel® Xeon® Gold 6526Y, 195W, 16C	● -	● -	● -	● -	● -	● -	● -	○ -
Intel® Xeon® Gold 6534, 195W, 8C	● -	● -	● -	● -	○ -	-	-	-
Intel® Xeon® Gold 5512U, 185W, 28C	● -	● -	● -	● -	● -	● -	● -	● -
Intel® Xeon® Silver 4516Y+, 185W, 24C	● -	● -	● -	● -	● -	● -	● -	○ -
Intel® Xeon® Gold 5515+, 165W, 8C	● -	● -	● -	● -	● -	● -	● -	○ -
Intel® Xeon® Gold 4514Y, 150W, 16C	● -	● -	● -	● -	● -	● -	● -	● -
Intel® Xeon® Silver 4510, 150W, 12C	● -	● -	● -	● -	● -	● -	● -	● -
Memory Type	Memory Support							
DDR5, DRx8, 1x, 1DPC	● -	● -	● -	● -	● -	● -	● -	○ -

Intel® Server System M50FCP2UR Technical Product Specification

DDR5, DRx4, 1x, 1DPC	● -	● -	● -	● -	● -	● -	● -	○ -
DDR5, QRx4, 1x, 1DPC	● -	● -	● -	● -	● -	● -	● -	○ -
DDR5, DRx8, 1x, 2DPC	● -	● -	● -	● -	● -	● -	● -	○ -
DDR5, DRx4, 1x, 2DPC	● -	● -	● -	● -	● -	● -	● -	○ -
DDR5, QRx4, 1x, 2DPC	● -	● -	● -	● -	● -	● -	● -	○ -
DDR5, DRx8, 2x, 1DPC	● -	● -	● -	● -	● -	● -	● -	○ -
DDR5, DRx4, 2x, 1DPC	● -	● -	● -	● -	● -	● -	● -	○ -
DDR5, QRx4, 2x, 1DPC	● -	● -	● -	● -	● -	● -	● -	○ -
DDR5, DRx8, 2x, 2DPC	● -	● -	● -	● -	● -	● -	● -	○ -
DDR5, DRx4, 2x, 2DPC	● -	● -	● -	● -	● -	● -	● -	○ -
DDR5, QRx4, 2x, 2DPC	● -	● -	● -	● -	● -	● -	● -	○ -
<b>PCI Card Cooling</b>	<b>Supported Thermal Level</b>							
Riser 1 slot 1	LEVEL7 / -	LEVEL7 / -	LEVEL7 / -	LEVEL7 / -	LEVEL7 / -	LEVEL7 / -	LEVEL7 / -	LEVEL6 / -
Riser 1 slot 2	LEVEL7 / -	LEVEL7 / -	LEVEL7 / -	LEVEL7 / -	LEVEL7 / -	LEVEL7 / -	LEVEL6 / -	LEVEL6 / -
Riser 1 slot 3	LEVEL7 / -	LEVEL7 / -	LEVEL7 / -	LEVEL7 / -	LEVEL7 / -	LEVEL7 / -	LEVEL6 / -	LEVEL6 / -
Riser 2 slot 1	N/A	N/A	N/A	N/A	N/A	N/A	N/A	N/A
Riser 2 slot 2	N/A	N/A	N/A	N/A	N/A	N/A	N/A	N/A
Riser 2 slot 3	N/A	N/A	N/A	N/A	N/A	N/A	N/A	N/A
Riser 3 slot 1	N/A	N/A	N/A	N/A	N/A	N/A	N/A	N/A
Riser 3 slot 2	N/A	N/A	N/A	N/A	N/A	N/A	N/A	N/A
<b>3.5" SAS/SATA SSD</b>	<b>3.5" SAS/SATA SSD Support</b>							
Rated to 60C	-	-	-	-	-	-	-	-
<b>2.5" PCIe NVMe SSD</b>	<b>2.5" PCIe NVMe SSD Support</b>							
NVMe TDP = 25W, Rated to 70C	● -	● -	● -	● -	● -	● -	-	-
<b>GPGPU card type</b>	<b>GPGPU card Support</b>							

Intel® Server System M50FCP2UR Technical Product Specification

Nvidia DW GPGPU - A16/A30/A40/A100-40G/A100-80G/H100	● -	● -	● -	● -	-	-	-	-
Intel® FPGA PAC D5005 - DW - 225W	● -	● -	● -	● -	● -	● -	-	-
PonteVecchio - DW - 300W	● -	● -	● -	● -	● -	-	-	-
Intel ATS M1 - FH, 3/4 Length, Single Slot - 150W	● -	● -	● -	● -	● -	● -	-	-
Nvidia Tesla A2 - LP- 60W	● -	● -	● -	-	-	-	-	-
Intel ATS M3 - LP- 75W	● -	● -	● -	● -	● -	● -	-	-
<b>Rear SSD above PSUs</b>	<b>Rear SSD Support</b>							
SATA SSD, Rated to 70C	● -	● -	● -	● -	● -	● -	● -	● -
<b>M.2 SSD</b>	<b>M.2 NVMe SSD Support</b>							
Micron 7400/7450 series (rated to 70C, TDP = 8W)	● -	● -	● -	● -	● -	-	-	-
Other NVMe/SATA SSD in APlist (rated to 70C)	● -	● -	● -	● -	● -	● -	● -	● -
<b>PSU</b>	<b>PSU Support (Fan normal: 205W / Fan fail: 185W)</b>							
2100W	● -	● -	● -	● -	● -	● -	● -	● -
1600W	● -	● -	● -	● -	● -	● -	● -	● -
1300W	● -	● -	● -	● -	● -	● -	● -	● -
<b>OCP V3</b>	<b>OCP V3 Support</b>							
OCP 25W w/ class-2 QSFP	● -	● -	● -	● -	● -	● -	● -	● -
<b>Battery Backup</b>	<b>Battery Backup Support</b>							
BBU inlet (rated to 45C)	● -	● -	● -	● -	● -	● -	● -	-



**Table 79. Thermal Configuration Matrix with Single Processors Installed Normal Operating Mode (Table 1 of 4) (M50FCP2UR312 with 2U Heat Sink)**

Intel® Server M50FCPR2UR2312, 2U Heatsink, 1 Socket, Air-cooled								
Max Ambient Temperature	15°C	20°C	25°C	27°C	32°C	35°C	40°C	45°C
<b>CPU SKU</b>	<b>CPU Support (TDP 205W)</b>							
Intel® Xeon® Gold 6448Y, 225W, 32C	● -	● -	● -	● -	● -	● -	○ -	-
Intel® Xeon® Gold 6442Y, 225W, 24C	● -	● -	● -	● -	● -	● -	○ -	-
Intel® Xeon® Gold 6438M, 205W, 32C	● -	● -	● -	● -	● -	● -	● -	-
Intel® Xeon® Gold 6438N, 205W, 32C	● -	● -	● -	● -	● -	● -	● -	-
Intel® Xeon® Gold 6438Y+, 205W, 32C	● -	● -	● -	● -	● -	● -	○ -	-
Intel® Xeon® Gold 5420+, 205W, 28C	● -	● -	● -	● -	● -	● -	● -	-
Intel® Xeon® Gold 6434, 195W, 8C	● -	● -	● -	● -	○ -	-	-	-
Intel® Xeon® Gold 6434H, 195W, 8C	● -	● -	● -	● -	○ -	-	-	-
Intel® Xeon® Gold 6428N, 185W, 32C	● -	● -	● -	● -	● -	● -	● -	-
Intel® Xeon® Gold 6421N, 185W, 32C	● -	● -	● -	● -	● -	● -	● -	-
Intel® Xeon® Gold 5418Y, 185W, 24C	● -	● -	● -	● -	● -	● -	● -	-
Intel® Xeon® Gold 6418H, 185W, 24C	● -	● -	● -	● -	● -	● -	● -	-
Intel® Xeon® Gold 5412U, 185W, 24C	● -	● -	● -	● -	● -	● -	● -	-
Intel® Xeon® Gold 6426Y, 185W, 16C	● -	● -	● -	● -	● -	● -	● -	-
Intel® Xeon® Gold 5418N, 165W, 24C	● -	● -	● -	● -	● -	● -	● -	● -
Intel® Xeon® Gold 5411N, 165W, 24C	● -	● -	● -	● -	● -	● -	● -	● -
Intel® Xeon® Silver 4416+, 165W, 20C	● -	● -	● -	● -	● -	● -	● -	● -
Intel® Xeon® Gold 6416H, 165W, 18C	● -	● -	● -	● -	● -	● -	● -	● -
Intel® Xeon® Gold 5416S, 150W, 16C	● -	● -	● -	● -	● -	● -	● -	● -

Intel® Server System M50FCP2UR Technical Product Specification

Intel® Xeon® Silver 4410Y, 150W, 12C	● -	● -	● -	● -	● -	● -	● -	● -
Intel® Xeon® Gold 5415+, 150W, 8C	● -	● -	● -	● -	● -	● -	● -	● -
Intel® Xeon® Bronze 3408U, 125W, 8C	● -	● -	● -	● -	● -	● -	● -	● -
Intel® Xeon® Silver 4410T, 150W, 10C	● -	● -	● -	● -	● -	● -	● -	● -
<b>Memory Type</b>	<b>Memory Support</b>							
DDR5, DRx8, 1x, 1DPC	● -	● -	● -	● -	● -	● -	● -	○ -
DDR5, DRx4, 1x, 1DPC	● -	● -	● -	○ -	○ -	-	-	-
DDR5, QRx4, 1x, 1DPC	● -	○ -	○ -	-	-	-	-	-
DDR5, DRx8, 1x, 2DPC	● -	● -	● -	● -	● -	● -	● -	● -
DDR5, DRx4, 1x, 2DPC	● -	● -	● -	● -	● -	● -	● -	● -
DDR5, QRx4, 1x, 2DPC	● -	● -	● -	● -	● -	● -	○ -	-
DDR5, DRx8, 2x, 1DPC	● -	● -	● -	● -	● -	● -	● -	● -
DDR5, DRx4, 2x, 1DPC	● -	● -	● -	● -	● -	● -	○ -	-
DDR5, QRx4, 2x, 1DPC	● -	● -	● -	○ -	○ -	-	-	-
DDR5, DRx8, 2x, 2DPC	● -	● -	● -	● -	● -	● -	● -	● -
DDR5, DRx4, 2x, 2DPC	● -	● -	● -	● -	● -	● -	● -	● -
DDR5, QRx4, 2x, 2DPC	● -	● -	● -	● -	● -	● -	● -	● -
<b>PCI Card Cooling</b>	<b>Supported Thermal Level</b>							
Riser 1 slot 1	LEVEL6 / -	LEVEL6 / -	LEVEL5 / -	LEVEL5 / -	LEVEL5 / -	LEVEL5 / -	LEVEL5 / -	LEVEL3 / -
Riser 1 slot 2	LEVEL6 / -	LEVEL5 / -	LEVEL5 / -	LEVEL5 / -	LEVEL4 / -	LEVEL4 / -	LEVEL3 / -	LEVEL2 / -
Riser 1 slot 3	LEVEL6 / -	LEVEL6 / -	LEVEL5 / -	LEVEL5 / -	LEVEL5 / -	LEVEL4 / -	LEVEL3 / -	LEVEL3 / -
Riser 2 slot 1	N/A	N/A	N/A	N/A	N/A	N/A	N/A	N/A
Riser 2 slot 2	N/A	N/A	N/A	N/A	N/A	N/A	N/A	N/A
Riser 2 slot 3	N/A	N/A	N/A	N/A	N/A	N/A	N/A	N/A
Riser 3 slot 1	N/A	N/A	N/A	N/A	N/A	N/A	N/A	N/A
Riser 3 slot 2	N/A	N/A	N/A	N/A	N/A	N/A	N/A	N/A

Intel® Server System M50FCP2UR Technical Product Specification

<b>3.5" SAS/SATA SSD</b>	<b>3.5" SAS/SATA SSD Support</b>							
Rated to 60C	● -	● -	● -	● -	● -	● -	● -	● -
<b>2.5" PCIe NVMe SSD</b>	<b>2.5" PCIe NVMe SSD Support</b>							
NVMe TDP = 25W, Rated to 70C	● -	● -	● -	● -	● -	● -	● -	● -
<b>GPGPU card type</b>	<b>GPGPU card Support</b>							
Nvidia DW GPGPU - A16/A30/A40/A100-40G/A100-80G/H100	-	-	-	-	-	-	-	-
Intel® FPGA PAC D5005 - DW - 225W	-	-	-	-	-	-	-	-
PonteVecchio - DW - 300W	-	-	-	-	-	-	-	-
Intel ATS M1 - FH, 3/4 Length, Single Slot - 150W	-	-	-	-	-	-	-	-
Nvidia Tesla A2 - LP- 60W	-	-	-	-	-	-	-	-
Intel ATS M3 - LP- 75W	-	-	-	-	-	-	-	-
<b>Rear SSD above PSUs</b>	<b>Rear SSD Support</b>							
SATA SSD, Rated to 70C	● -	● -	● -	● -	● -	● -	● -	-
<b>M.2 SSD</b>	<b>M.2 NVMe SSD Support</b>							
Micron 7400/7450 series (rated to 70C, TDP = 8W)	● -	● -	● -	-	-	-	-	-
Other NVMe/SATA SSD in APlist (rated to 70C)	● -	● -	● -	● -	● -	● -	-	-
<b>PSU</b>	<b>PSU Support (CPU power: 225W)</b>							
2100W	● -	● -	● -	● -	● -	● -	● -	-
1600W	● -	● -	● -	● -	● -	● -	● -	-
1300W	● -	● -	● -	● -	● -	● -	● -	-
<b>OCP V3</b>	<b>OCP V3 Support</b>							
OCP 25W w/ class-2 QSFP	● -	● -	● -	● -	● -	● -	● -	-

Battery Backup	Battery Backup Support							
BBU inlet (rated to 45C)	● -	● -	● -	● -	● -	● -	-	-

**Table 80. Thermal Configuration Matrix with Single 4<sup>th</sup> Gen Processors Installed Normal Operating Mode (Table 2 of 4) (M50FCP2UR312 with 1U Heat Sink)**

Intel® Server M50FCPR2UR2312, 1U Heatsink, 1 Socket, Air-cooled								
Max Ambient Temperature	15°C	20°C	25°C	27°C	32°C	35°C	40°C	45°C
<b>CPU SKU</b>	<b>CPU Support (TDP 185W)</b>							
Intel® Xeon® Gold 6428N, 185W, 32C	● -	● -	● -	● -	○ -	○ -	-	-
Intel® Xeon® Gold 6421N, 185W, 32C	● -	● -	● -	● -	○ -	○ -	-	-
Intel® Xeon® Gold 5418Y, 185W, 24C	● -	● -	● -	● -	○ -	-	-	-
Intel® Xeon® Gold 6418H, 185W, 24C	● -	● -	● -	● -	○ -	-	-	-
Intel® Xeon® Gold 5412U, 185W, 24C	● -	● -	● -	● -	○ -	-	-	-
Intel® Xeon® Gold 6426Y, 185W, 16C	● -	● -	● -	● -	○ -	-	-	-
Intel® Xeon® Gold 5418N, 165W, 24C	● -	● -	● -	● -	● -	● -	○ -	-
Intel® Xeon® Gold 5411N, 165W, 24C	● -	● -	● -	● -	● -	● -	○ -	-
Intel® Xeon® Silver 4416+, 165W, 20C	● -	● -	● -	● -	● -	○ -	○ -	-
Intel® Xeon® Gold 6416H, 165W, 18C	● -	● -	● -	● -	● -	○ -	○ -	-
Intel® Xeon® Gold 5416S, 150W, 16C	● -	● -	● -	● -	● -	● -	○ -	-
Intel® Xeon® Silver 4410Y, 150W, 12C	● -	● -	● -	● -	● -	○ -	○ -	-
Intel® Xeon® Gold 5415+, 150W, 8C	● -	● -	● -	● -	● -	○ -	○ -	-
Intel® Xeon® Bronze 3408U, 125W, 8C	● -	● -	● -	● -	● -	● -	● -	○ -
Intel® Xeon® Silver 4410T, 150W, 10C	● -	● -	● -	● -	● -	● -	● -	○ -
<b>Memory Type</b>	<b>Memory Support</b>							
DDR5, DRx8, 1x, 1DPC	● -	● -	● -	● -	● -	● -	● -	● -
DDR5, DRx4, 1x, 1DPC	● -	● -	● -	● -	● -	● -	○ -	-

Intel® Server System M50FCP2UR Technical Product Specification

DDR5, QRx4, 1x, 1DPC	● -	● -	● -	● -	○ -	○ -	-	-
DDR5, DRx8, 1x, 2DPC	● -	● -	● -	● -	● -	● -	● -	● -
DDR5, DRx4, 1x, 2DPC	● -	● -	● -	● -	● -	● -	● -	● -
DDR5, QRx4, 1x, 2DPC	● -	● -	● -	● -	● -	● -	● -	● -
DDR5, DRx8, 2x, 1DPC	● -	● -	● -	● -	● -	● -	● -	● -
DDR5, DRx4, 2x, 1DPC	● -	● -	● -	● -	● -	● -	● -	● -
DDR5, QRx4, 2x, 1DPC	● -	● -	● -	● -	● -	● -	○ -	-
DDR5, DRx8, 2x, 2DPC	● -	● -	● -	● -	● -	● -	● -	● -
DDR5, DRx4, 2x, 2DPC	● -	● -	● -	● -	● -	● -	● -	● -
DDR5, QRx4, 2x, 2DPC	● -	● -	● -	● -	● -	● -	● -	● -
<b>PCI Card Cooling</b>	<b>Supported Thermal Level</b>							
Riser 1 slot 1	LEVEL6 / -	LEVEL6 / -	LEVEL6 / -	LEVEL6 / -	LEVEL6 / -	LEVEL5 / -	LEVEL5 / -	LEVEL3 / -
Riser 1 slot 2	LEVEL7 / -	LEVEL6 / -	LEVEL6 / -	LEVEL6 / -	LEVEL6 / -	LEVEL6 / -	LEVEL4 / -	LEVEL3 / -
Riser 1 slot 3	LEVEL7 / -	LEVEL7 / -	LEVEL6 / -	LEVEL6 / -	LEVEL6 / -	LEVEL5 / -	LEVEL4 / -	LEVEL4 / -
Riser 2 slot 1	N/A	N/A	N/A	N/A	N/A	N/A	N/A	N/A
Riser 2 slot 2	N/A	N/A	N/A	N/A	N/A	N/A	N/A	N/A
Riser 2 slot 3	N/A	N/A	N/A	N/A	N/A	N/A	N/A	N/A
Riser 3 slot 1	N/A	N/A	N/A	N/A	N/A	N/A	N/A	N/A
Riser 3 slot 2	N/A	N/A	N/A	N/A	N/A	N/A	N/A	N/A
<b>3.5" SAS/SATA SSD</b>	<b>3.5" SAS/SATA SSD Support</b>							
Rated to 60C	● -	● -	● -	● -	● -	● -	● -	● -
<b>2.5" PCIe NVMe SSD</b>	<b>2.5" PCIe NVMe SSD Support</b>							
NVMe TDP = 25W, Rated to 70C	● -	● -	● -	● -	● -	● -	● -	● -
<b>GPGPU card type</b>	<b>GPGPU card Support</b>							
Nvidia DW GPGPU - A16/A30/A40/A100-40G/A100-80G/H100	-	-	-	-	-	-	-	-

Intel® Server System M50FCP2UR Technical Product Specification

Intel® FPGA PAC D5005 - DW - 225W	-	-	-	-	-	-	-	-
PonteVecchio - DW - 300W	-	-	-	-	-	-	-	-
Intel ATS M1 - FH, 3/4 Length, Single Slot - 150W	-	-	-	-	-	-	-	-
Nvidia Tesla A2 - LP- 60W	-	-	-	-	-	-	-	-
Intel ATS M3 - LP- 75W	-	-	-	-	-	-	-	-
<b>Rear SSD above PSUs</b>	<b>Rear SSD Support</b>							
SATA SSD, Rated to 70C	●-	●-	●-	●-	●-	●-	●-	-
<b>M.2 SSD</b>	<b>M.2 NVMe SSD Support</b>							
Micron 7400/7450 series (rated to 70C, TDP = 8W)	●-	●-	●-	-	-	-	-	-
Other NVMe/SATA SSD in APlist (rated to 70C)	●-	●-	●-	●-	●-	●-	-	-
<b>PSU</b>	<b>PSU Support (CPU power: 185W)</b>							
2100W	●-	●-	●-	●-	●-	●-	●-	-
1600W	●-	●-	●-	●-	●-	●-	●-	-
1300W	●-	●-	●-	●-	●-	●-	●-	-
<b>OCP V3</b>	<b>OCP V3 Support</b>							
OCP 25W w/ class-2 QSFP	●-	●-	●-	●-	●-	●-	●-	-
<b>Battery Backup</b>	<b>Battery Backup Support</b>							
BBU inlet (rated to 45C)	●-	●-	●-	●-	●-	●-	-	-

**Table 81. Thermal Configuration Matrix with Single 5<sup>th</sup> Gen Processors Installed Normal Operating Mode (Table 3 of 4) (M50FCP2UR312 with 2U Heat Sink)**

Intel® Server M50FCPR2UR2312, 2U Heatsink, 1 Socket , Air-cooled								
Max Ambient Temperature	15°C	20°C	25°C	27°C	32°C	35°C	40°C	45°C
<b>CPU SKU</b>	<b>CPU Support (TDP 205W)</b>							

Intel® Server System M50FCP2UR Technical Product Specification

Intel® Xeon® Gold 6538N, 205W, 32C	● -	● -	● -	● -	● -	● -	● -	-
Intel® Xeon® Gold 5520+, 205W, 28C	● -	● -	● -	● -	● -	● -	● -	-
Intel® Xeon® Gold 6526Y, 195W, 16C	● -	● -	● -	● -	● -	● -	● -	-
Intel® Xeon® Gold 6534, 195W, 8C	● -	● -	● -	○ -	○ -	-	-	-
Intel® Xeon® Gold 5512U, 185W, 28C	● -	● -	● -	● -	● -	● -	● -	-
Intel® Xeon® Gold 5515+, 165W, 8C	● -	● -	● -	● -	● -	● -	● -	○ -
Intel® Xeon® Silver 4516Y+, 185W, 24C	● -	● -	● -	● -	● -	● -	● -	-
Intel® Xeon® Gold 4514Y, 150W, 16C	● -	● -	● -	● -	● -	● ○	● -	● -
Intel® Xeon® Silver 4510, 150W, 12C	● -	● -	● -	● -	● -	● -	● -	● -
<b>Memory Type</b>	<b>Memory Support</b>							
DDR5, DRx8, 1x, 1DPC	● -	● -	● -	● -	● -	● -	● -	○ -
DDR5, DRx4, 1x, 1DPC	● -	● -	● -	○ -	○ -	-	-	-
DDR5, QRx4, 1x, 1DPC	● -	○ -	○ -	-	-	-	-	-
DDR5, DRx8, 1x, 2DPC	● -	● -	● -	● -	● -	● -	● -	● -
DDR5, DRx4, 1x, 2DPC	● -	● -	● -	● -	● -	● -	● -	● ○
DDR5, QRx4, 1x, 2DPC	● -	● -	● -	● -	● -	● -	○ -	-
DDR5, DRx8, 2x, 1DPC	● -	● -	● -	● -	● -	● -	● -	-●●
DDR5, DRx4, 2x, 1DPC	● -	● -	● -	● -	● -	● -	○ -	-
DDR5, QRx4, 2x, 1DPC	● -	● -	● -	○ -	○ -	-	-	-
DDR5, DRx8, 2x, 2DPC	● -	● -	● -	● -	● -	● -	● -	● -
DDR5, DRx4, 2x, 2DPC	● -	● -	● -	● -	● -	● -	● -	● -
DDR5, QRx4, 2x, 2DPC	● -	● -	● -	● -	● -	● -	● -	● -
<b>PCI Card Cooling</b>	<b>Supported Thermal Level</b>							
Riser 1 slot 1	LEVEL6 / -	LEVEL6 / -	LEVEL5 / -	LEVEL5 / -	LEVEL5 / -	LEVEL5 / -	LEVEL5 / -	LEVEL3 / -
Riser 1 slot 2	LEVEL6 / -	LEVEL5 / -	LEVEL5 / -	LEVEL5 / -	LEVEL4 / -	LEVEL4 / -	LEVEL3 / -	LEVEL2 / -

Intel® Server System M50FCP2UR Technical Product Specification

Riser 1 slot 3	LEVEL6 / -	LEVEL6 / -	LEVEL5 / -	LEVEL5 / -	LEVEL5 / -	LEVEL4 / -	LEVEL3 / -	LEVEL2 / -
Riser 2 slot 1	N/A	N/A	N/A	N/A	N/A	N/A	N/A	N/A
Riser 2 slot 2	N/A	N/A	N/A	N/A	N/A	N/A	N/A	N/A
Riser 2 slot 3	N/A	N/A	N/A	N/A	N/A	N/A	N/A	N/A
Riser 3 slot 1	N/A	N/A	N/A	N/A	N/A	N/A	N/A	N/A
Riser 3 slot 2	N/A	N/A	N/A	N/A	N/A	N/A	N/A	N/A
<b>3.5" SAS/SATA SSD</b>	<b>3.5" SAS/SATA SSD Support</b>							
Rated to 60C	● -	● -	● -	● -	● -	● -	● -	● -
<b>2.5" PCIe NVMe SSD</b>	<b>2.5" PCIe NVMe SSD Support</b>							
NVMe TDP = 25W, Rated to 70C	● -	● -	● -	● -	● -	● -	● -	● -
<b>GPGPU card type</b>	<b>GPGPU card Support</b>							
Nvidia DW GPGPU - A16/A30/A40/A100-40G/A100-80G/H100	-	-	-	-	-	-	-	-
Intel® FPGA PAC D5005 - DW - 225W	-	-	-	-	-	-	-	-
PonteVecchio - DW - 300W	-	-	-	-	-	-	-	-
Intel ATS M1 - FH, 3/4 Length, Single Slot - 150W	-	-	-	-	-	-	-	-
Nvidia Tesla A2 - LP- 60W	-	-	-	-	-	-	-	-
Intel ATS M3 - LP- 75W	-	-	-	-	-	-	-	-
<b>Rear SSD above PSUs</b>	<b>Rear SSD Support</b>							
SATA SSD, Rated to 70C	● -	● -	● -	● -	● -	● -	● -	-
<b>M.2 SSD</b>	<b>M.2 NVMe SSD Support</b>							
Micron 7400/7450 series (rated to 70C, TDP = 8W)	● -	● -	● -	-	-	-	-	-
Other NVMe/SATA SSD in APlist (rated to 70C)	● -	● -	● -	● -	● -	● -	-	-
<b>PSU</b>	<b>PSU Support (CPU Power :225w)</b>							



Intel® Server System M50FCP2UR Technical Product Specification

2100W	● -	● -	● -	● -	V	● -	● -	-
1600W	● -	● -	● -	● -	● -	● -	● -	-
1300W	● -	● -	● -	● -	● -	● -	● -	-
<b>OCP V3</b>	<b>OCP V3 Support</b>							
OCP 25W w/ class-2 QSFP	● -	● -	● -	● -	● -	● -	● -	-
<b>Battery Backup</b>	<b>Battery Backup Support</b>							
BBU inlet (rated to 45C)	● -	● -	● -	● -	● -	● -	○ -	-

**Table 82. Thermal Configuration Matrix with Single 5<sup>th</sup> Gen Processors Installed Normal Operating Mode (Table 4 of 4) (M50FCP2UR312 with 1U Heat Sink)**

Intel® Server M50FCPR2UR2312, 1U Heatsink, 1 Socket, Air-cooled								
Max Ambient Temperature	15°C	20°C	25°C	27°C	32°C	35°C	40°C	45°C
<b>CPU SKU</b>	<b>CPU Support (TDP:185W)</b>							
Intel® Xeon® Gold 5512U, 185W, 28C	● -	● -	● -	● -	● -	○ -	-	-
Intel® Xeon® Gold 5515+, 165W, 8C	● -	● -	● -	● -	○ -	-	-	-
Intel® Xeon® Silver 4516Y+, 185W, 24C	● -	● -	● -	● -	○ -	-	-	-
Intel® Xeon® Gold 4514Y, 150W, 16C	● -	● -	● -	● -	● -	○ -	-	-
Intel® Xeon® Silver 4510, 150W, 12C	● -	● -	● -	● -	● -	○ -		
<b>Memory Type</b>	<b>Memory Support</b>							
DDR5, DRx8, 1x, 1DPC	● -	● -	● -	● -	● -	● -	● -	● -
DDR5, DRx4, 1x, 1DPC	● -	● -	● -	● -	● -	● -	○ -	-
DDR5, QRx4, 1x, 1DPC	● -	● -	● -	● -	○ -	○ -	-	-

Intel® Server System M50FCP2UR Technical Product Specification

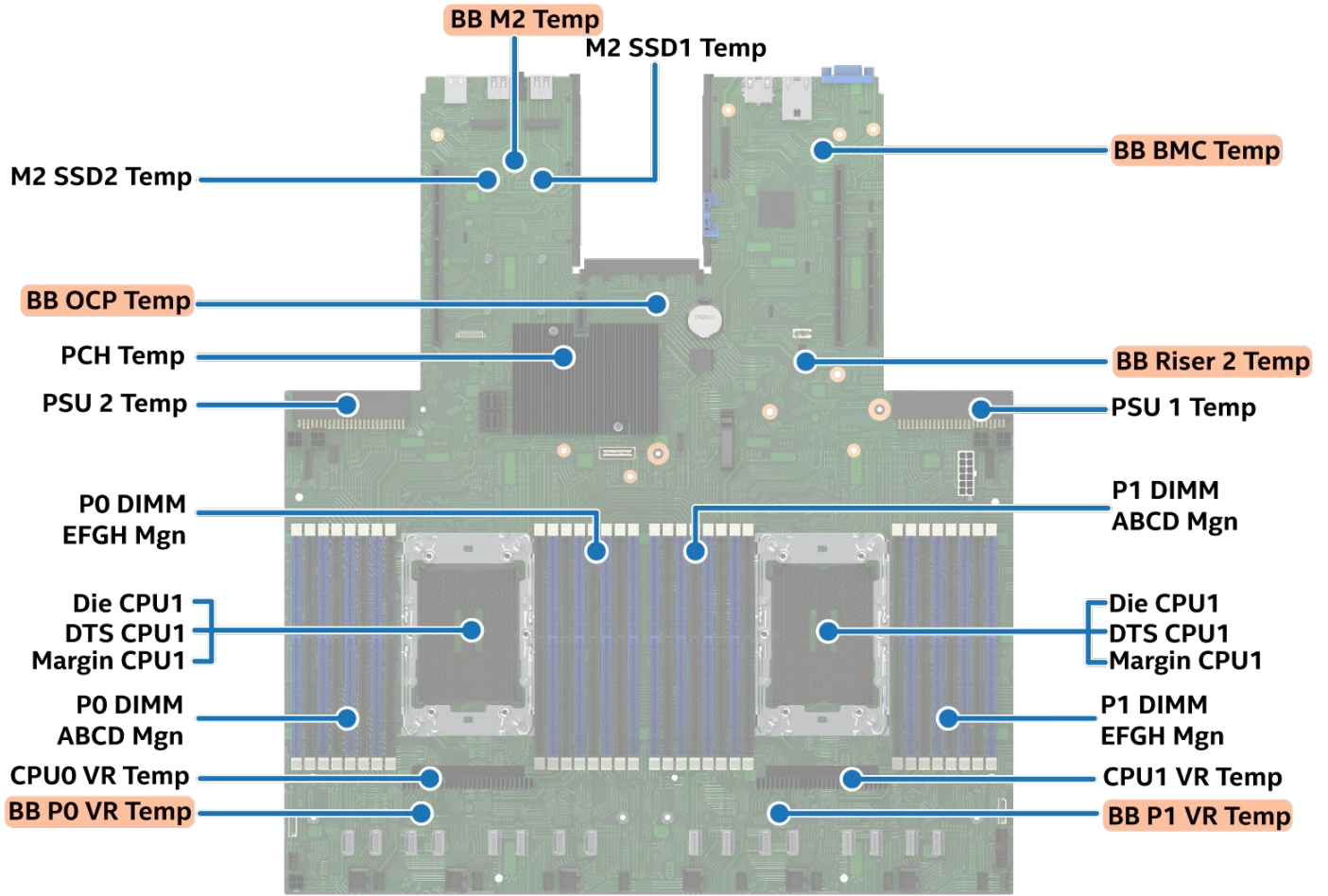
DDR5, DRx8, 1x, 2DPC	● -	● -	● -	● -	● -	● -	● -	● -
DDR5, DRx4, 1x, 2DPC	● -	● -	● -	● -	● -	● -	● -	● -
DDR5, QRx4, 1x, 2DPC	● -	● -	● -	● -	● -	● -	● -	● -
DDR5, DRx8, 2x, 1DPC	● -	● -	● -	● -	● -	● -	● -	● -
DDR5, DRx4, 2x, 1DPC	● -	● -	● -	● -	● -	● -	● -	● -
DDR5, QRx4, 2x, 1DPC	● -	● -	● -	● -	● -	● -	○ -	-
DDR5, DRx8, 2x, 2DPC	● -	● -	● -	● -	● -	● -	● -	● -
DDR5, DRx4, 2x, 2DPC	● -	● -	● -	● -	● -	● -	● -	● -
DDR5, QRx4, 2x, 2DPC	● -	● -	● -	● -	● -	● -	● -	● -
<b>PCI Card Cooling</b>	<b>Supported Thermal Level</b>							
Riser 1 slot 1	LEVEL6 / -	LEVEL6 / -	LEVEL6 / -	LEVEL6 / -	LEVEL6 / -	LEVEL5 / -	LEVEL5 / -	LEVEL3 / -
Riser 1 slot 2	LEVEL7 / -	LEVEL6 / -	LEVEL6 / -	LEVEL6 / -	LEVEL6 / -	LEVEL6 / -	LEVEL4 / -	LEVEL3 / -
Riser 1 slot 3	LEVEL7 / -	LEVEL7 / -	LEVEL6 / -	LEVEL6 / -	LEVEL6 / -	LEVEL5 / -	LEVEL4 / -	LEVEL4 / -
Riser 2 slot 1	N/A	N/A	N/A	N/A	N/A	N/A	N/A	N/A
Riser 2 slot 2	N/A	N/A	N/A	N/A	N/A	N/A	N/A	N/A
Riser 2 slot 3	N/A	N/A	N/A	N/A	N/A	N/A	N/A	N/A
Riser 3 slot 1	N/A	N/A	N/A	N/A	N/A	N/A	N/A	N/A
Riser 3 slot 2	N/A	N/A	N/A	N/A	N/A	N/A	N/A	N/A
<b>3.5" SAS/SATA SSD</b>	<b>3.5" SAS/SATA SSD Support</b>							
Rated to 60C	● -	● -	● -	● -	● -	● -	● -	● -
<b>2.5" PCIe NVMe SSD</b>	<b>2.5" PCIe NVMe SSD Support</b>							
NVMe TDP = 25W, Rated to 70C	● -	● -	● -	● -	● -	● -	● -	● -
<b>GPGPU card type</b>	<b>GPGPU card Support</b>							
Nvidia DW GPGPU - A16/A30/A40/A100-40G/A100-80G/H100	-	-	-	-	-	-	-	-
Intel® FPGA PAC D5005 - DW - 225W	-	-	-	-	-	-	-	-

Intel® Server System M50FCP2UR Technical Product Specification

PonteVecchio - DW - 300W	-	-	-	-	-	-	-	-
Intel ATS M1 - FH, 3/4 Length, Single Slot - 150W	-	-	-	-	-	-	-	-
Nvidia Tesla A2 - LP- 60W	-	-	-	-	-	-	-	-
Intel ATS M3 - LP- 75W	-	-	-	-	-	-	-	-
<b>Rear SSD above PSUs</b>	<b>Rear SSD Support</b>							
SATA SSD, Rated to 70C	● -	● -	● -	● -	● -	● -	● -	-
<b>M.2 SSD</b>	<b>M.2 NVMe SSD Support</b>							
Micron 7400/7450 series (rated to 70C, TDP = 8W)	● -	● -	● -	-	-	-	-	-
Other NVMe/SATA SSD in APlist (rated to 70C)	● -	● -	● -	● -	● -	● -	-	-
<b>PSU</b>	<b>PSU Support (CPU power: 185W)</b>							
2100W	● -	● -	● -	● -	● -	● -	● -	-
1600W	● -	● -	● -	● -	● -	● -	● -	-
1300W	● -	● -	● -	● -	● -	● -	● -	-
<b>OCP V3</b>	<b>OCP V3 Support</b>							
OCP 25W w/ class-2 QSFP	● -	● -	● -	● -	● -	● -	● -	-
<b>Battery Backup</b>	<b>Battery Backup Support</b>							
BBU inlet (rated to 45C)	● -	● -	● -	● -	● -	● -	-	-

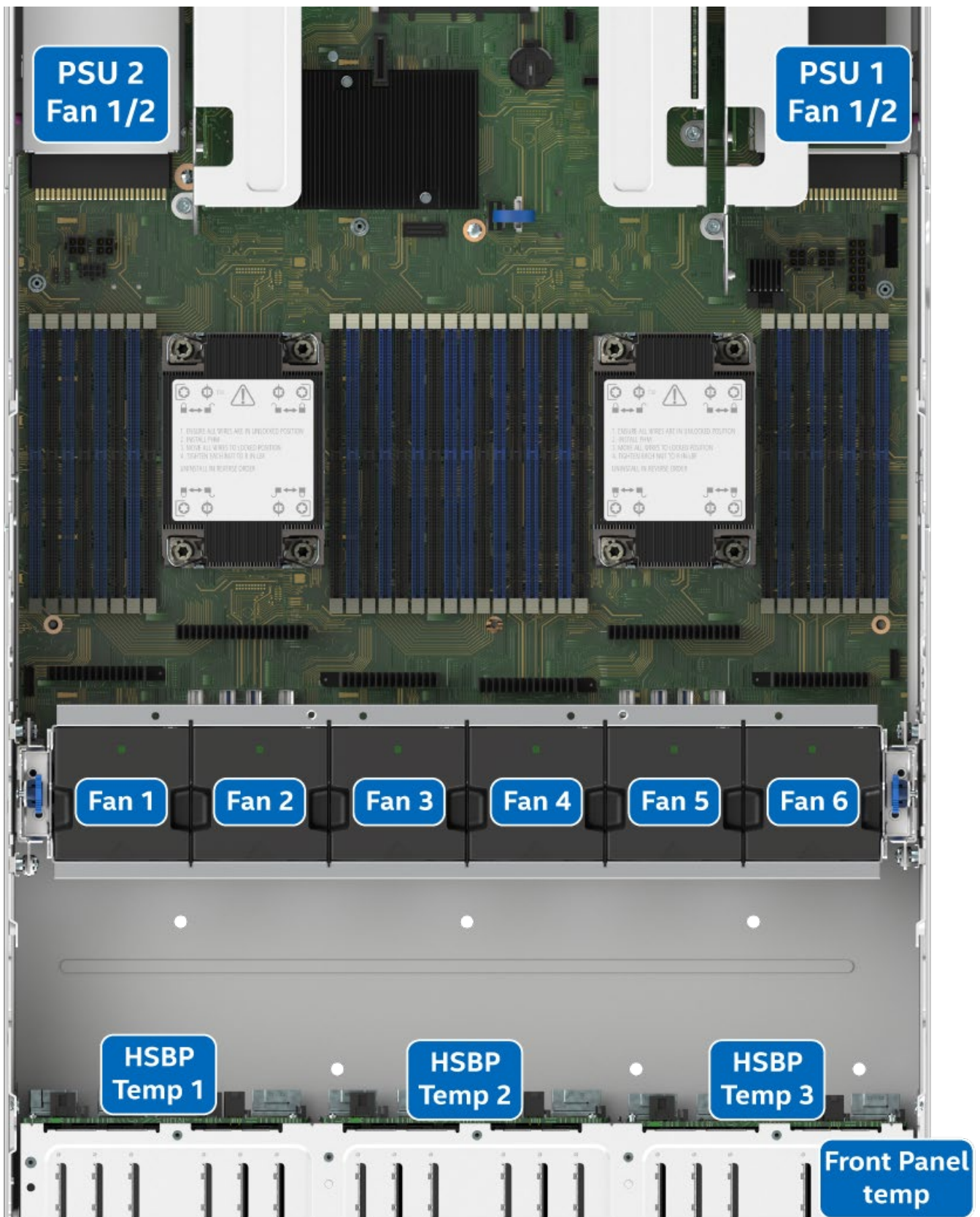
## Appendix E. System Sensors

The following figures provide the location of the sensors on the Intel® Server System M50FCP2UR..



Ref #: FCP40880

Figure 116. Server Board Sensor Map



Ref #: FCP40890

Figure 117. Server System Sensor Map

## Appendix F. Statement of Volatility

The tables in this section are used to identify the volatile and non-volatile memory components for system boards used within the Intel® Server System M50FCP2UR.

The tables provide the following data for each identified component.

- **Component Type:** Three types of components are on the server board assembly:
  - **Non-volatile:** Non-volatile memory is persistent and is not cleared when power is removed from the system. Non-volatile memory must be erased to clear data. The exact method of clearing these areas varies by the specific component. Some areas are required for normal operation of the server, and clearing these areas may render the server board inoperable
  - **Volatile:** Volatile memory is cleared automatically when power is removed from the system.
  - **Battery powered RAM:** Battery powered RAM is similar to volatile memory but is powered by a battery on the server board. Data in battery powered RAM is persistent until the battery is removed from the server board.
- **Size:** Size of each component in bits, kilobits (Kb), megabits (Mb), kilobytes (KB), or megabytes (MB).
- **Board Location:** Board location is the physical location of each component corresponding to information on the server board silkscreen.
- **User Data:** The flash components on the server boards do not store user data from the operating system. No operating system level data is retained in any listed components after AC power is removed. The persistence of information written to each component is determined by its type as described in the table.

Each component stores data specific to its function. Some components may contain passwords that provide access to that device's configuration or functionality. These passwords are specific to the device and are unique and unrelated to operating system passwords. The specific components that may contain password data are:

- **BIOS:** The server board BIOS provides the capability to prevent unauthorized users from configuring BIOS settings when a BIOS password is set. This password is stored in BIOS flash and is only used to set BIOS configuration access restrictions.
- **BMC:** The server boards support an Intelligent Platform Management Interface (IPMI) 2.0 conformant baseboard management controller (BMC). The BMC provides health monitoring, alerting, and remote power control capabilities for the Intel server board. The BMC does not have access to operating system level data.

The BMC supports the capability for remote software to connect over the network, so the software can perform health monitoring and power control. This access can be configured to require authentication by a password. If configured, the BMC maintains user passwords to control this access. These passwords are stored in the BMC flash.

The Intel® Server System M50FCP2UR includes several components that can be used to store data. A list of those components is included in the following table.

**Table 83. SOV – Server Board Components**

Component Type	Size	Board Location	User Data	Name
Non-Volatile	64MB	U11	No	BIOS Flash
Non-Volatile	256MB	U19	No	BMC Flash
Non-Volatile	UFM 5,888 Kb M9K Memory 1,638 Kb	U1_FPGA	No	FPGA
Volatile	8Gb	U1_BMC	No	BMC SDRAM

System boards in the Intel® Server System M50FCP2UR may include components used to store data. The following tables provide a list of components associated with specific system boards supported by this family. For server board components, see the previous table.

**Table 84. SOV – System Board Components**

Component Type	Size	Board Location	User Data	Name
Non-Volatile	256 B	U9	No	RISER3_1U_2U_NVMe_CARD_AsteraLabs FRU
Non-Volatile	256 KB	U2	No	RISER3_1U_2U_NVMe_CARD_AsteraLabs EEPROM
Non-Volatile	256 B	U3_HF	No	FCP_2SLOT_2U_Riser1_DW FRU
Non-Volatile	256 B	U3_HF	No	FCP_2SLOT_2U_Riser2_DW FRU
Non-Volatile	256 B	U3	No	FCP_2SLOT_2U_Riser3 FRU
Non-Volatile	256 B	U101	No	FCP_1SLOT_1U_Riser1 FRU
Non-Volatile	256 B	U6	No	FCP_1SLOT_1U_Riser2 FRU
Non-Volatile	256 B	U2	No	FCP_3SLOT_2U_Riser1 FRU
Non-Volatile	256 B	U2	No	FCP_3SLOT_2U_Riser2 FRU
Non-Volatile	256 B	U5	No	FCP_1SLOT_1U_Riser2_wRT FRU
Non-Volatile	256 KB	U8	No	FCP_1SLOT_1U_Riser2_wRT EEPROM

System boards with an Intel server chassis contain components used to store data. A list of components for the system boards in the chassis is included in the following table. For server board components, see the previous tables.

**Table 85. SOV – Server Chassis Components**

Component Type	Size	Board Location	User Data	Name
Non-Volatile	256 B	U12	No	2U 8x2.5" Combo HSBP FRU
Non-Volatile	UFM 1,376 Kb M9K Memory 378 Kb	U1	No	2U 8x2.5" Combo HSBP FPGA
Non-Volatile	256 B	U4	No	2U 12x3.5 HDD (4xCombo) HSBP FRU
Non-Volatile	UFM 1,376 Kb M9K Memory 378 Kb	U1, U2	No	2U 12x3.5 HDD (4xCombo) HSBP FPGA

## Appendix G. Product Regulatory Compliance

This product has been evaluated and certified as Information Technology Equipment (ITE), which may be installed in offices, schools, computer rooms, and similar commercial type locations. The suitability of this product for other product certification categories and/or environments (such as: medical, industrial, telecommunications, NEBS, residential, alarm systems, test equipment, and so on), other than an ITE application, will require further evaluation and may require additional regulatory approvals.

Intel has verified that all L3, L6, and L9 server products<sup>1</sup> **as configured and sold by Intel** to its customers comply with the requirements for all regulatory certifications defined in the following table. It is the Intel customer's responsibility to ensure their final server system configurations are tested and certified to meet the regulatory requirements for the countries to which they plan to ship and or deploy server systems into.

	Intel® Server System M50FCP2UR	Notes
	2U "Foxcreek Pass"	Intel Project Code Name
	L6/L9 System	Product integration level
	M500002UR	Product family identified on certification
Regulatory Certification		
RCM DoC Australia & New Zealand	✓	
CB Certification & Report (International - report to include all CB country national deviations)	✓	
China CCC Certification	○	Out of CCC Scope
CU Certification (Russia/Belarus/Kazakhstan)	○	
Europe CE Declaration of Conformity	✓	
FCC Part 15 Emissions Verification (USA & Canada)	✓	
Germany GS Certification	✓	
India BIS Certification	●	Only L9 at HOU
International Compliance – CISPR32 & CISPR35	✓	
Japan VCCI Certification	✓	
Korea KC Certification	✓	
Mexico Certification	✓	
NRTL Certification (USA&Canada)	✓	
South Africa Certification	✓	
Taiwan BSMI Certification	✓	
Ukraine Certification	○	

### Table Key

Not Tested / Not Certified	○
Tested / Certified – Limited OEM SKUs only	●
Testing / Certification (Planned)	(Date)
Tested / Certified	✓

<sup>1</sup> An L9 system configuration is a power-on ready server system with NO operating system installed. An L6 system configuration requires additional components to be installed to make it power-on ready. L3 are component building block options that require integration into a chassis to create a functional server system.



## EU Directive 2019/424 (Lot 9)

Beginning on March 1, 2020, an additional component of the European Union (EU) regulatory CE marking scheme, identified as EU Directive 2019/424 (Lot 9), will go into effect. After this date, all new server systems shipped into or deployed within the EU must meet the full CE marking requirements including those defined by the additional EU Lot 9 regulations.

Intel has verified that all L3, L6, and L9 server products<sup>2</sup> **as configured and sold by Intel** to its customers comply with the full CE regulatory requirements for the given product type, including those defined by EU Lot 9. **It is the Intel customer's responsibility to ensure their final server system configurations are SPEC® SERT™ tested and meet the new CE regulatory requirements.**

Visit the following website for additional EU Directive 2019/424 (Lot9) information:

<https://eur-lex.europa.eu/legal-content/EN/TXT/?uri=CELEX:32019R0424>

In compliance with the EU Directive 2019/424 (Lot 9) materials efficiency requirements, Intel makes available all necessary product collaterals as identified below:

- **System Disassembly Instructions**
  - *Intel® Server System M50FCP1UR Integration and Service Guide*
- **Product Specifications**
  - *Intel® Server System M50FCP2UR Technical Product Specification* (This document)
  - *Intel® Server Board M50FCP2SBSTD Technical Product Specification*
- **System BIOS/Firmware and Security Updates: Intel® Server Board M50FCP2SBSTD**
  - System Update Package (SUP): uEFI only  
<http://downloadcenter.intel.com>
- **Intel® Solid State Drive (SSD) Secure Data Deletion and Firmware Updates**
  - **Note:** for system configurations that may be configured with an Intel SSD
  - Intel® Solid State Drive Toolbox  
<https://downloadcenter.intel.com/product/35125/Memory-and-Storage>
- **Intel® RAID Controller Firmware Updates and other support collaterals**
  - **Note:** for system configurations that may be configured with an Intel® RAID Controller  
<https://www.intel.com/content/www/us/en/support/products/43732/server-products/raid-products.html>

---

<sup>2</sup> An L9 system configuration is a power-on ready server system with NO operating system installed. An L6 system configuration requires additional components to be installed to make it power-on ready. L3 are component building block options that require integration into a chassis to create a functional server system

**EU Directive 2019/424 (Lot 9) – Support Summary****Intel® Server System M50FCP2UR (Fox Creek Pass)**

A template to report information needed for (EU) 2019/424 (Lot 9) server conformity assessment. The information provided herein does not represent any final shipping server system test results, and customer's actual test results for shipping server configurations may differ from this list. Use of this information is at the sole risk of the user, and Intel assumes no responsibility for customers server system level regulation compliance to EU 2019/424 (Lot 9).

<b>Product Information</b>																					
Product Type	Server																				
Manufacturer Name	Intel Corporation																				
Registered trade name and address	Intel 2200 Mission College Blvd, Santa Clara, CA 95054-1594, USA																				
Product model number and model numbers for low end performance and high-end performance configure if applicable	M500002UR																				
Year Of Launch	2023																				
PSU efficiency at 10%, 20%, 50% and 100% of rated output power	AXX1600TCRPS (PSSF162205A) – 1600W AC Titanium FCXX2100CRPS (PSSF212201A) – 2100W AC Platinum AXX2100TCRPS (PSSF212202A) - 2100W AC Titanium <table border="1" data-bbox="743 850 1442 1020"> <thead> <tr> <th>Model</th> <th>10%</th> <th>20%</th> <th>50%</th> <th>100%</th> </tr> </thead> <tbody> <tr> <td>AXX1600TCRPS</td> <td>90.95%</td> <td>94.57%</td> <td>96.25%</td> <td>95.15%</td> </tr> <tr> <td>FCXX2100CRPS</td> <td>90.95%</td> <td>93.90%</td> <td>94.89%</td> <td>93.31%</td> </tr> <tr> <td>AXX2100TCRPS</td> <td>91.43%</td> <td>94.66%</td> <td>96.11%</td> <td>94.77%</td> </tr> </tbody> </table>	Model	10%	20%	50%	100%	AXX1600TCRPS	90.95%	94.57%	96.25%	95.15%	FCXX2100CRPS	90.95%	93.90%	94.89%	93.31%	AXX2100TCRPS	91.43%	94.66%	96.11%	94.77%
Model	10%	20%	50%	100%																	
AXX1600TCRPS	90.95%	94.57%	96.25%	95.15%																	
FCXX2100CRPS	90.95%	93.90%	94.89%	93.31%																	
AXX2100TCRPS	91.43%	94.66%	96.11%	94.77%																	
PSU factor at 50% of rated load level	0.99 (PSSF162205A) 1.00 (PSSF212201A) 0.9984(PSSF212202A)																				
PSU Rated Power Output (Server Only)	1600W (PSSF162205A) 2100W (PSSF212201A)																				
Idle state power (Server only) (Watts)	See the following table																				
List of all components for additional idle power allowances (server only)	See the following table																				
Maximum power (Server only)	See the following table																				
Declared operating condition class	Class A2 – Continuous Operation. 10°C to 35°C with the maximum rate of change not to exceed 10°C per hour.																				
Idle State Power (watts) at the higher boundary temp (Server Only)	See the following table																				
the active state efficiency and the performance in active state of the server (server only)	See the following table																				
Information on the secure data deletion functionality	See the following table																				
for blade server, a list of recommended combinations with compatible chassis (Server only)	Not Applicable																				
If Product Model Is Part Of A Server Product Family, a list of all model configurations that are represented by the model shall be supplied (Server only)	Not Applicable																				

## Energy Efficiency Data of M500002UR – 1 (Single) processor Installed Configurations

Configuration			1 CPU Low-end Config.	1 CPU High-end Config.
Details	Chassis	Model	M500002UR	
	Node/MB	Quantity	1	1
		Model	M50FCP	M50FCP
	CPU	Quantity	1 per Node	1 per Node
		Model	“Sapphire Rapids” Intel® Xeon® Gold 5415+	“Sapphire Rapids” Intel® Xeon® Platinum 8458P
	Memory	Quantity	8 per Node	8 per Node
		Capacity per DIMM (GB)	16GB	16 GB
		Total Memory Amount (GB)	128 GB	128 GB
	SSD	SSD Quantity	2	2
	PSU	Quantity	1	1
		Model	PSSF162205A	PSSF162205A
FW		BIOS: SE5C7411.86B.8612.D04 FRU: 0.0.3 BMC: V1.24 Windows Server 2019	BIOS: SE5C7411.86B.8213.D06 FRU: 0.0.3 BMC: V1.17 Windows Server 2019	
Measured and Calculated Server Allowance	P Base		25	25
	Additional CPU		60.5	255.2
	Additional Power Supply		0	0
	Storage Devices		10	10
	Additional Memory		22.32	22.32
	Additional I/O Device (10Gx 15W/2Port on MB)		0	0
	Perfcpu		6.05	25.52
Limits/ Results	Idle power allowances (W)		117.8	312.5
	Idle power tested (W) Per node		<b>107.7</b>	<b>133.3</b>
	Minimum Eff <sub>ACTIVE</sub>		9	9
	Eff <sub>ACTIVE</sub> tested		<b>30.8</b>	<b>54.3</b>
Other test result	Idle Power at Higher Temp. (per Node) @ 35 °C		124.1	144.6
	Max Power (W Per Node)		252.7	520

## Energy Efficiency Data of M50002UR – 2 (Dual) CPU Installed Configuration

Configuration			2 CPUs Low-end Config.	2 CPUs High-end Config.
Details	Chassis	Model	<b>M500002UR</b>	
	Node/MB	Quantity	1	1
		Model	M50FCP	M50FCP
	CPU	Quantity	2 per Node	2 per Node
		Model	“Sapphire Rapids” Intel® Xeon® Gold 5415+	“Sapphire Rapids” Intel® Xeon® Platinum 8458P
	Memory	Quantity	16 per Node	16 per Node
		Capacity per DIMM (GB)	16 GB	16 GB
		Total Memory Amount (GB)	256 GB	256 GB
	SSD	SSD Quantity	2	2
	PSU	Quantity	2	2
		Model	PSSF162205A	PSSF162205A
FW		BIOS: SE5C7411.86B.8612.D04 FRU: 0.0.3 BMC: V1.24 Windows Server 2019	BIOS: SE5C7411.86B.8213.D06 FRU: 0.0.3 BMC: V1.17 Windows Server 2019	
Measured and Calculated Server Allowance	P Base		38	38
	Additional CPU		82.5	343.6
	Additional Power Supply		10	10
	Storage Devices		10	10
	Additional Memory		45.36	45.36
	Additional I/O Device (10Gx 15W/2Port on MB)		0	0
	Perfcpu		11.79	49.09
Limits/ Results	Idle power allowances (W)		185.9	447
	Idle power tested (W) Per node		<b>165</b>	<b>216.8</b>
	Minimum Eff <sub>ACTIVE</sub>		9.5	9.5
	Eff <sub>ACTIVE</sub> tested		<b>32.6</b>	<b>57.6</b>
Other test result	Idle Power at Higher Temp. (per Node) @ 35 °C		190	236.3
	Max Power (W Per Node)		450.2	961.4

## Other Information:

<b>Chemical Declaration</b>
<ul style="list-style-type: none"> <li>Neodymium Not Applicable. (No HDD offered by Intel)</li> <li>Cobalt Not Applicable. (No BBUs. Coin battery is out of scope)</li> </ul>

## Appendix H. Glossary

Term	Definition
<b>ACPI</b>	Advanced Configuration and Power Interface
<b>ARP</b>	Address Resolution Protocol
<b>ASHRAE</b>	American Society of Heating, Refrigerating, and Air-Conditioning Engineers
<b>BBS</b>	BIOS boot specification
<b>BMC</b>	Baseboard management controller
<b>BIOS</b>	Basic input/output system
<b>CMOS</b>	Complementary metal-oxide-semiconductor
<b>CPU</b>	Central processing unit
<b>CXL</b>	Compute Express Link
<b>DCM</b>	Data center manager
<b>DDR5</b>	Double data rate 5th edition
<b>DHCP</b>	Dynamic Host Configuration Protocol
<b>DIMM</b>	Dual in-line memory module
<b>DPC</b>	DIMMs per channel
<b>EDS</b>	External design specification
<b>EFI</b>	Extensible firmware interface
<b>FP</b>	Front panel
<b>FRB</b>	Fault resilient boot
<b>FRU</b>	Field replaceable unit
<b>GPGPU</b>	General purpose graphic processing Unit
<b>GPIO</b>	General purpose input/output
<b>GUI</b>	Graphical user interface
<b>I<sup>2</sup>C</b>	Inter-integrated circuit bus
<b>IMC</b>	Integrated memory controller
<b>IIO</b>	Integrated input/output
<b>iPC</b>	Intel Product Code
<b>IPMI</b>	Intelligent Platform Management Interface
<b>KVM</b>	Keyboard, video, mouse
<b>LED</b>	Light emitting diode
<b>LFM</b>	Linear feet per minute, airflow measurement
<b>LPC</b>	Low-pin count
<b>LRDIMM</b>	Load reduced DIMM
<b>LSB</b>	Least significant bit
<b>MCTP</b>	Management Component Transport Protocol
<b>Memory Module</b>	DDR5 DIMM is commonly referred to as “memory module”
<b>MSB</b>	Most significant bit
<b>MKTME</b>	Multi-Key Total Memory Encryption
<b>MLE</b>	Measured launched environment
<b>MM</b>	Memory mode
<b>MRC</b>	Memory reference code
<b>MSB</b>	Most significant bit
<b>MTBF</b>	Mean time between failure
<b>NAT</b>	Network address translation

Term	Definition
<b>NIC</b>	Network interface controller
<b>NMI</b>	Non-maskable interrupt
<b>NVMe*</b>	Non-Volatile Memory Express* is an optimized, high-performance scalable storage interface designed to address the needs of enterprise systems that use PCIe*-based solid-state storage. NVMe* provides efficient access to non-volatile memory storage devices. NVMe* allows host hardware and software to take advantage of the levels of parallelism possible in modern SSDs.
<b>NTB</b>	Non-transparent bridge
<b>OCuLink</b>	Optical copper link
<b>OEM</b>	Original equipment manufacturer
<b>OCP*</b>	Open Compute Project*
<b>OR</b>	Oct (8) rank
<b>OTP</b>	Over temperature protection
<b>OVP</b>	Over-voltage protection
<b>PCH</b>	Peripheral controller hub
<b>PCI</b>	Peripheral Component Interconnect
<b>PCB</b>	Printed circuit board
<b>PCIe*</b>	Peripheral Component Interconnect Express
<b>PFC</b>	Power factor correction
<b>Intel® PFR</b>	Intel® Platform Firmware Resilience
<b>PHM</b>	Processor heat sink module
<b>PMBus*</b>	Power Management Bus*
<b>PMem</b>	Persistent memory module
<b>POST</b>	Power-on self-test
<b>PSU</b>	Power supply unit
<b>PWM</b>	Pulse width modulation
<b>QR</b>	Quad rank
<b>RAID</b>	Redundant array of independent disks
<b>RAM</b>	Random access memory
<b>RAS</b>	Reliability, availability, and serviceability
<b>RCiEP</b>	Root complex integrated endpoint
<b>RDIMM</b>	Registered DIMM
<b>RGMI</b>	Reduced Gigabit Media Independent Interface
<b>RMCP</b>	Remote Management Control Protocol
<b>ROC</b>	RAID on Chip
<b>SAS</b>	Serial Attached SCSI
<b>SATA</b>	Serial Advanced Technology Attachment
<b>SCA</b>	Single Connector Attachment
<b>SCSI</b>	Small computer system interface
<b>SEL</b>	System event log
<b>Intel® SDP Tool</b>	Intel® Server Debug and Provisioning Tool
<b>SDR</b>	Sensor data record
<b>SFF</b>	Small form factor
<b>SFP</b>	Small form-factor pluggable
<b>SFUP</b>	System firmware update package
<b>Intel® SGX</b>	Intel® Software Guard Extensions
<b>SMBus</b>	System Management Bus

## Intel® Server System M50FCP2UR Technical Product Specification

Term	Definition
<b>SMTP</b>	Simple Mail Transfer Protocol
<b>SNMP</b>	Simple Network Management Protocol
<b>SOL</b>	Serial-over-LAN
<b>SR</b>	Single rank
<b>SSD</b>	Solid state device
<b>SSH</b>	Secure shell
<b>TCG</b>	Trusted Computing Group
<b>TDP</b>	Thermal design power
<b>TIM</b>	Thermal interface material
<b>Intel® TME</b>	Intel® Total Memory Encryption
<b>Intel® TME-MK</b>	Intel® Total Memory Encryption – Multi-Key (Intel® TME-MK)
<b>Intel® TDX</b>	Intel® Trust Domain Extension (Intel® TDX)
<b>TPM</b>	Trusted platform module
<b>TPS</b>	Technical product specification
<b>Intel® TXT</b>	Intel® Trusted Execution Technology
<b>UEFI</b>	Unified Extensible Firmware Interface
<b>Intel® UPI</b>	Intel® Ultra Path Interconnect
<b>VLSI</b>	Very large scale integration
<b>Intel® VMD</b>	Intel® Volume Management Device
<b>VR</b>	Voltage regulator
<b>VSB</b>	Voltage standby
<b>Intel® VROC</b>	Intel® Virtual RAID on CPU
<b>Intel® VT-d</b>	Intel® Virtualization Technology for Directed I/O
<b>Intel® VT-x</b>	Intel® Virtualization Technology for IA-32, Intel® 64 and Intel® Architecture