



# **Intel® Server System R1000WF Product Family**

## ***Technical Product Specification***

An overview of product features, functions, architecture, and support specifications.

**Revision 2.7**  
**January 2022**

<Blank page>

## Document Revision History

Date	Revision	Modifications
July 2017	1.0	<ul style="list-style-type: none"> <li>Production release.</li> </ul>
October 2017	1.1	<ul style="list-style-type: none"> <li>Updated all tables from Appendix B and Appendix C.</li> <li>Updated S2600WF Architecture Block Diagram.</li> </ul> Added Intel® QAT information: <ul style="list-style-type: none"> <li>Server Board Product Family Feature Set</li> <li>S2600WFQ Architecture Block Diagram</li> <li>Edited bullet on the section 4.1.1 Memory Slot Population Requirements</li> <li>Added subsection 3.3.8 DC Output Specification</li> <li>Corrected illustration: Figure 26, Figure 29, Figure 30, Figure 37, Figure 40</li> </ul>
November 2017	1.2	<ul style="list-style-type: none"> <li>Updated Trusted Platform Module (China version) iPC AXXTPMCHNE8 on table Intel® Server Board S2600WF product family feature set.</li> <li>Added TPM definition on Glossary section.</li> <li>Added Retimer accessory to the sections: 5.3, 6.4 and 6.4.4.</li> </ul>
August 2018	1.3	<ul style="list-style-type: none"> <li>Updated Disclaimers page. Corrected wording and typos.</li> </ul>
January 2019	2.0	<ul style="list-style-type: none"> <li>2<sup>nd</sup> Gen Intel® Xeon® processor Scalable family support.</li> <li>Intel® Optane™ DC Persistent Memory support.</li> <li>Updated Appendix C.</li> <li>Added 1300 W AC PSU support.</li> <li>Added PMM definition on Glossary section.</li> </ul>
April 2019	2.1	<ul style="list-style-type: none"> <li>Corrected illustration: Figure 76</li> <li>Updated Appendix D</li> </ul>
October 2019	2.2	<ul style="list-style-type: none"> <li>Added Figure 29. Intel® Server S2600WF Product Family Sensor Position</li> <li>Added Table 36. Intel® Server S2600WF Product Family Sensor List</li> <li>Corrected Table 66. Intel® Remote Management Module Lite accessory option (iPC – AXXRMM4LITE2)</li> </ul>
January 2020	2.3	<ul style="list-style-type: none"> <li>Updated Figure 6 to include 12V STND-BY LED</li> <li>Add Appendix G – Product Regulatory Information, including EU Lot 9 product collateral support links</li> <li>Replaced all references of Intel® RSTe to Intel® VROC (SATA RAID)</li> <li>Updated onboard RAID support content in section 6</li> </ul>
March 2020	2.4	<ul style="list-style-type: none"> <li>Added EU Lot 9 Support Summary content to Appendix G</li> </ul>
August 2020	2.5	<ul style="list-style-type: none"> <li>Updated naming conventions for Intel® server systems based on 2nd Gen Intel® Xeon® Scalable processor family</li> <li>Updated Thermal Configuration Tables</li> </ul>
October 2021	2.6	<ul style="list-style-type: none"> <li>Added DDR4 disclaimer in Section 4.</li> <li>Updated note at Table 49. Supported Intel Ethernet Network Adapters for OCP</li> </ul>
January 2022	2.7	<ul style="list-style-type: none"> <li>Updated LED State Off and Solid Green in Table 47. System status LED state definitions</li> </ul>

## ***Disclaimers***

Intel® technologies' features and benefits depend on system configuration and may require enabled hardware, software, or service activation. Performance varies depending on system configuration. No computer system can be absolutely secure. Check with your system manufacturer or retailer or learn more at [intel.com](http://intel.com).

You may not use or facilitate the use of this document in connection with any infringement or other legal analysis concerning Intel® products described herein. You agree to grant Intel a non-exclusive, royalty-free license to any patent claim thereafter drafted which includes subject matter disclosed herein.

No license (express or implied, by estoppel or otherwise) to any intellectual property rights is granted by this document.

The products described may contain design defects or errors known as errata, which may cause the product to deviate from published specifications. Current characterized errata are available on request.

Intel disclaims all express and implied warranties, including without limitation, the implied warranties of merchantability, fitness for a particular purpose, and non-infringement, as well as any warranty arising from course of performance, course of dealing, or usage in trade.

Copies of documents that have an order number and are referenced in this document may be obtained by calling 1-800-548-4725 or by visiting [www.intel.com/design/literature.htm](http://www.intel.com/design/literature.htm).

Intel®, the Intel® logo, and Xeon® are trademarks of Intel Corporation or its subsidiaries in the U.S. and/or other countries.

\*Other names and brands may be claimed as the property of others.

© Intel® Corporation

## Table of Contents

<b>1. Introduction.....</b>	<b>10</b>
1.1 Product Errata.....	10
<b>2. Server System Family Overview.....</b>	<b>11</b>
2.1 Server Board Feature Set.....	11
2.2 Server System Features.....	13
2.3 System Features Overview.....	14
2.4 Server Board Architecture.....	15
2.5 Server Board Features Overview.....	17
2.6 Back Panel Features.....	20
2.7 Front Control Panel Options.....	20
2.8 Front Drive Bay Options.....	20
2.9 Locking Front Bezel Support.....	21
2.10 System Dimensional Data.....	22
2.10.1 Chassis Dimensions.....	22
2.10.2 Label Emboss Dimensions.....	23
2.10.3 Pull-Out Tab Label Emboss Dimensions.....	23
2.11 System Cable Routing Channels.....	24
2.12 Available Rack and Cabinet Mounting Kit Options.....	25
2.13 System Level Environmental Limits.....	26
2.13.1 Intel® Server Board Use Disclaimer.....	26
2.14 System Packaging.....	27
<b>3. System Power.....</b>	<b>28</b>
3.1 Power Supply Configurations.....	28
3.2 Power Supply Module Options.....	29
3.2.1 Power Supply Module Efficiency.....	29
3.2.2 Power Supply Module Mechanical Overview.....	30
3.2.3 Power Cord Specification Requirements.....	31
3.3 AC Power Supply Input Specifications.....	33
3.3.1 Power Factor.....	33
3.3.2 AC Input Voltage Specification.....	33
3.3.3 AC Line Isolation Requirements.....	33
3.3.4 AC Line Dropout/Holdup.....	34
3.3.5 AC Line Fuse.....	34
3.3.6 AC Inrush.....	34
3.3.7 AC Line Transient Specification.....	34
3.3.8 DC Output Specification.....	35
3.3.9 Susceptibility Requirements.....	35
3.3.10 Electrostatic Discharge Susceptibility.....	35
3.3.11 Fast Transient/Burst.....	35
3.3.12 Radiated Immunity.....	35

3.3.13	Surge Immunity.....	35
3.3.14	Power Recovery .....	36
3.3.15	Voltage Interruptions .....	36
3.3.16	Protection Circuits .....	36
3.3.17	Power Supply Status LED .....	37
3.4	DC Power Supply Input Specifications (iPC – AXX750DCCRPS) .....	37
3.4.1	DC Input Voltage .....	38
3.4.2	DC Input Fuse.....	38
3.4.3	DC Inrush Current .....	38
3.4.4	DC Input under Voltage.....	38
3.4.5	DC Holdup Time and Dropout.....	38
3.4.6	DC Line Surge Voltages (Line Transients).....	38
3.4.7	Susceptibility Requirements.....	39
3.4.8	Protection Circuits .....	39
3.5	Cold Redundancy Support.....	40
3.5.1	Powering on Cold Standby Supplies to Maintain Best Efficiency .....	41
3.5.2	Powering on Cold Standby Supplies during a Fault or Overcurrent Condition.....	41
3.5.3	BMC Requirements.....	41
3.5.4	Power Supply Turn on Function .....	41
3.6	Closed Loop System Throttling (CLST).....	42
3.7	Smart Ride Through (SmaRT) .....	42
3.8	Server Board Power Connectors .....	42
3.8.1	Power Supply Module Card Edge Connector.....	42
3.8.2	Hot Swap Backplane Power Connector .....	43
3.8.3	Peripheral Power Connector .....	43
<b>4.</b>	<b>Thermal Management.....</b>	<b>44</b>
4.1	Thermal Operation and Configuration Requirements.....	45
4.1.1	Memory Slot Population Requirements .....	45
4.2	Intel® DDR4 DIMM Support Disclaimer: .....	47
4.3	Thermal Management Overview.....	48
4.3.1	Fan Speed Control.....	48
4.4	System Fans .....	51
4.5	Power Supply Module Fans .....	53
4.6	FRUSDR Utility.....	53
<b>5.</b>	<b>System Storage and Peripheral Drive Bay Overview .....</b>	<b>56</b>
5.1	Hot Swap Drive Carriers .....	57
5.2	Hot Swap Backplane Support.....	59
5.2.1	SGPIO Functionality .....	60
5.2.2	I <sup>2</sup> C Functionality.....	60
5.3	8 x 2.5" Drive SATA/SAS/NVMe* Combo Backplane.....	60
5.4	4 x 3.5" Drive Hot-Swap Backplane.....	62
<b>6.</b>	<b>Storage Controller Options Overview .....</b>	<b>63</b>

6.1	Onboard SATA Support .....	63
6.1.1	Staggered Disk Spin-Up .....	65
6.2	Onboard SATA Software RAID Support .....	65
6.2.1	Intel® VROC (SATA RAID) 6.0 .....	66
6.2.2	Intel® Embedded Server RAID Technology 2 (Intel® ESRT2) 1.60 for SATA.....	66
6.3	M.2 SSD Support .....	68
6.3.1	Embedded RAID Support.....	68
6.4	PCIe NVMe* Drive Support.....	69
6.4.1	Onboard PCIe* OCuLink Connectors.....	69
6.4.2	Intel® Volume Management Device (Intel® VMD) for NVMe*.....	69
6.4.3	Intel® Virtual RAID on CPU (Intel® VROC) VMD NVMe RAID 6.0.....	72
6.4.4	NVMe* Drive Population Rules for Intel® VROC .....	73
6.5	Intel® Integrated RAID Module Support.....	78
6.5.1	RAID Maintenance Free Backup Unit (RMFBU) Support .....	79
<b>7.</b>	<b>Front Control Panel and I/O Panel Overview .....</b>	<b>80</b>
7.1	I/O Panel Features .....	80
7.2	Control Panel Features.....	80
<b>8.</b>	<b>PCIe* Riser Card Support.....</b>	<b>84</b>
8.1	Riser Card Assembly .....	85
8.2	1U Riser Card .....	86
<b>9.</b>	<b>Intel® Ethernet Network Adapter for OCP* Support.....</b>	<b>87</b>
<b>10.</b>	<b>Basic and Advanced Server Management Features.....</b>	<b>88</b>
10.1	Dedicated Management Port .....	89
10.2	Embedded Web Server.....	89
10.3	Advanced Management Feature Support.....	91
10.3.1	Keyboard, Video, Mouse (KVM) Redirection .....	91
10.3.2	Media Redirection .....	92
10.3.3	Remote Console .....	93
10.3.4	Performance.....	93
<b>Appendix A.</b>	<b>Integration and Usage Tips .....</b>	<b>94</b>
<b>Appendix B.</b>	<b>POST Code Diagnostic LED Decoder .....</b>	<b>95</b>
B.1.	Early POST Memory Initialization MRC Diagnostic Codes .....	96
B.1.	BIOS POST Progress Codes.....	98
<b>Appendix C.</b>	<b>POST Code Errors .....</b>	<b>101</b>
C.1.	POST Error Beep Codes .....	108
<b>Appendix D.</b>	<b>System Configuration Table for Thermal Compatibility.....</b>	<b>109</b>
<b>Appendix E.</b>	<b>System Cable Routing Diagrams .....</b>	<b>133</b>
<b>Appendix F.</b>	<b>Statement of Volatility .....</b>	<b>135</b>
<b>Appendix G.</b>	<b>Product Regulatory Information.....</b>	<b>137</b>
<b>Appendix H.</b>	<b>Glossary.....</b>	<b>145</b>

## List of Figures

Figure 1. System components overview.....	14
Figure 2. 1U standard top cover .....	14
Figure 3. Server board architecture.....	15
Figure 4. Intel® Server Board S2600WFQ(R) architecture.....	16
Figure 5. Server board component/feature identification.....	17
Figure 6. Intel® Light Guided Diagnostics – LED identification.....	18
Figure 7. Intel® Light-Guided Diagnostics - DIMM fault LEDs.....	19
Figure 8. System configuration and recovery jumpers.....	19
Figure 9. Back panel feature identification.....	20
Figure 10. Front control panel options.....	20
Figure 11. 3.5" x 4 front drive bay configuration – R1304WFxxxx.....	20
Figure 12. 2.5" x 8 front drive bay configuration – R1208WFxxxx.....	20
Figure 13. Concept reference design – front bezel installation.....	21
Figure 14. Chassis dimensions .....	22
Figure 15. Label embossment dimensions .....	23
Figure 16. Pull-out tab label embossment dimensions, non-storage models.....	23
Figure 17. System cable routing channels.....	24
Figure 18. Power supply module identification.....	28
Figure 19. Power supply module mechanical overview.....	30
Figure 20. 1100-W AC power supply module mechanical drawing .....	31
Figure 21. 1300-W AC power supply module mechanical drawing .....	31
Figure 22. AC power cord specification .....	32
Figure 23. DC power cord specification .....	32
Figure 24. System airflow and fan identification .....	44
Figure 25. System DIMM population layout.....	46
Figure 26. High-level fan speed control model.....	51
Figure 27. System fan assembly .....	52
Figure 28. Server board 1U system fan connector locations .....	52
Figure 29. Intel® Server S2600WF Product Family Sensor Position.....	54
Figure 30. 2.5" drive bay, 8-drive configuration (R1208WFXXX).....	56
Figure 31. 3.5" drive bay, 4-drive configuration (R1304WFXXX).....	56
Figure 32. Hot swap drive carrier.....	57
Figure 33. Drive carrier removal.....	57
Figure 34. 2.5" SSD mounted to 3.5" drive carrier.....	57
Figure 35. Drive tray LED identification .....	58
Figure 36. Backplane installation .....	59
Figure 37. 8 x 2.5" SAS/SATA/NVMe* hot swap backplane, front side .....	60
Figure 38. 8 x 2.5" SAS/SATA/NVMe* hot swap backplane, back side.....	61
Figure 39. 4 x 3.5" hot swap backplane, font side.....	62
Figure 40. 4 x 3.5" hot swap backplane, font side.....	62



Figure 41. Onboard SATA port connector identification.....	63
Figure 42. BIOS setup Mass Storage Controller Configuration screen.....	65
Figure 43. Intel® ESRT2 SATA RAID-5 upgrade key.....	67
Figure 44. M.2 module connector locations .....	68
Figure 45. Onboard OCuLink connectors .....	69
Figure 46. NVMe* storage bus event/error handling .....	70
Figure 47. Intel® VMD support disabled in BIOS setup .....	71
Figure 48. Intel® VMD support enabled in BIOS setup .....	72
Figure 49. Intel® VROC (VMD NVMe RAID) basic architecture overview .....	72
Figure 50. Intel® VROC upgrade key.....	73
Figure 51. Backplane cabling from two PCIe* sources.....	74
Figure 52. Drive set and connector identification .....	75
Figure 53. Supported drive population for onboard OCuLink connectors .....	75
Figure 54. Drive set and connector identification .....	76
Figure 55. Supported drive population for 4- or 8-port PCIe*switch .....	77
Figure 56. Intel® Integrated RAID Module.....	78
Figure 57. Support for single RMFBU (standard option) .....	79
Figure 58. Support for dual RMFBUs (optional accessory).....	79
Figure 59. Front I/O panel features .....	80
Figure 60. Front control panel features.....	80
Figure 61. PCIe* add-in card support .....	84
Figure 62. Riser card assembly.....	85
Figure 63. Add-in card support.....	85
Figure 64. 1U one-slot PCIe* riser card (iPC – F1UL16RISER3) .....	86
Figure 65. Intel® Ethernet Network Adapter for OCP* placement.....	87
Figure 66. Intel® RMM4 Lite activation key placement.....	89
Figure 67. Dedicated management port.....	89
Figure 68. Onboard POST diagnostic LEDs.....	95
Figure 69. R1304WFxxx system cable routing diagram.....	133
Figure 70. R1208WFxxx system cable routing diagram.....	134

## **List of Tables**

Table 1. Reference documents.....	10
Table 2. Intel® Server Board S2600WF product family features.....	11
Table 3. Intel® Server System R1000WF product family configurations.....	13
Table 4. System environmental limits summary.....	26
Table 5. Product weight information.....	27
Table 6. 1100 Watt AC power supply efficiency (80 PLUS* Platinum).....	29
Table 7. 1300 Watt AC power supply efficiency (80 PLUS* Titanium).....	29
Table 8. 750 Watt DC power supply efficiency (80 PLUS* Gold).....	29
Table 9. AC power cord specifications.....	31
Table 10. DC power cable connector pinout.....	32
Table 11. AC power factor, 1100-W power supply.....	33
Table 12. AC power factor, 1300-W power supply.....	33
Table 13. AC input voltage range, 1100 W power supply.....	33
Table 14. AC input voltage range, 1300 W power supply.....	33
Table 15. AC line holdup time, 1100-W power supply.....	34
Table 16. AC line sag transient performance (10 sec interval between each sagging).....	34
Table 17. AC line surge transient performance.....	35
Table 18. Maximum load ratings.....	35
Table 19. Performance criteria.....	35
Table 20. Over current protection, 1100-W power supply.....	36
Table 21. Over voltage protection (OVP) limits, 1100-W power supply.....	37
Table 22. LED indicators.....	37
Table 23. DC input rating.....	38
Table 24. DC holdup time.....	38
Table 25. Line voltage transient limits.....	39
Table 26. Performance criteria.....	39
Table 27. Over current protection.....	40
Table 28. Over voltage protection limits.....	40
Table 29. Example load share threshold for activating supplies.....	41
Table 30. Power supply module output power connector pinout.....	42
Table 31. Hot swap backplane power connector pinout ("HSBP PWR").....	43
Table 32. Peripheral drive power connector pinout ("Peripheral PWR").....	43
Table 33. System volumetric airflow, Intel® Server System R1304WFxxx.....	44
Table 34. System volumetric airflow, Intel® Server System R1208WFxxx.....	44
Table 35. DDR4 DIMM Attributes Table for "Identical" and "Like" DIMMs.....	47
Table 36. System fan connector pinout.....	53
Table 37. Intel® Server S2600WF Product Family Sensor List.....	54
Table 38. Drive status LED states.....	58
Table 39. Drive activity LED states.....	58
Table 40. PCIe* SSD drive status LED states.....	58

Table 41. I <sup>2</sup> C cable connector pinout .....	61
Table 42. Power harness connector pinout .....	61
Table 43. SATA and sSATA controller feature support .....	64
Table 44. SATA and sSATA controller BIOS setup utility options .....	64
Table 45. CPU - PCIe* port routing .....	71
Table 46. Intel® VROC upgrade key options .....	73
Table 47. System status LED state definitions .....	81
Table 48. Power/sleep LED functional states .....	83
Table 49. Riser slot #1 and riser slot #2 PCIe* root port mapping .....	84
Table 50. Supported Intel® Ethernet Network Adapters for OCP* .....	87
Table 51. Intel® Remote Management Module 4 (Intel® RMM4) options .....	88
Table 52. Basic and advanced server management features overview .....	88
Table 53. POST progress code LED example .....	95
Table 54. MRC progress codes .....	96
Table 55. MRC fatal error codes .....	97
Table 56. POST progress codes .....	98
Table 57. POST error messages and handling .....	102
Table 58. POST error beep codes .....	108
Table 59. Integrated BMC beep codes .....	108
Table 60. Thermal configuration tables for system in “normal” operating mode for R1304 HDD WF and R1208 HDD WF .....	110
Table 61. Thermal configuration tables for the system in “normal” operating mode for R1208 NVME WF .....	116
Table 62. Thermal configuration table for system in “fan fail” operating mode for R1304 HDD WF and R1208 HDD WF .....	122
Table 63. Thermal configuration table for system in “fan fail” operating mode for R1208 NVME WF .....	127
Table 64. Intel® Server Board S2600WF (iPN – H48104-xxx) .....	136
Table 65. 1U 1-slot PCIe* riser card (iPN – H39531-xxx) .....	136
Table 66. Front panel board (iPN – H29366-xxx) .....	136
Table 67. 1U 4 x 3.5” hot swap backplane option (iPN – G97162-XXX) .....	136
Table 68. 1U 8 x 2.5” SAS hot swap backplane option (iPN – H88382-XXX) .....	136
Table 69. Intel® Remote Management Module Lite accessory option (iPC – AXXRMM4LITE2) .....	136

# 1. Introduction

This Technical Product Specification (TPS) provides system level information for the Intel® Server System R1000WF product family.

This document describes the embedded functionality and available features of the integrated server system, which includes: the chassis layout, system boards, power subsystem, cooling subsystem, storage subsystem options, and available installable options. Some system features are provided as configurable options and may not be included standard in every system configuration offered. Reference the *Intel® Server Board S2600WF Product Family Configuration Guide* for a list of configured options for all system models made available.

For more additional product information, refer to the documents listed in Table 1.

**Table 1. Reference documents**

Document Title	Document Classification
<i>Intel® Server Board S2600WF Product Family Technical Product Specification</i>	Public
<i>Intel® Server S2600WF Product Family Configuration Guide</i>	Public
<i>Intel® Server System R1000WF Product Family System Integration and Service Guide</i>	Public
<i>Intel® Server S2600WF Product Family Power Budget &amp; Thermal Configuration Tool</i>	Public
<i>Intel® Servers System BMC Firmware EPS for Intel® Xeon® processor Scalable Family</i>	Intel Confidential
<i>Intel® Server System BIOS EPS for Intel® Xeon® processor Scalable Family</i>	Intel Confidential
<i>Intel® Chipset C62X Product Family External Design Specification</i>	Intel Confidential
<i>Intel® Ethernet Connection X557-AT2 Product Brief</i>	Public
Advanced Configuration and Power Interface Specification, Revision 3.0, <a href="http://www.acpi.info/">http://www.acpi.info/</a> .	Public
Intelligent Platform Management Interface Specification, Version 2.0. 2004.	Public
Intelligent Platform Management Bus Communications Protocol Specification, Version 1.0. 1998	Public
Platform Support for Serial-over-LAN (SOL), TMode, and Terminal Mode External Architecture Specification, Version 1.1, 02/01/02	Public
<i>Intel® Remote Management Module User Guide</i>	Public
Alert Standard Format (ASF) Specification, Version 2.0, 23 April 2003, ©2000-2003, Distributed Management Task Force, Inc., <a href="http://www.dmtf.org">http://www.dmtf.org</a> .	Public
<i>SmaRT &amp; CLST Architecture on Intel Systems and Power Supplies Specification</i>	Public
<i>Intel® Remote Management Module 4 Technical Product Specification</i>	Public
<i>Intel® Remote Management Module 4 and Integrated BMC Web Console User Guide</i>	Public

EPS and EDS documents are made available under NDA with Intel and must be ordered through an Intel representative.

## 1.1 Product Errata

Product that is currently shipping may have features or functionality that deviate from published specifications. These deviations are generally discovered after the product has gone into formal production. Intel terms these deviations as product errata. Known product errata are published in the Specification Update for the given product family, which can be downloaded from <http://www.intel.com/support>.

## 2. Server System Family Overview

The 1U server platforms within the Intel® Server System R1000WF product family offer a variety of system options to meet varied configuration requirements of high-density, high-performance computing environments.

This section provides a high-level overview of the system features and available options supported in different system models within this product family. Greater detail for each major subsystem, feature, or option is provided in later sections.

**Important Note:** All product order codes ending with 'R' identify new product versions that are available as of revision 2.0 of this document. While product order codes not ending with 'R' may be referenced within this document, only product order codes ending in '(R)' cover both SKU derivations (i.e., S2600WFT(R) covers S2600WFT and S2600WFTR).

### 2.1 Server Board Feature Set

Table 2 identifies the feature set of each supported server board.

**Note:** Not all server board features identified in Table 2 are supported in the 1U chassis. See Table 3 for specific 1U system features.

**Table 2. Intel® Server Board S2600WF product family features**

Intel® Server Board Feature	iPC - S2600WFT(R)	iPC - S2600WF0(R)	iPC - S2600WFQ(R)
<b>Processor</b>	<ul style="list-style-type: none"> <li>• (2) – LGA3647-0 (Socket P) processor sockets</li> <li>• Supports (1) or (2) processors from the 1<sup>st</sup> and 2<sup>nd</sup> Gen Intel® Xeon® processor Scalable family (Platinum, Gold, Silver, and Bronze).</li> </ul> <p><b>Note:</b> Previous generation Intel® Xeon® processors are not supported.</p> <ul style="list-style-type: none"> <li>• Maximum supported Thermal Design Power (TDP) of up to 205 W (board only)</li> </ul> <p><b>Note:</b> Intel® Server Systems based on this server board family may support a lower maximum Thermal Design Power (TDP). See the appropriate Intel® Server System TPS for maximum supported TDP.</p>		
<b>Memory Support</b>	<ul style="list-style-type: none"> <li>• 24 DIMM Slots (12 per CPU)</li> <li>• DDR4 RDIMM/LRDIMM, Up to 2933 MT/s, 1.2V</li> <li>• DDR4-compatible Intel® Optane™ DC persistent memory module, Up to 2666 MT/s, 1.2V</li> </ul> <p><b>Note:</b> The maximum memory speed supported is dependent on the installed processor SKU and population configuration.</p> <p><b>Note:</b> Intel® Optane™ DC persistent memory module memory is only supported in systems configured with 2nd Gen Intel® Xeon® processor Scalable family (Platinum, Gold, and select Silver SKUs)</p> <p><b>Note:</b> Intel® Optane™ DC persistent memory module memory is only supported with Board and System products that include an 'R' at the end of the product order code.</p>		
<b>Intel® C62x Series Chipset</b>	Intel® C624 Chipset	Intel® C624 Chipset	Intel® C628 Chipset
<b>Intel® Quick Assist Technology</b>	No	No	Yes
<b>Intel® Omni-Path Fabric</b>	Supported	Supported	Supported
<b>Onboard LAN</b>	Dual Port RJ45 10 GbE	No	No

Intel® Server Board Feature	iPC - S2600WFT(R)	iPC - S2600WF0(R)	iPC - S2600WFQ(R)
<b>OCP Module Support</b>	<ul style="list-style-type: none"> <li>Dual Port 10Gb RJ45 – iPC 557T2OCPG1P5</li> <li>Dual Port SFP+ – iPC 527DA2OCPG1P5</li> </ul>	<ul style="list-style-type: none"> <li>Quad Port 1Gb RJ45 – iPC I357T4OCPG1P5</li> <li>Quad Port SFP+ – iPC X527DA4OCPG1P5</li> <li>Dual Port 10Gb RJ45 – iPC X557T2OCPG1P5</li> <li>Dual Port SFP+ – iPC X527DA2OCPG1P5</li> </ul>	<ul style="list-style-type: none"> <li>Quad Port 1Gb RJ45 – iPC I357T4OCPG1P5</li> <li>Quad Port SFP+ – iPC X527DA4OCPG1P5</li> <li>Dual Port 10Gb RJ45 – iPC X557T2OCPG1P5</li> <li>Dual Port SFP+ – iPC X527DA2OCPG1P5</li> </ul>
<b>Intel® Integrated SAS Module</b>	Supported	Supported	Supported
<b>Onboard PCIe* NVMe*</b>	<ul style="list-style-type: none"> <li>(4) – OCuLink* connectors</li> <li>Intel® VROC (VMD NVMe* RAID) support (accessory option)</li> </ul>	<ul style="list-style-type: none"> <li>(4) – OCuLink* connectors</li> <li>Intel® VROC (VMD NVMe* RAID) support (accessory option)</li> </ul>	<ul style="list-style-type: none"> <li>(2) – OCuLink* connectors</li> <li>Intel® VROC (VMD NVMe* RAID) support (accessory option)</li> </ul>
<b>Onboard SATA</b>	<ul style="list-style-type: none"> <li>12 x SATA 6 Gbps ports (6 Gb/s, 3 Gb/s and 1.5 Gb/s transfer rates supported) <ul style="list-style-type: none"> <li>(2) – single port 7-pin SATA connectors</li> <li>(2) – M.2 connectors – SATA / PCIe*</li> <li>(2) – 4-port mini-SAS HD (SFF-8643) connectors</li> </ul> </li> <li>Embedded SATA Software RAID <ul style="list-style-type: none"> <li>Intel® VROC (SATA RAID) 6.0</li> <li>Intel® Embedded Server RAID Technology 2 1.60 with optional RAID 5 key support</li> </ul> </li> </ul>		<ul style="list-style-type: none"> <li>4 x SATA 6 Gbps ports (6 Gb/s, 3 Gb/s and 1.5 Gb/s transfer rates supported) <ul style="list-style-type: none"> <li>(2) – single port 7-pin SATA connectors</li> <li>(2) – M.2 connectors – SATA/PCIe*</li> </ul> </li> <li>Embedded SATA Software RAID <ul style="list-style-type: none"> <li>Intel® VROC (SATA RAID) 6.0</li> </ul> </li> </ul> <p><b>Note:</b> 4-port mini-SAS HD connectors are present on S2600WFQ(R) but are not configured as SATA; these cables are used only for Intel® QAT.</p>
<b>Riser Card</b>	Concurrent support for up to three riser cards <ul style="list-style-type: none"> <li>Riser #1 – PCIe* 3.0 x24 (CPU1 x16, CPU2 x8) – 2 and 3 slot riser card options available</li> <li>Riser #2 – PCIe* 3.0 x24 (CPU2 x24) – 2 and 3 slot riser card options available</li> <li>Riser #3 (2U systems only) – PCIe* 3.0 (CPU 2 x12) – 2 slot riser card available</li> </ul>		
<b>Video</b>	<ul style="list-style-type: none"> <li>Integrated 2D video controller</li> <li>16MB of DDR4 video memory</li> <li>(1) – DB-15 external connector</li> <li>(1) – 14-pin internal connector for optional front panel video support</li> </ul>		
<b>USB</b>	<ul style="list-style-type: none"> <li>(3) – external USB 3.0 ports</li> <li>(1) – internal type-A USB 2.0 port</li> <li>(1) – internal 20-pin connector for optional 2x USB 3.0 port front panel support</li> <li>(1) – internal 10-pin connector for optional 2x USB 2.0 port front panel support</li> </ul>		
<b>Serial Port</b>	<ul style="list-style-type: none"> <li>(1) – external RJ-45 serial-A port connector</li> <li>(1) – internal DH-10 serial-B port header for optional front or rear serial port support</li> </ul>		
<b>Server Management</b>	<ul style="list-style-type: none"> <li>Integrated baseboard management controller, IPMI 2.0 compliant</li> <li>Support for Intel® Server Management software</li> <li>Dedicated onboard RJ45 management port</li> <li>Advanced server management via Intel® RMM4 Lite – iPC AXXRMM4LITE2 (accessory option)</li> </ul>		
<b>Security</b>	<ul style="list-style-type: none"> <li>Trusted platform module 2.0 (Rest of World) – iPC AXXTPMENC8 (accessory option)</li> <li>Trusted platform module 2.0 (China Version) – iPC AXXTPMCHNE8 (accessory option)</li> </ul>		
<b>System Fan</b>	<ul style="list-style-type: none"> <li>(6) – system fans supported in two different connector formats: hot swap (2U) and cabled (1U) <ul style="list-style-type: none"> <li>(6) – 10-pin managed system fan headers (sys_fan 1–6) – used for 1U system configuration</li> <li>(6) – 6-pin hot swap capable managed system fan connectors (sys_fan 1–6) – used for 2U system configuration</li> </ul> </li> </ul>		

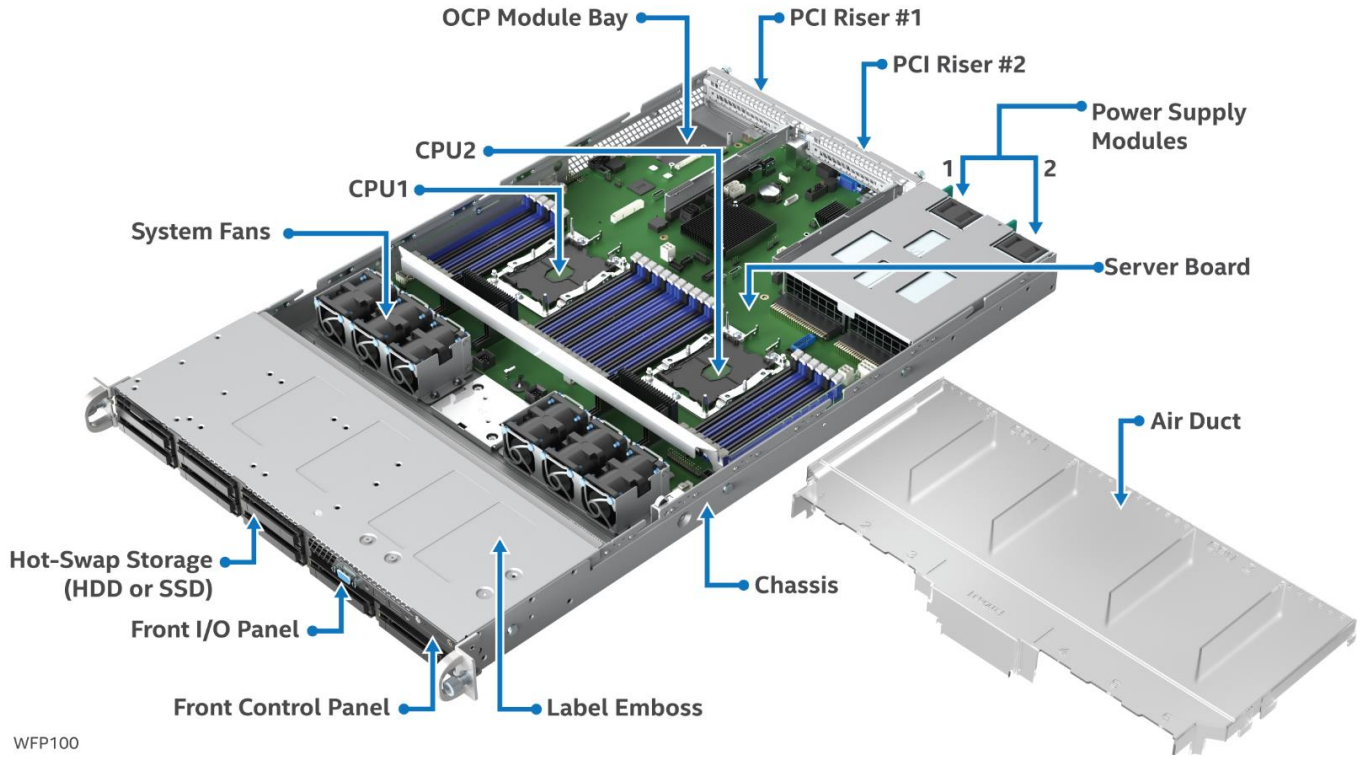
## 2.2 Server System Features

Table 3 describes the features of the server system configurations.

**Table 3. Intel® Server System R1000WF product family configurations**

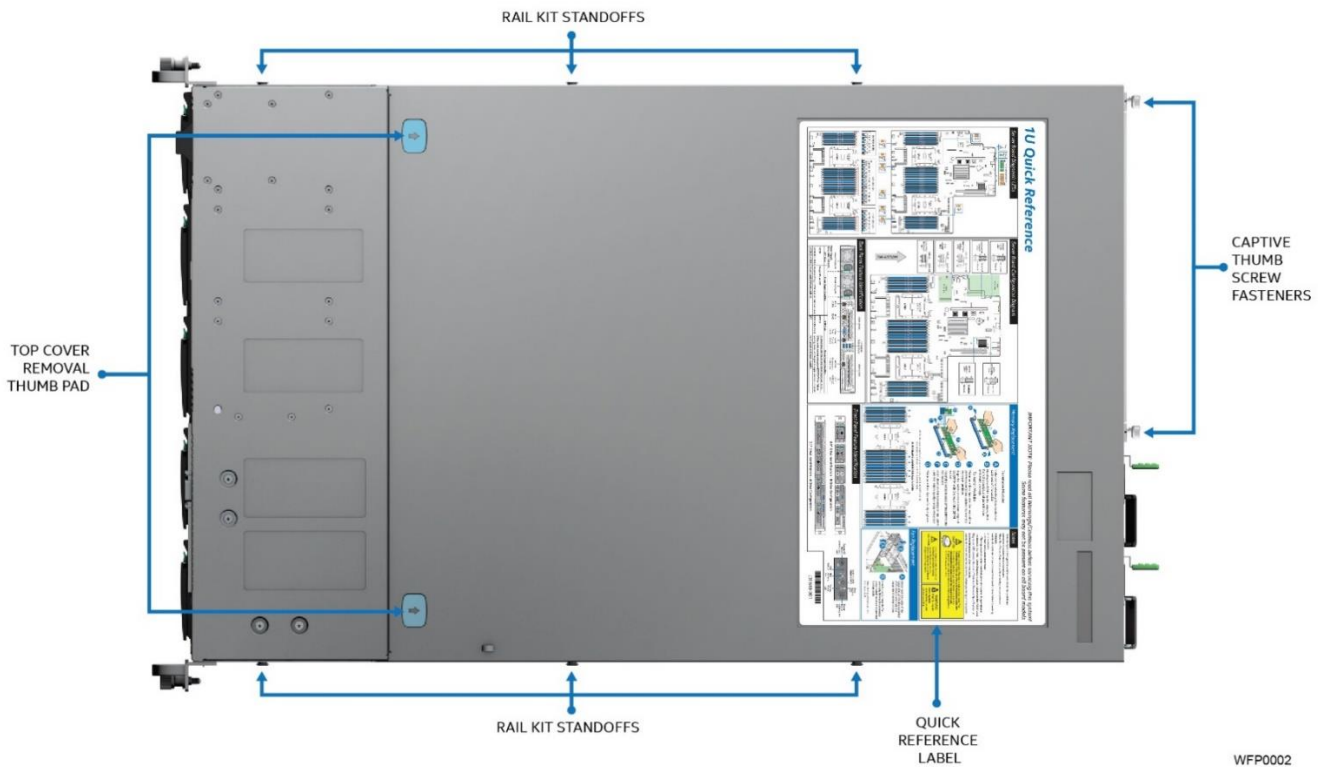
Feature	Description
<b>Chassis Type</b>	1U rack mount chassis
<b>Server Board</b>	Intel® Server Board S2600WF product family
<b>Maximum Supported Processor Thermal Design Power (TDP)</b>	Up to 165 Watts  <b>Note:</b> Intel® Server Systems in this family may support a lower maximum Thermal Design Power (TDP). See Appendix D for the maximum supported TDP.
<b>External I/O Connections</b>	<ul style="list-style-type: none"> <li>• DB-15 video connectors               <ul style="list-style-type: none"> <li>◦ Front and back</li> </ul> </li> <li>• RJ-45 serial port A connector on back panel</li> <li>• Dual RJ-45 network interface connectors (S2600WFT(R)-based systems only)</li> <li>• Dedicated RJ-45 server management port on back panel</li> <li>• (3) – USB 3.0 connectors on back panel</li> <li>• (2) – USB 3.0 connectors on front panel (non-storage system configurations only)</li> </ul>
<b>Internal I/O Connectors/Headers</b>	<ul style="list-style-type: none"> <li>• (1) – Type-A USB 2.0 connector</li> <li>• (1) – DH-10 serial port B connector</li> </ul>
<b>System Fans</b>	<ul style="list-style-type: none"> <li>• (6) – managed 40 mm dual rotor system fans</li> <li>• One power supply fan for each installed power supply module</li> </ul>
<b>Riser Card Support</b>	<p>Support for two riser cards:</p> <ul style="list-style-type: none"> <li>• Riser #1 – PCIe* 3.0 x24</li> <li>• Riser #2 – PCIe* 3.0 x24</li> </ul> <p>With two riser cards installed, up to two possible add-in cards can be supported (one x16 PCIe* 3.0 add-in card slot per riser card):</p> <ul style="list-style-type: none"> <li>• (2) full height/half-length add-in cards via Risers #1 and #2</li> </ul>
<b>Power Supply Options</b>	<p>The server system can have up to two power supply modules installed, supporting the following power configurations: 1+0, 1+1 redundant power, and 2+0 combined power.</p> <p>(2) power supply options:</p> <ul style="list-style-type: none"> <li>• AC 1100W Platinum</li> <li>• AC 1300W Titanium</li> <li>• DC 750W Gold</li> </ul>
<b>Drive Support</b>	<ul style="list-style-type: none"> <li>• R1304WFxxx – 4 x 3.5" hot swap drive bays + SAS/SATA backplane</li> <li>• R1208WFxxx – 8 x 2.5" hot swap drive bays + SAS/SATA/NVMe* combo backplane</li> </ul>
<b>Supported Rack Mount Kit Accessory Options</b>	<ul style="list-style-type: none"> <li>• AXCELVRAIL – Enhanced value rack mount rail kit – 424 mm max travel length</li> <li>• A1UFULLRAIL – Tool-less rack mount rail kit with CMA support – 780 mm max travel length</li> <li>• A1USHRTRAIL – Tool-less rack mount rail kit – 780 mm max travel length (no CMA support)</li> <li>• AXX2POSTBRCKT – Two post fixed mount bracket kit</li> <li>• AXX1U2UCMA2 – Cable management arm (supported with AXXFULLRAIL only)</li> </ul>

## 2.3 System Features Overview



**Figure 1. System components overview**

Most 2U systems within this product family include the standard top cover shown in Figure 2.



**Figure 2. 1U standard top cover**



## 2.4 Server Board Architecture

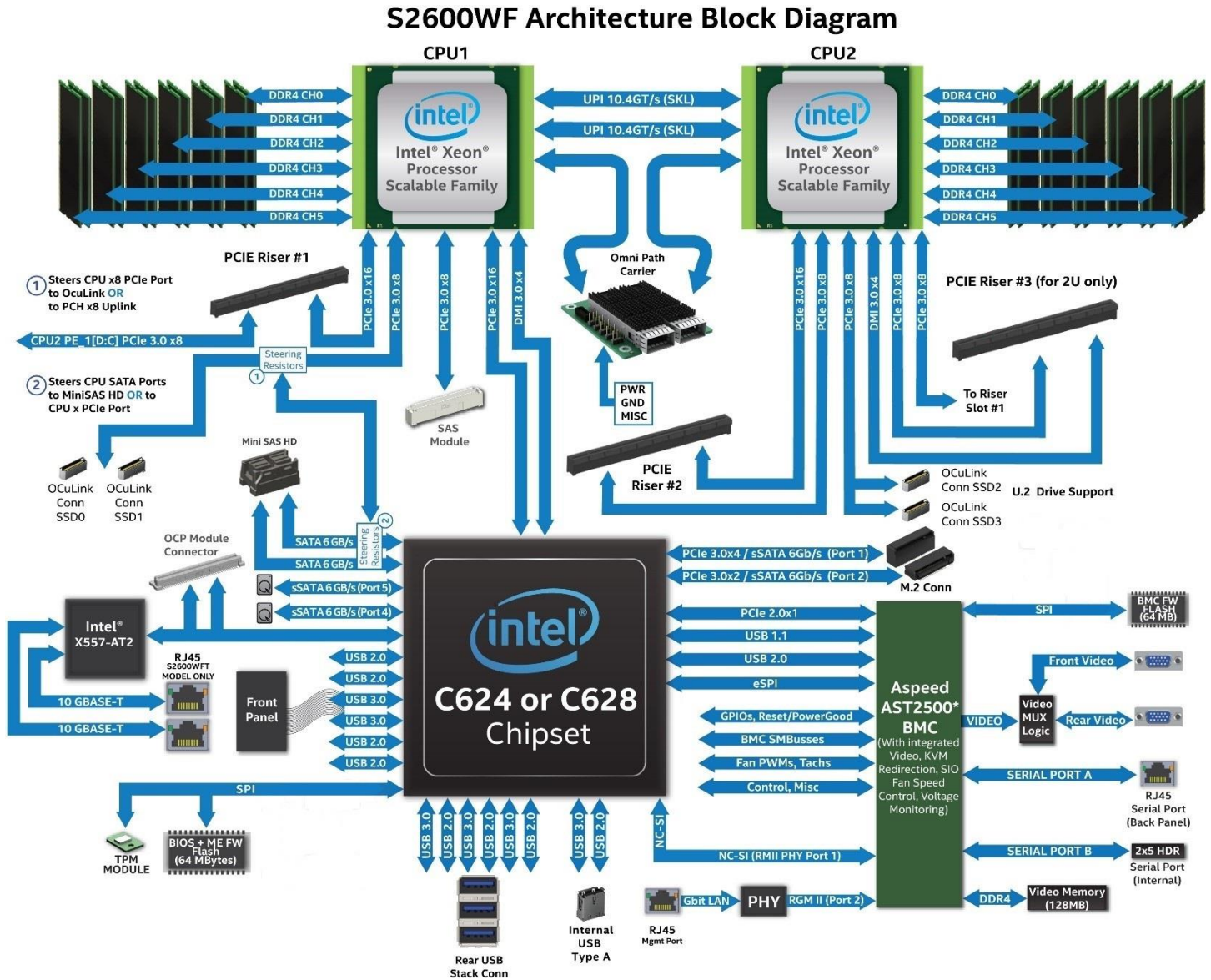


Figure 3. Server board architecture

### S2600WFQ Architecture Block Diagram

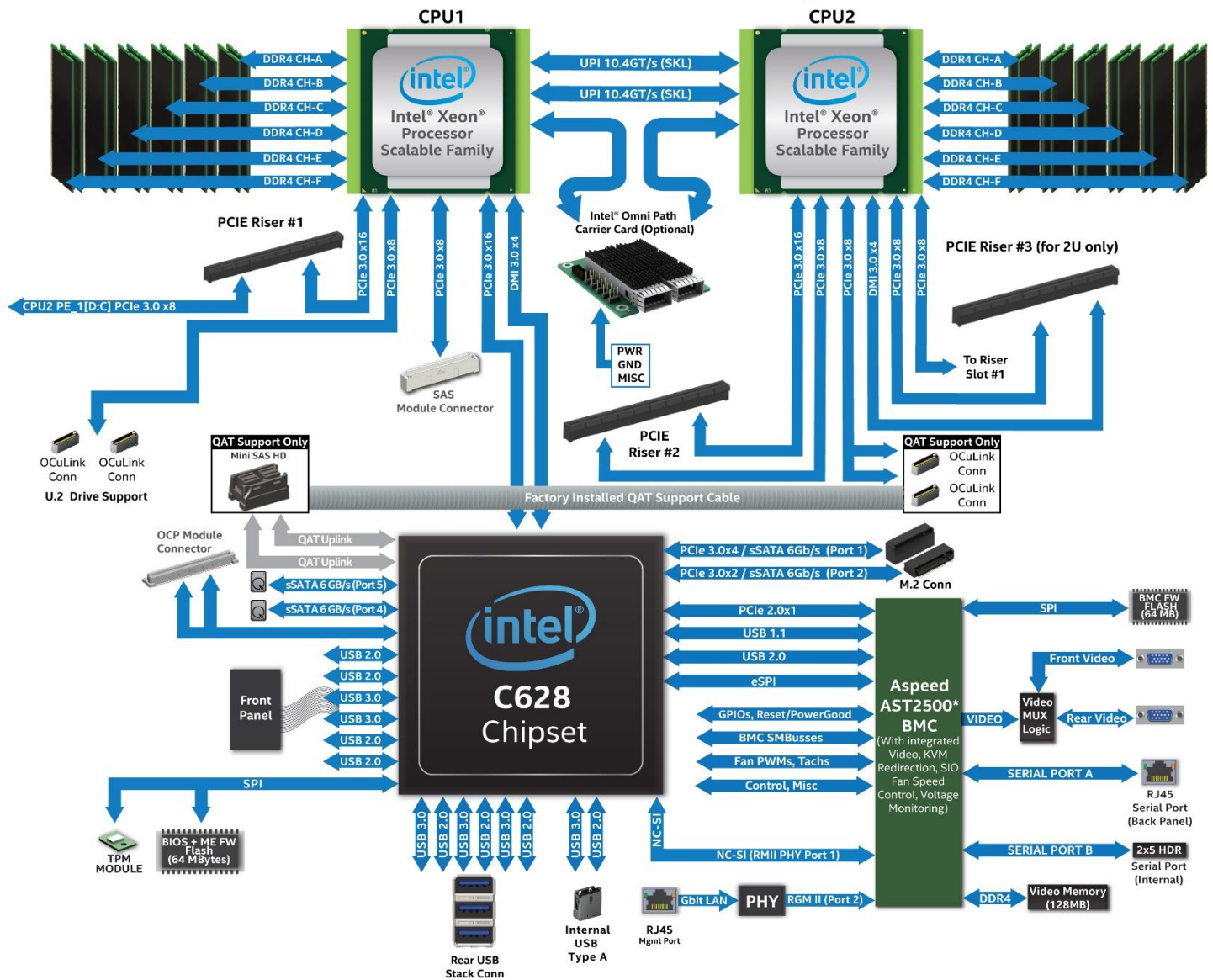


Figure 4. Intel® Server Board S2600WFQ(R) architecture

## 2.5 Server Board Features Overview

The illustration in Figure 5 provides a general overview of the server board, identifying key feature and component locations. For more information, refer to *Intel® Server Board S2600WF Technical Product Specification*.

**Note:** Intel® Server Board S2600WFT(R) is shown. Some features may not be present on Intel® Server Board S2600WF0(R) and/or S2600WFQ(R).

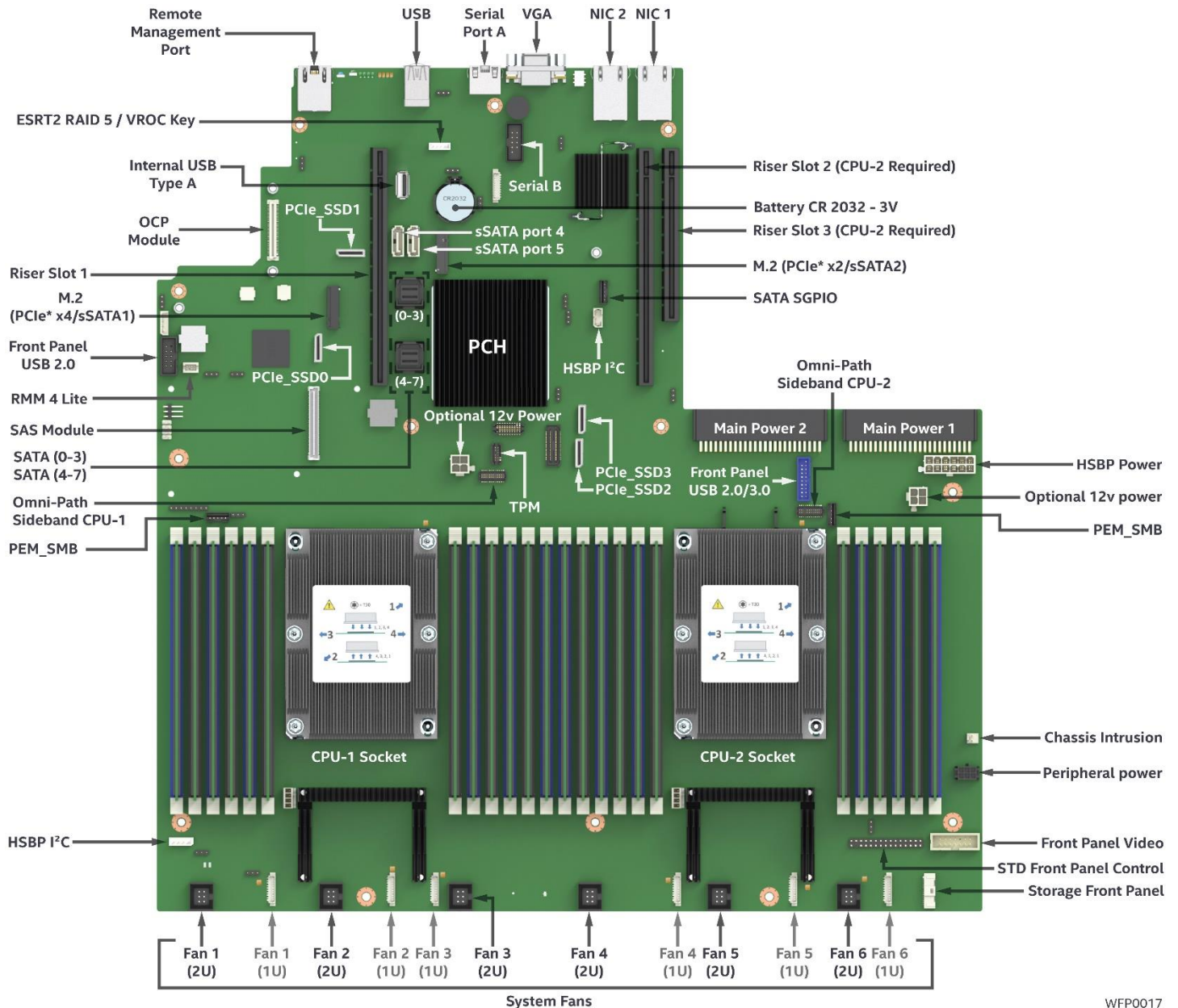


Figure 5. Server board component/feature identification

WFP0017

The server board includes several LEDs to identify system status and/or indicate a component fault. Figure 6 and Figure 7 identify each diagnostic LED and their location.

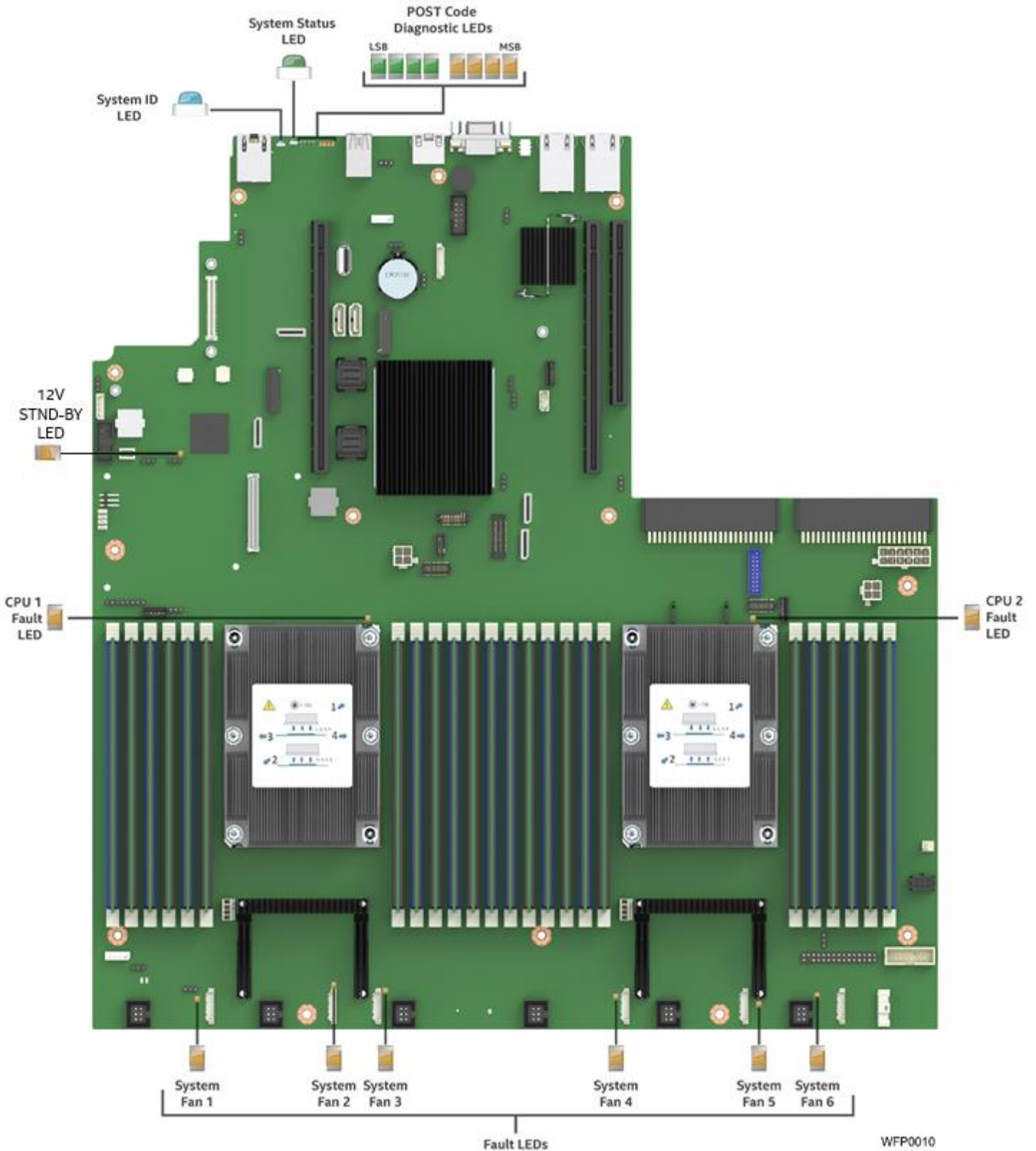
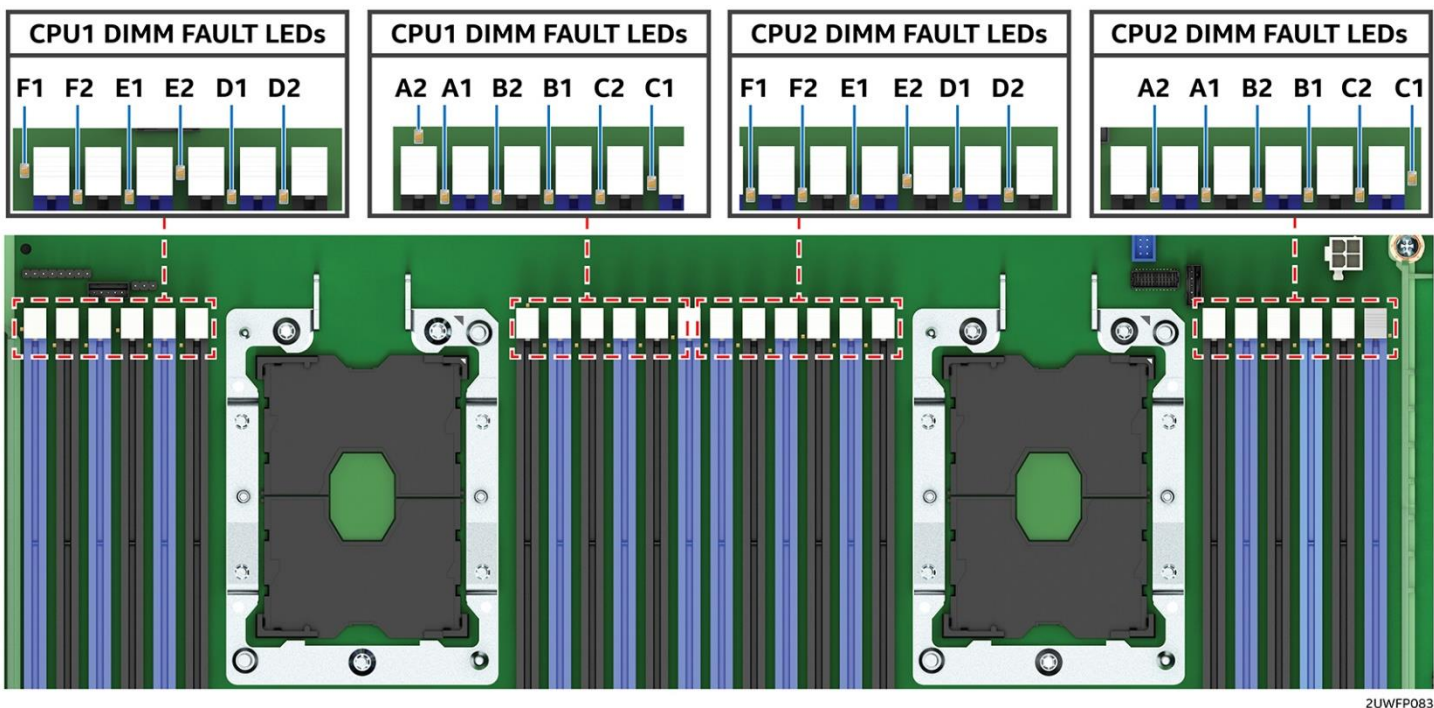


Figure 6. Intel® Light Guided Diagnostics – LED identification



2UWFP083

Figure 7. Intel® Light-Guided Diagnostics - DIMM fault LEDs

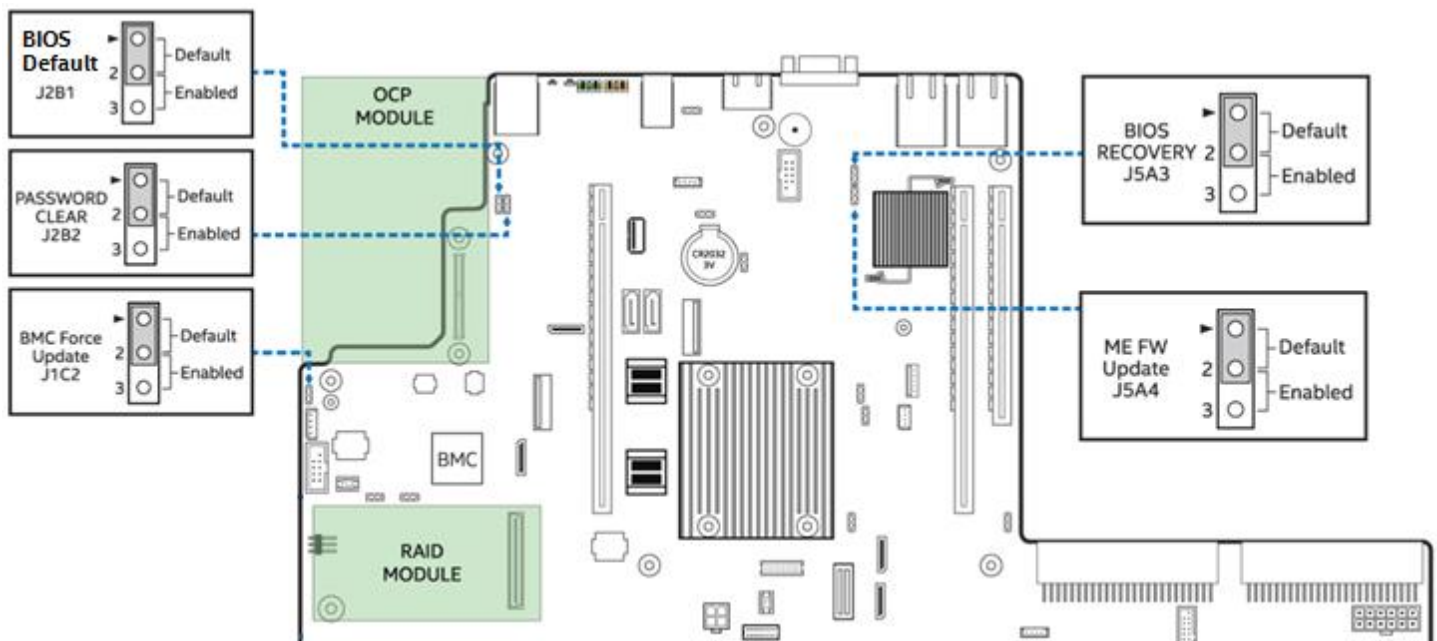


Figure 8. System configuration and recovery jumpers

## 2.6 Back Panel Features



Figure 9. Back panel feature identification

## 2.7 Front Control Panel Options

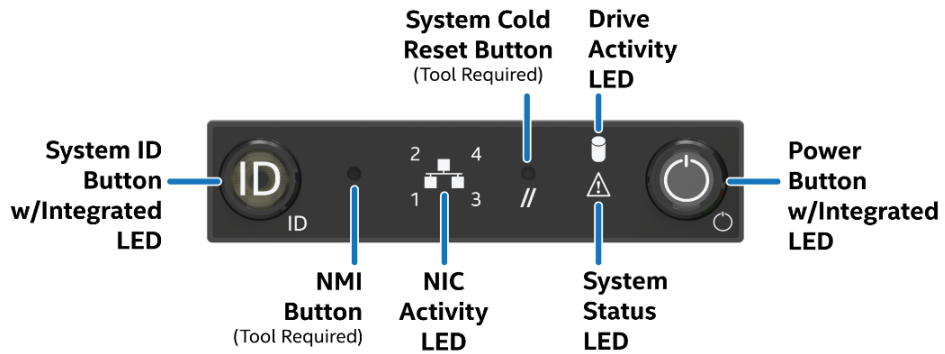


Figure 10. Front control panel options

## 2.8 Front Drive Bay Options



Figure 11. 3.5" x 4 front drive bay configuration – R1304WFxxxx



Figure 12. 2.5" x 8 front drive bay configuration – R1208WFxxxx

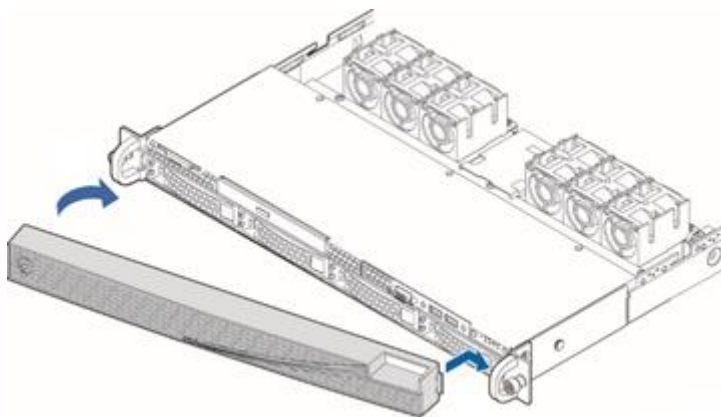
## 2.9 Locking Front Bezel Support

The Intel 1U chassis includes features designed into the rack handles and front drive bay by to support a locking front bezel.

---

**Note:** Intel does not offer a front bezel accessory option. OEMs looking to develop a locking front bezel can obtain necessary CAD files of the chassis from Intel to aid with front bezel development. Contact a local Intel representative for additional information.

---



**Figure 13. Concept reference design – front bezel installation**

## 2.10 System Dimensional Data

### 2.10.1 Chassis Dimensions

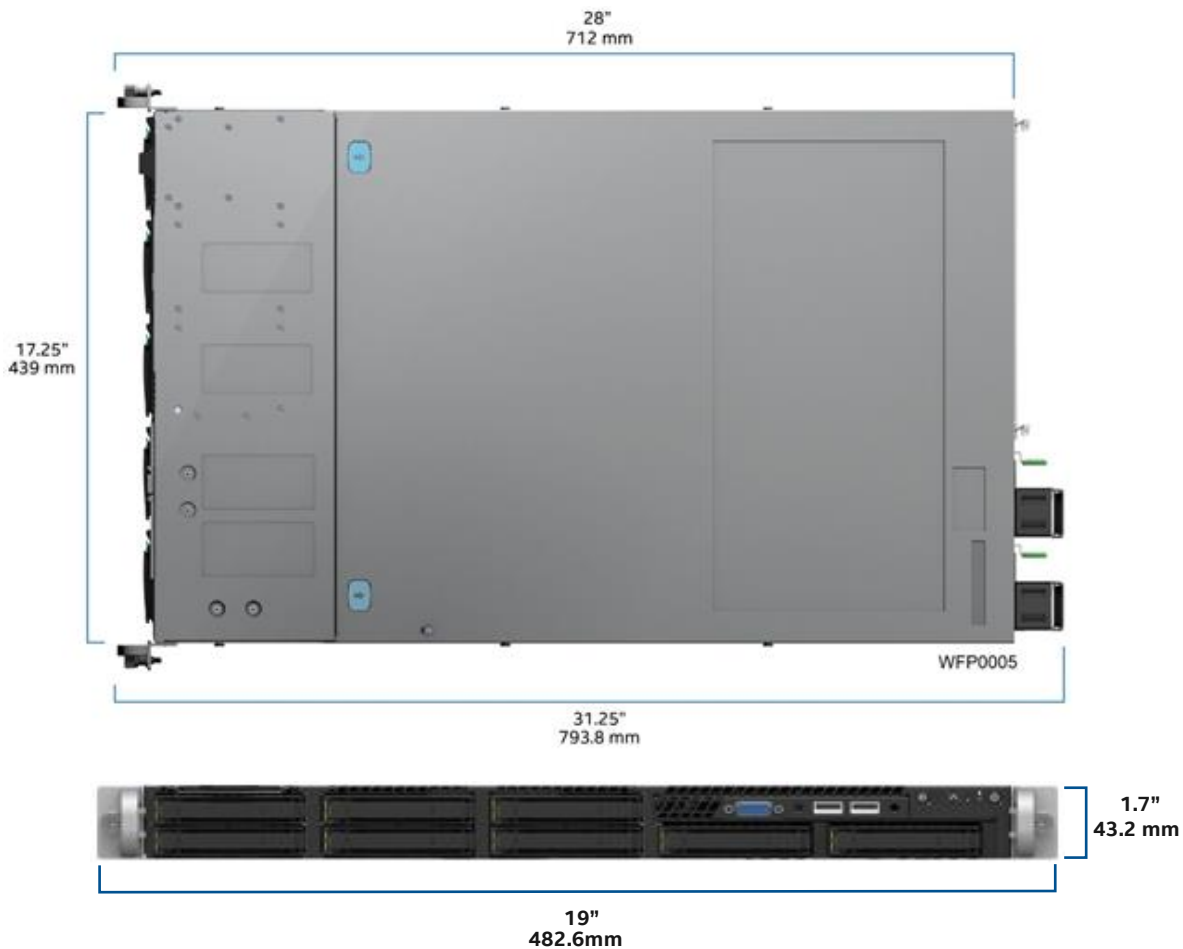


Figure 14. Chassis dimensions



### 2.10.2 Label Emboss Dimensions



Figure 15. Label embossment dimensions

### 2.10.3 Pull-Out Tab Label Emboss Dimensions

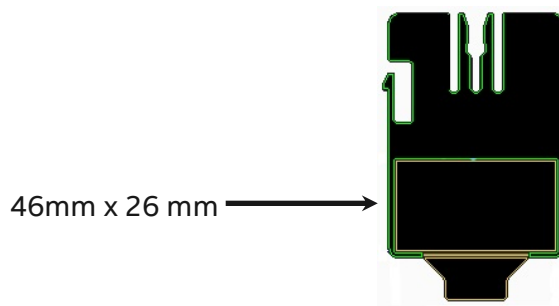
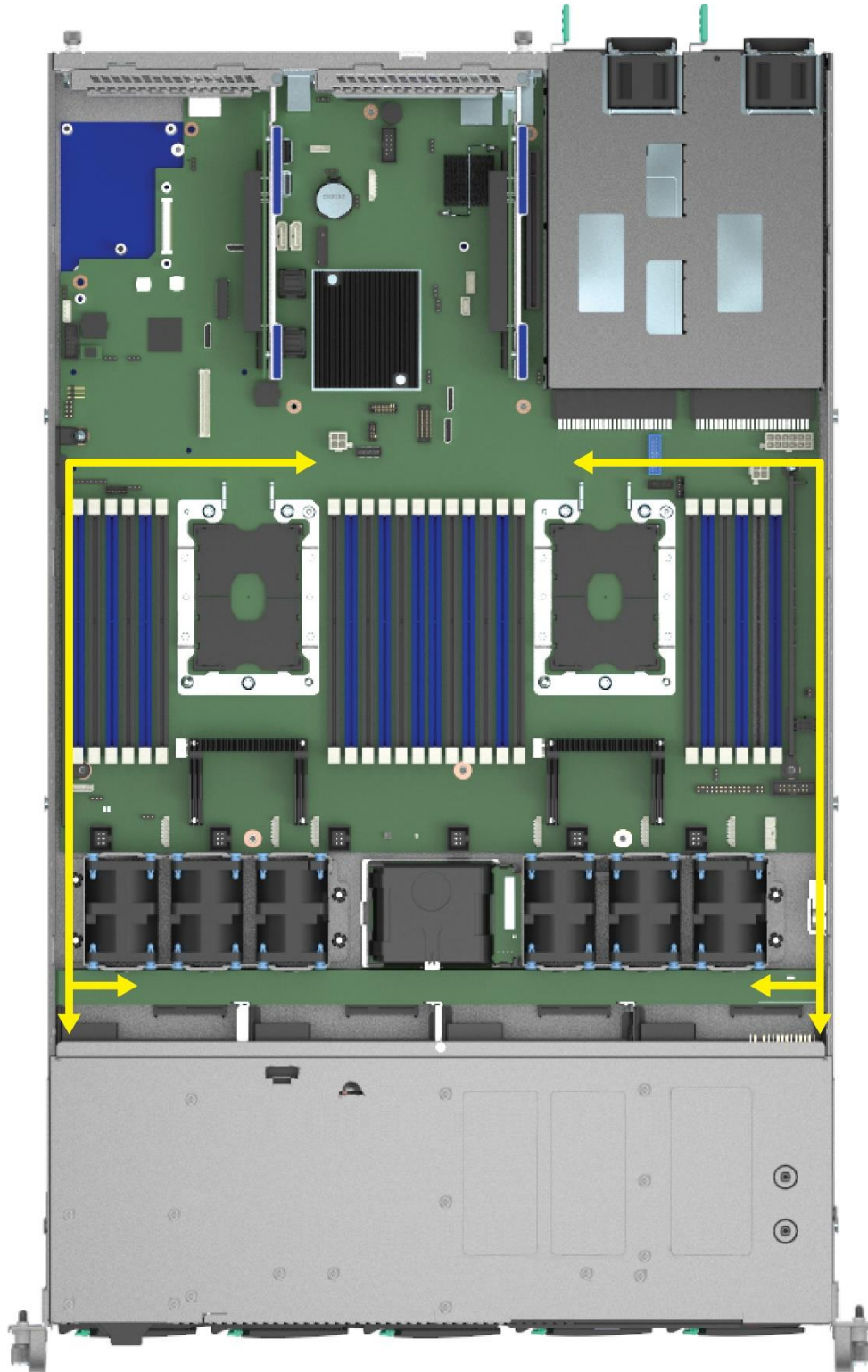


Figure 16. Pull-out tab label embossment dimensions, non-storage models

## 2.11 System Cable Routing Channels

The 1U system provides cable routing channels along each chassis sidewall. No cables should be routed directly in front of the system fans or through the center of the server board between the memory slots and CPU sockets. The system fan assembly must be removed before routing cables.

See Appendix E for additional information on supported cable routing.



WFP0011

Figure 17. System cable routing channels

## 2.12 Available Rack and Cabinet Mounting Kit Options

---

**Advisory Note:** Available rack and cabinet mounting kits are not designed to support shipment of the server system while installed in a rack. If the user chooses to do so, Intel advises the user to verify the shipping configuration with appropriate shock and vibration testing, before shipment. Intel does not perform shipping tests that cover the complex combination of unique rack offerings and custom packaging options.

**Caution:** Exceeding the specified maximum weight limit of a given rail kit or misalignment of the server in the rack may result in failure of the rack rails, causing damage to the system or personal injury. Using two people or the use of a mechanical assist tool to install and align the server into the rack is highly recommended.

---

- **AXXELVRAIL** – Enhanced Value Rack Mount Rail Kit
  - 1U, 2U, 4U compatible
  - Tool-less chassis attach
  - Tools required to attach to rails to rack
  - Rack installation length adjustment from 610mm ~ 765mm
  - 424mm travel distance (2/3 extension from rack)
  - 130 lbs. (59 kg) max support weight
  
- **A1UFULLRAIL** – Premium Rack Mount Rail Kit with cable management arm (CMA) support
  - 1U compatible
  - Tool-less installation
  - Full extension from rack
  - 780 mm travel distance
  - 39 lbs. (18 kg) maximum supported weight
  - Support for Cable Management Arm AXX1U2UCMA
  
- **A1USHRTRAIL** - Premium Rack Mount Rail Kit with no CMA support
  - 1U compatible
  - Tool-less installation
  - Full extension from rack
  - 780 mm travel distance
  - 39 lbs. (18 kg) maximum supported weight
  - No cable management arm support
  
- **AXX2POSTBRCKT** – 2-Post Fixed Mount Bracket Kit
  - 1U and 2U compatible
  - Tools required to attach components to rack
  
- **AXX1U2UCMA** – Cable Management Arm (supports A1UFULLRAIL only)

## 2.13 System Level Environmental Limits

The following table defines the system level operating and non-operating environmental limits.

**Table 4. System environmental limits summary**

Parameter		Limits			
Temperature	Operating	ASHRAE Class A2 – Continuous Operation. 10 °C to 35 °C (50–95 °F) with the maximum rate of change not to exceed 10 °C per hour. **			
		ASHRAE Class A3 – Includes operation up to 40 °C for up to 900 hours per year. **			
		ASHRAE Class A4 – Includes operation up to 45 °C for up to 90 hours per year. **			
	Shipping	-40–70 °C (-40–158 °F)			
Altitude	Operating	Support operation up to 3050 m with ASHRAE class de-ratings.			
Humidity	Shipping	50% to 90%, non-condensing with a maximum wet bulb of 28 °C (at temperatures from 25 °C to 35 °C)			
Shock	Operating	Half sine, 2 g, 11 msec			
	Unpackaged	Trapezoidal, 25 g, velocity change is based on packaged weight			
	Packaged	ISTA (International Safe Transit Association) Test Procedure 3A 2008			
Vibration	Unpackaged	5 Hz to 500 Hz, 2.20 g RMS random			
	Packaged	ISTA (International Safe Transit Association) Test Procedure 3A 2008			
AC-DC	Voltage	90 Hz to 132 V and 180 V to 264 V			
	Frequency	47 Hz to 63 Hz			
	Source Interrupt	No loss of data for power line drop-out of 12 msec			
	Surge Non-operating and operating	Unidirectional			
	Line to earth Only	AC Leads	2.0 kV		
	I/O Leads	1.0 kV			
	DC Leads	0.5 kV			
ESD	Air Discharged	12.0 kV			
	Contact Discharge	8.0 kV			
Acoustics Sound Power Measured	Power	<300 W	≥300 W	≥600 W	≥1000 W
	Servers/Rack Mount Sound Power Level	7.0 BA	7.0 BA	7.0 BA	7.0 BA

\*\* For system configuration support limits, refer to Appendix D in this document or the Intel® Server Board S2600WF Product Family Power Budget and Thermal Configuration Tool.

### 2.13.1 Intel® Server Board Use Disclaimer

Intel® Server Boards support add-in peripherals and contain a number of high-density very large scale integrations (VLSI) and power delivery components that need adequate airflow to cool. Intel ensures through its own chassis development and testing that when Intel server building blocks are used together, the fully integrated system will meet the intended thermal requirements of these components. It is the responsibility of the system integrator who chooses not to use Intel developed server building blocks to consult vendor datasheets and operating parameters to determine the amount of airflow required for their specific application and environmental conditions. Intel Corporation cannot be held responsible if components fail or the server board does not operate correctly when used outside any of its published operating or non-operating limits.

## 2.14 System Packaging

The original Intel packaging is designed to provide protection to a fully configured system and tested to meet International Safe Transit Association (ISTA) Test Procedure 3A (2008). The packaging is also designed to be re-used for shipment after system integration has been completed.

The original packaging includes two layers of boxes – an inner box and the outer shipping box – and various protective inner packaging components. The boxes and packaging components are designed to function together as a protective packaging system. When reused, all of the original packaging material must be used, including both boxes and each inner packaging component. In addition, all inner packaging components must be reinstalled in the proper location to ensure adequate protection of the system for subsequent shipment.

---

**Note:** The design of the inner packaging components does not prevent improper placement within the packaging assembly. There is only one correct packaging assembly that allows the package to meet the ISTA Test Procedure 3A (2008) limits. See the *Intel® Server System R1000WF Product Family System Integration and Service Guide* for complete packaging assembly instructions. Failure to follow the specified packaging assembly instructions may result in damage to the system during shipment.

---

- **Outer shipping box external dimensions**
  - Length: 983 mm
  - Breadth: 577 mm
  - Height: 260 mm
- **Inner box internal dimension**
  - Length: 956 mm
  - Breadth: 550 mm
  - Height: 202 mm

**Table 5. Product weight information**

iPC	Product Type	Packaged Gross Weight (kg)	Packaged Gross Weight (lb)	Un-packaged Net Weight (kg)	Un-packaged Net Weight (lb)
R1304WFXXX	Chassis	12.57	27.65	4.265	9.38
R1208WFXXX	Chassis	13.17	28.97	4.865	10.7
R1304WFXXX	System	20.6	45.32	12.3	27.1
R1208WFXXX	System	21.42	47.12	13.12	28.86

---

**Note:** Weights of integrated systems vary depending on the final system configuration. For the 1U product family, a fully integrated un-packaged system can weigh upwards of 40 lb (18 kg). Refer to the *Intel® Server Board S2600WF Product Family Configuration Guide* for product weight information associated with each available product SKU.

---

## 3. System Power

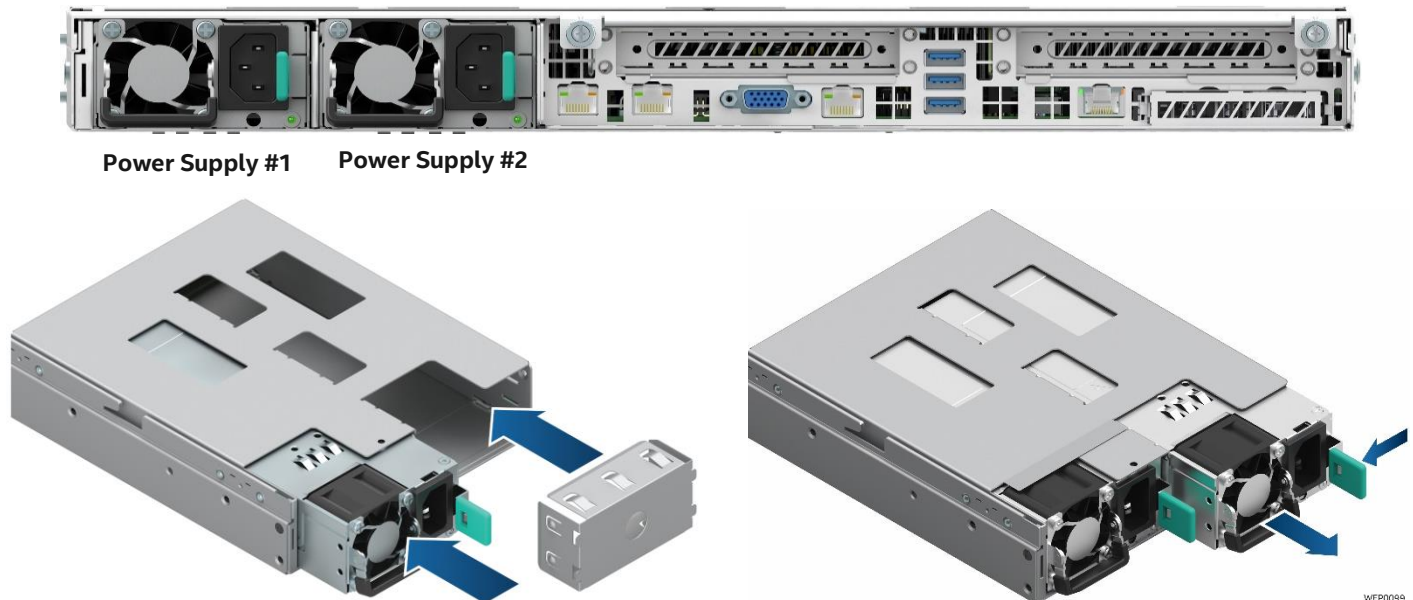
This section provides a high level overview of the features and functions related to system power.

### 3.1 Power Supply Configurations

The server system can have up to two power supply modules installed and can support the following power supply configurations: 1+0 (single power supply), 1+1 redundant power, and 2+0 combined power (non-redundant). 1+1 redundant power and 2+0 combined power configurations are automatically configured depending on the total power draw of the system. If the total system power draw exceeds the power capacity of a single power supply module, then power from the second power supply module is used. Should this occur, power redundancy is lost. In a 2+0 power configuration, total power available may be less than twice the rated power of the installed power supply modules due to the amount of heat produced with both supplies providing peak power. Should system thermal levels exceed programmed limits, platform management attempts to keep the system operational. For details, see Section 3.6 and Section 4.

**Caution:** Installing two power supply units with different wattage ratings in a system is not supported. Doing so does not provide power supply redundancy and results in multiple errors being logged by the system.

The power supplies are modular, allowing for tool-less insertion and extraction from a bay in the back of the chassis. When inserted, the card edge connector of the power supply mates blindly to a matching slot connector on the server board.



**Figure 18. Power supply module identification**

In the event of a power supply failure, redundant 1+1 power supply configurations have support for hot-swap extraction and insertion. The AC input is auto-ranging and power factor corrected.

## 3.2 Power Supply Module Options

There are three power supply options available for the Intel® Server System R1000WF Product Family:


- 1100W AC 80 Plus Platinum – iPC AXX1100PCRPS
- 1300W AC 80 Plus Titanium – iPC AXX1300TCRPS
- 750W DC 80 Plus Gold – iPC AXX750DCCRPS

### 3.2.1 Power Supply Module Efficiency


The following tables provide the required minimum efficiency level at various loading conditions. These are provided at four different load levels: 100%, 50%, 20%, and 10%.

The AC power supply efficiency is tested over an AC input voltage range of 115 VAC to 220 VAC.

**Table 6. 1100 Watt AC power supply efficiency (80 PLUS\* Platinum)**


	Loading	100% of maximum	50% of maximum	20% of maximum	10% of maximum
	Minimum Efficiency	91%	94%	90%	82%

**Table 7. 1300 Watt AC power supply efficiency (80 PLUS\* Titanium)**

	Loading	100% of maximum	50% of maximum	20% of maximum	10% of maximum
	Minimum Efficiency	91%	96%	94%	90%

The DC power supply efficiency is tested with a 53-V DC input.

**Table 8. 750 Watt DC power supply efficiency (80 PLUS\* Gold)**

	Loading	100% of maximum	50% of maximum	20% of maximum	10% of maximum
	Minimum Efficiency	88%	92%	88%	80%

### 3.2.2 Power Supply Module Mechanical Overview



1100W/1300W AC Power  
Supply Module with Dual Fan



750W DC Power Supply Module



AC Power Cable Connectors



DC Power Cable Connectors

**Figure 19. Power supply module mechanical overview**

The physical size of the 1100-W AC and 1300-W power supply enclosures is 39 mm x 74 mm x 185 mm. The power supply includes dual in-line 40 mm fans, with one mounted inside the enclosure, and the other extending outside the enclosure.

---

**Note:** The second fan protrudes from the back of the power supply bay, making the total length 213 mm front to back.

---

The power supply has a card edge output that interfaces with a 2x25 card edge connector in the system.



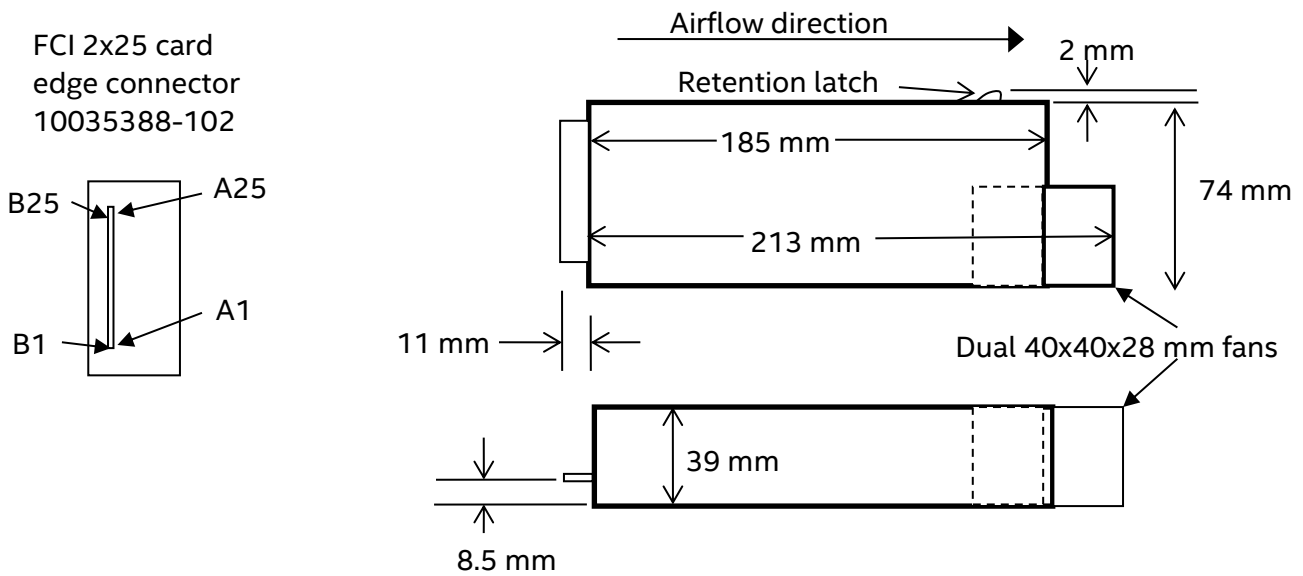


Figure 20. 1100-W AC power supply module mechanical drawing

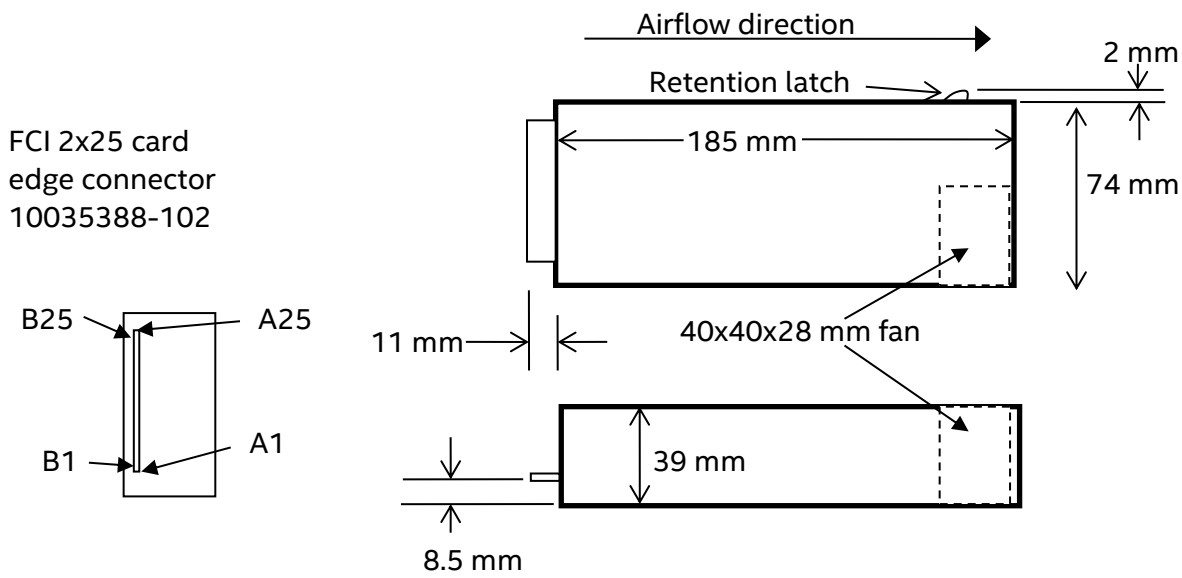


Figure 21. 1300-W AC power supply module mechanical drawing

### 3.2.3 Power Cord Specification Requirements

The AC and DC power cords used must meet the specification requirements listed in this section.

Table 9. AC power cord specifications

Cable Type	SJT
Wire Size	16 AWG
Temperature Rating	105 °C
Amperage Rating	13 A
Voltage Rating	125 V

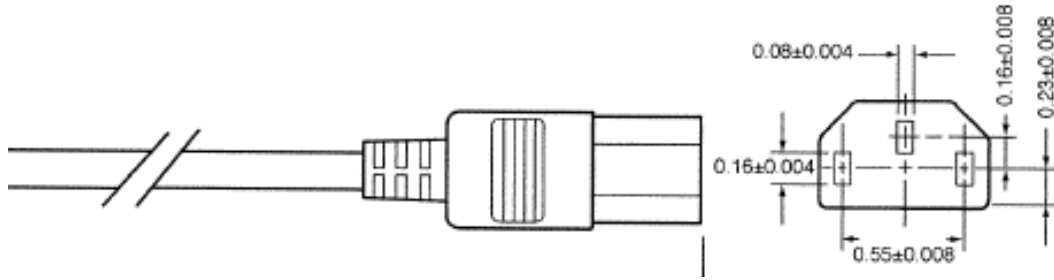


Figure 22. AC power cord specification

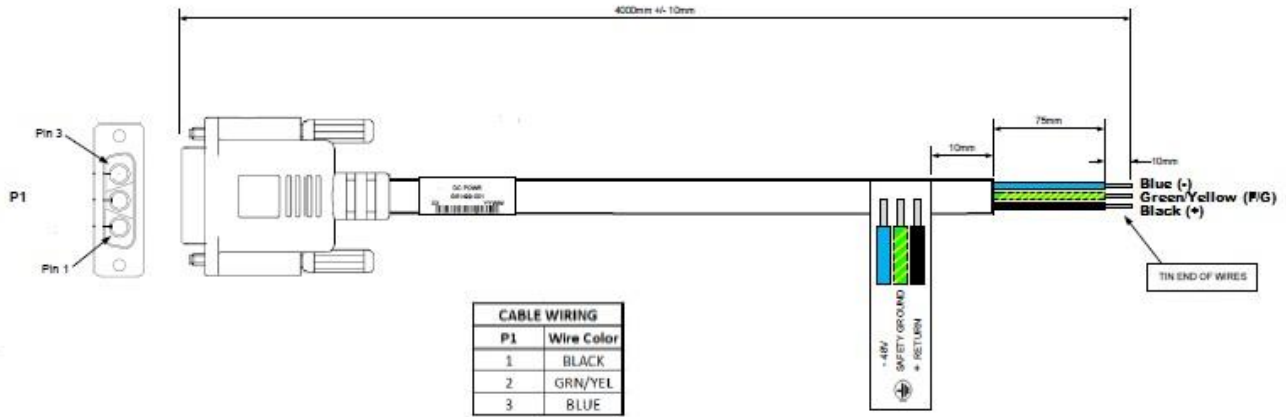


Figure 23. DC power cord specification

Table 10. DC power cable connector pinout

Pin	Definition
1	+ Return
2	Safety Ground
3	- 48V

### 3.3 AC Power Supply Input Specifications

The following sections provide the AC input specifications for systems configured with AC power supply modules.

#### 3.3.1 Power Factor

The power supply meets the power factor requirements stated in the ENERGY STAR\* Program Requirements for Computer Servers; these requirements are stated below.

**Table 11. AC power factor, 1100-W power supply**

Output Power	10% load	20% load	50% load	100% load
Power Factor	> 0.65	> 0.80	> 0.90	> 0.95

Tested at 230 VAC, 50 Hz and 60 Hz and 115 VAC, 60 Hz.

**Table 12. AC power factor, 1300-W power supply**

Output power	10% load	20% load	50% load	100% load
Power factor	> 0.90	> 0.96	> 0.98	> 0.99
Current THD	< 20%	< 10%	< 8%	< 5%

Tested at 230Vac, 50Hz

#### 3.3.2 AC Input Voltage Specification

The power supply operates within all specified limits over the following input voltage range. Harmonic distortion of up to 10% of the rated line voltage does not cause the power supply to go out of specified limits. Application of an input voltage below 85 VAC does not damage the power supply, including a blown fuse.

**Table 13. AC input voltage range, 1100 W power supply**

Parameter	MIN	Rated	VMAX	Startup VAC	Power Off VAC
Voltage (110)	90 Vrms	100–127 Vrms	140 Vrms	85 VAC +/-4 VAC	74 VAC +/-5 VAC
Voltage (220)	180 Vrms	200–240 Vrms	264 Vrms		
Frequency	47 Hz	50/60	63 Hz		

**Table 14. AC input voltage range, 1300 W power supply**

Parameter	MIN	Rated	VMAX	Startup VAC	Power Off VAC
Voltage (110)	90 Vrms	100–127 Vrms	140 Vrms	85VAC +/-4VAC	74VAC +/-5VAC
Voltage (220)	180 Vrms	200–240 Vrms	264 Vrms		
Frequency	47 Hz	50/60	63 Hz		

Maximum input current at low input voltage range is measured at 90 VAC, at max load.

Maximum input current at high input voltage range is measured at 180 VAC, at max load.

This requirement is not to be used for determining agency input current markings.

#### 3.3.3 AC Line Isolation Requirements

The power supply meets all safety agency requirements for dielectric strength. Transformer isolation between primary and secondary windings must comply with the 3000 VAC (4242 VDC) dielectric strength criteria. If the working voltage between primary and secondary dictates a higher dielectric strength test voltage the highest test voltage should be used. In addition, the insulation system must comply with

reinforced insulation per safety standard IEC 950. Separation between the primary and secondary circuits, and primary to ground circuits, must comply with the IEC 950 spacing requirements.

### 3.3.4 AC Line Dropout/Holdup

An AC line dropout is defined to be when the AC input drops to 0 VAC at any phase of the AC line for any length of time. During an AC dropout, the power supply meets dynamic voltage regulation requirements. An AC line dropout of any duration does not cause tripping of control signals or protection circuits. If the AC dropout lasts longer than the holdup time, the power supply recovers and meets all turn on requirements. The power supply meets the AC dropout requirement over rated AC voltages and frequencies. A dropout of the AC line for any duration does not damage the power supply.

**Table 15. AC line holdup time, 1100-W power supply**

Loading	Holdup time
70%	10msec

**Table 12+1. AC line holdup time, 1300-W power supply**

Loading during AC dropout / holdup	Holdup time / Dropout duration
0% to 70% of rated load	10msec

#### 3.3.4.1 AC Line 12 VSB Holdup

The 12 VSB output voltage stays in regulation under its full load (static or dynamic) during an AC dropout of 70 msec minimum (12 VSB holdup time) whether the power supply is in an ON or OFF state (PSON asserted or deasserted).

### 3.3.5 AC Line Fuse

The power supply has one line fused in the single line fuse on the line (hot) wire of the AC input. The line fusing is acceptable for all safety agency requirements. The input fuse shall be a slow blow type. AC inrush current does not cause the AC line fuse to blow under any conditions. All protection circuits in the power supply do not cause the AC fuse to blow unless a component in the power supply has failed. This includes DC output load short conditions.

### 3.3.6 AC Inrush

AC line inrush current does not exceed 55 A peak, for up to one-quarter of the AC cycle, after which the input current is no more than the specified maximum input current. The peak inrush current is less than the ratings of its critical components (including input fuse, bulk rectifiers, and surge limiting device).

The power supply meets the inrush requirements for any rated AC voltage during turn on at any phase of AC voltage, during a single cycle AC dropout condition, upon recovery after AC dropout of any duration, and over the specified temperature range ( $T_{op}$ ).

### 3.3.7 AC Line Transient Specification

AC line transient conditions are defined as “sag” and “surge” conditions. “Sag” conditions, also commonly referred to as “brownout,” are defined as the AC line voltage dropping below nominal voltage conditions. “Surge” is defined as conditions when the AC line voltage rises above nominal voltage.

The power supply meets the requirements under the following AC line sag and surge conditions.

**Table 16. AC line sag transient performance (10 sec interval between each sagging)**

Duration	Sag	Operating AC Voltage	Line Frequency	Performance Criteria
0 to 1/2 AC cycle	95%	Nominal AC Voltage ranges	50/60Hz	No loss of function or performance
> 1 AC cycle	>30%	Nominal AC Voltage ranges	50/60Hz	Loss of function acceptable, self-recoverable

**Table 17. AC line surge transient performance**

Duration	Surge	Operating AC Voltage	Line Frequency	Performance Criteria
Continuous	10%	Nominal AC Voltages	50/60 Hz	No loss of function or performance
0 to ½ AC cycle	30%	Mid-point of nominal AC Voltages	50/60 Hz	No loss of function or performance

### 3.3.8 DC Output Specification

The following table defines the minimum power and current ratings. The power supply 1100 W must meet both static and dynamic voltage regulation requirements for all conditions.

**Table 18. Maximum load ratings**

Parameter	VAC	Min	Max. Continuous	20 sec Peak	10 msec Peak	100 µsec Peak	Unit
12 V main	200-240VAC	0.0	108	120	130	150 5	A
12 V main	100-127VAC	0.0	62	70	80	NA	A
12 Vstby		0.0	2.1	2.4	NA	NA	A

### 3.3.9 Susceptibility Requirements

The power supply meets the following electrical immunity requirements when connected to a cage with an external EMI filter that meets the criteria defined in the SSI document *EPS Power Supply Specification*. For further information on Intel standards, request a copy of the *Intel Environmental Standards Handbook*.

**Table 19. Performance criteria**

Level	Description
A	The apparatus continues to operate as intended. No degradation of performance.
B	The apparatus shall continue to operate as intended. No degradation of performance beyond specification limits.
C	Temporary loss of function is allowed provided the function is self-recoverable or can be restored by the operation of the controls.

### 3.3.10 Electrostatic Discharge Susceptibility

The power supply complies with the limits defined in EN 55024: 1998/A1: 2001/A2: 2003 using the IEC 61000-4-2: Edition 1.2: 2001-04 test standard and performance criteria B defined in Annex B of CISPR 24.

### 3.3.11 Fast Transient/Burst

The power supply complies with the limits defined in EN55024: 1998/A1: 2001/A2: 2003 using the IEC 61000-4-4: Second edition: 2004-07 test standard and performance criteria B defined in Annex B of CISPR 24.

### 3.3.12 Radiated Immunity

The power supply complies with the limits defined in EN55024: 1998/A1: 2001/A2: 2003 using the IEC 61000-4-3: Edition 2.1: 2002-09 test standard and performance criteria A defined in Annex B of CISPR 24.

### 3.3.13 Surge Immunity

The power supply is tested with the system for immunity to the following for each power supply option:

- **1100-W Power Supply** – AC unidirectional wave; 2.6 kV line to ground and 1.3 kV line to line, per EN 55024: 1998/A1: 2001/A2: 2003, EN 61000-4-5: Edition 1.1:2001-04.
- **1300-W Power Supply** – AC Unidirectional wave; 2kV line to ground and 1kV line to line, per EN 55024: 1998/A1: 2001/A2: 2003, EN 61000-4-5: Edition 1.1:2001-04.

The pass criteria include the following: No unsafe operation is allowed under any condition; all power supply output voltage levels to stay within proper specification levels; No change in operating state or loss of data during and after the test profile; No component damage under any condition.

The power supply complies with the limits defined in EN55024: 1998/A1: 2001/A2: 2003 using the IEC 61000-4-5: Edition 1.1:2001-04 test standard and performance criteria B defined in Annex B of CISPR 24.

### 3.3.14 Power Recovery

The power supply recovers automatically after an AC power failure. AC power failure is defined to be any loss of AC power that exceeds the dropout criteria.

### 3.3.15 Voltage Interruptions

The power supply complies with the limits defined in EN55024: 1998/A1: 2001/A2: 2003 using the IEC 61000-4-11: Second Edition: 2004-03 test standard and performance criteria C defined in Annex B of CISPR 24.

### 3.3.16 Protection Circuits

Protection circuits inside the power supply cause only the power supply's main outputs to shut down. If the power supply latches off due to a protection circuit tripping, an AC cycle OFF for 15 seconds and a PSON# cycle HIGH for one second reset the power supply.

#### 3.3.16.1 Overcurrent Protection

The power supply has current limit to prevent the outputs from exceeding the values shown in Table 20 and Table 17+1. If the current limits are exceeded, the power supply shuts down and latches off. The latch is cleared by toggling the PSON# signal or by an AC power interruption. The power supply is not damaged from repeated power cycling in this condition. 12 VSB is auto-recovered after removing the overcurrent protection limit.

**Table 20. Over current protection, 1100-W power supply**

Output Voltage	Input Voltage Range	Over Current Limits
+12 V	90–264 VAC	120 A min/132 A max
	Trip delay	50 msec min
12 VSB	90–264 VAC	2.5 A min/3.5 A max

**Table 17+1. Over current protection, 1300-W power supply**

Output Voltage	Input Voltage Range	Over Current Limits	OCP Delay
+12V	180 – 264VAC	132A min / 138A max	50 msec min / 200 msec max
		152A min / 160A max	5 msec min / 20 msec max
+12V	90 – 140VAC	72A min / 77A max	50 msec min / 200 msec max
	90 – 140VAC	103A min / 107A max	5 msec min / 20 msec
12VSB	90 – 264VAC	2.5A min / 3.5A max	5 msec min / 20 msec

#### 3.3.16.2 Over Voltage Protection (OVP)

The power supply over voltage protection is locally sensed. The power supply shuts down and latches off after an over voltage condition occurs. This latch is cleared by an AC power interruption. The values are measured at the output of the power supply's connectors. The voltage never exceeds the maximum levels when measured at the power connectors of the power supply connector during any single point of fail. The voltage never trips any lower than the minimum levels when measured at the power connector. 12 VSB is auto-recovered after removing OVP limit.

**Table 21. Over voltage protection (OVP) limits, 1100-W power supply**

Output Voltage	Minimum (V)	Maximum (V)
+12V	13.5	14.5
+12VSB	13.5	14.5

### 3.3.16.3 Over Temperature Protection (OTP)

The power supply is protected against over temperature conditions caused by loss of fan cooling or excessive ambient temperature. In an OTP condition, the PSU shuts down. OT warning SMBAlert# assertion always precedes the OTP shutdown. When the power supply temperature drops to within specified limits, the power supply restores power automatically, while the 12 VSB always remains on. The OTP circuit has built-in margin such that the power supply does not oscillate on and off due to temperature recovering condition. The OTP trip temperature level is at least 5 °C higher than SMBAlert over temperature warning threshold level.

### 3.3.17 Power Supply Status LED

There is a single bi-color LED to indicate power supply status. The LED operation is defined in Table 22.

**Table 22. LED indicators**

Power Supply Condition	LED State
Output ON and OK	Solid green
No AC power to all power supplies	Off
AC present/Only 12 VSB on (PS off) or PS in cold redundant state	1 Hz blinking green
AC cord unplugged or AC power lost; with a second power supply in parallel still with AC input power	Solid amber
Power supply warning events where the power supply continues to operate; high temp, high power, high current, slow fan	1 Hz blinking amber
Power supply critical event causing a shutdown; failure, OCP, OVP, fan fail	Solid amber
Power supply FW updating	2 Hz blinking green

## 3.4 DC Power Supply Input Specifications (iPC – AXX750DCCRPS)

The following sections provide the DC input specifications for systems configured with DC power supply modules.

---

**Note:** Product safety regulations pertaining to the use of DC power supplies require that chassis grounding studs be used for all DC power supply configurations. In the event that chassis grounding studs are not available on a given server chassis, systems must be configured with two DC power supplies, each connected to separate ground wires while the system is operational.

---

### 3.4.1 DC Input Voltage

The power supply must operate within all specified limits over the following input voltage range.

**Table 23. DC input rating**

Parameter	Minimum	Rated	Maximum
DC Voltage	-40.5 VDC	-48 VDC/-60 VDC	-75 VDC
Input Current	24 A		12.5 A

### 3.4.2 DC Input Fuse

The power supply should have the -48 VDC input fused. The fusing shall be acceptable for all safety agency requirements. DC inrush current shall not cause the fuse to blow under any conditions. No protection circuits in the power supply shall cause the DC fuse to blow unless a component in the power supply has failed. This includes DC output load short conditions.

### 3.4.3 DC Inrush Current

Maximum inrush current from power-on shall be limited to a level below the surge rating of the input line cable; input diodes, fuse, and EMI filter components. To allow multiple power cycling events and DC line transient conditions max  $I^2t$  value shall not exceed 20% of the fuse max rating. Repetitive ON/OFF cycling of the DC input line voltage should not damage the power supply or cause the input fuse to blow.

### 3.4.4 DC Input under Voltage

The power supply shall contain protection circuitry (under-voltage lock-out) such that the application of an input voltage below the specified minimum specified, shall not damage (overstress) the power supply unit (due to over-heating or otherwise).

### 3.4.5 DC Holdup Time and Dropout

**Table 24. DC holdup time**

Loading	Holdup Time
750 W (100%)	0.2 msec

During a DC dropout of 0.2 msec or less the power supply must meet dynamic voltage regulation requirements for every rated load condition. A DC line dropout of 0.2 msec or less shall not cause tripping of control signals or protection circuits. Repeated every ten seconds starting at the minimum input voltage, DC line dropout shall not damage the power supply under any specified load conditions. The PWOK signal shall not go to a low state under these conditions. DC dropout transients in excess of 0.2 msec may cause shutdown of the power supply or out of regulation conditions, but shall not damage the power supply. The power supply should recover and meet all turn on requirements for DC dropouts that last longer than 0.2 msec. The power supply must meet the DC dropout requirement over rated DC voltages and output loading conditions.

### 3.4.6 DC Line Surge Voltages (Line Transients)

The power supply should demonstrate tolerance for transients in the input DC power line caused by switching or lightning. The power supply shall be primarily tested and must be compliant with the requirements of EN61000-4-5: "Electrical Fast transients / Burst Requirements and Surge Immunity Requirements" for surge withstand capability. The test voltage surge levels are to be 500Vpk for each Line to Primary Earth Ground test (none required between the L1 and L2). The exact description can be found in *Intel Environmental Standards Handbook 2001*.



**Table 25. Line voltage transient limits**

Duration	Slope/Rate	Output	Performance Criteria
200 µsec max	-48 V → -30 V w/ +2 V/µs	Rated DC voltages	No loss of function or performance
	-30 V → -48 V w/ -2 V/µs	Rated DC voltages	No loss of function or performance

### 3.4.7 Susceptibility Requirements

The power supply shall meet the following electrical immunity requirements when connected to a cage with an external EMI filter that meets the criteria defined in the SSI document *EPS Power Supply Specification*. For further information on Intel standards, request a copy of the *Intel Environmental Standards Handbook*.

**Table 26. Performance criteria**

Level	Description
A	The apparatus shall continue to operate as intended. No degradation of performance.
B	The apparatus shall continue to operate as intended. No degradation of performance beyond specifications limits.
C	Temporary loss of function is allowed provided the function is self-recoverable or can be restored by the operation of the controls.

#### 3.4.7.1 Electrostatic Discharge Susceptibility

The power supply shall comply with the limits defined in EN 55024: 1998 using the IEC 61000-4-2:1995 test standard and performance criteria B defined in Annex B of CISPR 24. Limits shall comply with those specified in the *Intel Environmental Standards Handbook*.

#### 3.4.7.2 Fast Transient/Burst

The power supply shall comply with the limits defined in EN55024: 1998 using the IEC 61000-4-4:1995 test standard and performance criteria B defined in Annex B of CISPR 24. Limits shall comply with those specified in the *Intel Environmental Standards Handbook*.

#### 3.4.7.3 Radiated Immunity

The power supply shall comply with the limits defined in EN55024: 1998 using the IEC 61000-4-3:1995 test standard and performance criteria A defined in Annex B of CISPR 24. Limits shall comply with those specified in the *Intel Environmental Standards Handbook*. Additionally, the power supply must comply with field strength requirements specified in GR 1089 (10 V/m).

#### 3.4.7.4 Surge Immunity

The power supply shall be tested with the system for surge immunity, per EN 55024:1998, EN 61000-4-5:1995 and ANSI C62.45: 1992.

The pass criteria include the following: No unsafe operation is allowed under any condition; all power supply output voltage levels to stay within proper specification levels; No change in operating state or loss of data during and after the test profile; No component damage under any condition.

The power supply shall comply with the limits defined in EN55024: 1998 using the IEC 61000-4-5:1995 test standard and performance criteria B defined in Annex B of CISPR 24. Limits shall comply with those specified in the *Intel Environmental Standards Handbook*.

### 3.4.8 Protection Circuits

Protection circuits inside the power supply shall cause only the power supply's main outputs to shut down. If the power supply latches off due to a protection circuit tripping, a DC cycle OFF for 15 sec and a PSON# cycle HIGH for 1 sec shall be able to reset the power supply.

### 3.4.8.1 Over Current Protections (OCP)

The power supply shall have current limit to prevent the outputs from exceeding the values shown in Table 27. If the current limits are exceeded, the power supply shall shut down and latch off. The latch will be cleared by toggling the PSON# signal or by a DC power interruption. The power supply shall not be damaged from repeated power cycling in this condition. 12VSB will be auto-recovered after removing OCP limit.

**Table 27. Over current protection**

Output Voltage	Input Voltage Range	Over Current Limits
+12V		72 A min/78 A max
12VSB		2.5 A min/3.5 A max

### 3.4.8.2 Over Voltage Protection (OVP)

The power supply over voltage protection shall be locally sensed. The power supply shall shut down and latch off after an over voltage condition occurs. This latch shall be cleared by toggling the PSON# signal or by a DC power interruption. The values are measured at the output of the power supply's connectors. The voltage shall never exceed the maximum levels when measured at the power supply connector during any single point of fail. The voltage shall never trip any lower than the minimum levels when measured at the power connector. 12 VSB will be auto-recovered after removing OVP limit.

**Table 28. Over voltage protection limits**

Output Voltage	Minimum (V)	Maximum (V)
+12 V	13.3	14.5
+12 VSB	13.3	14.5

### 3.4.8.3 Over Temperature Protection (OTP)

The power supply will be protected against over temperature conditions caused by loss of fan cooling or excessive ambient temperature. In an OTP condition, the PSU will shut down. When the power supply temperature drops to within specified limits, the power supply shall restore power automatically, while the 12 VSB always remains on. The OTP circuit must have built in margin such that the power supply will not oscillate on and off during a temperature recovering condition. The OTP trip level shall have a minimum of 4 °C of ambient temperature margin.

## 3.5 Cold Redundancy Support

The power supplies support cold redundancy allowing them to go into a low-power state (that is, a cold redundant state) in order to provide increased power usage efficiency when system loads are such that both power supplies are not needed. When the power subsystem is in cold redundant mode, only the needed power supply to support the best power delivery efficiency is ON. Any additional power supplies, including the redundant power supply, is in cold standby state.

Each power supply has an additional signal that is dedicated to supporting cold redundancy: CR\_BUS. This signal is a common bus between all power supplies in the system. CR\_BUS is asserted when there is a fault in any power supply or the power supplies' output voltages fall below the V<sub>fault</sub> threshold. Asserting the CR\_BUS signal causes all power supplies in cold standby state to power ON.

Enabling power supplies to maintain optimum efficiency is achieved by looking at the load share bus voltage and comparing it to a programmed voltage level via a PMBus\* command.

Whenever there is no active power supply on the cold redundancy bus driving a HIGH level on the bus, all power supplies are ON no matter their defined cold redundant roll (active or cold standby). This guarantees

that incorrect programming of the cold redundancy states of the power supply will never cause the power subsystem to shut down or become over loaded. The default state of the power subsystem is all power supplies ON. There needs to be at least one power supply in cold redundant active state or standard redundant state to allow the cold standby state power supplies to go into cold standby state.

### 3.5.1 Powering on Cold Standby Supplies to Maintain Best Efficiency

Power supplies in cold standby state shall monitor the shared voltage level of the load share signal to sense when it needs to power on. Depending upon which position (1, 2, or 3) the system defines that power supply to be in, the cold standby configuration slightly changes the load share threshold that the power supply shall power on at.

**Table 29. Example load share threshold for activating supplies**

State	Enable Threshold for VCR_ON_EN	Disable Threshold for VCR_ON_DIS	CR_BUS De-Asserted/ Asserted States
<b>Standard Redundancy</b>	NA; Ignore dc/dc_active# signal; power supply is always ON		OK = High, Fault = Low
<b>Cold Redundant Active</b>	NA; Ignore dc/dc_active# signal; power supply is always ON		OK = High, Fault = Low
<b>Cold Standby 1 (02h)</b>	3.2 V (40% of max)	$3.2 \text{ V} \times 0.5 \times 0.9 = 1.44 \text{ V}$	OK = Open, Fault = Low
<b>Cold Standby 2 (03h)</b>	5.0 V (62% of max)	$5.0 \text{ V} \times 0.67 \times 0.9 = 3.01 \text{ V}$	OK = Open, Fault = Low
<b>Cold Standby 3 (04h)</b>	6.7 V (84% of max)	$6.7 \text{ V} \times 0.75 \times 0.9 = 4.52 \text{ V}$	OK = Open, Fault = Low

#### Notes:

Maximum load share voltage is 8.0 V at 100% of rated output power.

Load share bus thresholds are examples. For a given power supply, these will be customized to maintain the best efficiency curve for that specific model.

### 3.5.2 Powering on Cold Standby Supplies during a Fault or Overcurrent Condition

When an active power supply asserts its CR\_BUS signal (pulling it low), all parallel power supplies in cold standby mode will power on within 100 µsec.

### 3.5.3 BMC Requirements

The BMC uses the `Cold_Redundancy_Config` command to define and configure the power supply's role in cold redundancy and to turn on/off cold redundancy.

To allow for equal loading over the life time of installed power supplies, the BMC schedules a rolling reconfiguration of installed power supplies so that each alternates between being the "Active" power supply and the "Cold Stby" power supply.

Events that trigger a re-configuration of the power supplies using the `Cold_Redundancy_Config` command are listed below.

- AC power ON
- PSON power ON
- Power supply failure
- Power supply inserted into system

### 3.5.4 Power Supply Turn on Function

Powering on and off of the cold standby power supplies is only controlled by each PSU sensing the Vshare bus. Once a power supply turns on after crossing the enable threshold, it lowers itself to the disable threshold. The system defines the position of each power supply in the cold redundant operation. It does this each time the system is powered on, a power supply fails, or a power supply is added to the system.

The system is relied upon to tell each power supply where it resides in the cold redundancy scheme.

### 3.6 Closed Loop System Throttling (CLST)

The server system has support for Closed Loop System Throttling (CLST) which prevents the system from crashing if a power supply module is overloaded or over heats. Should system power reach a pre-programmed power limit, CLST throttles system memory and/or processors to reduce power. System performance is impacted should this occur.

### 3.7 Smart Ride Through (SmaRT)

The server system has support for Smart Ride Through Throttling (SmaRT) which increases the reliability for a system operating in a heavy power load condition and to remain operational during an AC line dropout event. For power supply hold up time requirements for AC line dropout events, see Section 3.3.4.

When AC voltage is too low, a fast AC loss detection circuit inside each installed power supply asserts an SMBALERT# signal to initiate a throttle condition in the system. System throttling reduces the bandwidth to both system memory and CPUs, which in turn reduces the power load during the AC line drop out event

### 3.8 Server Board Power Connectors

The server board provides several connectors to provide power to various system options. This section provides the pinout definition and a brief usage description for each.

#### 3.8.1 Power Supply Module Card Edge Connector

Each power supply module has a single 2x25 card edge output connection that plugs directly into a matching slot connector on the server board. The connector provides both power and communication signals to the server board. The following table defines the connector pinout.

**Table 30. Power supply module output power connector pinout**

Pin#	Name	Pin#	Name
A1	GND	B1	GND
A2	GND	B2	GND
A3	GND	B3	GND
A4	GND	B4	GND
A5	GND	B5	GND
A6	GND	B6	GND
A7	GND	B7	GND
A8	GND	B8	GND
A9	GND	B9	GND
A10	+12V	B10	+12V
A11	+12V	B11	+12V
A12	+12V	B12	+12V
A13	+12V	B13	+12V
A14	+12V	B14	+12V
A15	+12V	B15	+12V
A16	+12V	B16	+12V
A17	+12V	B17	+12V
A18	+12V	B18	+12V
A19	PMBus SDA	B19	A0 (SMBus address)
A20	PMBus SCL	B20	A1 (SMBus address)
A21	PSON	B21	12 VSB
A22	SMBAlert#	B22	Cold redundancy bus

Pin#	Name	Pin#	Name
A23	Return sense	B23	12V load share bus
A24	+12V remote sense	B24	No connect
A25	PWOK	B25	Compatibility check pin

### 3.8.2 Hot Swap Backplane Power Connector

The server board includes one white 2x6-pin power connector that is used to provide power for the hot swap backplanes mounted in the front of the chassis only. On the server board, this connector is labeled as “HSBP PWR”. The power for this connector is routed from two separate 12 V power rails, each capable of supporting a current limit of 18 A. The following table provides the pinout for this connector.

**Table 31. Hot swap backplane power connector pinout (“HSBP PWR”)**

Signal Description	Pin#	Pin#	Signal Description
GND	1	7	P12V_240VA3
GND	2	8	P12V_240VA3
GND	3	9	P12V_240VA2
GND	4	10	P12V_240VA2
GND	5	11	P12V_240VA1
GND	6	12	P12V_240VA1

### 3.8.3 Peripheral Power Connector

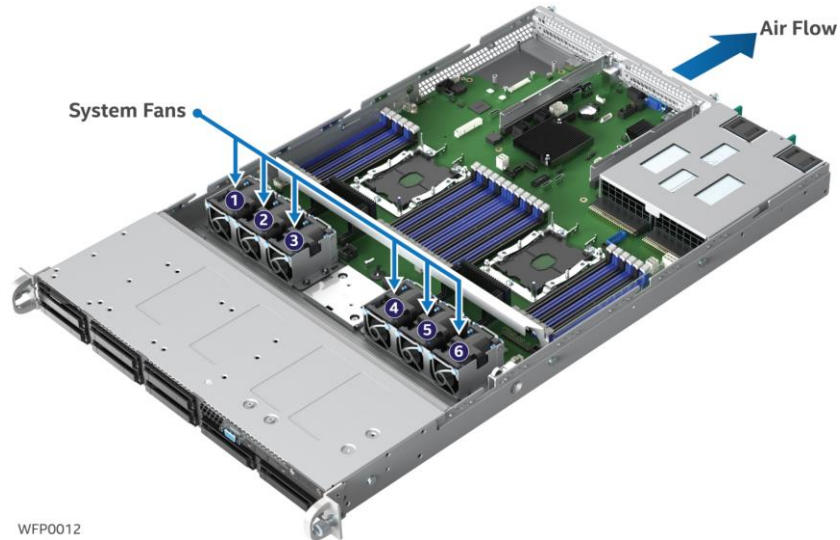
The server board includes one brown 2x3-pin power connector intended to provide power to various possible peripheral options including: solid state devices (SSDs) mounted to the top side of the air duct or to the rear mounted two drive backplane accessory option. On the server board, this connector is labeled as “Peripheral PWR”. The following table provides the pinout for this connector.

**Table 32. Peripheral drive power connector pinout (“Peripheral PWR”)**

Pin	Signal Name	Pin	Signal Name
1	P5V	4	P12V
2	P5V	5	P3V3
3	GND	6	GND

## 4. Thermal Management

The fully integrated system is designed to operate at external ambient temperatures of 10–35 °C with limited excursion based operation up to 45 °C, as specified in Table 4. Working with integrated platform management, several features within the system are designed to move air in a front to back direction, through the system and over critical components to prevent them from overheating and allow the system to operate with best performance.



**Figure 24. System airflow and fan identification**

The following tables provide airflow data associated with the different system models within this 1U product family and are provided for reference purposes only. The data was derived from actual wind tunnel test methods and measurements using fully configured (worst case) system configurations. Lesser system configurations may produce slightly different data results. In addition, the CFM data provided using server management utilities that use platform sensor data may vary slightly from the data listed in the tables.

**Table 33. System volumetric airflow, Intel® Server System R1304WFxxx**

System Fan	PSU Fan	Total Airflow (CFM)
100%	Auto	85.6
80%	Auto	67.7
60%	Auto	48.9
40%	Auto	31.6
20%	Auto	13.6
100%	100%	89.1

**Table 34. System volumetric airflow, Intel® Server System R1208WFxxx**

System Fan	PSU Fan	Total Airflow (CFM)
100%	Auto	89.0
80%	Auto	69.6
60%	Auto	50.8
40%	Auto	32.6
20%	Auto	13.8
100%	100%	92.6

The Intel® Server System R1000WF product family supports short-term, excursion-based, operation up to 45 °C (ASHRAE A4) with limited performance impact. The configuration requirements and limitations are described in the configuration matrix found in Appendix D of this document or in the Intel® S2600WF Product Family Power Budget and Thermal Configuration Tool available as a download online at <http://www.intel.com/support>.

The installation and functionality of several system components are used to maintain system thermals. They include six managed 40 mm dual rotor system fans, fans integrated into each installed power supply module, an air duct, populated drive carriers, populated DIMM slots, and installed CPU heatsinks. Drive carriers can be populated with a storage device (SSD or HDD) or supplied drive blank. In addition, it may be necessary to have specific DIMM slots populated with DIMMs or supplied DIMM blanks. System configurations that require population of specific DIMM slots ship from Intel with DIMM blanks preinstalled. Preinstalled DIMM blanks should only be removed when installing a memory module in its place. Chassis only products include DIMM blanks separately in the accessory kit and must be installed in the appropriate DIMM slot locations as defined in the following section.

## 4.1 Thermal Operation and Configuration Requirements

To keep the system operating within supported maximum thermal limits, the system must meet the following operating and configuration guidelines:

- The system is designed to sustain operations at an ambient temperature of up to 35 °C (ASHRAE Class A2) with short term excursion based operation up to 45 °C (ASHRAE Class A4).
- The system can operate up to 40 °C (ASHRAE Class A3) for up to 900 hours per year.
- The system can operate up to 45 °C (ASHRAE Class A4) for up to 90 hours per year.
- System performance may be impacted when operating within the extended operating temperature range.
- There is no long term system reliability impact when operating at the extended temperature range within the documented limits.

Specific configuration requirements and limitations are documented in the configuration matrix found in Appendix D of this document or in the Intel® Server Board S2600WF product family Power Budget and Thermal Configuration Tool, available as a download online at <http://www.intel.com/support>.

The CPU-1 processor and CPU heat sink must be installed first. The CPU-2 heat sink must be installed at all times, with or without a processor installed.

Thermally, a system supporting fan redundancy can support the following PCI add-in cards when the system is operating at up to a maximum operating ambient temperature of 35 °C (ASHRAE Class 2).

- Add-in cards with a minimum 300 LFM (1.5 m/s) airflow requirement or lower can be installed in available add-in card slots in riser card #1 and riser card #2.
- Add-in cards with an airflow requirement greater than 300 LFM cannot be supported in any PCIe slot on any riser.

---

**Note:** Most PCI cards have cooling requirements of airflow up to 100 LFM (0.5 m/s). Some of the more difficult to cool cards have airflow requirements of up to 300 LFM (1.5 m/s) or higher. System integrators should verify PCI add-in card airflow requirements from vendor specifications when integrating add-in cards into the system.

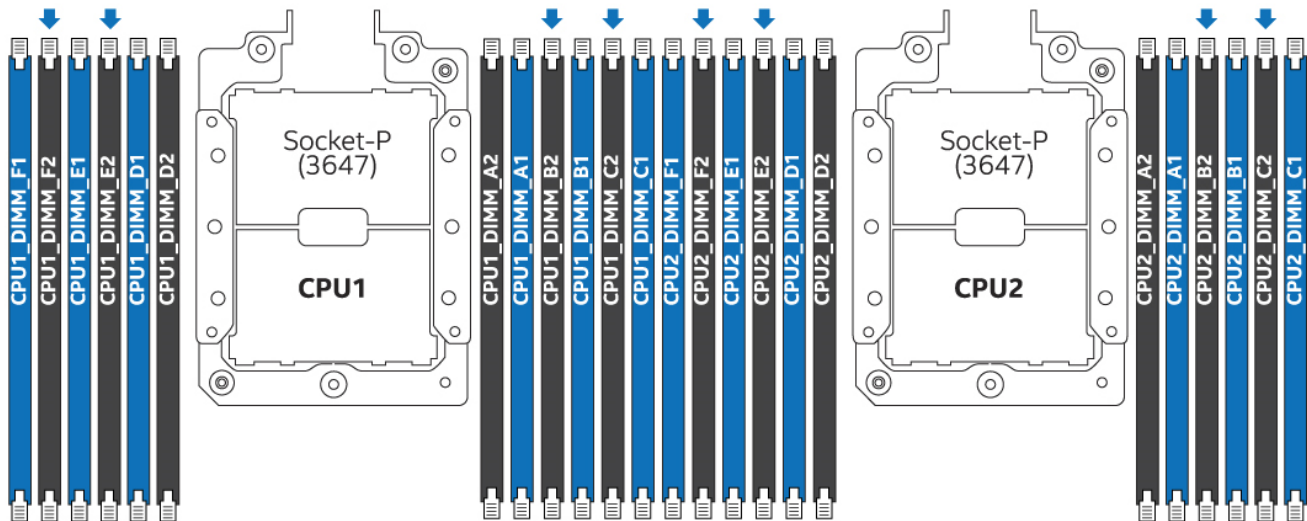
---

### 4.1.1 Memory Slot Population Requirements

System thermal requirements dictate that specific airflow be maintained over or between critical system components. To ensure that proper airflow is achieved, specific memory slots must be populated with a

DIMM or factory installed DIMM blank while the system is in operation. Figure 25 identifies the memory slots, identified with an arrow, which must be populated in all 1U system configurations.

**NOTE:** To maintain system thermals for all 1U system configurations while the system is operational, DIMM slots identified with ↓ must be populated with a DIMM or supplied DIMM blank



**Figure 25. System DIMM population layout**

The following memory population rules apply when installing DIMMs:

- DIMM population rules require that DIMMs within a channel be populated starting with the blue DIMM slot or DIMM farthest from the processor in a “fill-farthest” approach.
- When only one DIMM is used for a given memory channel, it must be populated in the BLUE DIMM slot (furthest from the CPU).
- Mixing of DDR4 DIMM types (RDIMM, LRDIMM, 3DS RDIMM, 3DS, LRDIMM) within a channel socket or across sockets produces a Fatal Error Halt during memory initialization.
- Mixing DIMMs of different frequencies and latencies is not supported within or across processor sockets. If a mixed configuration is encountered, the BIOS will attempt to operate at the highest common frequency and the lowest latency possible.
- When populating a quad-rank DIMM with a single- or dual-rank DIMM in the same channel, the quad-rank DIMM must be populated farthest from the processor. Intel MRC checks for correct DIMM placement. A maximum of eight logical ranks can be used on any one channel, as well as a maximum of ten physical ranks loaded on a channel.
- The memory slots associated with a given processor are unavailable if the corresponding processor socket is not populated.
- A processor may be installed without populating the associated memory slots, provided a second processor is installed with associated memory. In this case, the memory is shared by the processors. However, the platform suffers performance degradation and latency due to the remote memory.
- Processor sockets are self-contained and autonomous. However, all memory subsystem support (such as Memory RAS, Error Management) in the BIOS setup are applied commonly across processor sockets.
- For multiple DIMMs per channel:
  - For RDIMM, LRDIMM, 3DS RDIMM, and 3DS LRDIMM, always populate DIMMs with higher electrical loading in slot1, followed by slot 2.

**Note:** For full DIMM population rules that apply only to the Intel® persistent memory module, refer to the *Intel® Server Board S2600WF Product Family Technical Product Specification*.



## 4.2 Intel® DDR4 DIMM Support Disclaimer

Intel validates and will only provide support for system configurations where all installed DDR4 DIMMs have matching “Identical” or “Like” attributes. See Table 35. A system configured concurrently with DDR4 DIMMs from different vendors will be supported by Intel if all other DDR4 “Like” DIMM attributes match.

Intel does not perform system validation testing nor will it provide support for system configurations where all populated DDR4 DIMMs do not have matching “Like” DIMM attributes as listed in Table 35.

Intel will only provide support for Intel® server systems configured with DDR4 DIMMs that have been validated by Intel and are listed on Intel’s Tested Memory list for the given Intel server product family.

Intel configures and ships pre-integrated L9 server systems. All DDR4 DIMMs within a given L9 server system as shipped by Intel will be identical. All installed DIMMs will have matching attributes as those listed in the “Identical” DDR4 DIMM4 Attributes column in Table 35.

When purchasing more than one integrated L9 server system with the same configuration from Intel, Intel reserves the right to use “Like” DIMMs between server systems. At a minimum “Like” DIMMs will have matching DIMM attributes as listed in the table below. However, the DIMM model #, revision #, or vendor may be different.

For warranty replacement, Intel will make every effort to ship back an exact match to the one returned. However, Intel may ship back a validated “Like” DIMM. A “Like” DIMM may be from the same vendor but may not be the same revision # or model #, or it may be an Intel validated DIMM from a different vendor. At a minimum, all “Like” DIMMs shipped from Intel will match attributes of the original part according to the definition of “Like” DIMMs in the following table.

**Table 35. DDR4 DIMM Attributes Table for “Identical” and “Like” DIMMs**

<ul style="list-style-type: none"> <li>• DDR4 DIMMs are considered “Identical” when ALL listed attributes between the DIMMs match.</li> <li>• Two or more DDR4 DIMMs are considered “Like” DIMMs when all attributes minus the Vendor, and/or DIMM Part # and/or DIMM Revision#, are the same.</li> </ul>			
Attribute	“Identical” DDR4 DIMM Attributes	“Like” DDR4 DIMM Attributes	Possible DDR4 Attribute Values
Vendor	Match	Maybe Different	Memory Vendor Name
DIMM Part #	Match	Maybe Different	Memory Vendor Part #
DIMM Revision #	Match	Maybe Different	Memory Vendor Part Revision #
SDRAM Type	Match	Match	DDR4
DIMM Type	Match	Match	RDIMM, LRDIMM
Speed (MHz)	Match	Match	2666, 2933, 3200
Voltage	Match	Match	1.2V
DIMM Size (GB)	Match	Match	8GB, 16GB, 32GB, 64GB, 128GB, 256GB
Organization	Match	Match	1Gx72; 2Gx72; 4Gx72; 8Gx72; 16Gx72; 32Gx72
DIMM Rank	Match	Match	1R, 2R, 4R, 8R
DRAM Width	Match	Match	x4, x8
DRAM Density	Match	Match	8Gb, 16Gb

## 4.3 Thermal Management Overview

In order to maintain the necessary airflow within the system, all of the previously listed components and top cover need to be properly installed. For optimum system performance, the external ambient temperature should remain below 35 °C and all system fans should be operational. System fan redundancy can be supported for system configurations that meet the necessary fan redundancy support limits identified in Appendix D.

For system configurations that support fan redundancy, should a single fan failure occur (system fan or power supply fan), integrated platform management changes the state of the system status LED to blinking green, reports an error to the system event log, and automatically adjusts fan speeds as needed to maintain system temperatures below maximum thermal limits.

---

**Note:** All system fans are controlled independently of each other. The fan control system may adjust fan speeds for different fans based on increasing/decreasing temperatures in different thermal zones within the chassis.

---

In the event that system temperatures should continue to increase with the system fans operating at their maximum speed, platform management may begin to throttle bandwidth of either the memory subsystem, the processors, or both to keep components from overheating and keep the system operational. Throttling of these subsystems continues until system temperatures are reduced below preprogrammed limits.

The power supply is protected against over temperature conditions caused by excessive ambient temperature. In an over-temperature protection condition, the power supply module shuts down.

Should system thermals increase to a point beyond the maximum thermal limits, the system shuts down, the system status LED changes to solid amber, and the event is logged to the system event log. Should power supply thermals increase to a point beyond their maximum thermal limits or if a power supply fan should fail, the power supply shuts down.

---

**Note:** For proper system thermal management, Sensor Data Records (SDRs) for any given system configuration must be loaded by the system integrator as part of the initial system integration process. SDRs are loaded using the FRUSDR utility, which is part of the System Update Package (SUP) or One-boot Firmware Update (OFU) package, which can be downloaded from <http://downloadcenter.intel.com>.

---

### 4.3.1 Fan Speed Control

The BMC controls and monitors the system fans. Each fan is associated with a fan speed sensor that detects fan failure and may also be associated with a fan presence sensor for hot-swap support. For redundant fan configurations, the fan failure status and fan presence status determine the fan redundancy sensor state.

The system fans are divided into fan domains, each of which has a separate fan speed control signal and a separate configurable fan control policy. A fan domain can have a set of temperature and fan sensors associated with it. These are used to determine the current fan domain state.

A fan domain has three states: sleep, boost, and nominal. The sleep and boost states have fixed (but configurable through OEM SDRs) fan speeds associated with them. The nominal state has a variable speed determined by the fan domain policy. An OEM SDR record is used to configure the fan domain policy.

The fan domain state is controlled by several factors. The factors for the boost state are listed below in order of precedence, high to low. If any of these conditions apply, the fans are set to a fixed boost state speed.

- An associated fan is in a critical state or missing. The SDR describes which fan domains are boosted in response to a fan failure or removal in each domain. If a fan is removed when the system is in fans-off mode, it is not detected and there is not any fan boost until the system comes out of fans-off mode.
- Any associated temperature sensor is in a critical state. The SDR describes which temperature-threshold violations cause fan boost for each fan domain.
- The BMC is in firmware update mode, or the operational firmware is corrupted.

For more information on nominal fan speed, see Section 4.3.1.4.

#### **4.3.1.1 Programmable Fan PWM Offset**

The system provides a BIOS setup option to boost the system fan speed by a programmable positive offset setting. Setting the **Fan PWM Offset** option causes the BMC to add the offset to the fan speeds to which it would otherwise be driving the fans. This setting causes the BMC to replace the domain minimum speed with alternate domain minimums that are programmable also through SDRs.

This capability is offered to provide system administrators the option to manually configure fan speeds in instances where the fan speed optimized for a given platform may not be sufficient when a high end add-in adapter is configured into the system. This enables easier usage of the fan speed control to support Intel and non-Intel chassis and better support of ambient temperatures higher than 35 °C.

#### **4.3.1.2 Fan Redundancy Detection**

The BMC supports redundant fan monitoring and implements a fan redundancy sensor. A fan redundancy sensor generates events when its associated set of fans transitions between redundant and non-redundant states, as determined by the number and health of the fans. The definition of fan redundancy is configuration dependent. The BMC allows redundancy to be configured on a per fan redundancy sensor basis through OEM SDR records.

A fan failure or removal of hot-swap fans up to the number of redundant fans specified in the SDR in a fan configuration is a non-critical failure and is reflected in the front panel status. A fan failure or removal that exceeds the number of redundant fans is a non-fatal, insufficient-resources condition and is reflected in the front panel status as a non-fatal error.

Redundancy is checked only when the system is in the DC-on state. Fan redundancy changes that occur when the system is DC-off or when AC is removed will not be logged until the system is turned on.

#### **4.3.1.3 Fan Domains**

System fan speeds are controlled through pulse width modulation (PWM) signals, which are driven separately for each domain by integrated PWM hardware. Fan speed is changed by adjusting the duty cycle, which is the percentage of time the signal is driven high in each pulse.

The BMC controls the average duty cycle of each PWM signal through direct manipulation of the integrated PWM control registers.

The same device may drive multiple PWM signals.

#### **4.3.1.4 Nominal Fan Speed**

A fan domain's nominal fan speed can be configured as static (fixed value) or controlled by the state of one or more associated temperature sensors.

OEM SDR records are used to configure which temperature sensors are associated with which fan control domains and the algorithmic relationship between the temperature and fan speed. Multiple OEM SDRs can

reference or control the same fan control domain and multiple OEM SDRs can reference the same temperature sensors.

The PWM duty cycle value for a domain is computed as a percentage using one or more instances of a stepwise linear algorithm and a clamp algorithm. The transition from one computed nominal fan speed (PWM value) to another is ramped over time to minimize audible transitions. The ramp rate is configurable by means of the OEM SDR.

Multiple stepwise linear and clamp controls can be defined for each fan domain and used simultaneously. For each domain, the BMC uses the maximum of the domain's stepwise linear control contributions and the sum of the domain's clamp control contributions to compute the domain's PWM value, except that a stepwise linear instance can be configured to provide the domain maximum.

Hysteresis can be specified to minimize fan speed oscillation and to smooth fan speed transitions. If a Tcontrol SDR record does not contain a hysteresis definition (for example, an SDR adhering to a legacy format), the BMC assumes a hysteresis value of zero.

#### **4.3.1.5 Thermal and Acoustic Management**

This feature refers to enhanced fan management to keep the system optimally cooled while reducing the amount of noise generated by the system fans. Aggressive acoustics standards might require a trade-off between fan speed and system performance parameters that contribute to the cooling requirements, primarily memory bandwidth. The BIOS, BMC, and SDRs work together to provide control over how this trade-off is determined.

This capability requires the BMC to access temperature sensors on the individual memory DIMMs. Additionally, closed-loop thermal throttling is only supported with DIMMs with temperature sensors.

#### **4.3.1.6 Thermal Sensor Input to Fan Speed Control**

The BMC uses various IPMI sensors as input to the fan speed control. Some of the sensors are IPMI models of actual physical sensors whereas some are "virtual" sensors whose values are derived from physical sensors using calculations and/or tabular information.

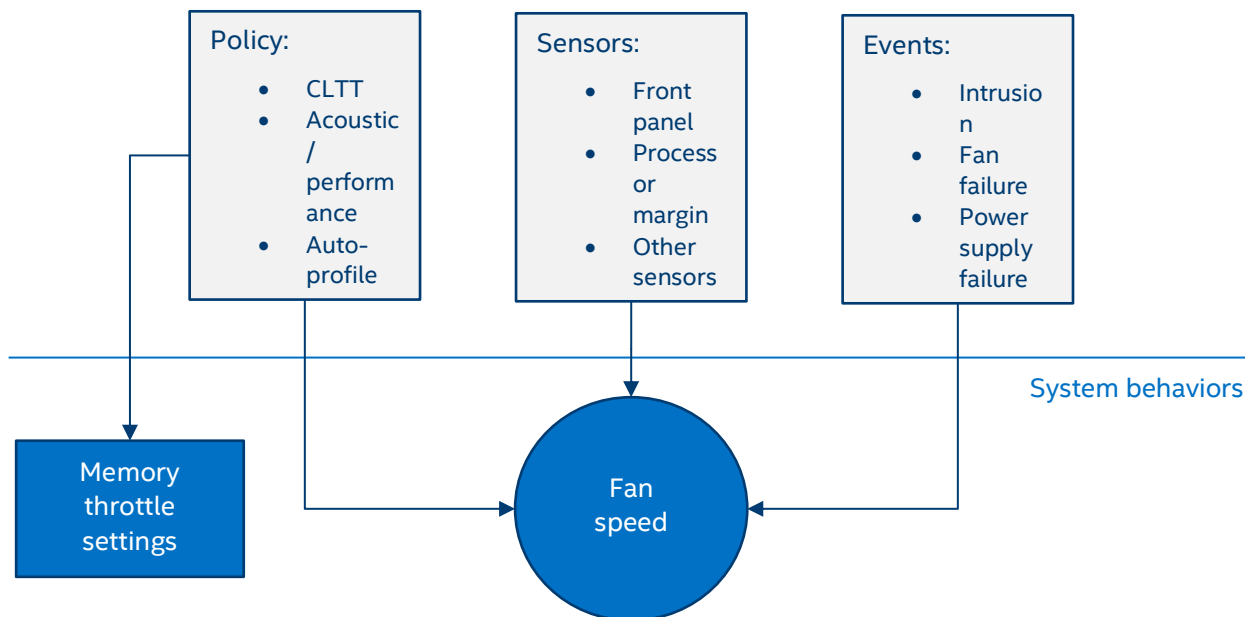
The following IPMI thermal sensors are used as input to fan speed control:

- Front panel temperature sensor <sup>1</sup>
- CPU margin sensors <sup>2, 4, 5</sup>
- DIMM thermal margin sensors <sup>2, 4</sup>
- Exit air temperature sensor <sup>1, 7, 9</sup>
- PCH temperature sensor <sup>3, 5</sup>
- Onboard Ethernet controller temperature sensors <sup>3, 5</sup>
- Add-in SAS module temperature sensors <sup>3, 5</sup>
- PSU thermal sensor <sup>3, 8</sup>
- CPU VR temperature sensors <sup>3, 6</sup>
- DIMM VR temperature sensors <sup>3, 6</sup>
- BMC temperature sensor <sup>3, 6</sup>
- Global aggregate thermal margin sensors <sup>7</sup>
- Hot swap backplane temperature sensors
- Intel® OCP module temperature sensor (with option installed)
- Intel® SAS module (with option installed)
- Riser card temperature sensors (2U systems only)
- Intel® Xeon Phi™ coprocessor (2U system only with option installed)

**Notes:**

- <sup>1</sup> For fan speed control in Intel chassis
- <sup>2</sup> Temperature margin to max junction temp
- <sup>3</sup> Absolute temperature
- <sup>4</sup> PECI value or margin value
- <sup>5</sup> On-die sensor
- <sup>6</sup> Onboard sensor
- <sup>7</sup> Virtual sensor
- <sup>8</sup> Available only when PSU has PMBus
- <sup>9</sup> Calculated estimate

Figure 26 shows a high-level representation of the fan speed control structure that determines fan speed.



**Figure 26. High-level fan speed control model**

## 4.4 System Fans

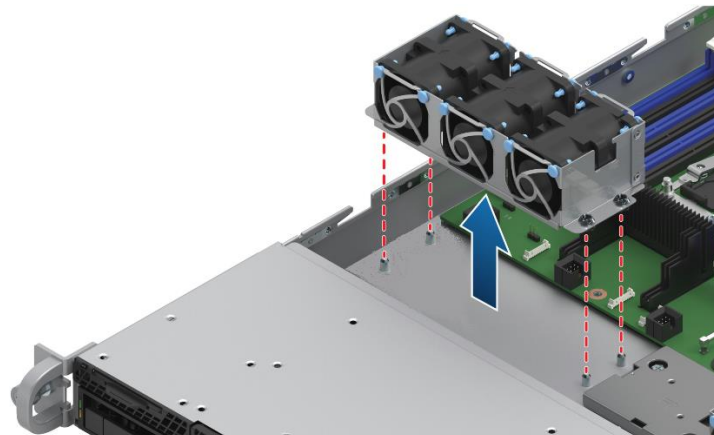
Six (6) dual-rotor, 40 x 56 mm system fans and an embedded fan for each installed power supply module provide the primary airflow for the system.

The system is designed for fan redundancy when configured with two power supply modules, all system fan rotors are operational, and ambient air remains at or below ASHRAE class 2 limits. Should a single system fan fail, platform management will adjust airflow of the remaining system fans and manage other platform features to maintain system thermals. Fan redundancy is lost if more than one system fan is in a failed state.

The system includes two system fan assemblies of three dual-rotor fans each. The fan assemblies are held in place by fitting them over mounting pins coming up from the chassis base. Each system fan includes support for the following:

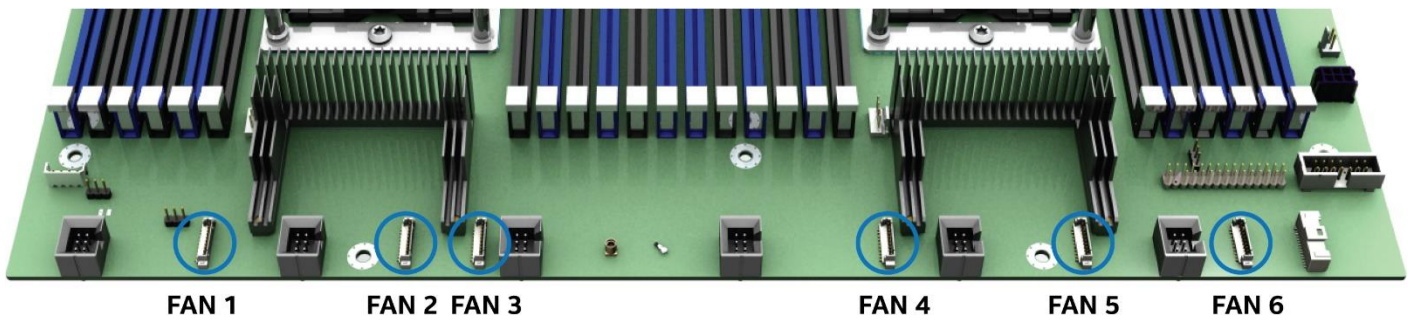
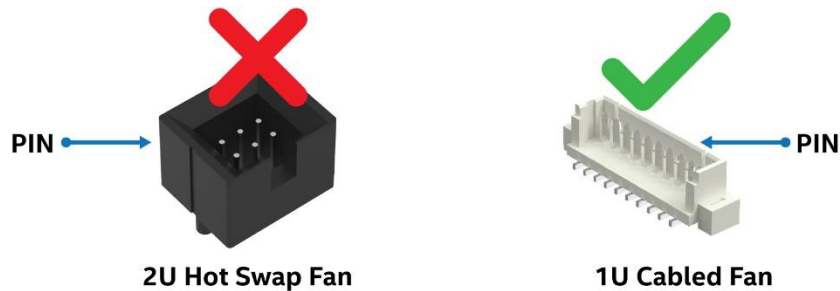
- System fans are not hot-swappable.
- Each fan is designed for tool-less insertion and extraction from the fan assembly.
- Each fan has a tachometer signal that allows the Integrated BMC to monitor its status.
- Fan speed for each fan is controlled by integrated platform management. As system thermals fluctuate high and low, the Integrated BMC firmware increases and decreases the speeds to specific fans within the fan assembly to regulate system thermals.

- Each fan includes an integrated fault LED located near the system fan connector. Platform management illuminates the fault LED for the failed fan.
- Each fan has a 10-pin wire harness that connects to a matching connector on the server board.



**Figure 27. System fan assembly**

On the server board, each system fan includes a pair of fan connectors, a 1x10 pin connector to support a dual rotor cabled fan typically used in 1U system configurations, and a 2x3 pin connector to support a single rotor hot swap fan assembly typically used in 2U system configurations. Concurrent use of both fan connector types for any given system fan pair is not supported.



**Figure 28. Server board 1U system fan connector locations**

WFP0040

**Table 36. System fan connector pinout**

SYS_FAN 1		SYS_FAN 2		SYS_FAN 3	
Signal Description	Pin#	Signal Description	Pin#	Signal Description	Pin#
FAN_TACH1	1	FAN_TACH3	1	FAN_TACH5	1
FAN_PWM0	2	FAN_PWM1	2	FAN_PWM2	2
P12V_CPU_DIMM	3	P12V_CPU_DIMM	3	P12V_CPU_DIMM	3
P12V_CPU_DIMM	4	P12V_CPU_DIMM	4	P12V_CPU_DIMM	4
FAN_TACH0	5	FAN_TACH2	5	FAN_TACH4	5
GROUND	6	GROUND	6	GROUND	6
GROUND	7	GROUND	7	GROUND	7
FM_SYS_FAN0_PRSENT_N	8	FM_SYS_FAN1_PRSENT_N	8	FM_SYS_FAN2_PRSENT_N	8
LED_FAN_FAULT0_R	9	LED_FAN_FAULT1_R	9	LED_FAN_FAULT2_R	9
LED_FAN0	10	LED_FAN1	10	LED_FAN2	10
SYS_FAN 4		SYS_FAN 5		SYS_FAN 6	
Signal Description	Pin#	Signal Description	Pin#	Signal Description	Pin#
FAN_TACH7	1	FAN_TACH9	1	FAN_TACH11	1
FAN_PWM3	2	FAN_PWM4	2	FAN_PWM5	2
P12V_CPU_DIMM	3	P12V_CPU_DIMM	3	P12V_CPU_DIMM	3
P12V_CPU_DIMM	4	P12V_CPU_DIMM	4	P12V_CPU_DIMM	4
FAN_TACH6	5	FAN_TACH8	5	FAN_TACH10	5
GROUND	6	GROUND	6	GROUND	6
GROUND	7	GROUND	7	GROUND	7
FM_SYS_FAN3_PRSENT_N	8	FM_SYS_FAN4_PRSENT_N	8	FM_SYS_FAN5_PRSENT_N	8
LED_FAN_FAULT3_R	9	LED_FAN_FAULT4_R	9	LED_FAN_FAULT5_R	9
LED_FAN3	10	LED_FAN4	10	LED_FAN5	10

## 4.5 Power Supply Module Fans

Each installed power supply module includes embedded (non-removable) 40-mm fans. They are responsible for airflow through the power supply module. These fans are managed by the fan control system. Should a fan fail, the power supply shuts down.

## 4.6 FRUSDR Utility

The purpose of the embedded platform management and fan control systems is to monitor and control various system features, and to maintain an efficient operating environment. Platform management is also used to communicate system health to supported platform management software and support mechanisms. The FRUSDR utility is used to program the server board with platform specific environmental limits, configuration data, and the appropriate sensor data records (SDRs) for use by these management features.

The FRUSDR utility must be run as part of the initial platform integration process before it is deployed into a live operating environment. Once the initial FRU and SDR data is loaded on to the system, all subsequent system configuration changes automatically update SDR data using the BMC auto configuration feature, without having to run the FRUSDR utility again. However, to ensure the latest sensor data is installed, the SDR data should be updated to the latest available as part of a planned system software update.

The FRUSDR utility for the given server platform can be downloaded as part of the system update package (SUP) or one-boot firmware update (OFU) package from <http://downloadcenter.intel.com>.

**Note:** The embedded platform management system may not operate as expected if the platform is not updated with accurate system configuration data. The FRUSDR utility must be run with the system fully configured during the initial system integration process for accurate system monitoring and event reporting.

The FRU and SDR files included in the SUP or OFU utility describe the sensors in the board, chassis and peripherals as shown in Figure 14 and Table 4.

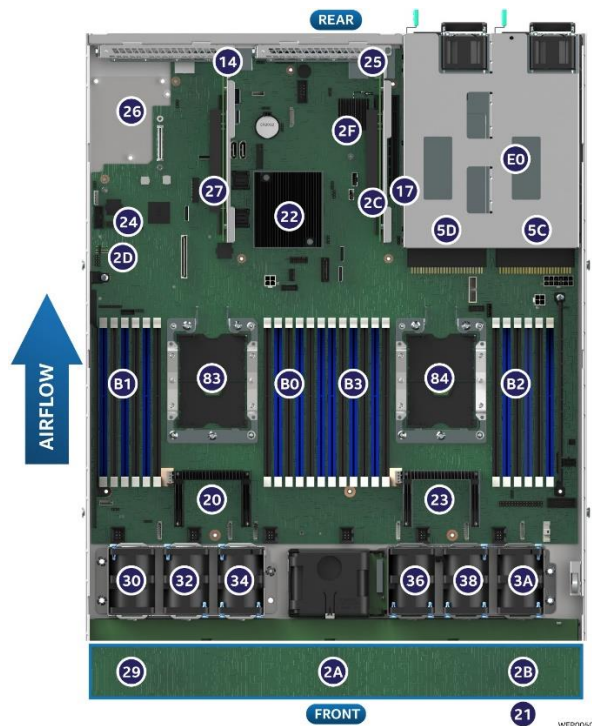


Figure 29. Intel® Server S2600WF Product Family Sensor Position

Table 37. Intel® Server S2600WF Product Family Sensor List

Sensor Number	Sensor Name	Sensor Number	Sensor Name
30h	System Fan 1	17h	Riser 3 Temp
32h	System Fan 2	91h	NVMe 1 Therm Mgn
34h	System Fan 3	92h	NVMe 2 Therm Mgn
36h	System Fan 4	93h	NVMe 3 Therm Mgn
38h	System Fan 5	2Dh	SAS Mod Temp
3Ah	System Fan 6	2Fh	LAN NIC Temp
83h	P1 DTS Therm Mgn	5Ah	IFT Mezz Temp
84h	P2 DTS Therm Mgn	5Bh	IFT PCIe Temp
B0h	DIMM Thrm Mrgn 1	5Eh	PCIe Aggr Margin
B1h	DIMM Thrm Mrgn 2	2Eh	Exit Air Temp
B2h	DIMM Thrm Mrgn 3	11h	System Airflow
B3h	DIMM Thrm Mrgn 4	A8h	PHI 1 Margin
C8h	Agg Therm Mgn 1	AAh	PHI 1 Avg Pwr
C9h	Agg Therm Mgn 2	A9h	PHI 2 Margin
20h	BB P1 VR Temp	Abh	PHI 2 Avg Pwr
23h	BB P2 VR Temp	C4h	UDHS 1 Margin



<b>Sensor Number</b>	<b>Sensor Name</b>	<b>Sensor Number</b>	<b>Sensor Name</b>
<b>24h</b>	BB BMC Temp	<b>C5h</b>	UDHS 2 Margin
<b>25h</b>	BB Rt Rear Temp	<b>C6h</b>	UDHS 3 Margin
<b>14h</b>	BB Lft Rear Temp	<b>C7h</b>	UDHS 4 Margin
<b>21h</b>	Front Panel Temp	<b>78h</b>	P1 Therm Ctrl %
<b>29h</b>	HSBP 1 Temp	<b>79h</b>	P2 Therm Ctrl %
<b>2Ah</b>	HSBP 2 Temp	<b>54h</b>	PS1 Input Power
<b>2Bh</b>	HSBP 3 Temp	<b>58h</b>	PS1 Curr Out %
<b>E0h</b>	HSBP 4 Temp	<b>5Ch</b>	PS1 Temperature
<b>22h</b>	SSB Temp	<b>55h</b>	PS2 Input Power
<b>26h</b>	OCP Mod Temp	<b>59h</b>	PS2 Curr Out %
<b>27h</b>	Riser 1 Temp	<b>5Dh</b>	PS2 Temperature
<b>2Ch</b>	Riser 2 Temp		

## 5. System Storage and Peripheral Drive Bay Overview

The Intel® Server System R2000WF product family has support for a variety of different storage options:

- Up to (8) hot swap 2.5" SAS/SATA/NVMe\* drives
- Up to (4) hot swap 3.5" SAS/SATA drives or 2.5" SSDs

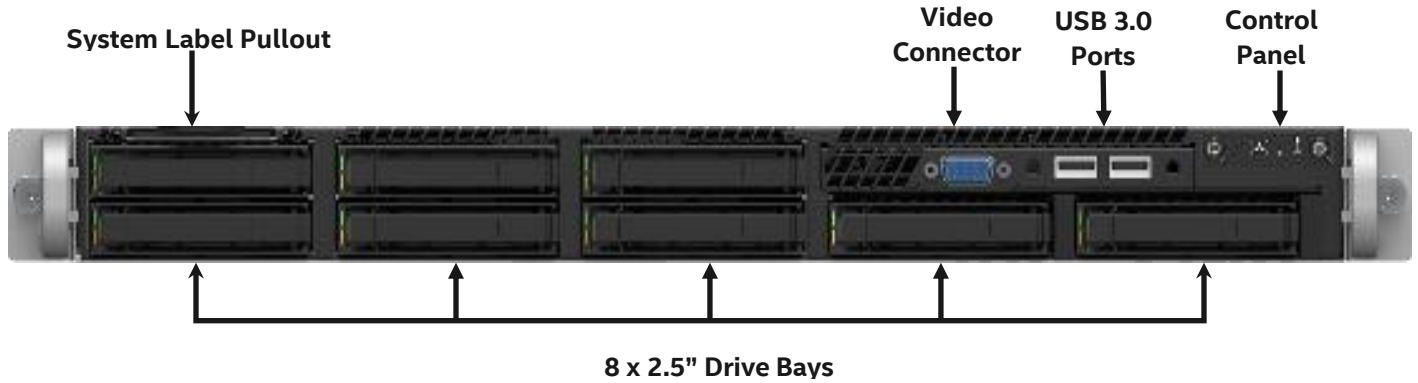


Figure 30. 2.5" drive bay, 8-drive configuration (R1208WFXXX)

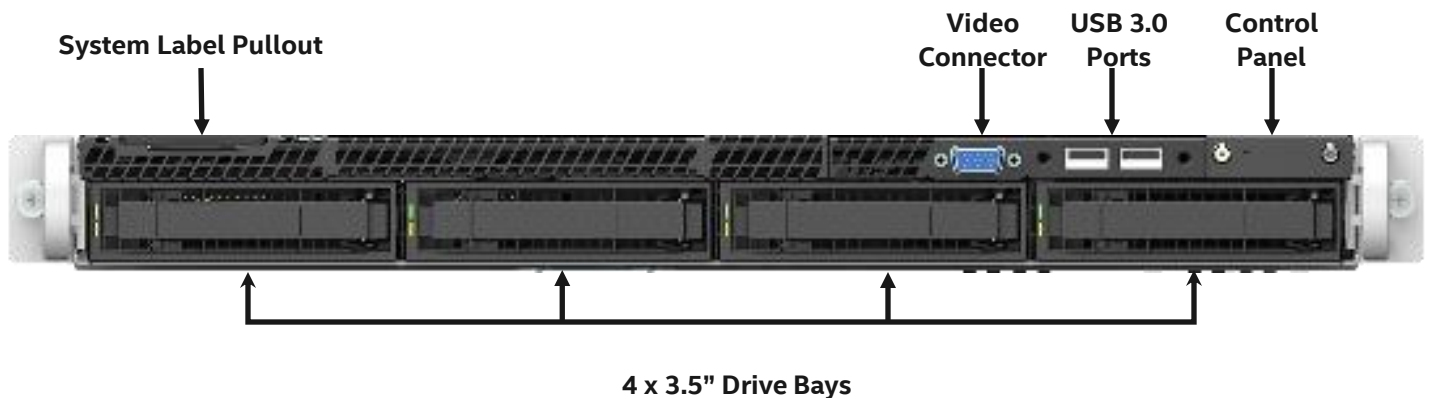


Figure 31. 3.5" drive bay, 4-drive configuration (R1304WFXXX)

## 5.1 Hot Swap Drive Carriers

Each SAS/SATA/NVMe\* drive that interfaces with a backplane is mounted to a tool-less hot swap drive carrier.

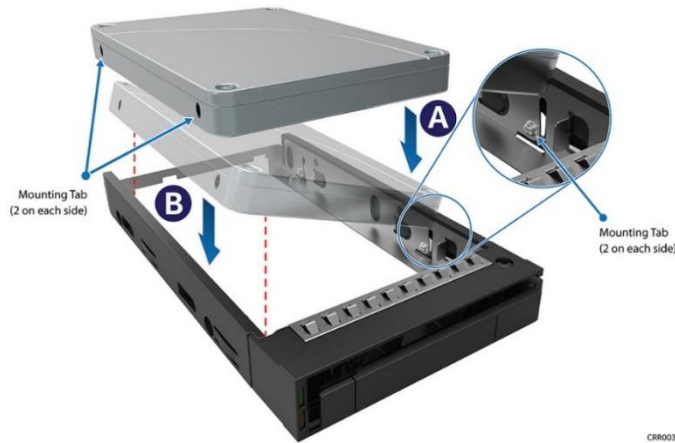


Figure 32. Hot swap drive carrier

Drive carriers include a latching mechanism used to assist with drive extraction and drive insertion.

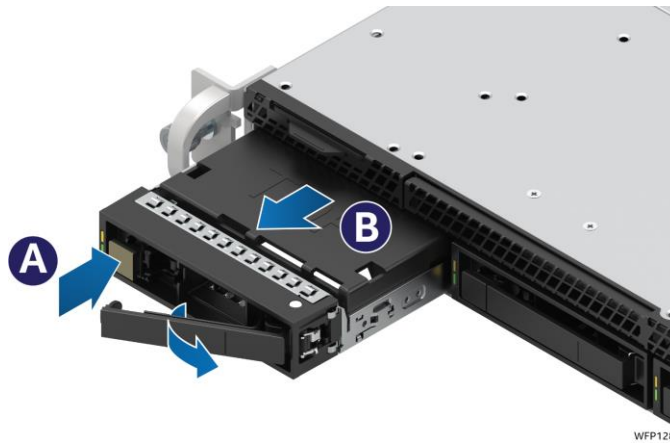


Figure 33. Drive carrier removal

---

**Note:** To ensure proper system airflow requirements, all front drive bays must be populated with a drive carrier. Drive carriers must be installed with either a drive or supplied drive blank.

---

There are drive carriers to support 2.5" drives and 3.5" drives. Drive blanks used with the 3.5" drive carrier can also be used to mount a 2.5" SSD.

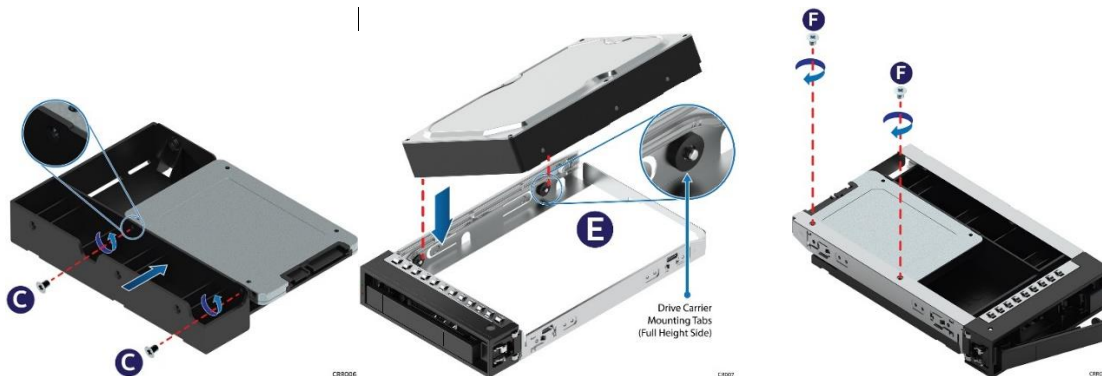


Figure 34. 2.5" SSD mounted to 3.5" drive carrier

**Note:** Due to degraded performance and reliability concerns, the use of the 3.5” drive blank as a 2.5” drive bracket is intended to support SSD type storage devices only. Installing a 2.5” hard disk drive into the 3.5” drive blank cannot be supported.

Each drive carrier includes separate LED indicators for drive activity and drive status. Light pipes integrated into the drive carrier assembly direct light emitted from LEDs mounted next to each drive connector on the backplane to the drive carrier faceplate, making them visible from the front of the system.



**Figure 35. Drive tray LED identification**

**Table 38. Drive status LED states**

	LED State	Drive Status
<b>Amber</b>	Off	No access and no fault
	Solid on	Hard drive fault has occurred
	1 Hz blinking	RAID rebuild in progress
	2 Hz blinking	Locate (identify)

**Table 39. Drive activity LED states**

	Condition	Drive Type	LED Behavior
<b>Green</b>	Power on with no drive activity	SAS/NVMe*	LED stays on
		SATA	LED stays off
	Power on with drive activity	SAS/NVMe*	LED blinks off when processing a command
		SATA	LED blinks on when processing a command
	Power on and drive spun down	SAS/NVMe*	LED stays off
		SATA	LED stays off
Power on and drive spinning up	SAS/NVMe*	LED blinks	
	SATA	LED stays off	

**Table 40. PCIe\* SSD drive status LED states**

	LED State	Drive Status
<b>Amber</b>	Off	No fault, OK
	4 Hz blinking	Locate (identify)
	Solid on	Fault/fail
	1 Hz blinking	Rebuild

**Note:** The drive activity LED is driven by signals coming from the drive itself. Drive vendors may choose to operate the activity LED different from what is described in the table above. Should the activity LED on a given drive type behave differently than what is described, customers should reference the drive vendor specifications for the specific drive model to determine the expected drive activity LED operation.

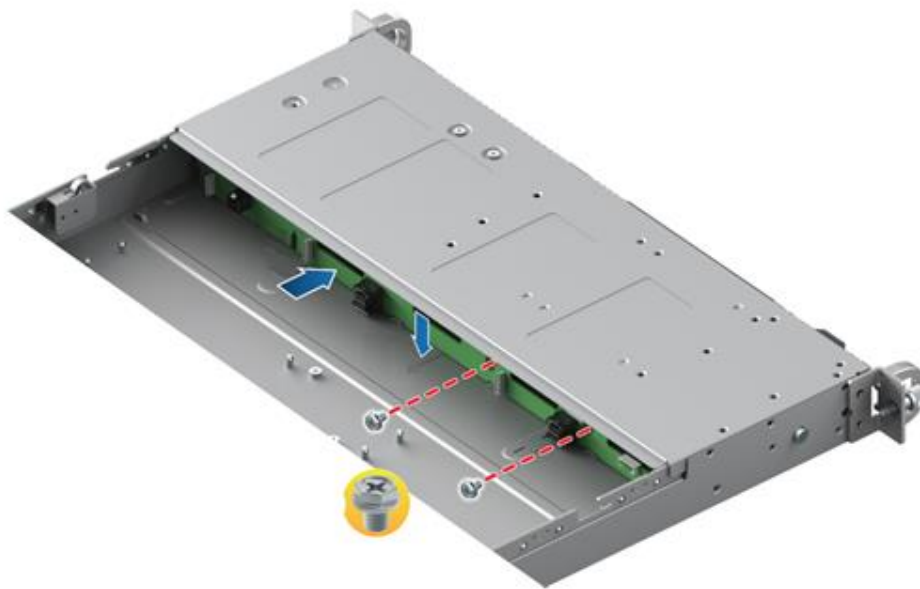
## 5.2 Hot Swap Backplane Support

The 1U system has support for two backplane options.

For 2.5" drives, available backplane options include:

- 8 x 2.5" drive combo backplane with support for SAS/SATA/NVMe
- 4 x 3.5" drive backplane with support for SAS/SATA

All available backplane options mount directly to the back of the drive bay as shown in Figure 36.



**Figure 36. Backplane installation**

Backplanes include the following features:

- 12 Gb SAS and 6 Gb SAS/SATA or slower support
- Drive interface connectors
  - 29-pin SFF-8680 – SATA/SAS only
  - 68-pin SFF-8639 – SATA/SAS/NVMe\* – NVMe\* compatible backplanes only
- Hot swap drive support
- Cable connectors
  - SFF-8643 Mini-SAS HD – 2.5" and 3.5" backplanes – 12 Gb SAS capable
  - OCuLink\* PCIe\* interface – NVMe\* compatible backplanes only
  - 1x5-pin connector – I2C interface for device status communication to the BMC over secondary SMBus\*
  - 2x2-pin connector – power
- SGPIO SFF-8485 interface embedded within the sideband of the mini-SAS HD connectors
- HSBP microcontroller – Cypress\* CY8C22545-24AXI PSoC\* Programmable System-on-Chip device
- LEDs to indicate drive activity and status for each attached device
- Device presence detect inputs to the microcontroller

- 5 V VR for devices
- 3.3 V VR for microcontroller
- In-application microcontroller firmware updateable over the I2C interface
- FRU EEPROM support
- Temperature sensor through the use of a TMP75 (or equivalent) thermistor implementation with the microcontroller

### 5.2.1 SGPIO Functionality

Backplanes include support for an SFF-8485 compliant SGPIO interface used to activate the status LED. This interface is also monitored by the microcontroller for generating FAULT, IDENTIFY, and REBUILD registers that in turn are monitored by the server board BMC for generating corresponding SEL events.

### 5.2.2 I<sup>2</sup>C Functionality

The microcontroller has a primary/secondary I<sup>2</sup>C connection to the server board BMC. The microcontroller is not an IPMB compliant device. The BMC generates SEL events by monitoring registers on the HSBP microcontroller for DRIVE PRESENCE, FAULT, and RAID REBUILD in progress.

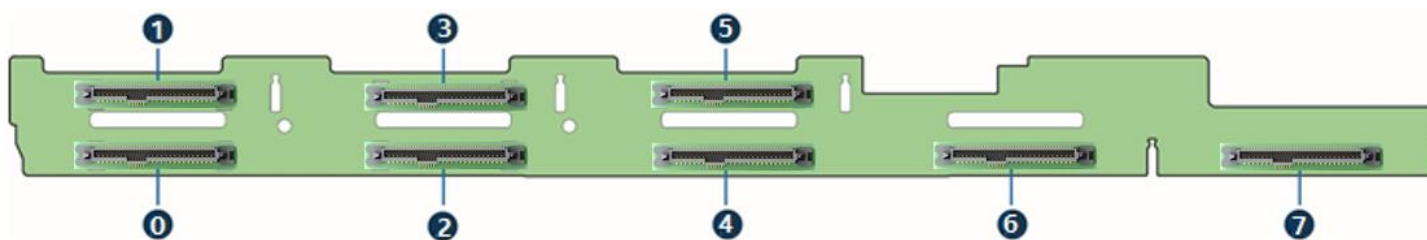
## 5.3 8 x 2.5" Drive SATA/SAS/NVMe\* Combo Backplane

This section applies to the 8 x 2.5" drive SAS/SATA/NVMe\* combo backplane (iPC – F1U8X253PHS).

All system SKUs capable of supporting 2.5" drives include an eight drive backplane capable of supporting 12 Gb/sec SAS, 6 Gb/sec SATA drives, and PCIe\* NVMe\* drives.

The 8x2.5" drive combo backplane has support for different drive configurations including SAS or SATA only, NVMe\* only, or a combination of both SAS and NVMe. Mixing of SATA and SAS devices within a common hot swap backplane is not supported. Hard disk drives (HDDs) and solid state drives (SSDs) can be supported within a common backplane.

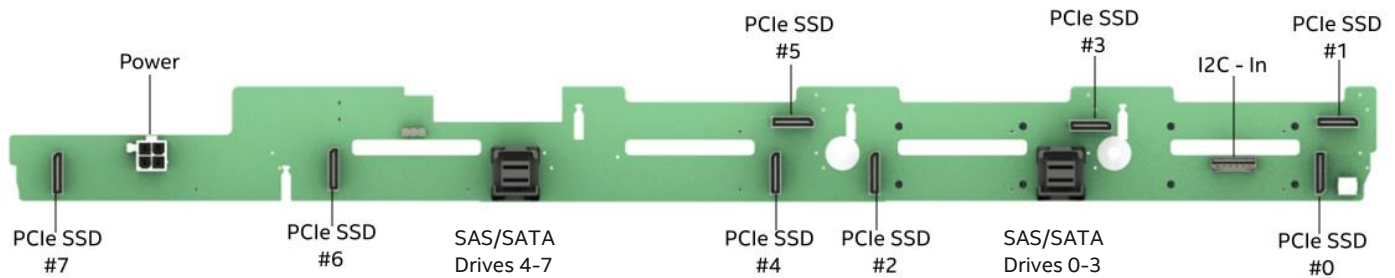
The front side of the backplane includes eight 68-pin SFF-8639 drive interface connectors, each capable of supporting SAS, SATA, or NVMe\* drives. The connectors are numbered 0 through 7.



**Figure 37. 8 x 2.5" SAS/SATA/NVMe\* hot swap backplane, front side**

The backplane and backplane management features can support drives installed in any order when populating mixed SATA/NVMe\* or SAS/NVMe\* drive configurations. However, when mixing NVMe\* and SATA/SAS within a common backplane, Intel recommends drive types be populated together and not in an intermixed order. In addition, drive population rules must be followed and drive support limitations exist when the optional Intel® VROC upgrade key is installed to the server board providing support for NVMe\* RAID and NVMe\* management features (see Section 6.4.4).

The backside of the backplane includes two multiport mini-SAS HD connectors labeled SAS/SATA\_0-3 and SAS/SATA\_4-7, and eight PCIe OCuLink\* connectors, each labeled PCIe SSD#, where # = 0 -7, one connector for each installed NVMe\* drive.



**Figure 38. 8 x 2.5" SAS/SATA/NVMe\* hot swap backplane, back side**

- **I<sup>2</sup>C cable connectors** – The backplane includes a 1x5 cable connector used as a management interface to the server board.

**Table 41. I<sup>2</sup>C cable connector pinout**

Pin	Signal
1	SMB_3V3SB_DAT
2	GND
3	SMB_3V3SB_CLK
4	SMB_ADD0
5	SMB_ADD1

- **Multiport mini-SAS HD cable connectors** – The backplane includes two, multiport mini-SAS HD (SFF-8643) cable connectors, each providing I/O signals for four SAS/SATA hard drives on the backplane. Cables can be routed from matching connectors on the server board for SATA only support, or from an add-in SAS/SATA RAID card.
- **Power harness connector**– The backplane includes a 2x2 connector supplying power to the backplane. Power is routed to each installed backplane via a multi-connector power cable harness from the server board.

**Table 42. Power harness connector pinout**

Pin	Signal
1	GND
2	GND
3	P12V
4	P12V

- **PCIe OCuLink\* connectors** – The backplane has support for up to eight NVMe\* SFF SSDs. The backside of the backplane includes eight OCuLink\* cable connectors, one for each drive connector on the front side of the backplane. Each installed NVMe\* drive must have PCIe signals cabled to the appropriate backplane OCuLink\* connector from any of the following PCIe signal sources:
  - Available onboard PCIe OCuLink\* connectors on the server board.
  - Optional PCIe 4- or 8-port switch add-in card.
  - Optional PCIe 4 port Retimer Add-in Card

See Section 6.4 for NVMe\* support information.

## 5.4 4 x 3.5" Drive Hot-Swap Backplane

This section applies to the 4 x 3.5" drive hot-swap backplane (iPC – FR1304S3HSBP).

All 3.5" drive system SKUs within the product family ship with a 4 x drive backplane capable of supporting 12 Gb/sec SAS and 6 Gb/sec SAS / SATA drives. Both HDDs and SSDs can be supported within a common backplane. Each backplane can support either SATA or SAS devices. However, mixing of SATA and SAS devices within a common hot swap backplane is not supported. Supported devices are dependent on the type of host bus controller driving the backplane: SATA only or SAS.

The front side of the backplane includes four 29-pin SFF-8680 drive interface connectors, each capable of supporting 12 Gb SAS or 6 Gb SAS/SATA. The connectors are numbered 0–3. Signals for all four drive connectors are routed to a single multiport, mini-SAS HD SFF-8643 connector on the back side of the backplane.

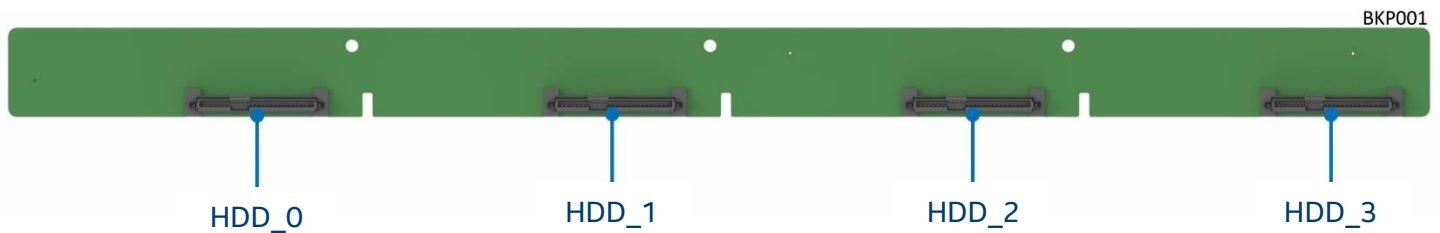


Figure 39. 4 x 3.5" hot swap backplane, front side

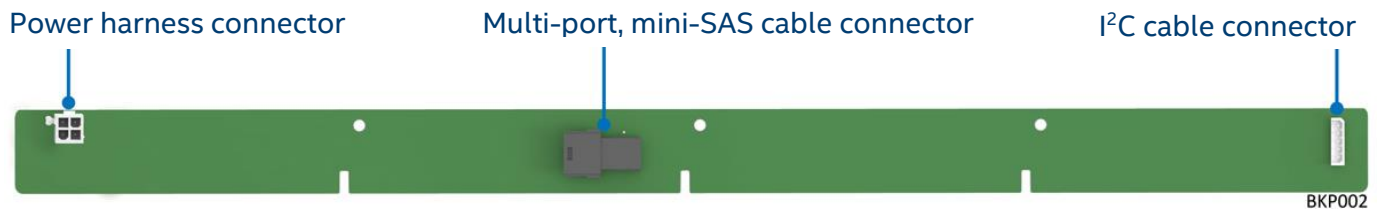


Figure 40. 4 x 3.5" hot swap backplane, front side

- **Power harness connector** – The backplane includes a 2x2 connector supplying power to the backplane. Power is routed to the backplane via a power cable harness from the server board
- **Multiport mini-SAS cable connector** – The backplane includes one multiport mini-SAS cable connector providing I/O signals for four SAS/SATA drives on the backplane. A cable can be routed from matching connectors on the server board or add-in SAS/SATA RAID cards.
- **I²C cable connector** – The backplane includes a 1x5 cable connector used as a management interface to the server board.



## 6. Storage Controller Options Overview

The Intel® Server System R1000WF product family has support for a variety of storage controller and storage device options including:

- Onboard SATA support
- Embedded software RAID support
- M.2 SSD support
- NVMe\* SFF SSD support
- Intel® Integrated RAID Modules support

### 6.1 Onboard SATA Support

The server board uses two chipsets embedded AHCI SATA controllers, identified as SATA and sSATA, providing for up to twelve 6 Gb/sec SATA ports.

The AHCI sSATA controller supports up to four SATA ports on the server board:

- Two ports accessed via two white single port 7-pin connectors labeled “sSATA-4” and “sSATA-5” on the server board.
- Two ports (sSATA 1 and sSATA 2) via two M.2 SSD connectors.

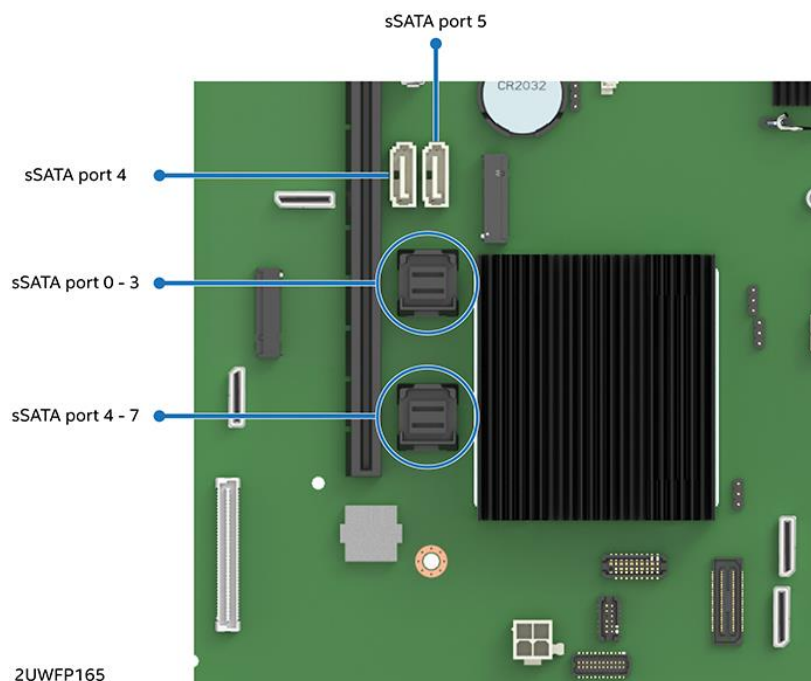
The AHCI SATA controller supports up to eight SATA ports on the server board (Intel Server Boards S2600WFTR and S2600WOR only):

- Four ports from the mini-SAS HD (SFF-8643) connector labeled “SATA Ports 0–3” on the server board.
- Four ports from the mini-SAS HD (SFF-8643) connector labeled “SATA Ports 4–7” on the server board.

---

**Note:** The onboard SATA controllers are not compatible with and cannot be used with SAS expander cards.

---



**Figure 41. Onboard SATA port connector identification**

**Table 43. SATA and sSATA controller feature support**

Feature	Description	AHCI Mode	RAID Mode Intel® VROC (SATA RAID)	RAID Mode Intel® ESRT2
Native Command Queuing (NCQ)	Allows the device to reorder commands for more efficient data transfers	Supported	Supported	
Auto Activate for DMA	Collapses a DMA Setup then DMA Activate sequence into a DMA Setup only	Supported	Supported	
Hot Plug Support	Allows for device detection without power being applied and ability to connect and disconnect devices without prior notification to the system	Supported	Supported	
Asynchronous Signal Recovery	Provides a recovery from a loss of signal or establishing communication after hot plug	Supported	Supported	
6 Gb/s Transfer Rate	Capable of data transfers up to 6 Gb/s	Supported	Supported	Supported
ATAPI Asynchronous Notification	A mechanism for a device to send a notification to the host that the device requires attention	Supported	Supported	
Host & Link Initiated Power Management	Capability for the host controller or device to request Partial and Slumber interface power states	Supported	Supported	
Staggered Spin-Up	Enables the host the ability to spin up hard drives sequentially to prevent power load problems on boot	Supported	Supported	Supported
Command Completion Coalescing	Reduces interrupt and completion overhead by allowing a specified number of commands to complete and then generating an interrupt to process the commands	Supported	N/A	

The SATA controller and the sSATA controller can be independently enabled and disabled and configured through the BIOS setup utility under the Mass Storage Controller Configuration menu screen. The following table identifies supported setup options.

**Table 44. SATA and sSATA controller BIOS setup utility options**

SATA Controller	sSATA Controller	Supported
AHCI	AHCI	Yes
AHCI	Disabled	Yes
AHCI	Intel® VROC (SATA RAID) 6.0	Yes
AHCI	Intel® ESRT2	Microsoft Windows* only
Disabled	AHCI	Yes
Disabled	Disabled	Yes
Disabled	Intel® VROC (SATA RAID) 6.0	Yes
Disabled	Intel® ESRT2	Yes
Intel® VROC (SATA RAID) 6.0	AHCI	Yes
Intel® VROC (SATA RAID) 6.0	Disabled	Yes
Intel® VROC (SATA RAID) 6.0	Intel® VROC (SATA RAID) 6.0	Yes
Intel® VROC (SATA RAID) 6.0	Intel® ESRT2	No
Intel® ESRT2	AHCI	Microsoft Windows only
Intel® ESRT2	Disabled	Yes
Intel® ESRT2	Intel® VROC (SATA RAID) 6.0	No
Intel® ESRT2	Intel® ESRT2	Yes

### 6.1.1 Staggered Disk Spin-Up

Because of the high density of disk drives that can be attached to the Intel® C620 onboard AHCI SATA controller and the sSATA controller, the combined startup power demand surge for all drives at once can be much higher than the normal running power requirements and could require a much larger power supply for startup than for normal operations.

In order to mitigate this and lessen the peak power demand during system startup, both the AHCI SATA Controller and the sSATA Controller implement a Staggered Spin-Up capability for the attached drives. This means that the drives are started separately, with a certain delay between disk drives starting.

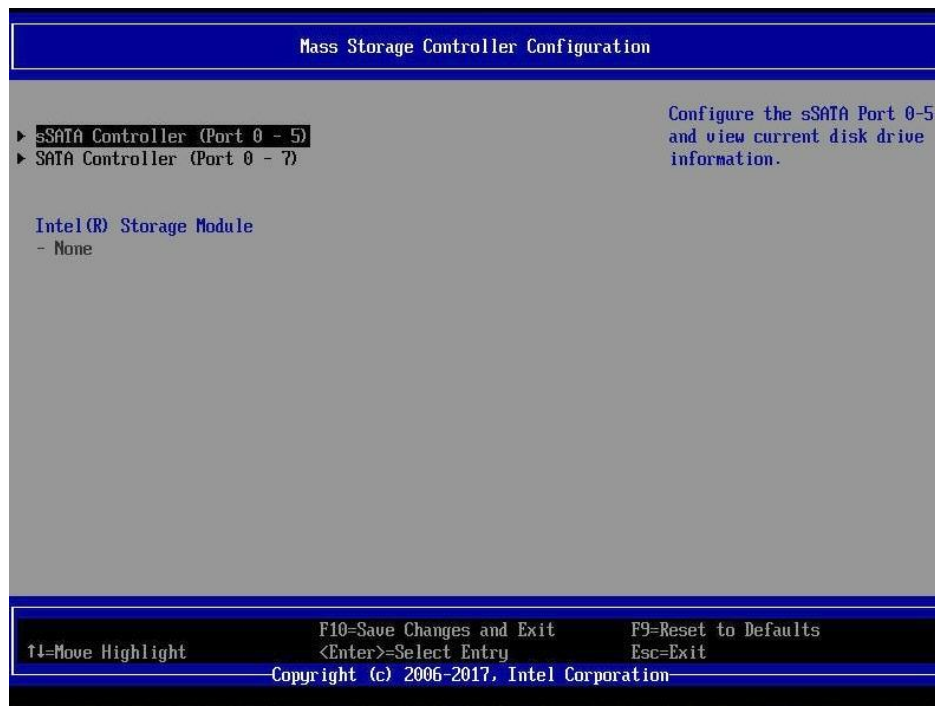
For the onboard SATA controller, staggered spin-up is an option – **AHCI HDD Staggered Spin-Up** – in the Mass Storage Controller Configuration screen found in the BIOS setup utility.

## 6.2 Onboard SATA Software RAID Support

The server board includes support for two embedded SATA RAID options:

- Intel® VROC (SATA RAID) 6.0
- Intel® Embedded Server RAID Technology 2 (Intel® ESRT2) 1.60

By default, onboard RAID options are disabled in BIOS setup. To enable onboard RAID support, access the BIOS setup utility during POST. The onboard RAID options can be found under the **sSATA Controller** or **SATA Controller** options under the following BIOS setup menu: **Advanced > Mass Storage Controller Configuration**.



**Figure 42. BIOS setup Mass Storage Controller Configuration screen**

---

**Note:** RAID partitions created using either Intel® VROC (SATA RAID) 6.0 or Intel ESRT2 cannot span across the two embedded SATA controllers. Only drives attached to a common SATA controller can be included in a RAID partition.

---

### 6.2.1 Intel® VROC (SATA RAID) 6.0

Intel® VROC (SATA RAID) 6.0 offers several options for RAID to meet the needs of the end user. AHCI support provides higher performance and alleviates disk bottlenecks by taking advantage of the independent DMA engines that each SATA port offers in the chipset. Supported RAID levels include 0, 1, 5, and 10.

- **RAID 0** – Uses striping to provide high data throughput, especially for large files in an environment that does not require fault tolerance.
- **RAID 1** – Uses mirroring so that data written to one disk drive simultaneously writes to another disk drive. This is good for small databases or other applications that require small capacity but complete data redundancy.
- **RAID 5** – Uses disk striping and parity data across all drives (distributed parity) to provide high data throughput, especially for small random access.
- **RAID 10** – A combination of RAID 0 and RAID 1, consists of striped data across mirrored spans. It provides high data throughput and complete data redundancy but uses a larger number of spans.

By using Intel® VROC (SATA RAID), there is no loss of PCI resources (request/grant pair) or add-in card slot. Intel® VROC (SATA RAID) functionality requires the following:

- The embedded RAID option must be enabled in BIOS setup.
- Intel® VROC (SATA RAID) option must be selected in BIOS setup.
- Intel® VROC (SATA RAID) drivers must be loaded for the installed operating system.
- At least two SATA drives needed to support RAID levels 0 or 1.
- At least three SATA drives needed to support RAID level 5.
- At least four SATA drives needed to support RAID level 10.
- NVMe\* SSDs and SATA drives must not be mixed within a single RAID volume.

With Intel® VROC (SATA RAID) 6.0 software RAID enabled, the following features are made available:

- A boot-time, pre-operating-system environment, text-mode user interface that allows the user to manage the RAID configuration on the system. Its feature set is kept simple to keep size to a minimum but allows the user to create and delete RAID volumes and select recovery options when problems occur. The user interface can be accessed by pressing <CTRL-I> during system POST.
- Boot support when using a RAID volume as a boot disk. It does this by providing Int13 services when a RAID volume needs to be accessed by MS-DOS applications (such as NT loader (NTLDR)) and by exporting the RAID volumes to the system BIOS for selection in the boot order.
- At each boot, a status of the RAID volumes provided to the user.

### 6.2.2 Intel® Embedded Server RAID Technology 2 (Intel® ESRT2) 1.60 for SATA

Intel ESRT2 (powered by LSI\*) is a driver-based RAID solution for SATA that is compatible with previous generation Intel® server RAID solutions. Intel ESRT2 provides RAID levels 0, 1, and 10, with an optional RAID 5 capability depending on whether a RAID upgrade key is installed.

---

**Note:** The embedded Intel ESRT2 option has no RAID support for PCIe\* NVMe\* SSDs.

---

Intel ESRT2 is based on LSI MegaRAID software stack and uses the system memory and CPU.

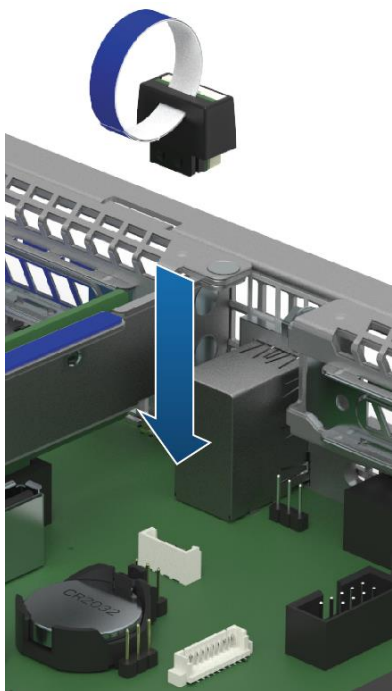
Supported RAID levels include:

- **RAID 0** – Uses striping to provide high data throughput, especially for large files in an environment that does not require fault tolerance.
- **RAID 1** – Uses mirroring so that data written to one disk drive simultaneously writes to another disk drive. This is good for small databases or other applications that require small capacity but complete data redundancy

- **RAID 10** – A combination of RAID 0 and RAID 1, consists of striped data across mirrored spans. It provides high data throughput and complete data redundancy but uses a larger number of spans.

Optional support for RAID level 5 can be enabled with the addition of a RAID 5 upgrade key (iPN – RKSATA4R5).

- **RAID 5** – Uses disk striping and parity data across all drives (distributed parity) to provide high data throughput, especially for small random access.



**Figure 43. Intel® ESRT2 SATA RAID-5 upgrade key**

---

**Note:** The onboard connector used to provide support for the Intel® ESRT2 SATA RAID-5 upgrade key is also used to support the Intel® VROC (VMD NVMe\* RAID) upgrade key options.

---

Intel ESRT2 on this server board supports a maximum of six drives, which is the maximum onboard SATA port support.

The binary driver includes partial source files. The driver is fully open source using an MDRAID layer in Linux\*.

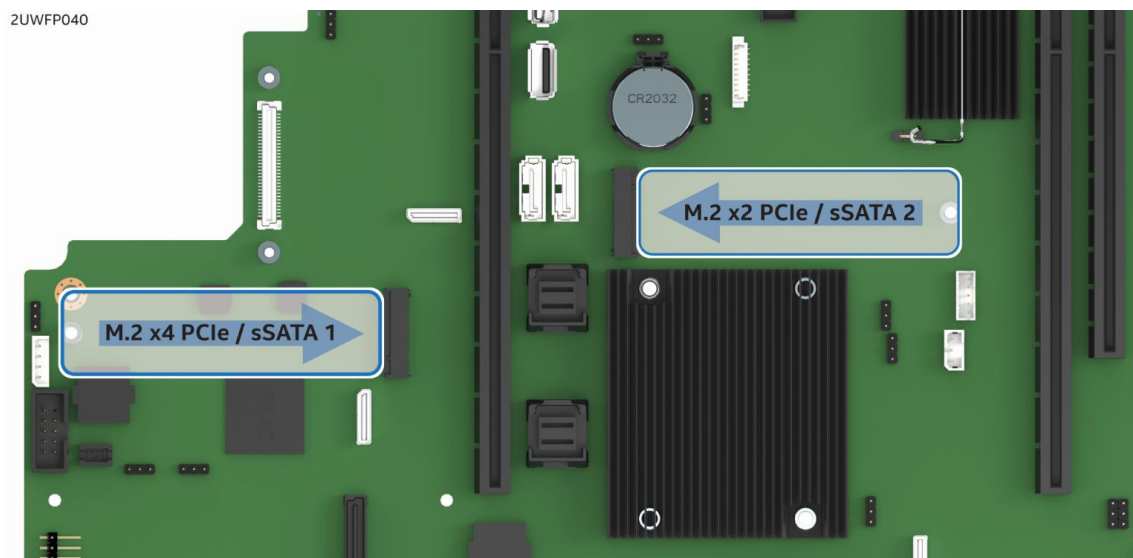
---

**Note:** RAID configurations cannot span across the two embedded AHCI SATA controllers.

---

## 6.3 M.2 SSD Support

The Intel Server Board S2600WF product family includes two M.2 SSD connectors labeled “M2\_x4PCIE/sSATA\_1” and “M2\_x2PCIE/sSATA\_2” on the server board as shown in Figure 44.



**Figure 44. M.2 module connector locations**

Each M.2 connector can support PCIe or SATA modules that conform to a 2280 (80 mm) form factor.

PCIe bus lanes for each connector are routed from the Intel chipset and can be supported in single processor configurations.

The M.2 connector to the left of Riser Slot #1 is supported by PCIe x4 bus lanes and sSATA-1 from the chipset embedded sSATA controller. The M.2 connector to the right of Riser Slot #1 is supported by PCIe x2 bus lanes and sSATA-2 from the chipset embedded sSATA controller.

### 6.3.1 Embedded RAID Support

RAID support from embedded RAID options for server board mounted M.2 SSDs is defined as follows:

- Neither Intel ESRT2 nor Intel® VROC (SATA RAID) have RAID support for PCIe M.2 SSDs when installed to the M.2 connectors on the server board.

---

**Note:** NVMe\* RAID support using Intel® VROC (VMD NVMe\* RAID) requires that the PCIe bus lanes be routed directly from the CPU. On this server board, the PCIe bus lanes routed to the onboard M.2 connectors are routed from the Intel chipset (PCH).

**Note:** The Intel ESRT2 option does not support PCIe devices.

---

- Both Intel ESRT2 and Intel® VROC (SATA RAID) provide RAID support for SATA devices (see Section 6.2).
- Neither embedded RAID option supports mixing of M.2 SATA SSDs and SATA hard drives within a single RAID volume.

---

**Note:** Storage devices used to create a single RAID volume created using either Intel® VROC (SATA RAID) or Intel ESRT2 cannot span across the two embedded SATA controllers nor is mixing both SATA and NVMe\* devices within a single RAID volume supported.

---

- The binary driver includes partial source files. The driver is fully open source using an MDRAID layer in Linux.

## 6.4 PCIe NVMe\* Drive Support

The R1208WFXXX models within the Intel Server System R1000WF product family have support for eight PCIe NVMe\* drives. Each installed NVMe\* drive must have its own PCIe interface as cabled to the backplane from one or more of the following PCIe signal sources:

- Onboard PCIe OCuLink\* connectors on the server board
- 4-port PCIe 3.0 x8 switch add-in card (accessory kit iPC – AXXP3SWX08040)
- 4-port PCIe 3.0 x16 retimer add-in card (accessory kit iPC – AXXP3RTX16040)

### 6.4.1 Onboard PCIe\* OCuLink\* Connectors

Depending on the model of the server board installed, the server board has two (S2600WFQR) or four (S2600WF0R and S2600WFTR) PCIe OCuLink\* connectors, each supporting a x4 PCIe signaling interface. When cabled to the backplane, each connector provides the PCIe interface to a single installed NVMe\* drive on the backplane.

PCIe signals for onboard OCuLink\* connectors “PCIe\_SSD0” and “PCIe\_SSD1” are routed directly from CPU\_1 and PCIe signals for OCuLink\* connectors “PCIe\_SSD2” and “PCIe\_SSD3” are directly routed from CPU\_2.

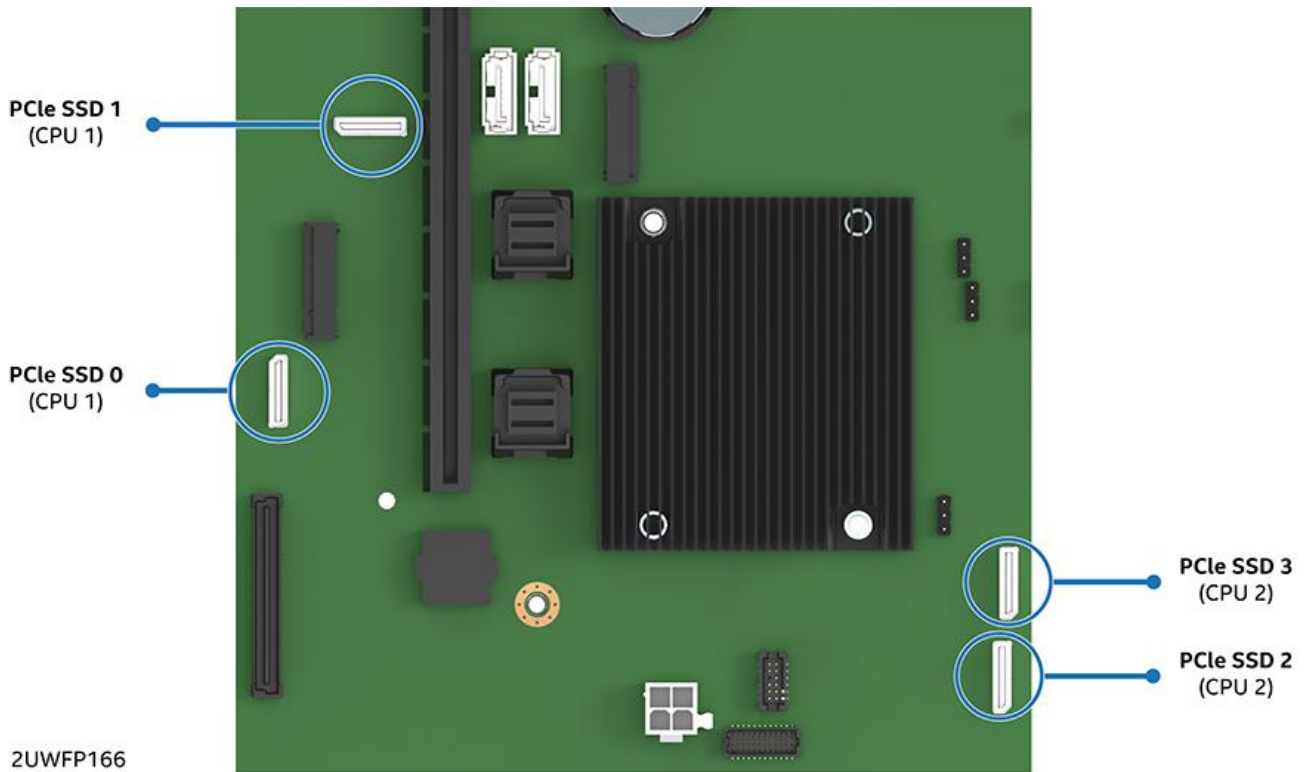
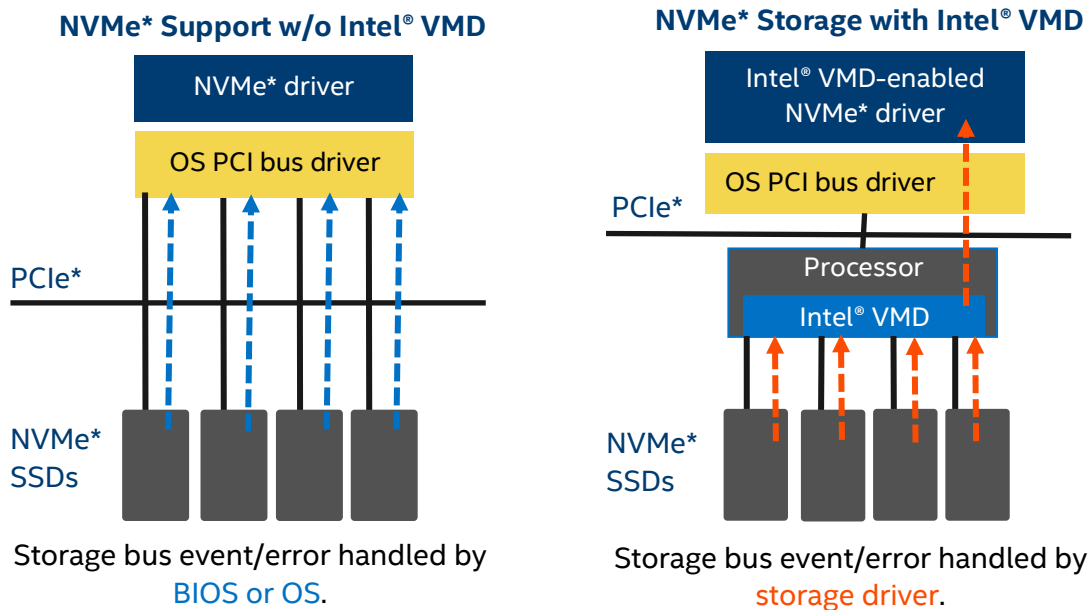


Figure 45. Onboard OCuLink\* connectors

### 6.4.2 Intel® Volume Management Device (Intel® VMD) for NVMe\*

Intel® Volume Management Device (Intel® VMD) is hardware logic inside the processor root complex to help manage PCIe NVMe\* SSDs. It provides robust hot plug support and status LED management. This allows servicing of storage system NVMe\* SSD media without fear of system crashes or hangs when ejecting or inserting NVMe\* SSD devices on the PCIe bus.



**Figure 46. NVMe\* storage bus event/error handling**

Intel VMD handles the physical management of NVMe\* storage devices as a stand-alone function but can be enhanced when Intel® VROC (VMD NVMe\* RAID) support options are enabled to implement RAID based storage systems. See Section 6.4.3 for more information.

Intel VROC (VMD NVMe\* RAID) includes the following features and capabilities:

- Hardware is integrated inside the processor PCIe root complex.
- Entire PCIe trees are mapped into their own address spaces (domains).
- Each domain manages x16 PCIe lanes.
- Can be enabled/disabled in BIOS setup at x4 lane granularity.
- Driver sets up/manages the domain (enumerate, event/error handling)
- May load an additional child device driver that is Intel VMD aware.
- Hot plug support - hot insert array of PCIe SSDs.
- Support for PCIe SSDs and switches only (no network interface controllers (NICs), graphics cards, etc.)
- Maximum of 128 PCIe bus numbers per domain.
- Support for MCTP over SMBus\* only.
- Support for MMIO only (no port-mapped I/O).
- Does not support NTB, Quick Data Tech, Intel® Omni-Path Architecture, or SR-IOV.
- Correctable errors do not bring down the system.
- Intel VMD only manages devices on PCIe lanes routed directly from the processor. Intel VMD cannot provide device management on PCI lanes routed from the chipset (PCH)
- When Intel VMD is enabled, the BIOS does not enumerate devices that are behind Intel VMD. The Intel VMD-enabled driver is responsible for enumerating these devices and exposing them to the host.
- Intel VMD supports hot-plug PCIe SSDs connected to switch downstream ports. Intel VMD does not support hot-plug of the switch itself.

#### 6.4.2.1 Enabling Intel® VMD support

For installed NVMe\* devices to use the Intel VMD features of the server board, Intel VMD must be enabled on the appropriate CPU PCIe root ports in BIOS setup. By default, Intel VMD support is disabled on all CPU PCIe root ports in BIOS setup.



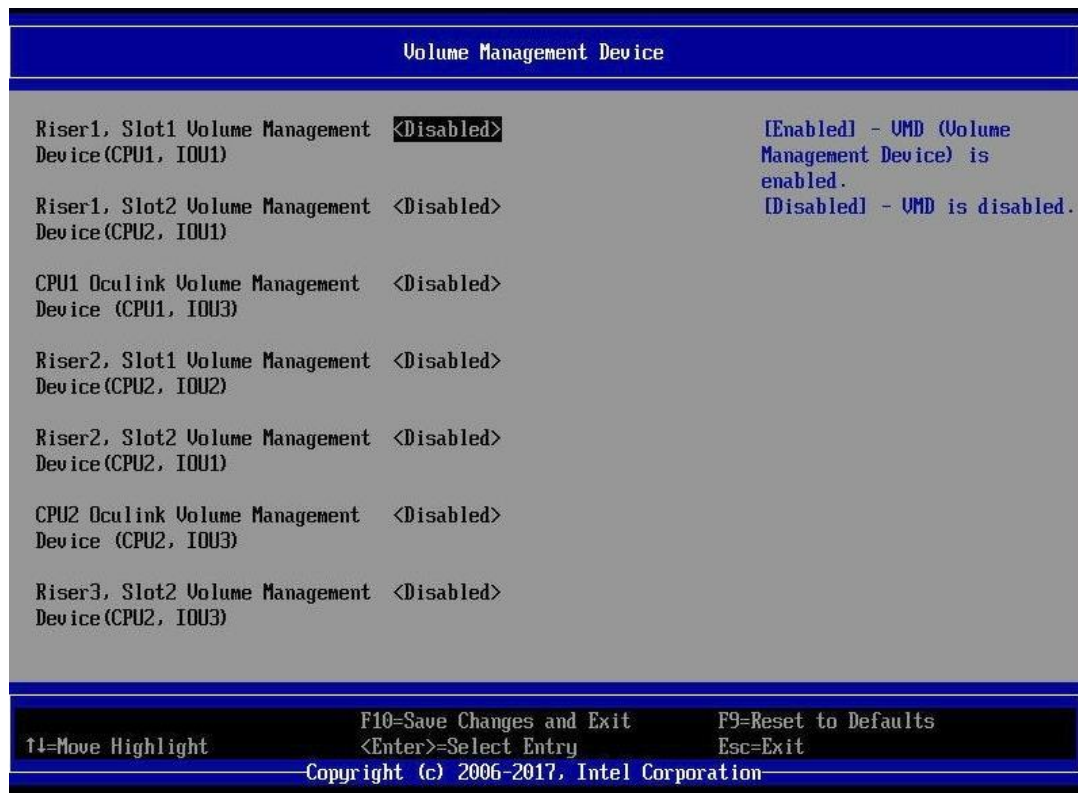
Table 45 provides the PCIe root port mapping for all onboard PCIe devices, OCuLink\* connectors and riser card slots.

**Table 45. CPU - PCIe\* port routing**

CPU 1		CPU 2	
PCI Ports	Onboard Device	PCI Ports	Onboard Device
Port DMI 3 - x4	Chipset	Port DMI 3 - x4	Riser Slot #3
Port 1A - x4	Riser Slot #1	Port 1A - x4	Riser Slot #2
Port 1B - x4	Riser Slot #1	Port 1B - x4	Riser Slot #2
Port 1C - x4	Riser Slot #1	Port 1C - x4	Riser Slot #1
Port 1D - x4	Riser Slot #1	Port 1D - x4	Riser Slot #1
Port 2A - x4	Chipset (PCH) - uplink	Port 2A - x4	Riser Slot #2
Port 2B - x4	Chipset (PCH) - uplink	Port 2B - x4	Riser Slot #2
Port 2C - x4	Chipset (PCH) - uplink	Port 2C - x4	Riser Slot #2
Port 2D - x4	Chipset (PCH) - uplink	Port 2D - x4	Riser Slot #2
Port 3A - x4	SAS Module	Port 3A - x4	OCuLink PCIe_SSD2
Port 3B - x4	SAS Module	Port 3B - x4	OCuLink PCIe_SSD3
Port 3C - x4	OCuLink PCIe_SSD0	Port 3C - x4	Riser Slot #3
Port 3D - x4	OCuLink PCIe_SSD1	Port 3D - x4	Riser Slot #3

For PCIe add-in card slot root port mapping associated with each riser slot, see Table 49.

In BIOS setup, the Intel VMD support menu can be found **Advanced > PCI Configuration > Volume Management Device**.



**Figure 47. Intel® VMD support disabled in BIOS setup**

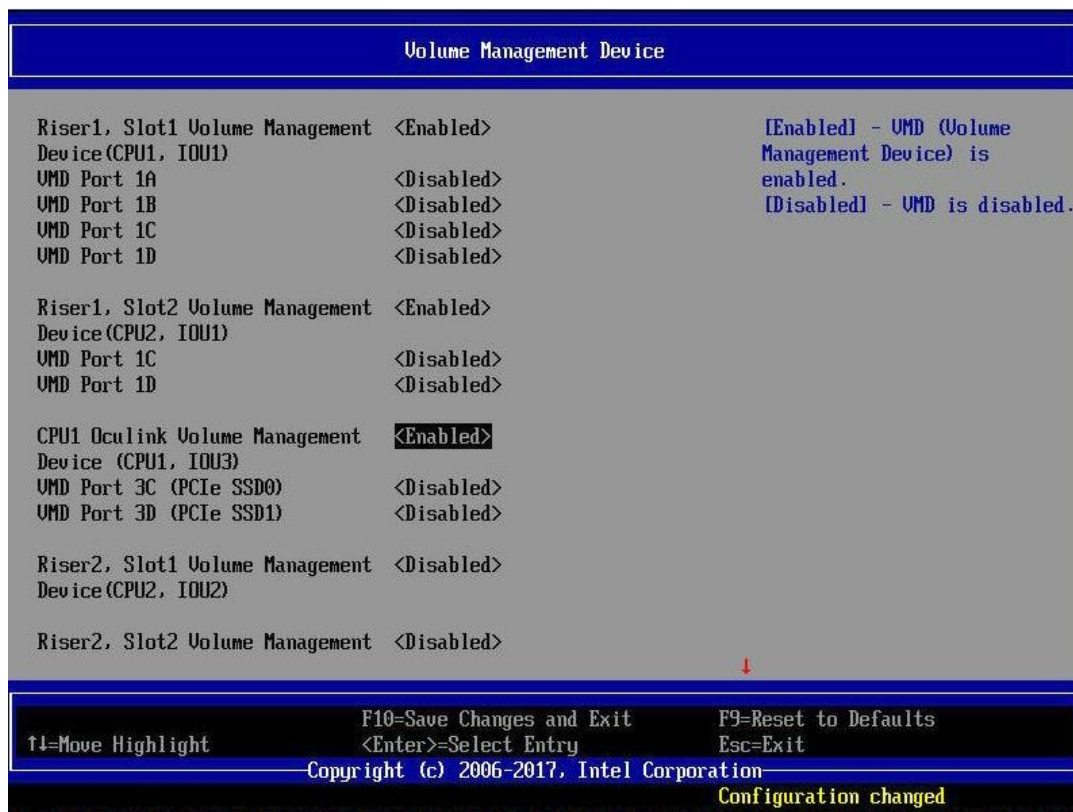


Figure 48. Intel® VMD support enabled in BIOS setup

### 6.4.3 Intel® Virtual RAID on CPU (Intel® VROC) VMD NVMe\* RAID 6.0

Intel VROC (VMD NVMe\* RAID) 6.0 enables NVMe\* boot on RAID and volume management

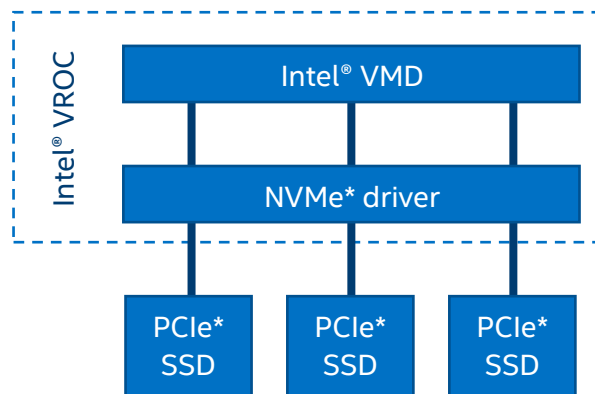


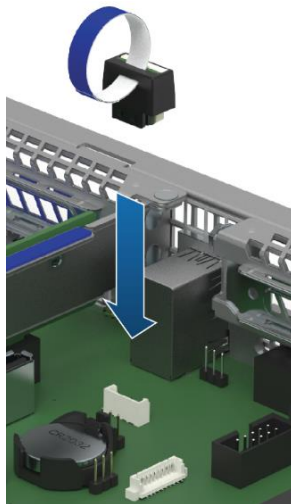
Figure 49. Intel® VROC (VMD NVMe\* RAID) basic architecture overview

Intel VROC (VMD NVMe\* RAID) supports the following:

- I/O processor with controller (ROC) and DRAM.
- No need for battery backup / RAID maintenance free backup unit.
- Protected write-back cache – software and hardware that allows recovery from a double fault.
- Isolated storage devices from OS for error handling.
- Protected R5 data from OS crash.
- Boot from RAID volumes based on NVMe\* SSDs within a single Intel VMD domain.
- NVMe\* SSD hot plug and surprise removal on CPU PCIe lanes.
- LED management for CPU PCIe attached storage.

- RAID / storage management using representational state transfer (RESTful) application programming interfaces (APIs).
- Graphical user interface (GUI) for Linux.
- 4K built-in NVMe\* SSD support.

Enabling Intel VROC support requires installation of an optional upgrade key on to the server board as shown in Figure 50. Table 46 identifies available Intel VROC upgrade key options.



**Figure 50. Intel® VROC upgrade key**

**Note:** The onboard connector used to provide support for the Intel® VROC (VMD NVMe\* RAID) upgrade key options is also used to support the Intel® ESRT2 SATA RAID-5 upgrade key.

**Table 46. Intel® VROC upgrade key options**

NVMe* RAID Major Features	Standard Intel® VROC (iPC VROCSTANMOD)	Premium Intel® VROC (iPC VROCPREMMOD)
CPU attached NVMe* SSD – high perf.	✓	✓
Boot on RAID volume	✓	✓
Third party vendor SSD support	✓	✓
RAID 0/1/10	✓	✓
RAID 0/1/5/10	-	✓
RAID write hole closed (RMFBU replacement)	-	✓
Hot plug/ surprise removal (2.5" SSD form factor only)	✓	✓
Enclosure LED management	✓	✓

**Note:** Intel® VROC Upgrade Keys referenced in Table 46 are used for PCIe NVMe\* SSDs only. For SATA RAID support, see Section 6.2.

#### 6.4.4 NVMe\* Drive Population Rules for Intel® VROC

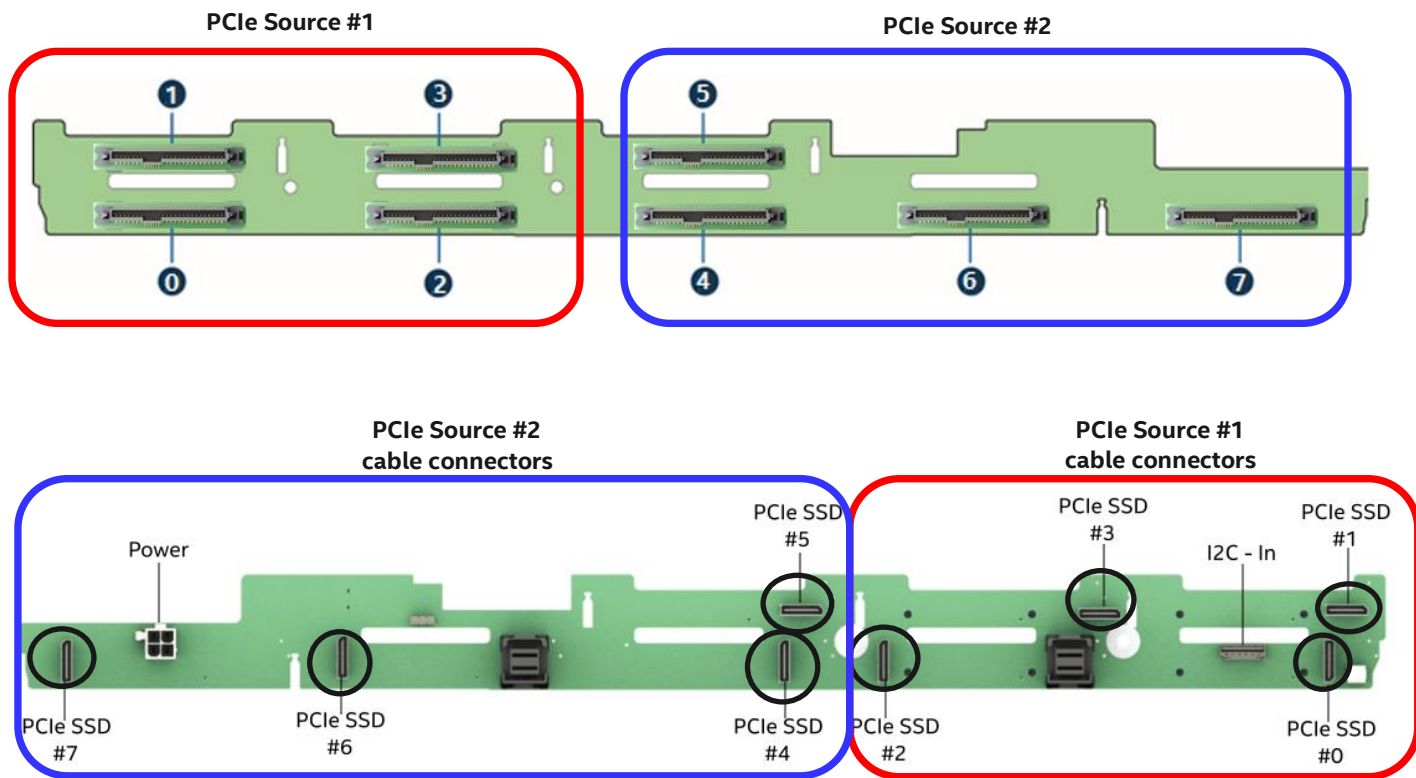
In order to support NVMe\* RAID and NVMe\* management features, the optional Intel VROC Key must be installed on to the server board. With the Intel VROC key installed, specific drive population rules exist and must be followed for proper support of the NVMe\* management features.

The backplane can support PCIe interfaces from the onboard OcuLink\* connectors on the server board, and/or optional add-in tri-mode Intel RAID modules, PCIe switch cards and Retimer cards. When cabling the PCIe interfaces from two different PCIe interface sources to the backplane, the cables from each source must be connected in defined drive sets of four (0-3) and (4-7) as shown in Figure 51.

---

**Note:** The use of one or more OcuLink\* connectors on the server board to the backplane is considered a single source.

---



**Figure 51. Backplane cabling from two PCIe\* sources**

When cabling the backplane from two different PCIe sources, no other drive set combinations beyond those defined above are supported.

Drive population rules differ depending on the source of the PCIe interface to the backplane. In addition, specific drive population limits exist when populating a backplane with both NVMe\* and SAS drive types. The following sections define the drive population rules associated with each of the available PCIe sources to the backplane.

---

**Note:** When connecting the backplane to two different PCIe sources, the defined population rules for each PCIe source are applied to the drive set connected to it.

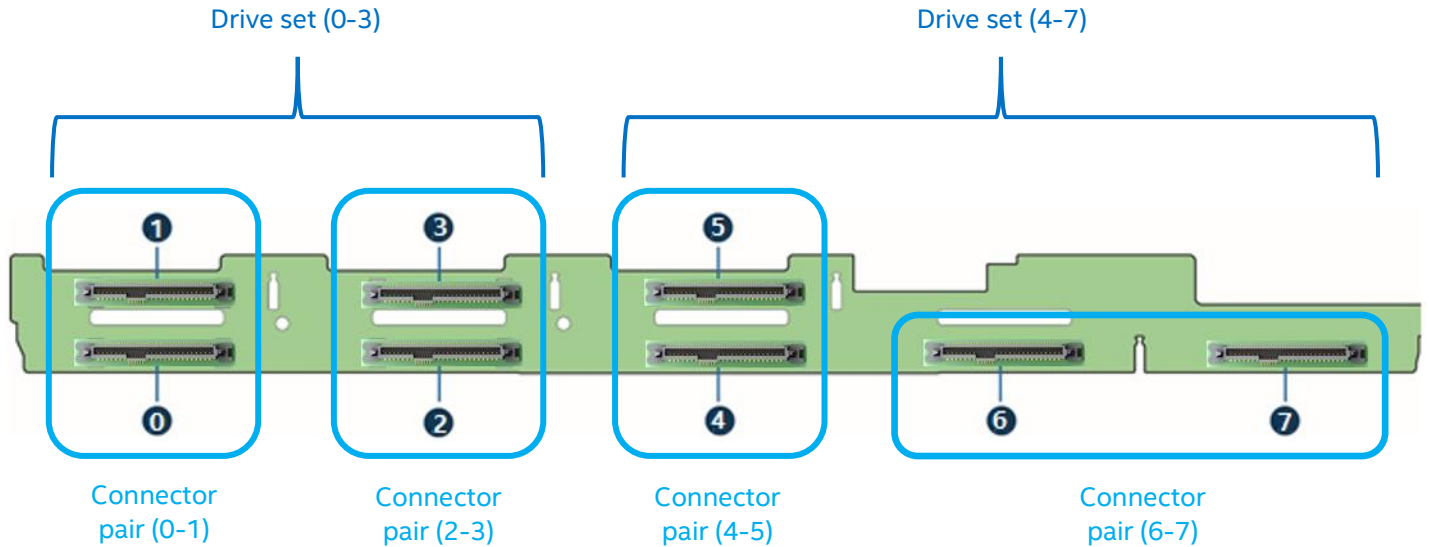
---

#### 6.4.4.1 Onboard PCIe\* OcuLink\* Connectors to 8 x 2.5" Combo Backplane

The following information is applicable when PCIe\* signals to the 8x2.5" combo backplane are cabled from the PCIe\* OcuLink\* connectors on the server board.

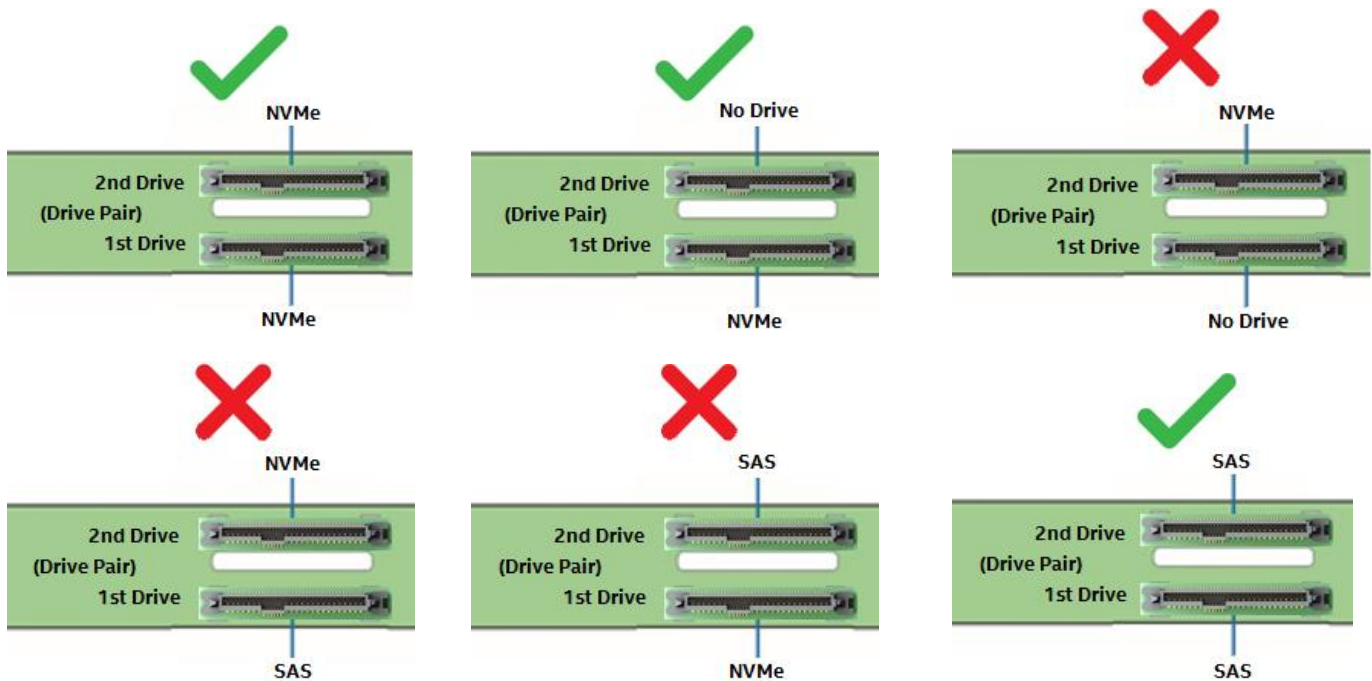
- OcuLink\* connectors on the server board are considered a single PCIe source to the backplane, and therefore can only be connected in defined drive sets (0-3) or (4-7).
- NVMe\* drive management sideband signals on the backplane are routed between drive connector pairs (0-1), (2-3), (4-5), and (6-7).

- In order to support NVMe\* drive management within a defined drive pair, an NVMe\* drive must be populated in the first drive connector of the given pair (connector 0, 2, 4, or 6).
- Combining an NVMe\* drive with a SAS/SATA drive within a defined drive pair is not supported.
  - Example: With an NVMe\* drive installed to drive connector 0, drive connector 1 cannot be populated with a SAS/SATA drive. The same rule applies to all other drive pairs on the backplane.



**Figure 52. Drive set and connector identification**

Figure 53 identifies supported and unsupported drive populations associated with any defined drive pair of the 8x2.5" combo backplane when Intel VROC is used for NVMe\* drive management and the PCIe source to the backplane is from any of the onboard OCuLink\* connectors.

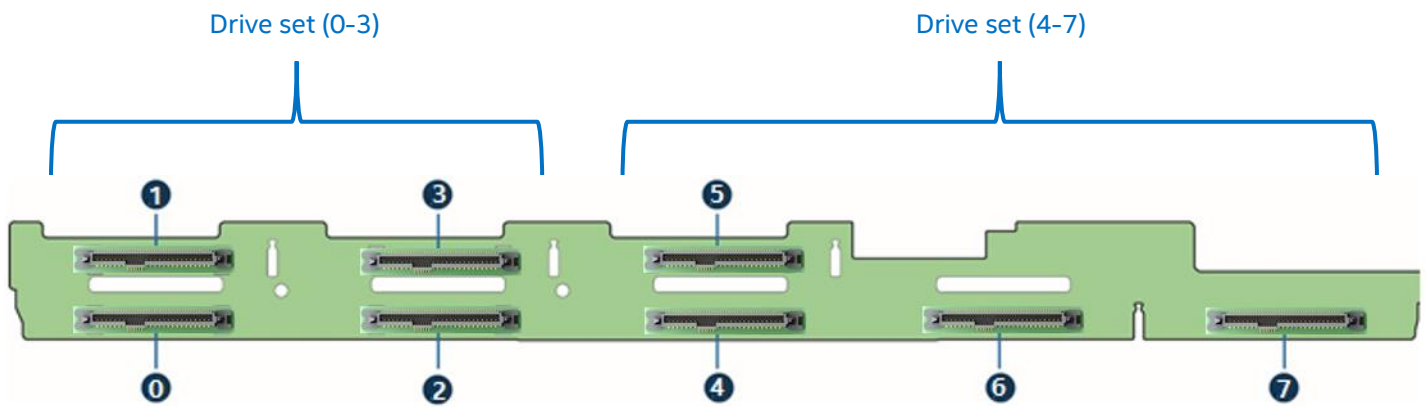


**Figure 53. Supported drive population for onboard OCuLink\* connectors**

#### 6.4.4.2 4-Port PCIe\* Switch to 8 x 2.5" Combo Backplane

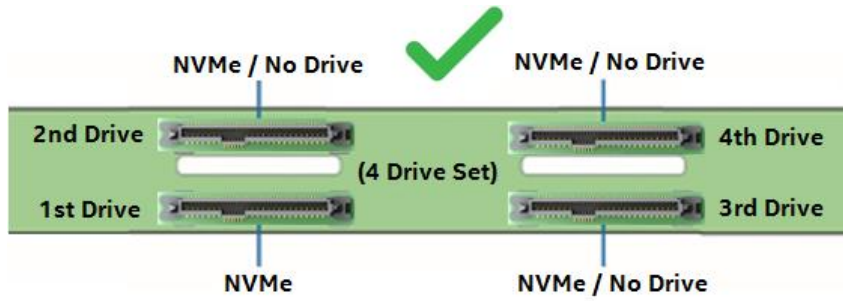
The following information is applicable when PCIe signals to the 8 x 2.5" combo backplane are cabled from 4-port PCIe switch add-in cards.

- NVMe\* drive management sideband signals on the backplane are routed between drive connector sets (0-3) and (4-7).
- In order to support NVMe\* drive management within a defined drive set, an NVMe\* drive must be populated in the first drive connector of the given set (drive connector 0 or 4). Additional NVMe\* drives within the drive set must be populated in sequential order with no gaps between drive connectors.
- Combining NVMe\* drives and SAS/SATA drives within a defined drive set is not supported.

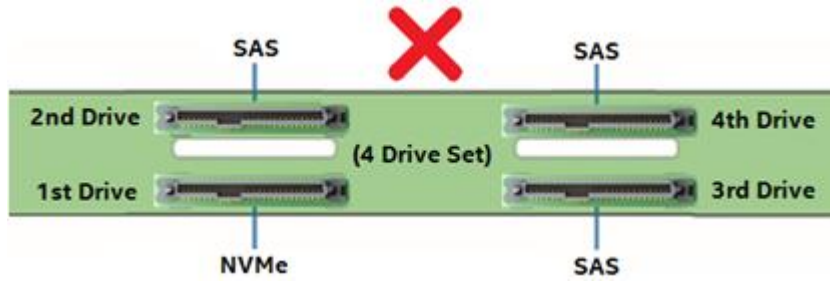


**Figure 54. Drive set and connector identification**

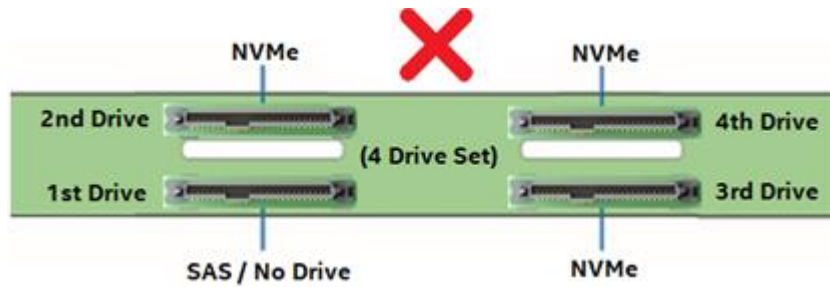
Figure 55 identifies supported and unsupported drive populations associated with any defined drive set of the 8 x 2.5" combo backplane when an Intel VROC key is installed to the server board and the PCIe source to the backplane is from an add-in PCIe switch card.



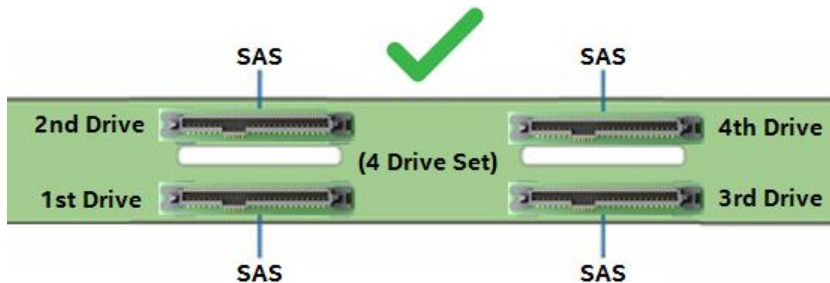
First drive = NVMe  
and  
NVMe\* in any sequential drive slot (no gaps)



Mixing of NVMe\* and SAS within a common drive set is not supported



No NVMe\* drive in first drive slot and mixing of NVMe\* and SAS within a common drive set is not supported



SAS in all 4 drive slots,  
no NVMe\* drive

Figure 55. Supported drive population for 4- or 8-port PCIe\*switch

## 6.5 Intel® Integrated RAID Module Support

The system has support for many Intel and non-Intel PCIe add-in 12 Gb RAID adapters that can be installed in available PCIe add-in cards slots. For system configurations with limited add-in card slot availability, an optional Intel® Integrated RAID mezzanine module can be installed onto a high density 80-pin connector labeled “SAS Module” on the server board.

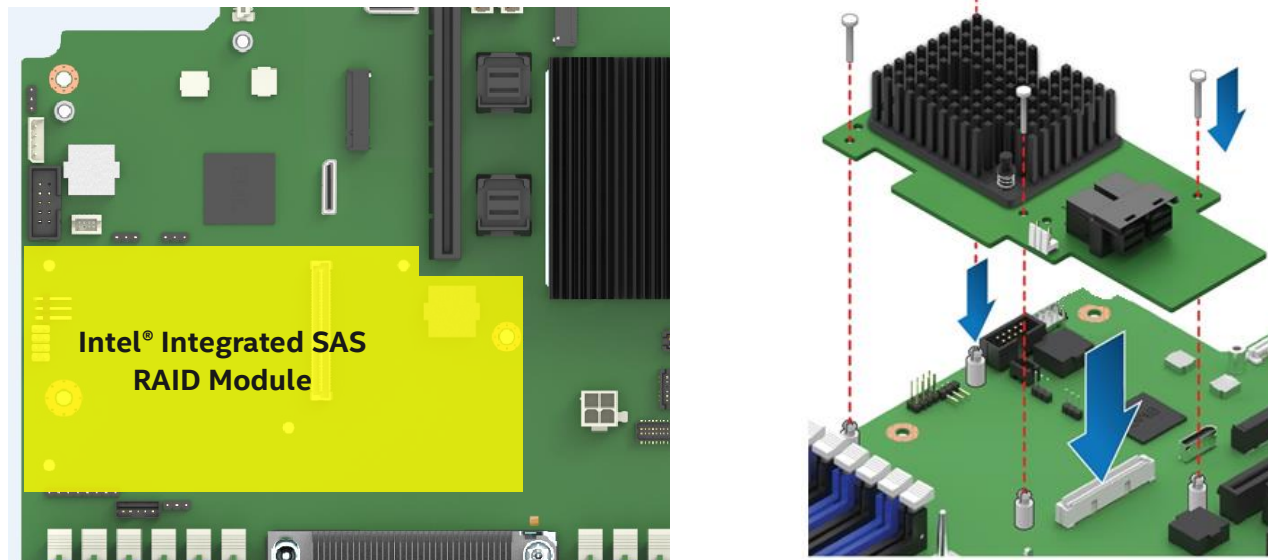


Figure 56. Intel® Integrated RAID Module

For a list of supported Intel Integrated RAID Module options, visit the Intel® Server Configurator Tool at <https://serverconfigurator.intel.com>.

---

**Note:** Intel® Integrated RAID modules cannot be supported in systems configured with a CPU #1 processor that supports the Intel® Omni-Path Fabric connector.

---



### 6.5.1 RAID Maintenance Free Backup Unit (RMFBU) Support

The 1U system has support for one or two RAID maintenance free backup units (RMFBUs).



Figure 57. Support for single RMFBU (standard option)

Support for two RMFBUs will require the use of an optional bracket (iPC – AWTAXBBUBKT) capable of supporting stacked RMFBUs.



WTPC106

Figure 58. Support for dual RMFBUs (optional accessory)

## 7. Front Control Panel and I/O Panel Overview

All system configurations include an I/O panel and control panel on the front of the system. This section describes the features and functions of both.

### 7.1 I/O Panel Features

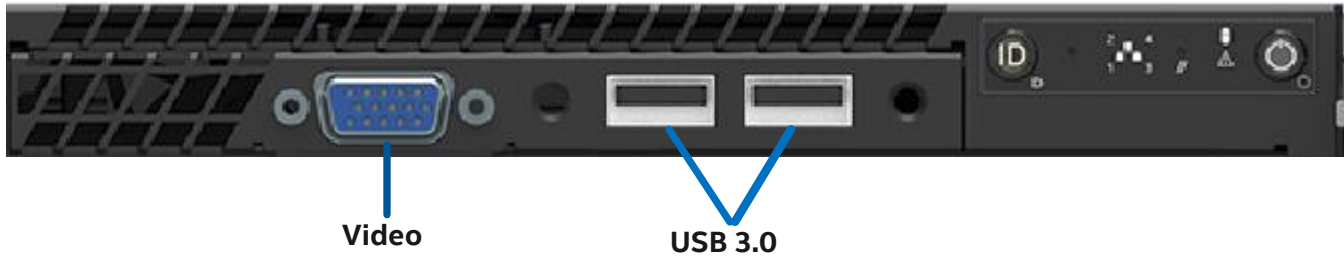


Figure 59. Front I/O panel features

- **Video connector** – The front I/O panel video connector gives the option of attaching a monitor to the front of the system. When BIOS detects that a monitor is attached to the front video connector, it disables the video signals routed to the onboard video connector on the back of the system. Video resolution from the front video connector may be lower than that of the rear onboard video connector. A short video cable should be used for best resolution. The front video connector is cabled to a 2x7 header on the server board labeled “FP Video”.
- **USB 2.0/3.0 Ports** –The front I/O panel includes two USB 2.0/3.0 ports. The USB ports are cabled to a blue 2x5 connector on the server board labeled “FP\_USB”.

**Note:** Due to signal strength limits associated with USB 3.0 ports cabled to a front panel, some marginally compliant USB 3.0 devices may not be supported from these ports. In addition, server systems based on the Intel® Server Board S2600WF cannot be USB 3.0 certified with USB 3.0 ports cabled to a front panel.

### 7.2 Control Panel Features

The system includes a control panel that provides push button system controls and LED indicators for several system features. This section provides a description for each front control panel feature.

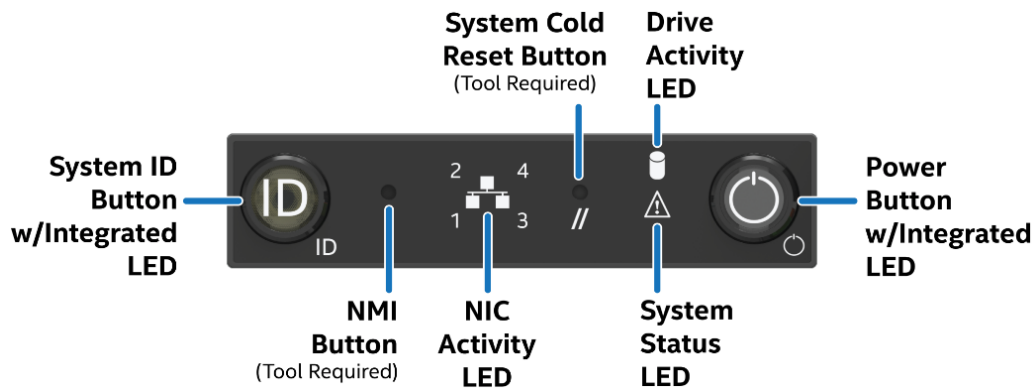


Figure 60. Front control panel features

- **System ID button w/ integrated LED** – Toggles the integrated ID LED and the blue server board ID LED on and off. The system ID LED is used to identify the system for maintenance when installed in a rack of similar server systems. The system ID LED can also be toggled on and off remotely using the IPMI “Chassis Identify” command, which causes the LED to blink for 15 seconds.

- **NMI Button** – When the NMI button is pressed, it puts the server in a halt state and issues a non-maskable interrupt (NMI). This can be useful when performing diagnostics for a given issue where a memory download is necessary to help determine the cause of the problem. To prevent an inadvertent system halt, the actual NMI button is located behind the front control panel faceplate where it is only accessible with the use of a small-tipped tool like a pin or paper clip.
- **Network activity LEDs** – The front control panel includes an activity LED indicator for each onboard Network Interface Controller (NIC). When a network link is detected, the LED turns on solid. The LED blinks when network activity occurs at a rate that is consistent with the amount of network activity that is occurring.
- **System cold reset button** – When pressed, this button reboots and re-initializes the system. To prevent an inadvertent system reset, the actual reset button is located behind the front control panel faceplate where it is only accessible with the use of a small-tipped tool like a pin or paper clip.
- **System status LED** – The system status LED is a bi-color (green/amber) indicator that shows the current health of the server system. The system provides two locations for this feature; one is on the front control panel and the other is on the back edge of the server board, viewable from the back of the system. Both LEDs are tied together and show the same state. The system status LED states are driven by the onboard platform management subsystem. The following table provides a description of each supported LED state.

**Table 47. System status LED state definitions**

LED State	System State	BIOS Status Description
Off	System is not operating.	<ul style="list-style-type: none"> <li>• System AC power is off.</li> <li>• System is in EuP Lot6 off mode.</li> </ul>
Solid green	System is operating normally.	<ul style="list-style-type: none"> <li>• System is running (in S0 State) and its status is healthy. The system is not exhibiting any errors. AC power is present, the BMC has booted, and manageability functionality is up and running.</li> <li>• After a BMC reset, and in conjunction with the chassis ID solid on, the BMC is booting Linux*. Control has been passed from BMC uBoot to BMC Linux* itself. It is in this state for roughly 10–20 seconds.</li> <li>• System is in S5 soft-off state.</li> </ul>

LED State	System State	BIOS Status Description
Blinking green	System is operating in a degraded state although still functioning, or system is operating in a redundant state but with an impending failure warning.	<ul style="list-style-type: none"> <li>• Redundancy loss such as power-supply or fan. Applies only if the associated platform subsystem has redundancy capabilities.</li> <li>• Fan warning or failure when the number of fully operational fans is less than the minimum number needed to cool the system.</li> <li>• Non-critical threshold crossed – Temperature (including HSBP temp), voltage, input power to power supply, output current for main power rail from power supply and Processor Thermal Control (Therm Ctrl) sensors.</li> <li>• Power supply predictive failure occurred while redundant power supply configuration was present.</li> <li>• Unable to use all of the installed memory (more than 1 DIMM installed).</li> <li>• Correctable Errors over a threshold and migrating to a spare DIMM (memory sparing). This indicates that the system no longer has spared DIMMs (a redundancy lost condition). Corresponding DIMM LED lit.</li> <li>• In mirrored configuration, when memory mirroring takes place and system loses memory redundancy.</li> <li>• Battery failure.</li> <li>• BMC executing in uBoot. (Indicated by Chassis ID blinking at 3Hz). System in degraded state (no manageability). BMC uBoot is running but has not transferred control to BMC Linux*. Server will be in this state 6–8 seconds after BMC reset while it pulls the Linux* image into flash.</li> <li>• BMC Watchdog has reset the BMC.</li> <li>• Power Unit sensor offset for configuration error is asserted.</li> <li>• HDD HSC is off-line or degraded.</li> </ul>
Blinking amber	System is operating in a degraded state with an impending failure warning, although still functioning. System is likely to fail.	<ul style="list-style-type: none"> <li>• Critical threshold crossed – Voltage, temperature (including HSBP temp), input power to power supply, output current for main power rail from power supply and PROCHOT (Therm Ctrl) sensors.</li> <li>• VRD Hot asserted.</li> <li>• Minimum number of fans to cool the system not present or failed.</li> <li>• Hard drive fault.</li> <li>• Power Unit Redundancy sensor – Insufficient resources offset (indicates not enough power supplies present).</li> <li>• In non-sparing and non-mirroring mode if the threshold of correctable errors is crossed within the window.</li> </ul>

LED State	System State	BIOS Status Description
Solid amber	Critical/non-recoverable – system is halted. Fatal alarm – system has failed or shut down.	<ul style="list-style-type: none"> <li>• CPU CATERR signal asserted.</li> <li>• MSID mismatch detected (CATERR also asserts for this case).</li> <li>• CPU 1 is missing.</li> <li>• CPU Thermal Trip.</li> <li>• No power good – power fault.</li> <li>• DIMM failure when there is only 1 DIMM present and hence no good memory present.</li> <li>• Runtime memory uncorrectable error in non-redundant mode.</li> <li>• DIMM Thermal Trip or equivalent.</li> <li>• SSB Thermal Trip or equivalent.</li> <li>• CPU ERR2 signal asserted.</li> <li>• BMC/Video memory test failed. (Chassis ID shows blue/solid-on for this condition.)</li> <li>• Both uBoot BMC firmware images are bad. (Chassis ID shows blue/solid-on for this condition.)</li> <li>• 240 VA fault.</li> <li>• Fatal Error in processor initialization: <ul style="list-style-type: none"> <li>○ Processor family not identical</li> <li>○ Processor model not identical</li> <li>○ Processor core/thread counts not identical</li> <li>○ Processor cache size not identical</li> <li>○ Unable to synchronize processor frequency</li> <li>○ Unable to synchronize QPI link frequency</li> </ul> </li> <li>• Uncorrectable memory error in a non-redundant mode.</li> </ul>

- **Power/sleep button** – Toggles the system power on and off. This button also functions as a sleep button if enabled by an ACPI compliant operating system. Pressing this button sends a signal to the Integrated BMC, which either powers on or powers off the system. The integrated LED is a single color (green) and can support different indicator states as defined in the following table.

**Table 48. Power/sleep LED functional states**

Power Mode	LED	System State	Description
Non-ACPI	Off	Power-off	System power is off and the BIOS has not initialized the chipset.
	On	Power-on	System power is on
ACPI	Off	S5	Mechanical is off and the operating system has not saved any context to the hard disk.
	On	S0	System and the operating system are up and running.

- **Drive activity LED** - The drive activity LED on the front panel indicates drive activity from the onboard storage controllers. The server board also provides a header giving access to this LED for add-in controllers.

## 8. PCIe\* Riser Card Support

The server board provides three riser card slots identified as Riser Slot #1, Riser Slot #2, and Riser Slot #3. In a 1U system, PCIe\* add-in cards can only be installed into single slot riser cards installed to riser slots #1 and #2. Riser slot #3 is not supported in a 1U system. Per the PCIe specification, each riser card slot can support a maximum 75 W of power. The PCIe bus lanes for each riser card slot is supported by each of the two installed processors. Table 49 provides the PCIe\* bus routing for all supported riser cards.

### Notes:

The riser card slots are specifically designed to support riser cards only. Attempting to install a PCIe add-in card directly into a riser card slot on the server board may damage the server board, the add-in card, or both. A dual processor configuration is required when using Riser Slot #2.

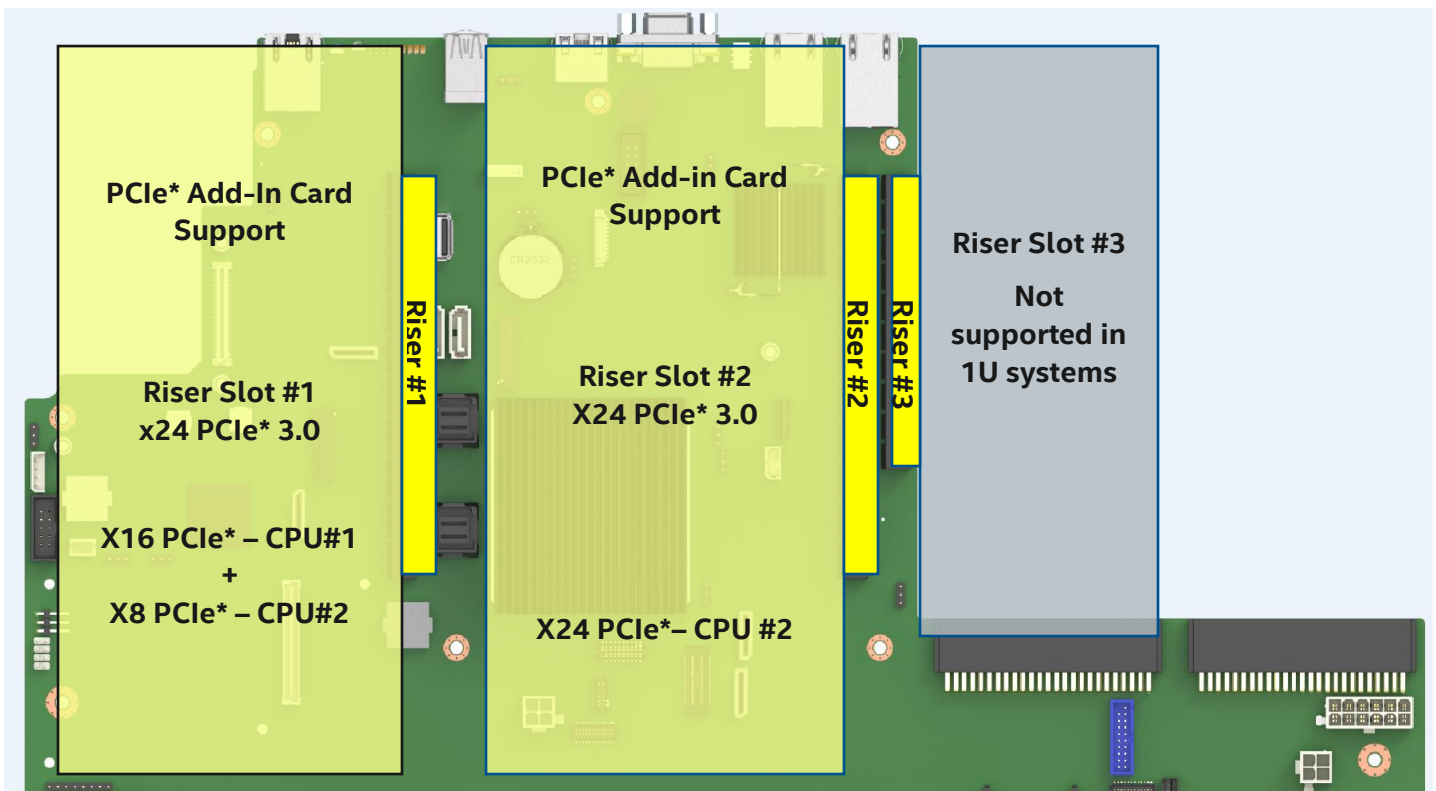


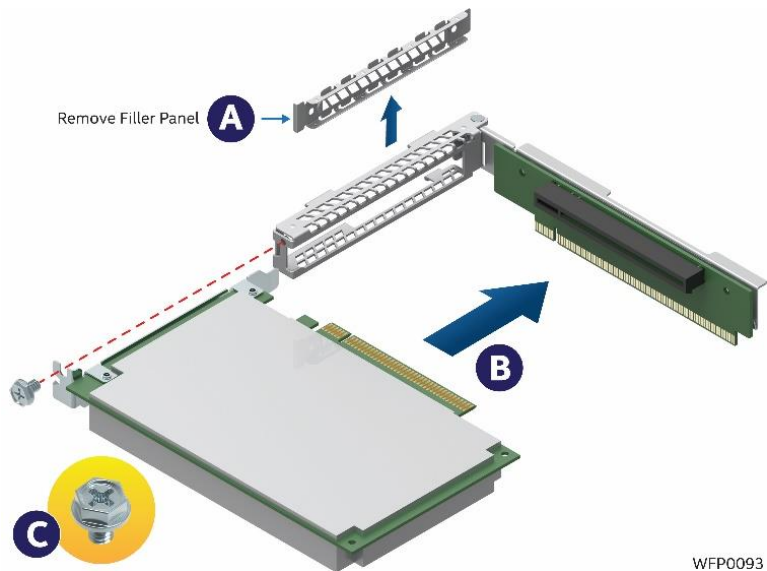
Figure 61. PCIe\* add-in card support

Table 49. Riser slot #1 and riser slot #2 PCIe\* root port mapping

PCIe* Riser Slot	1U – 1-Slot Riser Card iPC – F1UL16RISER3APP
Riser slot #1	CPU #1 – Ports 1A through 1D (x16 elec, x16 mech)
Riser slot #2	CPU #2 – Ports 2A through 2D (x16 elec, x16 mech)

## 8.1 Riser Card Assembly

Each riser card is mounted to a bracket assembly, which is inserted into a riser card slot on the server board.



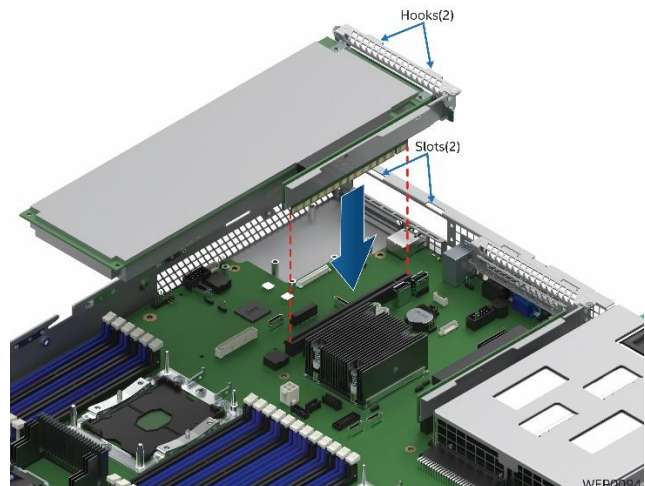
**Figure 62. Riser card assembly**

Each riser card assembly has support for a single full height, ½ length PCIe\* add-in card.

---

**Note:** Add-in cards that exceed the PCI specification for ½ length PCI add-in cards (167.65mm or 6.6in) may interfere with other installed devices on the server board.

---



**Figure 63. Add-in card support**

## 8.2 1U Riser Card



**Figure 64. 1U one-slot PCIe\* riser card (iPC – F1UL16RISER3)**



## 9. Intel® Ethernet Network Adapter for OCP\* Support

To broaden the standard onboard feature set, the server board supports one of several available Intel® Ethernet Network Adapters compatible with the Open Compute Project\* (OCP\*) specification. The OCP-compatible modules are mounted to a high density 120-pin connector on the server board labeled “OCP\_IO\_Module”.

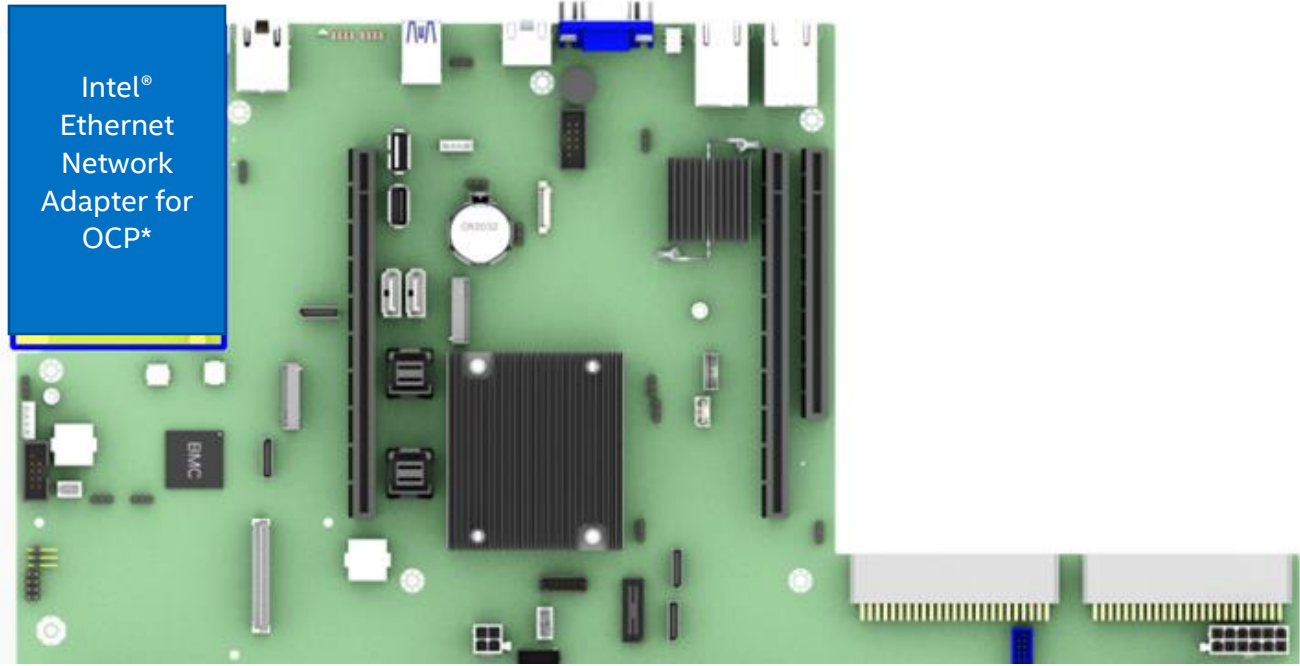


Figure 65. Intel® Ethernet Network Adapter for OCP\* placement

Table 50 lists the supported OCP modules:

Table 50. Supported Intel® Ethernet Network Adapters for OCP\*

Description	iPC
Quad Port, 1GB, RJ45	I357T4OCPG1P5
Quad Port, SFP+	X527DA4OCPG1P5
Dual Port, SFP+ (Intel® Server Board S2600WFTR only)	X527DA2OCPG1P5
Dual Port, 10Gb RJ45 (Intel® Server Board S2600WFTR only)	X557T2OCPG1P5

**Note:** The quad-port SFP+ and quad-port 10 Gb RJ45 modules are only supported on the Intel Server Board S2600WF0(R) and Intel Server Board S2600WFQ(R)

## 10. Basic and Advanced Server Management Features

The Integrated BMC has support for basic and advanced server management features. Basic management features are available by default. Advanced management features are enabled with the addition of an optionally installed Intel® Remote Management Module 4 Lite (Intel® RMM4 Lite) key.

**Table 51. Intel® Remote Management Module 4 (Intel® RMM4) options**

Intel Product Code (iPC)	Description	Kit Contents	Benefits
AXXRMM4LITE2	Intel® Remote Management Module 4 Lite	Intel® RMM4 Lite Activation Key	Enables keyboard, video, and mouse (KVM) and media redirection

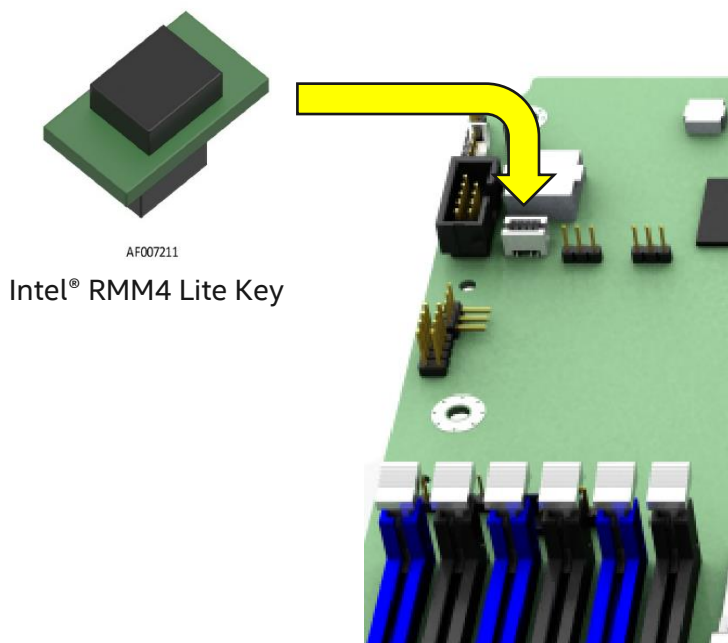
When the BMC firmware initializes, it attempts to access the Intel RMM4 Lite. If the attempt to access the Intel RMM4 Lite is successful, then the BMC activates the advanced features.

Table 52 identifies both basic and advanced server management features.

**Table 52. Basic and advanced server management features overview**

Feature	Basic	Advanced w/ Intel® RMM4 Lite Key
IPMI 2.0 feature support	X	X
In-circuit BMC firmware update	X	X
FRB-2	X	X
Chassis intrusion detection	X	X
Fan redundancy monitoring	X	X
Hot-swap fan support	X	X
Acoustic management	X	X
Diagnostic beep code support	X	X
Power state retention	X	X
ARP/DHCP support	X	X
PECI thermal management support	X	X
Email alerting	X	X
Embedded web server	X	X
SSH support	X	X
Integrated KVM		X
Integrated remote media redirection		X
Lightweight Directory Access Protocol (LDAP)	X	X
Intel® Intelligent Power Node Manager support	X	X
SMASH CLP	X	X

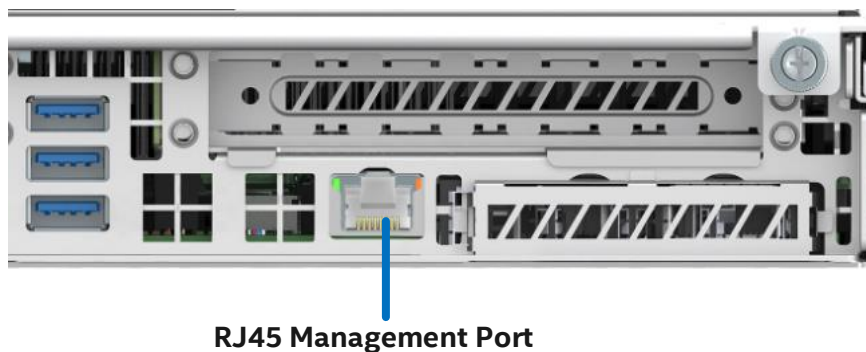
On the server board, the Intel RMM4 Lite key is installed at the location shown in Figure 66



**Figure 66. Intel® RMM4 Lite activation key placement**

## 10.1 Dedicated Management Port

The server board includes a dedicated 1 GbE, RJ45 management port. The management port is active with or without the Intel RMM4 Lite key installed.



**Figure 67. Dedicated management port**

## 10.2 Embedded Web Server

BMC base manageability provides an embedded web server and an OEM-customizable web GUI, which exposes the manageability features of the BMC base feature set. It is supported over all onboard NICs that have management connectivity to the BMC, as well as an optional dedicated add-in management NIC. At least two concurrent web sessions from up to two different users is supported. The embedded web user interface supports the following client web browsers:

- Microsoft Internet Explorer\*
- Mozilla Firefox\*
- Google Chrome\*
- Safari\*

The embedded web user interface supports strong security – authentication, encryption, and firewall support – since it enables remote server configuration and control. Encryption using 128-bit SSL is supported. User authentication is based on user ID and password.

The user interface presented by the embedded web server authenticates the user before allowing a web session to be initiated. It presents all functions to all users but grays out those functions that the user does not have privilege to execute. For example, if a user does not have privilege to power control, then the item is disabled and displayed in grey font in that user's display. The web interface also provides a launch point for some of the advanced features, such as keyboard, video, and mouse (KVM) and media redirection. These features are grayed out in the GUI unless the system has been updated to support these advanced features. The embedded web server only displays US English or Chinese language output.

Additionally, the web interface can:

- Present all the basic features to the users.
- Power on, power off, and reset the server and view current power state.
- Display BIOS, BMC, ME and SDR version information
- Display overall system health.
- Display configuration of various IPMI over LAN parameters for both IPV4 and IPV6.
- Display configuration of alerts (SNMP and SMTP).
- Display system asset information for the product, board, and chassis.
- Display BMC-owned sensors (name, status, current reading, enabled thresholds), including color-code status of sensors.
- Provide ability to filter sensors based on sensor type (voltage, temperature, fan, and power supply related).
- Automatically refresh sensor data with a configurable refresh rate.
- Provide online help
- Display/clear SEL (display is in easily understandable human readable format).
- Support major industry-standard browsers (Microsoft Internet Explorer\* and Mozilla Firefox\*).
- Automatically time out GUI session after a user-configurable inactivity period. By default, this inactivity period is 30 minutes.
- Provide embedded platform debug feature, allowing the user to initiate a “debug dump” to a file that can be sent to Intel for debug purposes.
- Provide a virtual front panel with the same functionality as the local front panel. The displayed LEDs match the current state of the local panel LEDs. The displayed buttons (for example, power button) can be used in the same manner as the local buttons.
- Display Intel ME sensor data. Only sensors that have associated SDRs loaded are displayed.
- Save the SEL to a file.
- Force HTTPS connectivity for greater security. This is provided through a configuration option in the user interface.
- Display processor and memory information that is available over IPMI over LAN.
- Get and set Intel® Node Manager (Intel® NM) power policies
- Display the power consumed by the server.
- View and configure VLAN settings.
- Warn user that the reconfiguration of IP address causes disconnection.
- Block logins for a period after several consecutive failed login attempts. The lock-out period and the number of failed logins that initiates the lock-out period are configurable by the user.
- Force into BIOS setup on a reset (server power control).
- Provide the system's power-on self-test (POST) sequence for the previous two boot cycles, including time stamps. The time stamps may be displayed as a time relative to the start of POST or the previous POST code.

- Provide the ability to customize the port numbers used for SMASH, http, https, KVM, secure KVM, remote media, and secure remote media.

For additional information, refer to the *Intel® Remote Management Module 4 and Integrated BMC Web Console User Guide*.

## 10.3 Advanced Management Feature Support

The integrated baseboard management controller has support for advanced management features, which are enabled when an optional Intel RMM4 Lite is installed. The Intel RMM4 Lite add-on offers convenient, remote KVM access and control through LAN and internet. It captures, digitizes, and compresses video and transmits it with keyboard and mouse signals to and from a remote computer. Remote access and control software runs in the integrated baseboard management controller, using expanded capabilities enabled by the Intel RMM4 Lite hardware.

Key features of the Intel RMM4 Lite add-on include:

- **KVM redirection** from either the dedicated management NIC or the server board NICs used for management traffic and up to two KVM sessions. KVM automatically senses video resolution for best possible screenshot, high performance mouse tracking, and synchronization. It allows remote viewing and configuration in pre-boot POST and BIOS setup.
- **Media redirection** intended to allow system administrators or users to mount a remote IDE or USB CD-ROM, floppy drive, or a USB flash disk as a remote device to the server. Once mounted, the remote device appears to the server just like a local device, allowing system administrators or users to install software (including operating systems), copy files, update BIOS, or boot the server from this device.

### 10.3.1 Keyboard, Video, Mouse (KVM) Redirection

The BMC firmware supports keyboard, video, and mouse redirection (KVM) over LAN. This feature is available remotely from the embedded web server as a Java\* applet. This feature is only enabled when the Intel® RMM4 Lite is present. The client system must have a Java Runtime Environment (JRE) version 6.0 or later to run the KVM or media redirection applets.

The BMC supports an embedded KVM application (Remote Console) that can be launched from the embedded web server from a remote console. USB1.1 or USB 2.0 based mouse and keyboard redirection are supported. It is also possible to use the KVM redirection (KVM-r) session concurrently with media redirection (media-r). This feature allows a user to interactively use the keyboard, video, and mouse functions of the remote server as if the user were physically at the managed server. KVM redirection console supports the following keyboard layouts: English, Dutch, French, German, Italian, Russian, and Spanish.

KVM redirection includes a soft keyboard function. The soft keyboard is used to simulate an entire keyboard that is connected to the remote system. The soft keyboard functionality supports the following layouts: English, Dutch, French, German, Italian, Russian, and Spanish.

The KVM redirection feature automatically senses video resolution for best possible screenshot and provides high-performance mouse tracking and synchronization. It allows remote viewing and configuration in pre-boot POST and BIOS setup, once BIOS has initialized video.

Other attributes of this feature include:

- Encryption of the redirected screen, keyboard, and mouse
- Compression of the redirected screen.
- Ability to select a mouse configuration based on the OS type.
- Support for user definable keyboard macros.

KVM redirection feature supports the following resolutions and refresh rates:

- 640x480 at 60 Hz, 72 Hz, 75 Hz, 85 Hz
- 800x600 at 60 Hz, 72 Hz, 75 Hz, 85 Hz
- 1024x768 at 60 Hz, 72 Hz, 75 Hz, 85 Hz
- 1152x864 at 75 Hz
- 1280x800 at 60 Hz
- 1280x1024 at 60 Hz
- 1440x900 at 60 Hz
- 1600x1200 at 60 Hz

#### **10.3.1.1 Availability**

The remote KVM session is available even when the server is powered off (in stand-by mode). No restart of the remote KVM session is required during a server reset or power on/off. A BMC reset – for example, due to a BMC watchdog initiated reset or BMC reset after BMC firmware update – does require the session to be re-established.

KVM sessions persist across system reset, but not across an AC power loss.

#### **10.3.1.2 Security**

The KVM redirection feature supports multiple encryption algorithms, including RC4 and AES. The actual algorithm that is used is negotiated with the client based on the client's capabilities.

#### **10.3.1.3 Usage**

As the server is powered up, the remote KVM session displays the complete BIOS boot process. The user is able to interact with BIOS setup, change and save settings, and enter and interact with option ROM configuration screens.

#### **10.3.1.4 Force-enter BIOS Setup**

KVM redirection can present an option to force-enter BIOS setup. This enables the system to enter BIOS setup while booting, which is often missed by the time the remote console redirects the video.

### **10.3.2 Media Redirection**

The embedded web server provides a Java applet to enable remote media redirection. This may be used in conjunction with the remote KVM feature or as a stand-alone applet.

The media redirection feature is intended to allow system administrators or users to mount a remote IDE or USB CD-ROM, floppy drive, or a USB flash disk as a remote device to the server. Once mounted, the remote device appears to the server just like a local device, allowing system administrators or users to install software (including operating systems), copy files, update BIOS, or boot the server from this device.

The following list describes additional media redirection capabilities and features.

- The operation of remotely mounted devices is independent of the local devices on the server. Both remote and local devices are usable in parallel.
- Either IDE (CD-ROM, floppy) or USB devices can be mounted as a remote device to the server.
- It is possible to boot all supported operating systems from the remotely mounted device and to boot from disk IMAGE (\*.IMG) and CD-ROM or DVD-ROM ISO files. See the tested/supported operating system list for more information.
- Media redirection supports redirection for both a virtual CD device and a virtual floppy/USB device concurrently. The CD device may be either a local CD drive or else an ISO image file; the Floppy/USB device may be either a local Floppy drive, a local USB device, or else a disk image file.

- The media redirection feature supports multiple encryption algorithms, including RC4 and AES. The actual algorithm that is used is negotiated with the client based on the client's capabilities.
- A remote media session is maintained even when the server is powered off (in standby mode). No restart of the remote media session is required during a server reset or power on/off. A BMC reset (for example, due to a BMC reset after BMC FW update) requires the session to be re-established
- The mounted device is visible to (and usable by) managed system's OS and BIOS in both pre-boot and post-boot states.
- The mounted device shows up in the BIOS boot order and it is possible to change the BIOS boot order to boot from this remote device.
- It is possible to install an operating system on a bare metal server (no OS present) using the remotely mounted device. This may also require the use of KVM-r to configure the OS during installation.

USB storage devices appear as floppy disks over media redirection. This allows for the installation of device drivers during OS installation.

If either a virtual IDE or virtual floppy device is remotely attached during system boot, both the virtual IDE and virtual floppy are presented as bootable devices. It is not possible to present only a single-mounted device type to the system BIOS.

#### **10.3.2.1 Availability**

The default inactivity timeout is 30 minutes and is not user-configurable. Media redirection sessions persist across system reset but not across an AC power loss or BMC reset.

#### **10.3.3 Remote Console**

The remote console is the redirected screen, keyboard, and mouse of the remote host system. To use the remote console window of the managed host system, the browser must include a Java\* Runtime Environment (JRE) plug-in. If the browser has no Java support, such as with a small handheld device, the user can maintain the remote host system using the administration forms displayed by the browser.

The remote console window is a Java applet that establishes TCP connections to the BMC. The protocol that is run over these connections is a unique KVM protocol and not HTTP or HTTPS. This protocol uses ports #7578 for KVM, #5120 for CD-ROM media redirection, and #5123 for floppy and USB media redirection. When encryption is enabled, the protocol uses ports #7582 for KVM, #5124 for CD-ROM media redirection, and #5127 for floppy and USB media redirection. The local network environment must permit these connections to be made; that is the firewall and, in case of a private internal network, the Network Address Translation (NAT) settings have to be configured accordingly.

For additional information, reference the *Intel® Remote Management Module 4 and Integrated BMC Web Console User Guide*.

#### **10.3.4 Performance**

The remote display accurately represents the local display. The feature adapts to changes in the video resolution of the local display and continues to work smoothly when the system transitions from graphics to text or vice versa. The responsiveness may be slightly delayed depending on the bandwidth and latency of the network.

Enabling KVM and/or media encryption does degrade performance. Enabling video compression provides the fastest response while disabling compression provides better video quality. For the best possible KVM performance, a 2 Mbps link or higher is recommended. The redirection of KVM over IP is performed in parallel with the local KVM without affecting the local KVM operation.

## Appendix A. Integration and Usage Tips

This section provides a list of useful information that is unique to the Intel® Server System R1000WF product family and should be kept in mind while configuring your server system.

- Intel strongly recommends that system integrators and system service personnel refer to the *Intel® Server System R1000WF Product Family System Integration and Service Guide* for complete system assembly and component installation and removal instructions.
- The process to install and remove processors has changed from all previous generation Intel® server systems. Before attempting to install or remove a processor for the first time, refer to the *Intel® Server System R1000WF Product Family System Integration and Service Guide* for complete processor installation and removal instructions.
- When adding or removing components or peripherals, power cords must be disconnected from the server. With power applied to the server, standby voltages are still present even though the server board is powered off.
- This 1U server system family supports the 1st and 2nd Intel® Xeon® processor Scalable family with a thermal design power (TDP) of up to and including 165 Watts. Previous generations of the Intel® Xeon® processors are not supported.
- Processors must be installed in order. CPU 1 must be populated for the server board to operate.
- To support proper airflow and system thermals when the system is operational, both processor heat sinks must be installed, regardless of whether the system is configured with two processors or not.
- To support proper airflow and system thermals when the system is operational, all 1U system configurations must have specific DIMM slots populated with a DIMM or supplied DIMM blank. See Section 4.1 for complete system thermal configuration requirements.
- The riser card slots are specifically designed to support riser cards only. Attempting to install a PCIe\* add-in card directly into a riser card slot on the server board may damage the server board, the add-in card, or both.
- This server board only supports DDR4 ECC RDIMM – Registered (Buffered) DIMMS and DDR4 ECC LRDIMM – Load Reduced DIMMs.
- For the best performance, the number of DDR4 DIMMs installed should be balanced across both processor sockets and memory channels.
- On the back edge of the server board are eight diagnostic LEDs that display a sequence of amber POST codes during the boot process. If the server board hangs during POST, the LEDs display the last POST event run before the hang.
- The system status LED is set to solid amber for all fatal errors that are detected during processor initialization. A solid amber system status LED indicates that an unrecoverable system failure condition has occurred.
- RAID partitions created using either embedded software RAID option, Intel® VROC (SATA RAID) or Intel® Embedded Server RAID Technology 2, cannot span across the two embedded SATA controllers. Only drives attached to a common SATA controller can be included in a RAID partition.
- The FRUSDR utility must be run as part of the initial platform integration process before it is deployed into a live operating environment. Once the initial FRU and SDR data is loaded on to the system, all subsequent system configuration changes automatically update SDR data using the BMC auto configuration feature, without having to run the FRUSDR utility again. However, to ensure the latest sensor data is installed, the SDR data should be updated to the latest available as part of a planned system software update.
- Make sure the latest system software is loaded on the server. This includes system BIOS, BMC firmware, Intel® ME firmware and FRUSDR. The latest system software can be downloaded from <http://downloadcenter.intel.com>.



## Appendix B. POST Code Diagnostic LED Decoder

As an aid in troubleshooting a system hang that occurs during a system POST process, the server board includes a bank of eight POST code diagnostic LEDs on the back edge of the server board.

During the system boot process, Memory Reference Code (MRC) and system BIOS execute a number of memory initialization and platform configuration processes, each of which is assigned a hex POST code number.

As each routine is started, the given POST code number is displayed to the POST code diagnostic LEDs on the back edge of the server board.

During a POST system hang, the displayed POST code can be used to identify the last POST routine that was run prior to the error occurring, helping to isolate the possible cause of the hang condition.

Each POST code is represented by eight LEDs, four green and four amber. The POST codes are divided into two nibbles, an upper nibble and a lower nibble. The upper nibble bits are represented by amber diagnostic LEDs and the lower nibble bits are represented by green diagnostics. If the bit is set in the upper and lower nibbles, the corresponding LED is lit. If the bit is clear, the corresponding LED is off. For each set of nibble bits, LED 0 represents the least significant bit (LSB) and LED 3 represents the most significant bit (MSB).



Figure 68. Onboard POST diagnostic LEDs

**Note:** Diagnostic LEDs are best read and decoded when viewing the LEDs from the back of the system.

In the following example, the BIOS sends a value of  $AC$  to the diagnostic LED decoder. The LEDs are decoded as shown in Table 53, where the upper nibble bits represented by the amber LEDs equal  $1010_b$  or  $A_h$  and the lower nibble bits represented by the green LEDs equal  $1100_b$  or  $C_h$ . The two are concatenated as  $AC_h$ .

Table 53. POST progress code LED example

Upper Nibble						Lower Nibble					
LED 3 (MSB)	LED 2	LED 1	LED 0 (LSB)	Binary Code	Hex Code	LED 3 (MSB)	LED 2	LED 1	LED 0 (LSB)	Binary Code	Hex Code
ON	off	ON	off	1010	A	ON	ON	off	off	1100	C

## B.1. Early POST Memory Initialization MRC Diagnostic Codes

Memory initialization at the beginning of POST includes multiple functions: discovery, channel training, validation that the DIMM population is acceptable and functional, initialization of the IMC and other hardware settings, and initialization of applicable RAS configurations.

The MRC progress codes are displayed to the diagnostic LEDs that show the execution point in the MRC operational path at each step.

**Table 54. MRC progress codes**

Post Code (Hex)	Upper Nibble				Lower Nibble				Description
	8h	4h	2h	1h	8h	4h	2h	1h	
<b>B0</b>	1	0	1	1	0	0	0	0	Detect DIMM population
<b>B1</b>	1	0	1	1	0	0	0	1	Set DDR4 frequency
<b>B2</b>	1	0	1	1	0	0	1	0	Gather remaining SPD data
<b>B3</b>	1	0	1	1	0	0	1	1	Program registers on the memory controller level
<b>B4</b>	1	0	1	1	0	1	0	0	Evaluate RAS modes and save rank information
<b>B5</b>	1	0	1	1	0	1	0	1	Program registers on the channel level
<b>B6</b>	1	0	1	1	0	1	1	0	Perform the JEDEC defined initialization sequence
<b>B7</b>	1	0	1	1	0	1	1	1	Train DDR4 ranks
<b>01</b>	0	0	0	0	0	0	0	1	Train DDR4 ranks
<b>02</b>	0	0	0	0	0	0	1	0	Train DDR4 ranks – Read DQ/DQS training
<b>03</b>	0	0	0	0	0	0	1	1	Train DDR4 ranks – Receive enable training
<b>04</b>	0	0	0	0	0	1	0	0	Train DDR4 ranks – Write leveling training
<b>05</b>	0	0	0	0	0	1	0	1	Train DDR4 ranks – DDR channel training done
<b>B8</b>	1	0	1	1	1	0	0	0	Initialize CLTT/OLTT
<b>B9</b>	1	0	1	1	1	0	0	1	Hardware memory test and initialization
<b>BA</b>	1	0	1	1	1	0	1	0	Execute software memory init initialization
<b>BB</b>	1	0	1	1	1	0	1	1	Program memory map and interleaving
<b>BC</b>	1	0	1	1	1	1	0	0	Program RAS configuration
<b>BF</b>	1	0	1	1	1	1	1	1	MRC is done

Should a major memory initialization error occur, preventing the system from booting with data integrity, a beep code is generated, the MRC displays a fatal error code on the diagnostic LEDs, and a system halt command is executed. Fatal MRC error halts do not change the state of the system status LED and they do not get logged as SEL events. Table 55 lists all MRC fatal errors that are displayed to the diagnostic LEDs.

---

**Note:** Fatal MRC errors display POST error codes that may be the same as BIOS POST progress codes displayed later in the POST process. The fatal MRC codes can be distinguished from the BIOS POST progress codes by the accompanying memory failure beep code of three long beeps as identified in Table 58.

---

**Table 55. MRC fatal error codes**

Post Code (Hex)	Upper Nibble				Lower Nibble				Description
	8h	4h	2h	1h	8h	4h	2h	1h	
<b>E8</b>	1	1	1	0	1	0	0	0	No usable memory error 01h = No memory was detected from SPD read, or invalid config that causes no operable memory. 02h = Memory DIMMs on all channels of all sockets are disabled due to hardware memtest error. 03h = No memory installed. All channels are disabled.
<b>E9</b>	1	1	1	0	1	0	0	1	Memory is locked by Intel® TXT and is inaccessible
<b>EA</b>	1	1	1	0	1	0	1	0	DDR4 channel training error 01h = Error on read DQ/DQS (Data/Data Strobe) init 02h = Error on Receive Enable 03h = Error on Write Leveling 04h = Error on write DQ/DQS (Data/Data Strobe)
<b>EB</b>	1	1	1	0	1	0	1	1	Memory test failure 01h = Software memtest failure. 02h = Hardware memtest failed.
<b>ED</b>	1	1	1	0	1	1	0	1	DIMM configuration population error 01h = Different DIMM types (RDIMM, LRDIMM) are detected installed in the system. 02h = Violation of DIMM population rules. 03h = The 3rd DIMM slot cannot be populated when QR DIMMs are installed. 04h = UDIMMs are not supported. 05h = Unsupported DIMM Voltage.
<b>EF</b>	1	1	1	0	1	1	1	1	Indicates a CLTT table structure error

## B.1. BIOS POST Progress Codes

Table 56 provides a list of all POST progress codes.

**Table 56. POST progress codes**

Post Code (Hex)	Upper Nibble				Lower Nibble				Description
	8h	4h	2h	1h	8h	4h	2h	1h	
<b>SEC Phase</b>									
01	0	0	0	0	0	0	0	1	First POST code after CPU reset
02	0	0	0	0	0	0	1	0	Microcode load begin
03	0	0	0	0	0	0	1	1	CRAM initialization begin
04	0	0	0	0	0	1	0	0	PEI Cache When Disabled
05	0	0	0	0	0	1	0	1	SEC Core At Power On Begin.
06	0	0	0	0	0	1	1	0	Early CPU initialization during SEC Phase.
<b>KTI RC (Fully leverage without platform change)</b>									
A1	1	0	1	0	0	0	0	1	Collect info such as SBSP, boot mode, reset type, etc.
A3	1	0	1	0	0	0	1	1	Setup minimum path between SBSP and other sockets
A6	1	0	1	0	0	1	1	0	Sync up with PBSPs
A7	1	0	1	0	0	1	1	1	Topology discovery and route calculation
A8	1	0	1	0	1	0	0	0	Program final route
A9	1	0	1	0	1	0	0	1	Program final IO SAD setting
AA	1	0	1	0	1	0	1	0	Protocol layer and other uncore settings
AB	1	0	1	0	1	0	1	1	Transition links to full speed operation
AE	1	0	1	0	1	1	1	0	Coherency settings
AF	1	0	1	0	1	1	1	1	KTI initialization done
<b>PEI Phase</b>									
10	0	0	0	1	0	0	0	0	PEI Core
11	0	0	0	1	0	0	0	1	CPU PEIM
15	0	0	0	1	0	1	0	1	Platform Type Init
19	0	0	0	1	1	0	0	1	Platform PEIM Init
31	0	0	1	1	0	0	0	1	Memory Installed
32	0	0	1	1	0	0	1	0	CPU PEIM (CPU Init)
33	0	0	1	1	0	0	1	1	CPU PEIM (Cache Init)
34	0	0	1	1	0	1	0	0	CPU BSP Select
35	0	0	1	1	0	1	0	1	CPU AP Init
36	0	0	1	1	0	1	1	0	CPU SMM Init
4F	0	1	0	0	1	1	1	1	DXE IPL started
<b>DXE Phase</b>									
60	0	1	1	0	0	0	0	0	DXE Core started
62	0	1	1	0	0	0	1	0	DXE Setup Init
68	0	1	1	0	1	0	0	0	DXE PCI Host Bridge Init
69	0	1	1	0	1	0	0	1	DXE NB Init
6A	0	1	1	0	1	0	1	0	DXE NB SMM Init
70	0	1	1	1	0	0	0	0	DXE SB Init
71	0	1	1	1	0	0	0	1	DXE SB SMM Init
72	0	1	1	1	0	0	1	0	DXE SB devices Init
78	0	1	1	1	1	0	0	0	DXE ACPI Init
79	0	1	1	1	1	0	0	1	DXE CSM Init

Post Code (Hex)	Upper Nibble				Lower Nibble				Description
	8h	4h	2h	1h	8h	4h	2h	1h	
7D	0	1	1	1	1	1	0	1	DXE Removable Media Detect
7E	0	1	1	1	1	1	1	0	DXE Removable Media Detected
90	1	0	0	1	0	0	0	0	DXE BDS started
91	1	0	0	1	0	0	0	1	DXE BDS connect drivers
92	1	0	0	1	0	0	1	0	DXE PCI bus begin
93	1	0	0	1	0	0	1	1	DXE PCI Bus HPC Init
94	1	0	0	1	0	1	0	0	DXE PCI Bus enumeration
95	1	0	0	1	0	1	0	1	DXE PCI Bus resource requested
96	1	0	0	1	0	1	1	0	DXE PCI Bus assign resource
97	1	0	0	1	0	1	1	1	DXE CON_OUT connect
98	1	0	0	1	1	0	0	0	DXE CON_IN connect
99	1	0	0	1	1	0	0	1	DXE SIO Init
9A	1	0	0	1	1	0	1	0	DXE USB start
9B	1	0	0	1	1	0	1	1	DXE USB reset
9C	1	0	0	1	1	1	0	0	DXE USB detect
9D	1	0	0	1	1	1	0	1	DXE USB enable
A1	1	0	1	0	0	0	0	1	DXE IDE begin
A2	1	0	1	0	0	0	1	0	DXE IDE reset
A3	1	0	1	0	0	0	1	1	DXE IDE detect
A4	1	0	1	0	0	1	0	0	DXE IDE enable
A5	1	0	1	0	0	1	0	1	DXE SCSI begin
A6	1	0	1	0	0	1	1	0	DXE SCSI reset
A7	1	0	1	0	0	1	1	1	DXE SCSI detect
A8	1	0	1	0	1	0	0	0	DXE SCSI enable
AB	1	0	1	0	1	0	1	1	DXE SETUP start
AC	1	0	1	0	1	1	0	0	DXE SETUP input wait
AD	1	0	1	0	1	1	0	1	DXE Ready to Boot
AE	1	0	1	0	1	1	1	0	DXE Legacy Boot
AF	1	0	1	0	1	1	1	1	DXE Exit Boot Services
B0	1	0	1	1	0	0	0	0	RT Set Virtual Address Map Begin
B1	1	0	1	1	0	0	0	1	RT Set Virtual Address Map End
B2	1	0	1	1	0	0	1	0	DXE Legacy Option ROM init
B3	1	0	1	1	0	0	1	1	DXE Reset system
B4	1	0	1	1	0	1	0	0	DXE USB Hot plug
B5	1	0	1	1	0	1	0	1	DXE PCI BUS Hot plug
B8	1	0	1	1	1	0	0	0	PWRBTN Shutdown
B9	1	0	1	1	1	0	0	1	SLEEP Shutdown
C0	1	1	0	0	0	0	0	0	End of DXE
C7	1	1	0	0	0	1	1	1	DXE ACPI Enable
0	0	0	0	0	0	0	0	0	Clear POST Code

Post Code (Hex)	Upper Nibble				Lower Nibble				Description
	8h	4h	2h	1h	8h	4h	2h	1h	
<b>S3 Resume</b>									
E0	1	1	1	0	0	0	0	0	S3 Resume PEIM (S3 started)
E1	1	1	1	0	0	0	0	1	S3 Resume PEIM (S3 boot script)
E2	1	1	1	0	0	0	1	0	S3 Resume PEIM (S3 Video Repost)
E3	1	1	1	0	0	0	1	1	S3 Resume PEIM (S3 OS wake)
<b>BIOS Recovery</b>									
F0	1	1	1	1	0	0	0	0	PEIM which detected forced Recovery condition
F1	1	1	1	1	0	0	0	1	PEIM which detected User Recovery condition
F2	1	1	1	1	0	0	1	0	Recovery PEIM (Recovery started)
F3	1	1	1	1	0	0	1	1	Recovery PEIM (Capsule found)
F4	1	1	1	1	0	1	0	0	Recovery PEIM (Capsule loaded)

## Appendix C. POST Code Errors

Most error conditions encountered during POST are reported using POST error codes. These codes represent specific failures, warnings, or information. POST error codes may be displayed in the error manager display screen and are always logged to the System Event Log (SEL). Logged events are available to system management applications, including remote and Out of Band (OOB) management.

There are exception cases in early initialization where system resources are not adequately initialized for handling POST Error Code reporting. These cases are primarily fatal error conditions resulting from initialization of processors and memory, and they are handled by a diagnostic LED display with a system halt.

Table 57 lists the supported POST error codes. Each error code is assigned an error type, which determines the action the BIOS takes when the error is encountered. Error types include minor, major, and fatal. The BIOS action for each is defined as follows:

- **Minor:** An error message may be displayed to the screen or to the BIOS setup error manager and the POST error code is logged to the SEL. The system continues booting in a degraded state. The user may want to replace the erroneous unit. The “POST Error Pause” option setting in the BIOS setup does not have any effect on this error.
- **Major:** An error message is displayed to the error manager screen and an error is logged to the SEL. If the BIOS setup option “Post Error Pause” is enabled, operator intervention is required to continue booting the system. If the BIOS setup option “POST Error Pause” is disabled, the system continues to boot.

---

**Note:** For 0048 “Password check failed”, the system halts and then, after the next reset/reboot, displays the error code on the error manager screen.

---

- **Fatal:** If the system cannot boot, POST halts and display the following message:

```
Unrecoverable fatal error found. System will not boot until the error is
resolved
Press <F2> to enter setup
```

When the <F2> key on the keyboard is pressed, the error message is displayed on the error manager screen and an error is logged to the system event log (SEL) with the POST error code. The system cannot boot unless the error is resolved. The faulty component must be replaced. The “POST Error Pause” option setting in the BIOS setup does not have any effect on this error.

---

**Note:** The POST error codes in the following table are common to all current generation Intel® server platforms. Features present on a given server board/system determine which of the listed error codes are supported.

---

**Table 57. POST error messages and handling**

<b>Error Code</b>	<b>Error Message</b>	<b>Action message</b>	<b>Response</b>
<b>0012</b>	System RTC date/time not set		Major
<b>0048</b>	Password check failed	Please put right password.	Major
<b>0140</b>	PCI component encountered a PERR error		Major
<b>0141</b>	PCI resource conflict		Major
<b>0146</b>	PCI out of resources error	Please enable Memory Mapped I/O above 4 GB item at SETUP to use 64-bit MMIO.	Major
<b>0191</b>	Processor core/thread count mismatch detected	Please use identical CPU type.	Fatal
<b>0192</b>	Processor cache size mismatch detected	Please use identical CPU type.	Fatal
<b>0194</b>	Processor family mismatch detected	Please use identical CPU type.	Fatal
<b>0195</b>	Processor Intel(R) UPI link frequencies unable to synchronize		Fatal
<b>0196</b>	Processor model mismatch detected	Please use identical CPU type.	Fatal
<b>0197</b>	Processor frequencies unable to synchronize	Please use identical CPU type.	Fatal
<b>5220</b>	BIOS Settings reset to default settings		Major
<b>5221</b>	Passwords cleared by jumper		Major
<b>5224</b>	Password clear jumper is Set	Recommend to remind user to install BIOS password as BIOS admin password is the master keys for several BIOS security features.	Major
<b>8130</b>	Processor 01 disabled		Major
<b>8131</b>	Processor 02 disabled		Major
<b>8160</b>	Processor 01 unable to apply microcode update		Major
<b>8161</b>	Processor 02 unable to apply microcode update		Major
<b>8170</b>	Processor 01 failed Self-Test (BIST)		Major
<b>8171</b>	Processor 02 failed Self-Test (BIST)		Major
<b>8180</b>	Processor 01 microcode update not found		Minor
<b>8181</b>	Processor 02 microcode update not found		Minor
<b>8190</b>	Watchdog timer failed on last boot.		Major
<b>8198</b>	OS boot watchdog timer failure.		Major
<b>8300</b>	Baseboard Management Controller failed self-test.		Major
<b>8305</b>	Hot Swap Controller failure		Major
<b>83A0</b>	Management Engine (ME) failed self-test.		Major
<b>83A1</b>	Management Engine (ME) Failed to respond.		Major
<b>84F2</b>	Baseboard management controller failed to respond		Major
<b>84F3</b>	Baseboard Management Controller in Update Mode.		Major
<b>84F4</b>	Baseboard Management Controller Sensor Data Record empty.	Please update right SDR.	Major
<b>84FF</b>	System Event Log full	Please clear SEL through EWS or SELVIEW utility.	Minor



## Intel® Server System R1000WF Product Family Technical Product Specification

<b>85FC</b>	Memory component could not be configured in the selected RAS mode		Major
<b>8501</b>	Memory Population Error	Please plug DIMM at right population.	Major
<b>8520</b>	Memory failed test/initialization CPU1_DIMM_A1	Please remove the disabled DIMM.	Major
<b>8521</b>	Memory failed test/initialization CPU1_DIMM_A2	Please remove the disabled DIMM.	Major
<b>8522</b>	Memory failed test/initialization CPU1_DIMM_A3	Please remove the disabled DIMM.	Major
<b>8523</b>	Memory failed test/initialization CPU1_DIMM_B1	Please remove the disabled DIMM.	Major
<b>8524</b>	Memory failed test/initialization CPU1_DIMM_B2	Please remove the disabled DIMM.	Major
<b>8525</b>	Memory failed test/initialization CPU1_DIMM_B3	Please remove the disabled DIMM.	Major
<b>8526</b>	Memory failed test/initialization CPU1_DIMM_C1	Please remove the disabled DIMM.	Major
<b>8527</b>	Memory failed test/initialization CPU1_DIMM_C2	Please remove the disabled DIMM.	Major
<b>8528</b>	Memory failed test/initialization CPU1_DIMM_C3	Please remove the disabled DIMM.	Major
<b>8529</b>	Memory failed test/initialization CPU1_DIMM_D1	Please remove the disabled DIMM.	Major
<b>852A</b>	Memory failed test/initialization CPU1_DIMM_D2	Please remove the disabled DIMM.	Major
<b>852B</b>	Memory failed test/initialization CPU1_DIMM_D3	Please remove the disabled DIMM.	Major
<b>852C</b>	Memory failed test/initialization CPU1_DIMM_E1	Please remove the disabled DIMM.	Major
<b>852D</b>	Memory failed test/initialization CPU1_DIMM_E2	Please remove the disabled DIMM.	Major
<b>852E</b>	Memory failed test/initialization CPU1_DIMM_E3	Please remove the disabled DIMM.	Major
<b>852F</b>	Memory failed test/initialization CPU1_DIMM_F1	Please remove the disabled DIMM.	Major
<b>8530</b>	Memory failed test/initialization CPU1_DIMM_F2	Please remove the disabled DIMM.	Major
<b>8531</b>	Memory failed test/initialization CPU1_DIMM_F3	Please remove the disabled DIMM.	Major
<b>8532</b>	Memory failed test/initialization CPU1_DIMM_G1	Please remove the disabled DIMM.	Major
<b>8533</b>	Memory failed test/initialization CPU1_DIMM_G2	Please remove the disabled DIMM.	Major
<b>8534</b>	Memory failed test/initialization CPU1_DIMM_G3	Please remove the disabled DIMM.	Major
<b>8535</b>	Memory failed test/initialization CPU1_DIMM_H1	Please remove the disabled DIMM.	Major
<b>8536</b>	Memory failed test/initialization CPU1_DIMM_H2	Please remove the disabled DIMM.	Major
<b>8537</b>	Memory failed test/initialization CPU1_DIMM_H3	Please remove the disabled DIMM.	Major
<b>8538</b>	Memory failed test/initialization CPU2_DIMM_A1	Please remove the disabled DIMM.	Major
<b>8539</b>	Memory failed test/initialization CPU2_DIMM_A2	Please remove the disabled DIMM.	Major
<b>853A</b>	Memory failed test/initialization CPU2_DIMM_A3	Please remove the disabled DIMM.	Major
<b>853B</b>	Memory failed test/initialization CPU2_DIMM_B1	Please remove the disabled DIMM.	Major
<b>853C</b>	Memory failed test/initialization CPU2_DIMM_B2	Please remove the disabled DIMM.	Major
<b>853D</b>	Memory failed test/initialization CPU2_DIMM_B3	Please remove the disabled DIMM.	Major
<b>853E</b>	Memory failed test/initialization CPU2_DIMM_C1	Please remove the disabled DIMM.	Major
<b>853F (Go to 85C0)</b>	Memory failed test/initialization CPU2_DIMM_C2	Please remove the disabled DIMM.	Major
<b>8540</b>	Memory disabled.CPU1_DIMM_A1	Please remove the disabled DIMM.	Major
<b>8541</b>	Memory disabled.CPU1_DIMM_A2	Please remove the disabled DIMM.	Major
<b>8542</b>	Memory disabled.CPU1_DIMM_A3	Please remove the disabled DIMM.	Major
<b>8543</b>	Memory disabled.CPU1_DIMM_B1	Please remove the disabled DIMM.	Major
<b>8544</b>	Memory disabled.CPU1_DIMM_B2	Please remove the disabled DIMM.	Major

## Intel® Server System R1000WF Product Family Technical Product Specification

<b>8545</b>	Memory disabled.CPU1_DIMM_B3	Please remove the disabled DIMM.	Major
<b>8546</b>	Memory disabled.CPU1_DIMM_C1	Please remove the disabled DIMM.	Major
<b>8547</b>	Memory disabled.CPU1_DIMM_C2	Please remove the disabled DIMM.	Major
<b>8548</b>	Memory disabled.CPU1_DIMM_C3	Please remove the disabled DIMM.	Major
<b>8549</b>	Memory disabled.CPU1_DIMM_D1	Please remove the disabled DIMM.	Major
<b>854A</b>	Memory disabled.CPU1_DIMM_D2	Please remove the disabled DIMM.	Major
<b>854B</b>	Memory disabled.CPU1_DIMM_D3	Please remove the disabled DIMM.	Major
<b>854C</b>	Memory disabled.CPU1_DIMM_E1	Please remove the disabled DIMM.	Major
<b>854D</b>	Memory disabled.CPU1_DIMM_E2	Please remove the disabled DIMM.	Major
<b>854E</b>	Memory disabled.CPU1_DIMM_E3	Please remove the disabled DIMM.	Major
<b>854F</b>	Memory disabled.CPU1_DIMM_F1	Please remove the disabled DIMM.	Major
<b>8550</b>	Memory disabled.CPU1_DIMM_F2	Please remove the disabled DIMM.	Major
<b>8551</b>	Memory disabled.CPU1_DIMM_F3	Please remove the disabled DIMM.	Major
<b>8552</b>	Memory disabled.CPU1_DIMM_G1	Please remove the disabled DIMM.	Major
<b>8553</b>	Memory disabled.CPU1_DIMM_G2	Please remove the disabled DIMM.	Major
<b>8554</b>	Memory disabled.CPU1_DIMM_G3	Please remove the disabled DIMM.	Major
<b>8555</b>	Memory disabled.CPU1_DIMM_H1	Please remove the disabled DIMM.	Major
<b>8556</b>	Memory disabled.CPU1_DIMM_H2	Please remove the disabled DIMM.	Major
<b>8557</b>	Memory disabled.CPU1_DIMM_H3	Please remove the disabled DIMM.	Major
<b>8558</b>	Memory disabled.CPU2_DIMM_A1	Please remove the disabled DIMM.	Major
<b>8559</b>	Memory disabled.CPU2_DIMM_A2	Please remove the disabled DIMM.	Major
<b>855A</b>	Memory disabled.CPU2_DIMM_A3	Please remove the disabled DIMM.	Major
<b>855B</b>	Memory disabled.CPU2_DIMM_B1	Please remove the disabled DIMM.	Major
<b>855C</b>	Memory disabled.CPU2_DIMM_B2	Please remove the disabled DIMM.	Major
<b>855D</b>	Memory disabled.CPU2_DIMM_B3	Please remove the disabled DIMM.	Major
<b>855E</b>	Memory disabled.CPU2_DIMM_C1	Please remove the disabled DIMM.	Major
<b>855F (Go to 85D0)</b>	Memory disabled.CPU2_DIMM_C2	Please remove the disabled DIMM.	Major
<b>8560</b>	Memory encountered a Serial Presence Detection (SPD) failure.CPU1_DIMM_A1		Major
<b>8561</b>	Memory encountered a Serial Presence Detection (SPD) failure.CPU1_DIMM_A2		Major
<b>8562</b>	Memory encountered a Serial Presence Detection (SPD) failure.CPU1_DIMM_A3		Major
<b>8563</b>	Memory encountered a Serial Presence Detection (SPD) failure.CPU1_DIMM_B1		Major
<b>8564</b>	Memory encountered a Serial Presence Detection (SPD) failure.CPU1_DIMM_B2		Major
<b>8565</b>	Memory encountered a Serial Presence Detection (SPD) failure.CPU1_DIMM_B3		Major
<b>8566</b>	Memory encountered a Serial Presence Detection (SPD) failure.CPU1_DIMM_C1		Major
<b>8567</b>	Memory encountered a Serial Presence Detection (SPD) failure.CPU1_DIMM_C2		Major

<b>8568</b>	Memory encountered a Serial Presence Detection (SPD) failure.CPU1_DIMM_C3		Major
<b>8569</b>	Memory encountered a Serial Presence Detection (SPD) failure.CPU1_DIMM_D1		Major
<b>856A</b>	Memory encountered a Serial Presence Detection (SPD) failure.CPU1_DIMM_D2		Major
<b>856B</b>	Memory encountered a Serial Presence Detection (SPD) failure.CPU1_DIMM_D3		Major
<b>856C</b>	Memory encountered a Serial Presence Detection (SPD) failure.CPU1_DIMM_E1		Major
<b>856D</b>	Memory encountered a Serial Presence Detection (SPD) failure.CPU1_DIMM_E2		Major
<b>856E</b>	Memory encountered a Serial Presence Detection (SPD) failure.CPU1_DIMM_E3		Major
<b>856F</b>	Memory encountered a Serial Presence Detection (SPD) failure.CPU1_DIMM_F1		Major
<b>8570</b>	Memory encountered a Serial Presence Detection (SPD) failure.CPU1_DIMM_F2		Major
<b>8571</b>	Memory encountered a Serial Presence Detection (SPD) failure.CPU1_DIMM_F3		Major
<b>8572</b>	Memory encountered a Serial Presence Detection (SPD) failure.CPU1_DIMM_G1		Major
<b>8573</b>	Memory encountered a Serial Presence Detection (SPD) failure.CPU1_DIMM_G2		Major
<b>8574</b>	Memory encountered a Serial Presence Detection (SPD) failure.CPU1_DIMM_G3		Major
<b>8575</b>	Memory encountered a Serial Presence Detection (SPD) failure.CPU1_DIMM_H1		Major
<b>8576</b>	Memory encountered a Serial Presence Detection (SPD) failure.CPU1_DIMM_H2		Major
<b>8577</b>	Memory encountered a Serial Presence Detection (SPD) failure.CPU1_DIMM_H3		Major
<b>8578</b>	Memory encountered a Serial Presence Detection (SPD) failure.CPU2_DIMM_A1		Major
<b>8579</b>	Memory encountered a Serial Presence Detection (SPD) failure.CPU2_DIMM_A2		Major
<b>857A</b>	Memory encountered a Serial Presence Detection (SPD) failure.CPU2_DIMM_A3		Major
<b>857B</b>	Memory encountered a Serial Presence Detection (SPD) failure.CPU2_DIMM_B1		Major
<b>857C</b>	Memory encountered a Serial Presence Detection (SPD) failure.CPU2_DIMM_B2		Major
<b>857D</b>	Memory encountered a Serial Presence Detection (SPD) failure.CPU2_DIMM_B3		Major
<b>857E</b>	Memory encountered a Serial Presence Detection (SPD) failure.CPU2_DIMM_C1		Major
<b>857F (Go to 85E0)</b>	Memory encountered a Serial Presence Detection (SPD) failure.CPU2_DIMM_C2		Major
<b>85C0</b>	Memory failed test/initialization CPU2_DIMM_C3	Please remove the disabled DIMM.	Major
<b>85C1</b>	Memory failed test/initialization CPU2_DIMM_D1	Please remove the disabled DIMM.	Major
<b>85C2</b>	Memory failed test/initialization CPU2_DIMM_D2	Please remove the disabled DIMM.	Major
<b>85C3</b>	Memory failed test/initialization CPU2_DIMM_D3	Please remove the disabled DIMM.	Major

## Intel® Server System R1000WF Product Family Technical Product Specification

<b>85C4</b>	Memory failed test/initialization CPU2_DIMM_E1	Please remove the disabled DIMM.	Major
<b>85C5</b>	Memory failed test/initialization CPU2_DIMM_E2	Please remove the disabled DIMM.	Major
<b>85C6</b>	Memory failed test/initialization CPU2_DIMM_E3	Please remove the disabled DIMM.	Major
<b>85C7</b>	Memory failed test/initialization CPU2_DIMM_F1	Please remove the disabled DIMM.	Major
<b>85C8</b>	Memory failed test/initialization CPU2_DIMM_F2	Please remove the disabled DIMM.	Major
<b>85C9</b>	Memory failed test/initialization CPU2_DIMM_F3	Please remove the disabled DIMM.	Major
<b>85CA</b>	Memory failed test/initialization CPU2_DIMM_G1	Please remove the disabled DIMM.	Major
<b>85CB</b>	Memory failed test/initialization CPU2_DIMM_G2	Please remove the disabled DIMM.	Major
<b>85CC</b>	Memory failed test/initialization CPU2_DIMM_G3	Please remove the disabled DIMM.	Major
<b>85CD</b>	Memory failed test/initialization CPU2_DIMM_H1	Please remove the disabled DIMM.	Major
<b>85CE</b>	Memory failed test/initialization CPU2_DIMM_H2	Please remove the disabled DIMM.	Major
<b>85CF</b>	Memory failed test/initialization CPU2_DIMM_H3	Please remove the disabled DIMM.	Major
<b>85D0</b>	Memory disabled.CPU2_DIMM_C3	Please remove the disabled DIMM.	Major
<b>85D1</b>	Memory disabled.CPU2_DIMM_D1	Please remove the disabled DIMM.	Major
<b>85D2</b>	Memory disabled.CPU2_DIMM_D2	Please remove the disabled DIMM.	Major
<b>85D3</b>	Memory disabled.CPU2_DIMM_D3	Please remove the disabled DIMM.	Major
<b>85D4</b>	Memory disabled.CPU2_DIMM_E1	Please remove the disabled DIMM.	Major
<b>85D5</b>	Memory disabled.CPU2_DIMM_E2	Please remove the disabled DIMM.	Major
<b>85D6</b>	Memory disabled.CPU2_DIMM_E3	Please remove the disabled DIMM.	Major
<b>85D7</b>	Memory disabled.CPU2_DIMM_F1	Please remove the disabled DIMM.	Major
<b>85D8</b>	Memory disabled.CPU2_DIMM_F2	Please remove the disabled DIMM.	Major
<b>85D9</b>	Memory disabled.CPU2_DIMM_F3	Please remove the disabled DIMM.	Major
<b>85DA</b>	Memory disabled.CPU2_DIMM_G1	Please remove the disabled DIMM.	Major
<b>85DB</b>	Memory disabled.CPU2_DIMM_G2	Please remove the disabled DIMM.	Major
<b>85DC</b>	Memory disabled.CPU2_DIMM_G3	Please remove the disabled DIMM.	Major
<b>85DD</b>	Memory disabled.CPU2_DIMM_H1	Please remove the disabled DIMM.	Major
<b>85DE</b>	Memory disabled.CPU2_DIMM_H2	Please remove the disabled DIMM.	Major
<b>85DF</b>	Memory disabled.CPU2_DIMM_H3	Please remove the disabled DIMM.	Major
<b>85E0</b>	Memory encountered a Serial Presence Detection (SPD) failure.CPU2_DIMM_C3		Major
<b>85E1</b>	Memory encountered a Serial Presence Detection (SPD) failure. CPU2_DIMM_D1		Major
<b>85E2</b>	Memory encountered a Serial Presence Detection (SPD) failure.CPU2_DIMM_D2		Major
<b>85E3</b>	Memory encountered a Serial Presence Detection (SPD) failure.CPU2_DIMM_D3		Major
<b>85E4</b>	Memory encountered a Serial Presence Detection (SPD) failure.CPU2_DIMM_E1		Major
<b>85E5</b>	Memory encountered a Serial Presence Detection (SPD) failure.CPU2_DIMM_E2		Major
<b>85E6</b>	Memory encountered a Serial Presence Detection (SPD) failure.CPU2_DIMM_E3		Major
<b>85E7</b>	Memory encountered a Serial Presence Detection (SPD) failure.CPU2_DIMM_F1		Major

<b>85E8</b>	Memory encountered a Serial Presence Detection (SPD) failure. CPU2_DIMM_F2		Major
<b>85E9</b>	Memory encountered a Serial Presence Detection (SPD) failure. CPU2_DIMM_F3		Major
<b>85EA</b>	Memory encountered a Serial Presence Detection (SPD) failure. CPU2_DIMM_G1		Major
<b>85EB</b>	Memory encountered a Serial Presence Detection (SPD) failure. CPU2_DIMM_G2		Major
<b>85EC</b>	Memory encountered a Serial Presence Detection (SPD) failure. CPU2_DIMM_G3		Major
<b>85ED</b>	Memory encountered a Serial Presence Detection (SPD) failure. CPU2_DIMM_H1		Major
<b>85EE</b>	Memory encountered a Serial Presence Detection (SPD) failure. CPU2_DIMM_H2		Major
<b>85EF</b>	Memory encountered a Serial Presence Detection (SPD) failure. CPU2_DIMM_H3		Major
<b>8604</b>	POST Reclaim of non-critical NVRAM variables		Minor
<b>8605</b>	BIOS Settings are corrupted		Major
<b>8606</b>	NVRAM variable space was corrupted and has been reinitialized		Major
<b>8607</b>	Recovery boot has been initiated. <b>Note:</b> The Primary BIOS image may be corrupted or the system may hang during POST. A BIOS update is required.		Fatal
<b>A100</b>	BIOS ACM Error		Major
<b>A421</b>	PCI component encountered a SERR error		Fatal
<b>A5A0</b>	PCI Express component encountered a PERR error		Minor
<b>A5A1</b>	PCI Express component encountered an SERR error		Fatal
<b>A6A0</b>	DXE Boot Services driver: Not enough memory available to shadow a Legacy Option ROM.	Please disable OpRom at SETUP to save runtime memory.	Minor

## C.1. POST Error Beep Codes

Table 58 lists the POST error beep codes. Prior to system video initialization, the BIOS uses these beep codes to inform users on error conditions. The beep code is followed by a user-visible code on the POST progress LEDs.

**Table 58. POST error beep codes**

Beeps	Error Message	POST Progress Code	Description
1 short	USB device action	N/A	Short beep sounded whenever USB device is discovered in POST, or inserted or removed during runtime.
1 long	Intel® TXT security violation	AE, AF	System halted because Intel® Trusted Execution Technology detected a potential violation of system security.
3 short	Memory error	Multiple	System halted because a fatal error related to the memory was detected.
3 long and 1 short	CPU mismatch error	E5, E6	System halted because a fatal error related to the CPU family/core/cache mismatch was detected.
2 short	BIOS recovery started	N/A	BIOS recovery boot has been initiated.
4 short	BIOS recovery failed	N/A	BIOS recovery has failed. This typically happens so quickly after recovery is initiated that it sounds like a 2–4 beep code.

The Integrated BMC may generate beep codes upon detection of failure conditions. Beep codes are sounded each time the problem is discovered, such as on each power-up attempt, but are not sounded continuously. Codes that are common across all Intel® server boards and systems that use same generation chipset are listed in Table 59. Each digit in the code is represented by a sequence of beeps whose count is equal to the digit.

**Table 59. Integrated BMC beep codes**

Code	Reason for Beep	Associated Sensors
1-5-1-2	VR Watchdog Timer sensor assertion	VR Watchdog Timer
1-5-1-4	The system does not power on or unexpectedly power off and a power supply unit (PSU) is present that is an incompatible model with one or more other PSUs in the system	PS Status
1-5-2-1	No CPUs installed or first CPU socket is empty	CPU Missing Sensor
1-5-2-2	CPU CAT Error (IERR) assertion	CPU ERR2 Timeout Sensor
1-5-2-3	CPU ERR2 timeout assertion	CPU ERR2 Timeout Sensor
1-5-2-4	CPU lcc max Mismatch	CPU lcc max Mismatch Sensor
1-5-2-5	CPU population error	CPU 0 Status Sensor
1-5-4-2	Power fault: DC power is unexpectedly lost (power good dropout).	Power unit – power unit failure offset
1-5-4-4	Power control fault (power good assertion timeout).	Power unit – soft power control failure offset

## Appendix D. System Configuration Table for Thermal Compatibility

This section provides two tables listing system configuration compatibility data based on various supported system operating thermal limits. The first table identifies supported system configurations while the system is in “normal” operating mode, meaning all systems fans are present, online, and operational. The second table identifies supported system configurations while the system is in a “fan fail” mode, meaning one system fan or system fan rotor is no longer online or operational and fan redundancy is lost.

The following notes list support criteria associated with specific configurations identified in the following tables and are identified by a reference number within the table. Listed notes that are not specified within the table reflect support criteria for a similar 2U based system within the Intel® Server Board S2600WF product family, details of which can be found in the *Intel® Server System R2000WF Technical Product Specification*.

### Thermal configuration table notes:

1. The 27°C configuration alone is limited to elevations of 900m or less. Altitudes higher than 900m need to be de-rated to ASHRAE Class 2 levels.
2. To support system fan redundancy, the system must be configured with two power supplies to maintain sufficient cooling. Concurrent system and power supply fan failures are not supported.
3. Processor and memory throttling may occur which may impact system performance. CPU reliability is not impacted.
4. In fan fail mode, Intel® Ethernet Connection X557-T2 and Intel® Ethernet Connection X527-DA2, both dual-port OCP mezzanine cards are only supported in the specified base system model configured with 120W processors and DRx4 memory.
5. Use of the designated PCIe\* slot is limited to add-in cards that have airflow requirements of 100 LFM or less. See add-in card specifications for airflow requirements.
6. For ASHRAE Class 3 and Class 4 support, the following power supply margining is required to meet thermal specifications:
  - a. For dual power supply configurations, the power budget must fit within a single power supply rated load and be installed in a dual configuration, or
  - b. For single power supply configurations, the power budget must be sized with 30% margin to single power supply rated load.
7. PCIe\* SSD AIC FF devices can only be supported in the bottom add-in card slot on Riser Slot #1 and Riser Slot #2.
8. The Intel® RAID Maintenance Free Backup Unit (AXXRMFBUX) can support a case temperature of up to 45°C with the system operating in normal mode and up to 55°C with the system operating in a fan fail mode. The case temperature of Intel® Smart RAID Battery (AXXRSBBUX) can support up to 45°C in both normal and fan fail mode. Excursions over these specifications may result in a reliability impact.
9. LBG cooling is not sufficient at higher ambient temperatures, performance could be limited to reduce preheating.
10. System cooling capability testing was carried out in environmental lab controlled conditions according to ASHRAE standard.
11. Performance depends on data center environmental temperature and relative humidity levels controls provided by end user.
12. It is the responsibility of the system integrator to both consider the thermal configuration matrix and power budget tool documents in order to arrange end use configuration.
13. M.2 drives may see performance impact under heavy workload.
14. Light workload is assuming 70% write, 30% read, 100% Random, 100% access, 8kb transfer rate, and IO "delay" of 8.
15. See TPS for thermal limitations.

- 17. PSU Unit 2 supported up to max CPU TDP of 150 W.
- 17. PSU Unit 2 supported up to max CPU TDP of 125 W.
- 18. PSU Unit 2 supported up to max CPU TDP of 105 W.
- 19. PSU Unit 2 supported up to max CPU TDP of 85 W.
- 20. Intel NVMe\* drives were used for thermal testing.
- 21. During fan fail mode CPU throttling might occur due power limiting feature for PSU 2.
- 22. PSU 2 supported up to a max CPU TDP of 135 W (Applies for Fabric SKU only)
- 23. PSU 2 supported up to max CPU TDP of 113 W (Applies for Fabric SKU only).
- 24. Sensor dependent power limiting feature might be triggered for the following components during fan fail conditions and thermal excursions: OCP, PCH, LAN chip, BMC, PSU modules, SAS module, Risers, IFT carriers.

For both tables, a bullet (●) indicates full support without limitation. A cell with a number indicates conditional support; refer to the notes above. A blank cell indicates that the configuration is not supported.

**Table 60. Thermal configuration tables for system in “normal” operating mode for R1304 HDD WF and R1208 HDD WF**

<b>Thermal Config Matrix</b> Normal operating mode "●"= Full support without limitation; "4,5"(Cell with number) = Conditional support with limitation (See notes at beginning of section) Blank Cell = Not supported		R1304 HDD WF								R1208 HDD WF								
		Classifications				A1	A2	A3	A4	Classifications				A1	A2	A3	A4	
ASHRAE (See note 1)	Max Ambient	15°C	20°C	25°C	27°C (1)	32°C	35°C	40°C	45°C	15°C	20°C	25°C	27°C (1)	32°C	35°C	40°C	45°C	
	Altitude	900	900	900	900	900	900	900	900	900	900	900	900	900	900	900	900	
	PS (See note 6)	1300 W AC	●	●	●	●	17	17	19	20	●	●	●	●	18	18	19	20
1100W AC		●	●	●	●	●	●	●	●	●	●	●	●	●	●	●	●	
750W AC		●	17,24	17,24	17,24	19,24	19,24	20,25	21	●	17,24	17,24	17,24	19,24	19,24	20	21	
CPU TDP	205 W	Intel® Xeon® Platinum 8280L / 8280M / 8280 CPU_28	●	●	3					●	3							
		Intel® Xeon® Platinum 8270 CPU_26C	●	●	3					●	3							
		Intel® Xeon® Platinum 8268 CPU_24C	●	●	3					●	3							
		Intel® Xeon® Gold 6246R CPU_16C	●	●														
		Intel® Xeon® Gold 6248R CPU_24C	●	●														
		Intel® Xeon® Gold 6258R CPU_28C	●	●														



Intel® Server System R1000WF Product Family Technical Product Specification

<b>Thermal Config Matrix</b> Normal operating mode "•"= Full support without limitation; "4,5"(Cell with number) = Conditional support with limitation (See notes at beginning of section) Blank Cell = Not supported		R1304 HDD WF								R1208 HDD WF							
		Classifications				A1	A2	A3	A4					A1	A2	A3	A4
ASHRAE (See note 1)	Max Ambient	15°C	20°C	25°C	27°C (1)	32°C	35°C	40°C	45°C	15°C	20°C	25°C	27°C (1)	32°C	35°C	40°C	45°C
	Altitude	900	900	900	900	900	900	900	900	900	900	900	900	900	900	900	900
	Intel® Xeon® Gold 6256 CPU_12C	•	•														
200 W	Intel® Xeon® Gold 6254 CPU_18C	•	•	3						•	3						
165 W	Intel® Xeon® Gold 6238R CPU_28C	•	•	•	•	•	•	•	3	•	•	•	•	•			
	Intel® Xeon® Gold 6240R CPU_24C	•	•	•	•	•	•	•	3	•	•	•	•	•			
	Intel® Xeon® Platinum 8276L / 8276M / 8276 CPU_28C	•	•	•	•	•	3			•	•	•	•	•	3		
	Intel® Xeon® Platinum 8260L / 8260M / 8260 CPU_24C	•	•	•	•	•	3			•	•	•	•	•	3		
	Intel® Xeon® Platinum 8260Y CPU_24/20/16C	•	•	•	•	•	•			•	•	•	•	•	•		
	Intel® Xeon® Gold 6246 CPU_12C	•	•	•	•	3	3			•	•	3					
	Intel® Xeon® Gold 6212U CPU_24C	•	•	•	•	•	•			•	•	•	•	•	•		
150 W	Intel® Xeon® Gold 5220R CPU_24C	•	•	•	•	•	•	•	3	•	•	•	•	•	•		
	Intel® Xeon® Gold 6208U CPU_16C	•	•	•	•	•	•	•	3	•	•	•	•	•	•		
	Intel® Xeon® Gold 6226R CPU_16C	•	•	•	•	•	•	•	3	•	•	•	•	•	•		
	Intel® Xeon® Gold 6230R CPU_26C	•	•	•	•	•	•	•	3	•	•	•	•	•	•		
	Intel® Xeon® Gold 6252 CPU_24C	•	•	•	•	•	•			•	•	•	•	•	•		
	Intel® Xeon® Gold 6252N CPU_24/8/16C	•	•	•	•	3	3			•	•	3	3	3	3		
	Intel® Xeon® Gold 6248 CPU_20C	•	•	•	•	•	•			•	•	•	•	•	•		
	Intel® Xeon® Gold 6240 CPU_18C	•	•	•	•	•	•			•	•	•	•	•	•		
	Intel® Xeon® Gold 6240Y CPU_18/14/8C	•	•	•	•	3	3			•	•	3	3	3	3		
	Intel® Xeon® Gold 6242 CPU_16C	•	•	•	•	•	3			•	•	•	•	•	3		

Intel® Server System R1000WF Product Family Technical Product Specification

<b>Thermal Config Matrix</b> Normal operating mode "•"= Full support without limitation; "4,5"(Cell with number) = Conditional support with limitation (See notes at beginning of section) Blank Cell = Not supported		R1304 HDD WF								R1208 HDD WF									
		Classifications				15°C	20°C	25°C	27°C (1)	A1	A2	A3	A4	15°C	20°C	25°C	27°C (1)	A1	A2
ASHRAE (See note 1)	Max Ambient	15°C	20°C	25°C	27°C (1)	32°C	35°C	40°C	45°C	15°C	20°C	25°C	27°C (1)	32°C	35°C	40°C	45°C		
	Altitude	900	900	900	900	900	900	900	900	900	900	900	900	900	900	900	900		
	Intel® Xeon® Gold 6244 CPU_8C	•	•	•	3	3	3			•	•	•	•	3	3				
	Intel® Xeon® Gold 6210U CPU_20C	•	•	•	•	•	•			•	•	•	•	•	•				
140 W	Intel® Xeon® Gold 6238 CPU_22C	•	•	•	•	•	•	•		•	•	•	•	•	•	•			
135 W	Intel® Xeon® Gold 6262V CPU_24C	•	•	•	•	•	•	•		•	•	•	•	•	•	•			
130 W	Intel® Xeon® Silver 4215R CPU_8C	•	•	•	•	•	•	•	3	•	•	•	•	•	•	3			
	Intel® Xeon® Gold 6234 CPU_8C	•	•	•	•	•	•	3		•	•	•	•	•	•	3			
125 W	Intel® Xeon® Gold 5220R CPU_18C	•	•	•	•	•	•	•	•	•	•	•	•	•	•	•	•		
	Intel® Xeon® Gold 5218R CPU_20C	•	•	•	•	•	•	•	•	•	•	•	•	•	•	•	•		
	Intel® Xeon® Silver 4216R CPU_16C	•	•	•	•	•	•	•	•	•	•	•	•	•	•	•	•		
	Intel® Xeon® Gold 6238T CPU_22C	•	•	•	•	•	•	•		•	•	•	•	•	•				
	Intel® Xeon® Gold 6230T CPU_20C	•	•	•	•	•	•	•	3	•	•	•	•	•	•				
	Intel® Xeon® Gold 6230 CPU_20C	•	•	•	•	•	•	•	3	•	•	•	•	•	•	•	3		
	Intel® Xeon® Gold 6230N CPU_6/14C	•	•	•	•	•	•	•		•	•	•	•	•	•	3			
	Intel® Xeon® Gold 6209U CPU_20C	•	•	•	•	•	•	•	3	•	•	•	•	•	•	•	•	3	
	Intel® Xeon® Gold 5220S CPU_18C	•	•	•	•	•	•	•	3	•	•	•	•	•	•	•	•	3	
	Intel® Xeon® Gold 5220 CPU_18C	•	•	•	•	•	•	•	3	•	•	•	•	•	•	•	•	3	
	Intel® Xeon® Gold 5218 CPU_16C	•	•	•	•	•	•	•	3	•	•	•	•	•	•	•	•	3	
	Intel® Xeon® Gold 5218B CPU_16C	•	•	•	•	•	•	•	3	•	•	•	•	•	•	•	•	3	
	Intel® Xeon® Platinum 8253 CPU_16C	•	•	•	•	•	•	•	3	•	•	•	•	•	•	•	•	3	
Intel® Xeon® Gold 6226 CPU_12C	•	•	•	•	•	•	•	3	•	•	•	•	•	•	•	•	3		
115 W	Intel® Xeon® Gold 6222V CPU_20C	•	•	•	•	•	•	3		•	•	•	•	•	3				

Intel® Server System R1000WF Product Family Technical Product Specification

<b>Thermal Config Matrix</b> Normal operating mode "•"= Full support without limitation; "4,5"(Cell with number) = Conditional support with limitation (See notes at beginning of section) Blank Cell = Not supported		R1304 HDD WF								R1208 HDD WF								
		Classifications				A1	A2	A3	A4					A1	A2	A3	A4	
ASHRAE (See note 1)	Max Ambient	15°C	20°C	25°C	27°C (1)	32°C	35°C	40°C	45°C	15°C	20°C	25°C	27°C (1)	32°C	35°C	40°C	45°C	
	Altitude	900	900	900	900	900	900	900	900	900	900	900	900	900	900	900	900	
	Intel® Xeon® Gold 5217 CPU_8C	•	•	•	•	•	•	3	3	•	•	•	•	•	•	3	3	
105 W	Intel® Xeon® Platinum 8256 CPU_4C	•	•	•	•	•	•	3	3	•	•	•	•	•	•	3	3	
	Intel® Xeon® Gold 5218N CPU_16/4/12C	•	•	•	•	•	•	•	•	•	•	•	•	•	•	•	3	
	Intel® Xeon® Gold 5220T CPU_18C	•	•	•	•	•	•	•	•	•	•	•	•	•	•	•	•	3
	Intel® Xeon® Gold 5218T CPU_16C	•	•	•	•	•	•	•	•	•	•	•	•	•	•	•	•	3
	Intel® Xeon® Gold 5222 CPU_4C	•	•	•	•	•	•	•	3	3	•	•	•	•	•	•	3	3
100 W	Intel® Xeon® Silver 4216 CPU_16C	•	•	•	•	•	•	•	3	•	•	•	•	•	•	•	•	3
	Intel® Xeon® Silver 4208R CPU_18C	•	•	•	•	•	•	•	•	•	•	•	•	•	•	•	•	•
	Intel® Xeon® Silver 4210R CPU_10C	•	•	•	•	•	•	•	•	•	•	•	•	•	•	•	•	•
	Intel® Xeon® Gold 5215R CPU_10C	•	•	•	•	•	•	•	•	•	•	•	•	•	•	•	•	3
	Intel® Xeon® Silver 4214R CPU_12C	•	•	•	•	•	•	•	•	•	•	•	•	•	•	•	•	3
95 W	Intel® Xeon® Silver 4210T CPU_10C	•	•	•	•	•	•	•	•	•	•	•	•	•	•	•	•	3
85 W	Intel® Xeon® Gold 5215 CPU_10C	•	•	•	•	•	•	•	•	•	•	•	•	•	•	•	•	•
	Intel® Xeon® Silver 4214 CPU_12C	•	•	•	•	•	•	•	•	•	•	•	•	•	•	•	•	•
	Intel® Xeon® Silver 4214Y CPU_12/10/8C	•	•	•	•	•	•	•	•	•	•	•	•	•	•	•	•	•
	Intel® Xeon® Silver 4210 CPU_10C	•	•	•	•	•	•	•	•	•	•	•	•	•	•	•	•	•
	Intel® Xeon® Silver 4215 CPU_8C	•	•	•	•	•	•	•	•	•	•	•	•	•	•	•	•	•
	Intel® Xeon® Silver 4208 CPU_8C	•	•	•	•	•	•	•	•	•	•	•	•	•	•	•	•	•
	Intel® Xeon® Bronze 3204 CPU_6C	•	•	•	•	•	•	•	•	•	•	•	•	•	•	•	•	•
Intel® Xeon® Bronze 3206R CPU_8C	•	•	•	•	•	•	•	•	•	•	•	•	•	•	•	•	•	
70 W	Intel® Xeon® Silver 4209T CPU_8C	•	•	•	•	•	•	•	•	•	•	•	•	•	•	•	•	•

Intel® Server System R1000WF Product Family Technical Product Specification

<b>Thermal Config Matrix</b> Normal operating mode "•"= Full support without limitation; "4,5"(Cell with number) = Conditional support with limitation (See notes at beginning of section) Blank Cell = Not supported		R1304 HDD WF								R1208 HDD WF							
		Classifications				A1	A2	A3	A4					A1	A2	A3	A4
ASHRAE (See note 1)	Max Ambient	15°C	20°C	25°C	27°C (1)	32°C	35°C	40°C	45°C	15°C	20°C	25°C	27°C (1)	32°C	35°C	40°C	45°C
	Altitude	900	900	900	900	900	900	900	900	900	900	900	900	900	900	900	900
Memory Type	AEP SDP 128 GB	•	•	•	•	•	•	3	3	•	•	•	•	•	•	•	•
	AEP DDQ 256 GB	•	•	•	•	•	•	3	3	•	•	•	•	•	•	•	•
	AEP QDP 512 GB	•	•	•	•	27	27	3	3	•	•	•	•	•	•	•	3
	RDIMM-2Rx8, 1Rx4, 1Rx8	•	•	•	•	•	•	•	•	•	•	•	•	•	•	•	•
	RDIMM-DRx4	•	•	•	•	•	•	•	•	•	•	•	•	•	•	•	•
	LRDIMM-QRx4 DDP	•	•	•	•	•	•	3	3	•	•	•	•	•	•	•	3
Add-in Cards (See note 5)	Riser #1 - Bottom Slot (1U riser and 2U riser)	•	•	•	•	•	•	•	•	•	•	•	•	•	•	•	•
	Riser #2 - Bottom Slot (1U riser and 2U riser)	•	•	•	•	•	•	•	•	•	•	•	•	•	•	•	•
SAS and OCP Modules (See note 4)	Intel® Integrated RAID Modules (Mezzanine cards)	•	•	•	•	•	•	•	•	•	•	•	•	•	•	•	•
	16 port tri mode mezzanine	•	•	•	•	•	•	26	26	•	•	•	•	•	•	26	26
	IFT carrier AIC	•	•	•	•	•	•	•	•	•	•	•	•	•	•	•	•
	IFT carrier Mezzanine	•	•	•	•	•	•	•	•	•	•	•	•	•	•	•	•
	Dual 10GBase-T Taylor Canal	•	•	•	•	•	•	•	•	•	•	•	•	•	•	•	•
	Dual SFP+ Cascade Canal	•	•	•	•	•	•	•	•	•	•	•	•	•	•	•	•
	Quad SFP+ Cascade Canal	•	•	•	•	•	•	•	•	•	•	•	•	•	•	•	•
Battery Backup (See note 9)	BBU (rated to 45C)	•	•	•	•	•	•	•	•	•	•	•	•	•	•	•	•
	Supercap (rated to 55C)	•	•	•	•	•	•	•	•	•	•	•	•	•	•	•	•
	Cache Offload Module (rated to 55C)	•	•	•	•	•	•	•	•	•	•	•	•	•	•	•	•
2.5" SFF NVMe* SSD	1600GB/2TB																
	800GB																

<b>Thermal Config Matrix</b> Normal operating mode "•"= Full support without limitation; "4,5"(Cell with number) = Conditional support with limitation (See notes at beginning of section) Blank Cell = Not supported		R1304 HDD WF								R1208 HDD WF							
		Classifications				A1	A2	A3	A4					A1	A2	A3	A4
ASHRAE (See note 1)	Max Ambient	15°C	20°C	25°C	27°C (1)	32°C	35°C	40°C	45°C	15°C	20°C	25°C	27°C (1)	32°C	35°C	40°C	45°C
	Altitude	900	900	900	900	900	900	900	900	900	900	900	900	900	900	900	900
(DC P3700/P3500) (See note 22)	600GB																
	400GB																
	200GB																
SATA HDD	Up to 2 TB	•	•	•	•	•	•	•	•	•	•	•	•	•	•	•	•
PCIe SSD AIC FF (DC P3700/P3500) (See note 8)	1600GB/2TB	•	•	•	•	•	•	•	•	•	•	•	•	•	•	•	•
	800GB	•	•	•	•	•	•	•	•	•	•	•	•	•	•	•	•
	600GB	•	•	•	•	•	•	•	•	•	•	•	•	•	•	•	•
	400GB	•	•	•	•	•	•	•	•	•	•	•	•	•	•	•	•
	200GB	•	•	•	•	•	•	•	•	•	•	•	•	•	•	•	•
M.2 Sustained Max Power (TDP)	Intel 120G and 80G SATA	•	•	•	•	•	•	13	13	•	•	•	•	•	•	13	13
	non-Intel M.2	•	•	•	•	•	•	15	15	•	•	•	•	•	•	15	15
M.2 Light Workload (See note 14)	Intel 120G and 80G SATA	•	•	•	•	•	•	•	13	•	•	•	•	•	•	•	13
	non-Intel M.2	•	•	•	•	•	•	•	15	•	•	•	•	•	•	•	15

**Table 61. Thermal configuration tables for the system in “normal” operating mode for R1208 NVMe\* WF**

<b>Thermal Config Matrix</b> <b>Normal operating mode</b> "•"= Full support without limitation; "4,5"(Cell with number) = Conditional support with limitation (See notes at beginning of section) Blank Cell = Not supported			R1208 NVMe* WF							
<b>ASHRAE</b> (See note 1)	<b>Classifications</b>						A1	A2	A3	A4
	<b>Max Ambient</b>		15°C	20°C	25°C	27°C (1)	32°C	35°C	40°C	45°C
	<b>Altitude</b>		900	900	900	900	900	900	900	900
<b>PS</b> (See note 6)		1300 W AC	•	•	•	•	•	•	•	•
		1100W AC	•	•	•	•	•	•	•	•
		750W AC								
<b>CPU TDP</b>	205 W	Intel® Xeon® Platinum 8280L / 8280M / 8280 CPU_28	3							
		Intel® Xeon® Platinum 8270 CPU_26C	3							
		Intel® Xeon® Platinum 8268 CPU_24C	3							
		Intel® Xeon® Gold 6246R CPU_16C								
		Intel® Xeon® Gold 6248R CPU_24C								
		Intel® Xeon® Gold 6258R CPU_28C								
	200 W	Intel® Xeon® Gold 6254 CPU_18C	•	3						
	165 W	Intel® Xeon® Gold 6238R CPU_28C	•	•	•	•	3			
		Intel® Xeon® Gold 6240R CPU_24C	•	•	•	•	3			
		Intel® Xeon® Platinum 8276L / 8276M / 8276 CPU_28C	•	•	•	•				
		Intel® Xeon® Platinum 8260L / 8260M / 8260 CPU_24C	•	•	•	3				
		Intel® Xeon® Platinum 8260Y CPU_24/20/16C	•	•	•	3				
		Intel® Xeon® Gold 6246 CPU_12C	•	3						

Intel® Server System R1000WF Product Family Technical Product Specification

<b>Thermal Config Matrix</b> Normal operating mode "•"= Full support without limitation; "4,5"(Cell with number) = Conditional support with limitation (See notes at beginning of section) Blank Cell = Not supported		R1208 NVMe* WF							
		Classifications				A1	A2	A3	A4
ASHRAE (See note 1)	Max Ambient	15°C	20°C	25°C	27°C (1)	32°C	35°C	40°C	45°C
	Altitude	900	900	900	900	900	900	900	900
	Intel® Xeon® Gold 6212U CPU_24C	•	•	•	3				
150 W	Intel® Xeon® Gold 5220R CPU_24C	•	•	•	•	3			
	Intel® Xeon® Gold 6208U CPU_16C	•	•	•	•	3			
	Intel® Xeon® Gold 6226R CPU_16C	•	•	•	•	3			
	Intel® Xeon® Gold 6230R CPU_26C	•	•	•	•	3			
	Intel® Xeon® Gold 6252 CPU_24C	•	•	•	•	3			
	Intel® Xeon® Gold 6252N CPU_24/8/16C	•	3						
	Intel® Xeon® Gold 6248 CPU_20C	•	•	•	•	3			
	Intel® Xeon® Gold 6240 CPU_18C	•	•	•	•	3			
	Intel® Xeon® Gold 6240Y CPU_18/14/8C	•	3						
	Intel® Xeon® Gold 6242 CPU_16C	•	•	•	•	3			
	Intel® Xeon® Gold 6244 CPU_8C	•	3	3	3				
	Intel® Xeon® Gold 6210U CPU_20C	•	•	•	•	3			
140 W	Intel® Xeon® Gold 6238 CPU_22C	•	•	•	•	•	•		
135 W	Intel® Xeon® Gold 6262V CPU_24C	•	•	•	•	•	•		
130 W	Intel® Xeon® Silver 4215R CPU_8C	•	•	•	•	3			
	Intel® Xeon® Gold 6234 CPU_8C	•	•	•	•	3	3		
125 W	Intel® Xeon® Gold 5220R CPU_18C	•	•	•	•	•	•	3	
	Intel® Xeon® Gold 5218R CPU_20C	•	•	•	•	•	•	3	

Intel® Server System R1000WF Product Family Technical Product Specification

<b>Thermal Config Matrix</b> Normal operating mode "•"= Full support without limitation; "4,5"(Cell with number) = Conditional support with limitation (See notes at beginning of section) Blank Cell = Not supported		R1208 NVMe* WF							
		Classifications				A1	A2	A3	A4
ASHRAE (See note 1)	Max Ambient	15°C	20°C	25°C	27°C (1)	32°C	35°C	40°C	45°C
	Altitude	900	900	900	900	900	900	900	900
	Intel® Xeon® Silver 4216R CPU_16C	•	•	•	•	•	•	3	
	Intel® Xeon® Gold 6238T CPU_22C	•	•	•	•	3			
	Intel® Xeon® Gold 6230T CPU_20C	•	•	•	•	3			
	Intel® Xeon® Gold 6230 CPU_20C	•	•	•	•	•	•		
	Intel® Xeon® Gold 6230N CPU_6/14C	•	•	•	•	3	3		
	Intel® Xeon® Gold 6209U CPU_20C	•	•	•	•	•	•		
	Intel® Xeon® Gold 5220S CPU_18C	•	•	•	•	•	•		
	Intel® Xeon® Gold 5220 CPU_18C	•	•	•	•	•	•		
	Intel® Xeon® Gold 5218 CPU_16C	•	•	•	•	•	•		
	Intel® Xeon® Gold 5218B CPU_16C	•	•	•	•	•	•		
	Intel® Xeon® Platinum 8253 CPU_16C	•	•	•	•	•	•		
	Intel® Xeon® Gold 6226 CPU_12C	•	•	•	•	•	•		
115 W	Intel® Xeon® Gold 6222V CPU_20C				3	3			
	Intel® Xeon® Gold 5217 CPU_8C	•	•	•	•	•	3		
105 W	Intel® Xeon® Platinum 8256 CPU_4C	•	•	•	•	3	3		
	Intel® Xeon® Gold 5218N CPU_16/4/12C	•	•	•	•	•	•	3	
	Intel® Xeon® Gold 5220T CPU_18C	•	•	•	•	•	•	3	
	Intel® Xeon® Gold 5218T CPU_16C	•	•	•	•	•	•	3	
	Intel® Xeon® Gold 5222 CPU_4C	•	•	•	•	3	3		
100 W	Intel® Xeon® Silver 4216 CPU_16C	•	•	•	•	•	•	3	
	Intel® Xeon® Silver 4208R CPU_18C	•	•	•	•	•	•	3	



Intel® Server System R1000WF Product Family Technical Product Specification

<b>Thermal Config Matrix</b> Normal operating mode "•"= Full support without limitation; "4,5"(Cell with number) = Conditional support with limitation (See notes at beginning of section) Blank Cell = Not supported		R1208 NVMe* WF									
		Classifications				A1	A2	A3	A4		
ASHRAE (See note 1)	Max Ambient	15°C	20°C	25°C	27°C (1)	32°C	35°C	40°C	45°C		
	Altitude	900	900	900	900	900	900	900	900		
		Intel® Xeon® Silver 4210R CPU_10C	•	•	•	•	•	•	3		
		Intel® Xeon® Gold 5215R CPU_10C	•	•	•	•	•	•	•	3	
		Intel® Xeon® Silver 4214R CPU_12C	•	•	•	•	•	•	•	3	
	95 W	Intel® Xeon® Silver 4210T CPU_10C	•	•	•	•	•	•	•	3	
	85 W	Intel® Xeon® Gold 5215 CPU_10C	•	•	•	•	•	•	•	•	3
		Intel® Xeon® Silver 4214 CPU_12C	•	•	•	•	•	•	•	3	3
		Intel® Xeon® Silver 4214Y CPU_12/10/8C	•	•	•	•	•	•	•	3	3
		Intel® Xeon® Silver 4210 CPU_10C	•	•	•	•	•	•	•	3	3
		Intel® Xeon® Silver 4215 CPU_8C	•	•	•	•	•	•	•	3	3
		Intel® Xeon® Silver 4208 CPU_8C	•	•	•	•	•	•	•	3	3
		Intel® Xeon® Bronze 3204 CPU_6C	•	•	•	•	•	•	•	3	3
	70 W	Intel® Xeon® Bronze 3206R CPU_8C	•	•	•	•	•	•	•	•	
		Intel® Xeon® Silver 4209T CPU_8C	•	•	•	•	•	•	•	•	3
	Memory Type	AEP SDP 128 GB	•	•	•	•	•	•	•	•	•
AEP DDQ 256 GB		•	•	•	•	•	•	•	•	3	
AEP QDP 512 GB		•	•	•	•	•	•	•	•	3	
RDIMM-2Rx8, 1Rx4, 1Rx8		•	•	•	•	•	•	•	•	•	
RDIMM-DRx4		•	•	•	•	•	•	•	•	•	
LRDIMM-QRx4 DDP		•	•	•	•	•	•	•	3	3	
Add-in Cards (See note 5)	Riser #1 - Bottom Slot (1U riser and 2U riser)	•	•	•	•	•	•	•	•	•	

Intel® Server System R1000WF Product Family Technical Product Specification

<b>Thermal Config Matrix</b> Normal operating mode "•"= Full support without limitation; "4,5"(Cell with number) = Conditional support with limitation (See notes at beginning of section) Blank Cell = Not supported		R1208 NVMe* WF							
		Classifications				A1	A2	A3	A4
ASHRAE (See note 1)	Max Ambient	15°C	20°C	25°C	27°C (1)	32°C	35°C	40°C	45°C
	Altitude	900	900	900	900	900	900	900	900
		Riser #2 - Bottom Slot (1U riser and 2U riser)	•	•	•	•	•	•	•
SAS and OCP Modules (See note 4)	Intel® Integrated RAID Modules (Mezzanine cards)	•	•	•	•	•	•	•	•
	16 port tri mode mezzanine	•	•	•	•	•	•	26	26
	IFT carrier AIC	•	•	•	•	•	•	•	•
	IFT carrier Mezzanine	•	•	•	•	•	•	•	•
	Dual 10GBase-T Taylor Canal	•	•	•	•	•	•	•	•
	Dual SFP+ Cascade Canal	•	•	•	•	•	•	•	•
	Quad SFP+ Cascade Canal	•	•	•	•	•	•	•	•
Battery Backup (See note 9)	1GBase-T Quad Main Canal	•	•	•	•	•	•	•	•
	BBU (rated to 45C)	•	•	•	•	•	•	•	
	Supercap (rated to 55C)	•	•	•	•	•	•	•	
2.5" SFF NVMe* SSD (DC P3700/P3500) (See note 22)	Cache Offload Module (rated to 55C)	•	•	•	•	•	•	•	•
	1600GB/2TB	•	•	•	•	•	•	•	•
	800GB	•	•	•	•	•	•	•	•
	600GB	•	•	•	•	•	•	•	•
	400GB	•	•	•	•	•	•	•	•
SATA HDD	200GB	•	•	•	•	•	•	•	•
	Up to 2 TB	•	•	•	•	•	•	•	•
PCIe SSD AIC FF (DC P3700/P3500) (See note 8)	1600GB/2TB	•	•	•	•	•	•	•	•
	800GB	•	•	•	•	•	•	•	•
	600GB	•	•	•	•	•	•	•	•
	400GB	•	•	•	•	•	•	•	•

<b>Thermal Config Matrix</b> Normal operating mode "•"= Full support without limitation; "4,5"(Cell with number) = Conditional support with limitation (See notes at beginning of section) Blank Cell = Not supported		R1208 NVMe* WF							
		Classifications				A1	A2	A3	A4
ASHRAE (See note 1)	Max Ambient	15°C	20°C	25°C	27°C (1)	32°C	35°C	40°C	45°C
	Altitude	900	900	900	900	900	900	900	900
	200GB	•	•	•	•	•	•	•	•
	M.2 Sustained Max Power (TDP)	Intel 120G and 80G SATA	•	•	•	•	•	•	13
	non-Intel M.2	•	•	•	•	•	•	15	15
M.2 Light Workload [See note 14]	Intel 120G and 80G SATA	•	•	•	•	•	•	•	13
	non-Intel M.2	•	•	•	•	•	•	•	15

**Table 62. Thermal configuration table for system in "fan fail" operating mode for R1304 HDD WF and R1208 HDD WF**

<b>Thermal Config Matrix</b> <b>Fan Fail mode</b> "●"= Full support without limitation; "4,5"(Cell with number) = Conditional support with limitation (See notes at beginning of section) Blank Cell = Not supported		R1304 HDD WF								R1208 HDD WF								
		Classifications				A1	A2	A3	A4					A1	A2	A3	A4	
ASHRAE (See note 1)	Max Ambient	15°C	20°C	25°C	27°C (1)	32°C	35°C	40°C	45°C	15°C	20°C	25°C	27°C (1)	32°C	35°C	40°C	45°C	
	Altitude	900	900	900	900	900	900	900	900	900	900	900	900	900	900	900	900	
PS (See note 6)	1300 W AC	2	2	2	2	2	2	2	2	2	2	2	2	2	2	2	2	
	1100W AC	2	2	2	2	2	2	2	2	2	2	2	2	2	2	2	2	
	750W AC	2,20,24	2,20,24	2,20,24	2,20,24	2,21,24	2,21,24	2	2	2,20,24	2,20,24	2,20,24	2,20,24	2,21	2,21	2	2	
CPU TDP	205 W	Intel® Xeon® Platinum 8280L / 8280M / 8280 CPU_28	23	23						23								
		Intel® Xeon® Platinum 8270 CPU_26C	23	23						23								
		Intel® Xeon® Platinum 8268 CPU_24C	23	23						23								
		Intel® Xeon® Gold 6246R CPU_16C	23	23														
		Intel® Xeon® Gold 6248R CPU_24C	23	23														
		Intel® Xeon® Gold 6258R CPU_28C	23	23														
	165 W	Intel® Xeon® Platinum 8276L / 8276M / 8276 CPU_28C	23	23	23	23	23	23			23	23	23	23	23	23		
		Intel® Xeon® Platinum 8260L / 8260M / 8260 CPU_24C	23	23	23	23	23	23			23	23	23	23	23	23		
		Intel® Xeon® Platinum 8260Y CPU_24/20/16C	23	23	23	23	23	23			23	23	23	23	23	23		
		Intel® Xeon® Gold 6246 CPU_12C	23	23	23	23												
		Intel® Xeon® Gold 6212U CPU_24C	23	23	23	23	23	23			23	23	23	23	23	23		
		Intel® Xeon® Gold 6238R CPU_28C	23	23	23	23	23	23			23	23	23	23	23	23		
		Intel® Xeon® Gold 6240R CPU_24C	23	23	23	23	23	23			23	23	23	23	23	23		

Intel® Server System R1000WF Product Family Technical Product Specification

<b>Thermal Config Matrix</b> <b>Fan Fail mode</b> "•"= Full support without limitation; "4,5"(Cell with number) = Conditional support with limitation (See notes at beginning of section) Blank Cell = Not supported		R1304 HDD WF								R1208 HDD WF							
		Classifications				A1	A2	A3	A4					A1	A2	A3	A4
ASHRAE (See note 1)	Max Ambient	15°C	20°C	25°C	27°C (1)	32°C	35°C	40°C	45°C	15°C	20°C	25°C	27°C (1)	32°C	35°C	40°C	45°C
	Altitude	900	900	900	900	900	900	900	900	900	900	900	900	900	900	900	900
150 W	Intel® Xeon® Gold 6252 CPU_24C	23	23	23	23	23	23			23	23	23	23	23	23		
	Intel® Xeon® Gold 6252N CPU_24/8/16C	23	23	23	23	23	23			23	23	23	23	23	23		
	Intel® Xeon® Gold 6248 CPU_20C	23	23	23	23	23	23			23	23	23	23	23	23		
	Intel® Xeon® Gold 6240 CPU_18C	23	23	23	23	23	23			23	23	23	23	23	23		
	Intel® Xeon® Gold 6240Y CPU_18/14/8C	23	23	23	23	23	23			23	23	23	23	23	23		
	Intel® Xeon® Gold 6242 CPU_16C	23	23	23	23	23	23			23	23	23	23	23	23		
	Intel® Xeon® Gold 6244 CPU_8C	23	23	23	23	23	23			23	23	23	23	23	23		
	Intel® Xeon® Gold 6210U CPU_20C	23	23	23	23	23	23			23	23	23	23	23	23		
	Intel® Xeon® Gold 5220R CPU_24C	23	23	23	23	23	23			23	23	23	23	23	23		
	Intel® Xeon® Gold 6208U CPU_16C	23	23	23	23	23	23			23	23	23	23	23	23		
	Intel® Xeon® Gold 6226R CPU_16C	23	23	23	23	23	23			23	23	23	23	23	23		
Intel® Xeon® Gold 6230R CPU_26C	23	23	23	23	23	23			23	23	23	23	23	23			
140 W	Intel® Xeon® Gold 6238 CPU_22C	23	23	23	23	23	23	23		23	23	23	23	23	23	23	
135 W	Intel® Xeon® Gold 6262V CPU_24C	23	23	23	23	23	23	23		23	23	23	23	23	23	23	
130 W	Intel® Xeon® Silver 4215R CPU_8C	23	23	23	23	23	23	23		23	23	23	23	23	23	23	
	Intel® Xeon® Gold 6234 CPU_8C	23	23	23	23	23	23	23		23	23	23	23	23	23	23	
125 W	Intel® Xeon® Gold 6238T CPU_22C	23	23	23	23	23	23	23		23	23	23	23	23	23		
	Intel® Xeon® Gold 6230T CPU_20C	23	23	23	23	23	23	23		23	23	23	23	23	23		
	Intel® Xeon® Gold 6230 CPU_20C	23	23	23	23	23	23	23	23	23	23	23	23	23	23	23	23
	Intel® Xeon® Gold 6230N CPU_6/14C	23	23	23	23	23	23	23	23	23	23	23	23	23	23	23	23

Intel® Server System R1000WF Product Family Technical Product Specification

<b>Thermal Config Matrix</b> <i>Fan Fail mode</i> "●"= Full support without limitation; "4,5"(Cell with number) = Conditional support with limitation (See notes at beginning of section) Blank Cell = Not supported		R1304 HDD WF								R1208 HDD WF							
		Classifications				A1	A2	A3	A4					A1	A2	A3	A4
ASHRAE (See note 1)	Max Ambient	15°C	20°C	25°C	27°C (1)	32°C	35°C	40°C	45°C	15°C	20°C	25°C	27°C (1)	32°C	35°C	40°C	45°C
	Altitude	900	900	900	900	900	900	900	900	900	900	900	900	900	900	900	900
	Intel® Xeon® Gold 6209U CPU_20C	23	23	23	23	23	23	23	23	23	23	23	23	23	23	23	23
	Intel® Xeon® Gold 5220S CPU_18C	23	23	23	23	23	23	23	23	23	23	23	23	23	23	23	23
	Intel® Xeon® Gold 5220 CPU_18C	23	23	23	23	23	23	23	23	23	23	23	23	23	23	23	23
	Intel® Xeon® Gold 5218 CPU_16C	23	23	23	23	23	23	23	23	23	23	23	23	23	23	23	23
	Intel® Xeon® Gold 5218B CPU_16C	23	23	23	23	23	23	23	23	23	23	23	23	23	23	23	23
	Intel® Xeon® Platinum 8253 CPU_16C	23	23	23	23	23	23	23	23	23	23	23	23	23	23	23	23
	Intel® Xeon® Gold 6226 CPU_12C	23	23	23	23	23	23	23	23	23	23	23	23	23	23	23	23
	"Intel® Xeon® Gold 5220R CPU_18C	23	23	23	23	23	23	23	23	23	23	23	23	23	23	23	23
	Intel® Xeon® Gold 5218R CPU_20C	23	23	23	23	23	23	23	23	23	23	23	23	23	23	23	23
	Intel® Xeon® Silver 4216R CPU_16C	23	23	23	23	23	23	23	23	23	23	23	23	23	23	23	23
115 W	Intel® Xeon® Gold 6222V CPU_20C	23	23	23	23	23	23			●	23	23	23	23	23	23	
	Intel® Xeon® Gold 5217 CPU_8C	23	23	23	23	23	23	23	23	●	23	23	23	23	23	23	23
105 W	Intel® Xeon® Platinum 8256 CPU_4C	23	23	23	23	23	23	23	23	●	23	23	23	23	23	23	23
	Intel® Xeon® Gold 5218N CPU_16/4/12C	23	23	23	23	23	23	23	23	●	23	23	23	23	23	23	23
	Intel® Xeon® Gold 5220T CPU_18C	23	23	23	23	23	23	23	23	●	23	23	23	23	23	23	
	Intel® Xeon® Gold 5218T CPU_16C	23	23	23	23	23	23	23	23	●	23	23	23	23	23	23	
	Intel® Xeon® Gold 5222 CPU_4C	23	23	23	23	23	23	23	23	●	23	23	23	23	23	23	23
100 W	Intel® Xeon® Silver 4216 CPU_16C	23	23	23	23	23	23	23	23	●	23	23	23	23	23	23	23
	Intel® Xeon® Silver 4208R CPU_18C	23	23	23	23	23	23	23	23	●	23	23	23	23	23	23	23
	Intel® Xeon® Silver 4210R CPU_10C	23	23	23	23	23	23	23	23	●	23	23	23	23	23	23	23
	Intel® Xeon® Gold 5215R CPU_10C	23	23	23	23	23	23	23	23	●	23	23	23	23	23	23	23
	Intel® Xeon® Silver 4214R CPU_12C	23	23	23	23	23	23	23	23	●	23	23	23	23	23	23	23

Intel® Server System R1000WF Product Family Technical Product Specification

<b>Thermal Config Matrix</b> <i>Fan Fail mode</i> "•"= Full support without limitation; "4,5"(Cell with number) = Conditional support with limitation (See notes at beginning of section) Blank Cell = Not supported		R1304 HDD WF								R1208 HDD WF									
		Classifications						A1	A2	A3	A4					A1	A2	A3	A4
ASHRAE (See note 1)		Max Ambient	15°C	20°C	25°C	27°C (1)	32°C	35°C	40°C	45°C	15°C	20°C	25°C	27°C (1)	32°C	35°C	40°C	45°C	
		Altitude	900	900	900	900	900	900	900	900	900	900	900	900	900	900	900	900	
95 W	Intel® Xeon® Silver 4210T CPU_10C	23	23	23	23	23	23	23	23	23	•	23	23	23	23	23	23	23	
	85 W	Intel® Xeon® Gold 5215 CPU_10C	•	23	23	23	23	23	23	23	23	•	•	•	23	23	23	23	23
		Intel® Xeon® Silver 4214 CPU_12C	•	23	23	23	23	23	23	23	23	•	•	•	23	23	23	23	23
		Intel® Xeon® Silver 4214Y CPU_12/10/8C	•	23	23	23	23	23	23	23	23	•	•	23	23	23	23	23	23
		Intel® Xeon® Silver 4210 CPU_10C	•	23	23	23	23	23	23	23	23	•	•	•	23	23	23	23	23
		Intel® Xeon® Silver 4215 CPU_8C	•	23	23	23	23	23	23	23	23	•	•	•	23	23	23	23	23
		Intel® Xeon® Silver 4208 CPU_8C	•	23	23	23	23	23	23	23	23	•	•	•	23	23	23	23	23
		Intel® Xeon® Bronze 3204 CPU_6C	•	23	23	23	23	23	23	23	23	•	•	•	23	23	23	23	23
		Intel® Xeon® Bronze 3206R CPU_8C	•	23	23	23	23	23	23	23	23	•	•	•	23	23	23	23	23
70 W	Intel® Xeon® Silver 4209T CPU_8C	•	•	•	•	23	23	23	23	23	•	•	•	23	23	23	23	23	
Memory Type	AEP SDP 128 GB	•	•	•	•	3	3	3	3	3	•	•	•	•	•	•	3	3	
	AEP DDQ 256 GB	•	•	•	•	3	3	3	3	3	•	•	•	•	•	•	3	3	
	AEP QDP 512 GB	3	3	3	3	3	3	3	3	3	•	•	•	•	3	3	3	3	
	RDIMM-2Rx8, 1Rx4, 1Rx8	•	•	•	•	•	•	•	•	•	•	•	•	•	•	•	•	•	
	RDIMM-DRx4	•	•	•	•	•	•	•	•	•	•	•	•	•	•	•	•	•	
	LRDIMM-QRx4 DDP	•	•	•	•	3	3	3	3	3	•	•	•	•	3	3	3	3	
Add-in Cards (See note 5)	Riser #1 - Bottom Slot (1U riser and 2U riser)	•	•	•	•	•	•	•	•	•	•	•	•	•	•	•	•	•	
	Riser #2 - Bottom Slot (1U riser and 2U riser)	•	•	•	•	•	•	•	•	•	•	•	•	•	•	•	•	•	
3rd PCI Riser	Riser #3 - Bottom Slot																		
	Riser #3 - Top Slot																		
SAS and OCP Modules	Intel® Integrated RAID Modules (Mezzanine cards)	•	•	•	•	•	•	•	•	•	•	•	•	•	•	•	•	•	

Intel® Server System R1000WF Product Family Technical Product Specification

<b>Thermal Config Matrix</b> <b>Fan Fail mode</b> "•"= Full support without limitation; "4,5"(Cell with number) = Conditional support with limitation (See notes at beginning of section) Blank Cell = Not supported		R1304 HDD WF								R1208 HDD WF							
		Classifications				A1	A2	A3	A4					A1	A2	A3	A4
ASHRAE (See note 1)	Max Ambient	15°C	20°C	25°C	27°C (1)	32°C	35°C	40°C	45°C	15°C	20°C	25°C	27°C (1)	32°C	35°C	40°C	45°C
	Altitude	900	900	900	900	900	900	900	900	900	900	900	900	900	900	900	900
(See note 4)	16 port tri mode mezzanine	•	•	•	•	26	26	26	26	•	•	•	•	26	26	26	26
	IFT carrier AIC	26	26	26	26	26	26	26	26	26	26	26	26	26	26	26	26
	IFT carrier Mezzanine	26	26	26	26	26	26	26	26	26	26	26	26	26	26	26	26
	Dual 10GBase-T Taylor Canal	•	•	•	•	•	•	•	•	•	•	•	•	•	•	•	•
	Dual SFP+ Cascade Canal	•	•	•	•	12	12	13	14	•	•	•	•	12	12	13	14
	Quad SFP+ Cascade Canal	•	•	•	•	•	•	•	•	•	•	•	•	•	•	•	•
	1GBase-T Quad Main Canal	•	•	•	•	•	•	•	•	•	•	•	•	•	•	•	•
Battery Backup (See note 9)	BBU (rated to 45C)	•	•	•	•	•	•			•	•	•	•	•	•		
	Supercap (rated to 55C)	•	•	•	•	•	•			•	•	•	•	•	•		
	Cache Offload Module (rated to 55C)	•	•	•	•	•	•	•	•	•	•	•	•	•	•	•	•
2.5" SFF NVMe* SSD (DC P3700/P3500) (See note 22)	1600GB/2TB																
	800GB																
	600GB																
	400GB																
	200GB																
SATA HDD	Up to 2 TB	•	•	•	•	•	•	•	•	•	•	•	•	•	•	•	•
PCIe SSD AIC FF (DC P3700/P3500) (See note 8)	1600GB/2TB	•	•	•	•	•	•	•	•	•	•	•	•	•	•	•	•
	800GB	•	•	•	•	•	•	•	•	•	•	•	•	•	•	•	•
	600GB	•	•	•	•	•	•	•	•	•	•	•	•	•	•	•	•
	400GB	•	•	•	•	•	•	•	•	•	•	•	•	•	•	•	•
	200GB	•	•	•	•	•	•	•	•	•	•	•	•	•	•	•	•
M.2 Sustained Max Power (TDP)	Intel 120G and 80G SATA	•	•	•	•	13	13	13	13	•	•	•	•	•	•	13	13
	non-Intel M.2	•	•	•	•	15	15	15	15	•	•	•	•	•	•	15	15



<b>Thermal Config Matrix</b> <i>Fan Fail mode</i> "•"= Full support without limitation; "4,5"(Cell with number) = Conditional support with limitation (See notes at beginning of section) Blank Cell = Not supported		R1304 HDD WF								R1208 HDD WF								
		Classifications				A1	A2	A3	A4					A1	A2	A3	A4	
ASHRAE (See note 1)	Max Ambient	15°C	20°C	25°C	27°C (1)	32°C	35°C	40°C	45°C	15°C	20°C	25°C	27°C (1)	32°C	35°C	40°C	45°C	
	Altitude	900	900	900	900	900	900	900	900	900	900	900	900	900	900	900	900	900
M.2 Light Workload (See note 14)	Intel 120G and 80G SATA	•	•	•	•	13	13	13	13	•	•	•	•	•	•	•	•	13
	non-Intel M.2	•	•	•	•	15	15	15	15	•	•	•	•	•	•	•	•	15

**Table 63. Thermal configuration table for system in “fan fail” operating mode for R1208 NVMe\* WF**

<b>Thermal Config Matrix</b> <i>Fan Fail mode</i> "•"= Full support without limitation; "4,5"(Cell with number) = Conditional support with limitation (See notes at beginning of section) Blank Cell = Not supported		R1208 NVMe* WF								
		Classifications		A1	A2	A3	A4			
ASHRAE (See note 1)	Max Ambient	15°C	20°C	25°C	27°C (1)	32°C	35°C	40°C	45°C	
	Altitude	900	900	900	900	900	900	900	900	
	PS (See note 6)	1300 W AC	2	2	2	2		2	2	2
1100W AC		2	2	2	2		2	2	2	
750W AC										
CPU TDP	205 W	Intel® Xeon® Platinum 8280L / 8280M / 8280 CPU_28								
		Intel® Xeon® Platinum 8270 CPU_26C								
		Intel® Xeon® Platinum 8268 CPU_24C								
		Intel® Xeon® Gold 6246R CPU_16C								
		Intel® Xeon® Gold 6248R CPU_24C								
		Intel® Xeon® Gold 6258R CPU_28C								

Intel® Server System R1000WF Product Family Technical Product Specification

<b>Thermal Config Matrix</b> <b>Fan Fail mode</b> "•"= Full support without limitation; "4,5"(Cell with number) = Conditional support with limitation (See notes at beginning of section) Blank Cell = Not supported		R1208 NVMe* WF								
						A1	A2	A3	A4	
ASHRAE (See note 1)	Classifications	15°C	20°C	25°C	27°C (1)	32°C	35°C	40°C	45°C	
	Max Ambient	900	900	900	900	900	900	900	900	
	Altitude									
		Intel® Xeon® Gold 6256 CPU_12C								
	200 W	Intel® Xeon® Gold 6254 CPU_18C								
	165 W	Intel® Xeon® Gold 6238R CPU_28C	23	23	23	23	23			
		Intel® Xeon® Gold 6240R CPU_24C	23	23	23	23	23			
		Intel® Xeon® Platinum 8276L / 8276M / 8276 CPU_28C	23	23	23	23	23			
		Intel® Xeon® Platinum 8260L / 8260M / 8260 CPU_24C								
		Intel® Xeon® Platinum 8260Y CPU_24/20/16C	23	23	23	23	23			
Intel® Xeon® Gold 6246 CPU_12C		23	23	23	23	23				
Intel® Xeon® Gold 6212U CPU_24C		23	23	23	23	23				
150 W	Intel® Xeon® Gold 5220R CPU_24C	23	23	23	23					
	Intel® Xeon® Gold 6208U CPU_16C	23	23	23	23					
	Intel® Xeon® Gold 6226R CPU_16C	23	23	23	23					
	Intel® Xeon® Gold 6230R CPU_26C	23	23	23	23					
	Intel® Xeon® Gold 6252 CPU_24C	23	23	23	23					
	Intel® Xeon® Gold 6252N CPU_24/8/16C	23	23	23	23					
	Intel® Xeon® Gold 6248 CPU_20C	23	23	23	23					
	Intel® Xeon® Gold 6240 CPU_18C	23	23	23	23					
	Intel® Xeon® Gold 6240Y CPU_18/14/8C	23	23	23	23					

Intel® Server System R1000WF Product Family Technical Product Specification

<b>Thermal Config Matrix</b> <b>Fan Fail mode</b> "•"= Full support without limitation; "4,5"(Cell with number) = Conditional support with limitation (See notes at beginning of section) Blank Cell = Not supported		R1208 NVMe* WF							
		Classifications				A1	A2	A3	A4
ASHRAE (See note 1)	Max Ambient	15°C	20°C	25°C	27°C (1)	32°C	35°C	40°C	45°C
	Altitude	900	900	900	900	900	900	900	900
	Intel® Xeon® Gold 6242 CPU_16C	23	23	23	23				
	Intel® Xeon® Gold 6244 CPU_8C	23	23	23	23				
	Intel® Xeon® Gold 6210U CPU_20C	23	23	23	23				
140 W	Intel® Xeon® Gold 6238 CPU_22C	23	23	23	23	23	23		
135 W	Intel® Xeon® Gold 6262V CPU_24C	23	23	23	23	23	23		
130 W	Intel® Xeon® Silver 4215R CPU_8C	23	23	23	23	23	23		
	Intel® Xeon® Gold 6234 CPU_8C	23	23	23	23	23	23		
125 W	Intel® Xeon® Gold 5220R CPU_18C	23	23	23	23				
	Intel® Xeon® Gold 5218R CPU_20C	23	23	23	23				
	Intel® Xeon® Silver 4216R CPU_16C	23	23	23	23	23	23		
	Intel® Xeon® Gold 6238T CPU_22C	23	23	23	23	23	23		
	Intel® Xeon® Gold 6230T CPU_20C	23	23	23	23	23	23		
	Intel® Xeon® Gold 6230 CPU_20C	23	23	23	23	23	23		
	Intel® Xeon® Gold 6230N CPU_6/14C	23	23	23	23	23	23		
	Intel® Xeon® Gold 6209U CPU_20C	23	23	23	23	23	23		
	Intel® Xeon® Gold 5220S CPU_18C	23	23	23	23	23	23		
	Intel® Xeon® Gold 5220 CPU_18C	23	23	23	23	23	23		
	Intel® Xeon® Gold 5218 CPU_16C	23	23	23	23	23	23		
	Intel® Xeon® Gold 5218B CPU_16C	23	23	23	23	23	23		
	Intel® Xeon® Platinum 8253 CPU_16C	23	23	23	23	23	23		
	Intel® Xeon® Gold 6226 CPU_12C	23	23	23	23	23	23		

Intel® Server System R1000WF Product Family Technical Product Specification

<b>Thermal Config Matrix</b> <b>Fan Fail mode</b> "●"= Full support without limitation; "4,5"(Cell with number) = Conditional support with limitation (See notes at beginning of section) Blank Cell = Not supported		R1208 NVMe* WF								
		Classifications				A1	A2	A3	A4	
ASHRAE (See note 1)		Max Ambient	15°C	20°C	25°C	27°C (1)	32°C	35°C	40°C	45°C
		Altitude	900	900	900	900	900	900	900	900
115 W	Intel® Xeon® Gold 6222V CPU_20C	23	23	23	23					
	Intel® Xeon® Gold 5217 CPU_8C	23	23	23	23	23	23			
105 W	Intel® Xeon® Platinum 8256 CPU_4C	23	23	23	23	23	23			
	Intel® Xeon® Gold 5218N CPU_16/4/12C	23	23	23	23	23	23			
	Intel® Xeon® Gold 5220T CPU_18C	23	23	23	23	23	23			
	Intel® Xeon® Gold 5218T CPU_16C	23	23	23	23	23	23			
100 W	Intel® Xeon® Gold 5222 CPU_4C	23	23	23	23	23	23			
	Intel® Xeon® Silver 4216 CPU_16C	23	23	23	23	23	23	23		
	Intel® Xeon® Silver 4208R CPU_18C	23	23	23	23	23	23	23		
	Intel® Xeon® Silver 4210R CPU_10C	23	23	23	23	23	23	23		
	Intel® Xeon® Gold 5215R CPU_10C	23	23	23	23	23	23	23		
95 W	Intel® Xeon® Silver 4214R CPU_12C	23	23	23	23	23	23	23		
	Intel® Xeon® Silver 4210T CPU_10C	23	23	23	23	23	23	23		
85 W	Intel® Xeon® Gold 5215 CPU_10C	●	23	23	23	23	23	23	23	23
	Intel® Xeon® Silver 4214 CPU_12C	●	23	23	23	23	23	23	23	23
	Intel® Xeon® Silver 4214Y CPU_12/10/8C	●	23	23	23	23	23	23	23	23
	Intel® Xeon® Silver 4210 CPU_10C	●	23	23	23	23	23	23	23	23
	Intel® Xeon® Silver 4215 CPU_8C	●	23	23	23	23	23	23	23	23
	Intel® Xeon® Silver 4208 CPU_8C	●	23	23	23	23	23	23	23	23
	Intel® Xeon® Bronze 3204 CPU_6C	●	23	23	23	23	23	23	23	23
	Intel® Xeon® Bronze 3206R CPU_8C	●	23	23	23	23	23	23	23	23

<b>Thermal Config Matrix</b> <b>Fan Fail mode</b> "•"= Full support without limitation; "4,5"(Cell with number) = Conditional support with limitation (See notes at beginning of section) Blank Cell = Not supported		R1208 NVMe* WF							
		Classifications				A1	A2	A3	A4
ASHRAE (See note 1)	Max Ambient	15°C	20°C	25°C	27°C (1)	32°C	35°C	40°C	45°C
	Altitude	900	900	900	900	900	900	900	900
	70 W	Intel® Xeon® Silver 4209T CPU_8C	•	•	23	23	23	23	23
Memory Type	AEP SDP 128 GB	•	•	•	•	•	•	3	3
	AEP DDQ 256 GB	•	•	•	•	•	•	3	3
	AEP QDP 512 GB	•	•	•	•	3	3	3	3
	RDIMM-2Rx8, 1Rx4, 1Rx8	•	•	•	•	•	•	•	•
	RDIMM-DRx4	•	•	•	•	•	•	•	•
	LRDIMM-QRx4 DDP	•	•	•	•	3	3	3	3
Add-in Cards (See note 5)	Riser #1 - Bottom Slot (1U riser and 2U riser)	•	•	•	•	•	•	•	•
	Riser #2 - Bottom Slot (1U riser and 2U riser)	•	•	•	•	•	•	•	•
	Riser #3 - Bottom Slot								
	Riser #3 - Top Slot								
SAS and OCP Modules (See note 4)	Intel® Integrated RAID Modules (Mezzanine cards)	•	•	•	•	•	•	•	•
	16 port tri mode mezzanine	•	•	•	•	26	26	26	26
	IFT carrier AIC	26	26	26	26	26	26	26	26
	IFT carrier Mezzanine	26	26	26	26	26	26	26	26
	Dual 10GBase-T Taylor Canal	•	•	•	•	•	•	•	•
	Dual SFP+ Cascade Canal	•	•	•	•	12	12	13	14
	Quad SFP+ Cascade Canal	•	•	•	•	•	•	•	•
	1GBase-T Quad Main Canal	•	•	•	•	•	•	•	•
	BBU (rated to 45C)	•	•	•	•	•	•		

<b><u>Thermal Config Matrix</u></b> <b>Fan Fail mode</b> "•"= Full support without limitation; "4,5"(Cell with number) = Conditional support with limitation (See notes at beginning of section) Blank Cell = Not supported		R1208 NVMe* WF							
ASHRAE (See note 1)	Classifications					A1	A2	A3	A4
	Max Ambient	15°C	20°C	25°C	27°C (1)	32°C	35°C	40°C	45°C
	Altitude	900	900	900	900	900	900	900	900
Battery Backup (See note 9)	Supercap (rated to 55C)	•	•	•	•	•	•		
	Cache Offload Module (rated to 55C)	•	•	•	•	•	•	•	•
2.5" SFF NVMe* SSD (DC P3700/P3500) (See note 22)	1600GB/2TB	•	•	•	•	•	•	•	•
	800GB	•	•	•	•	•	•	•	•
	600GB	•	•	•	•	•	•	•	•
	400GB	•	•	•	•	•	•	•	•
	200GB	•	•	•	•	•	•	•	•
SATA HDD	Up to 2 TB	•	•	•	•	•	•	•	•
PCIe SSD AIC FF (DC P3700/P3500) (See note 8)	1600GB/2TB	•	•	•	•	•	•	•	•
	800GB	•	•	•	•	•	•	•	•
	600GB	•	•	•	•	•	•	•	•
	400GB	•	•	•	•	•	•	•	•
	200GB	•	•	•	•	•	•	•	•
M.2 Sustained Max Power (TDP)	Intel 120G and 80G SATA	•	•	•	•	13	13	13	13
	non-Intel M.2	•	•	•	•	15	15	15	15
M.2 Light Workload [See note 14]	Intel 120G and 80G SATA	•	•	•	•	13	13	13	13
	non-Intel M.2	•	•	•	•	15	15	15	15

## Appendix E. System Cable Routing Diagrams

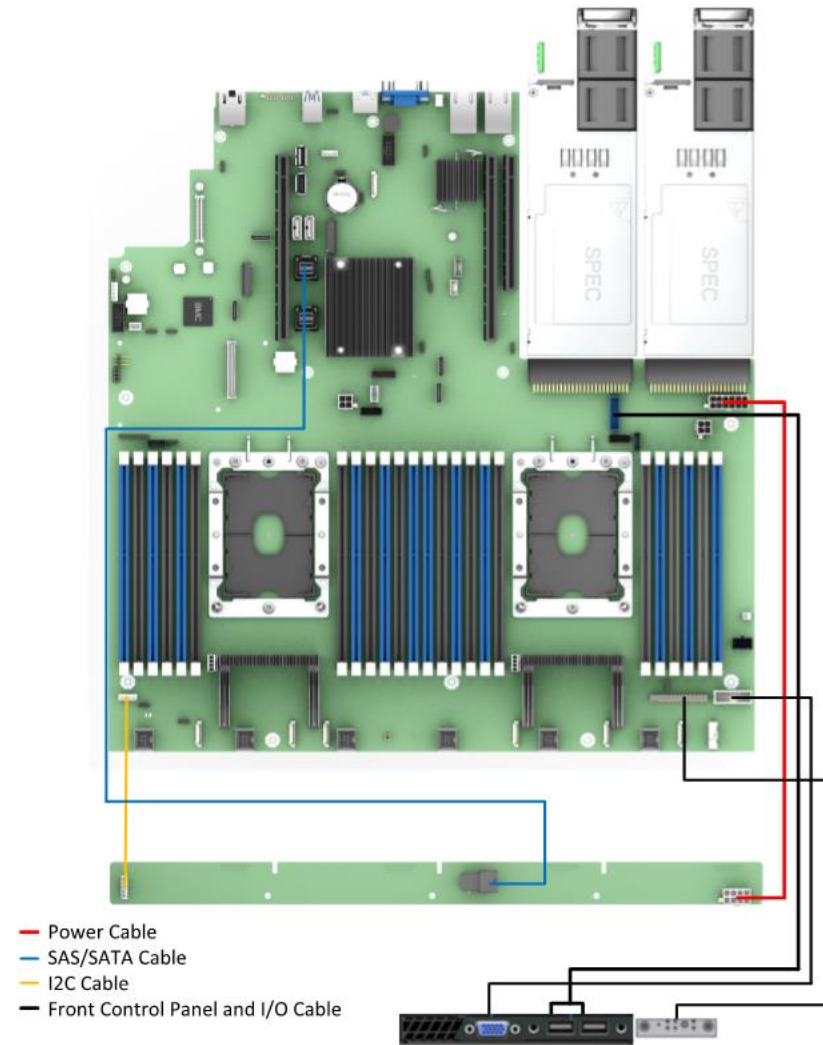
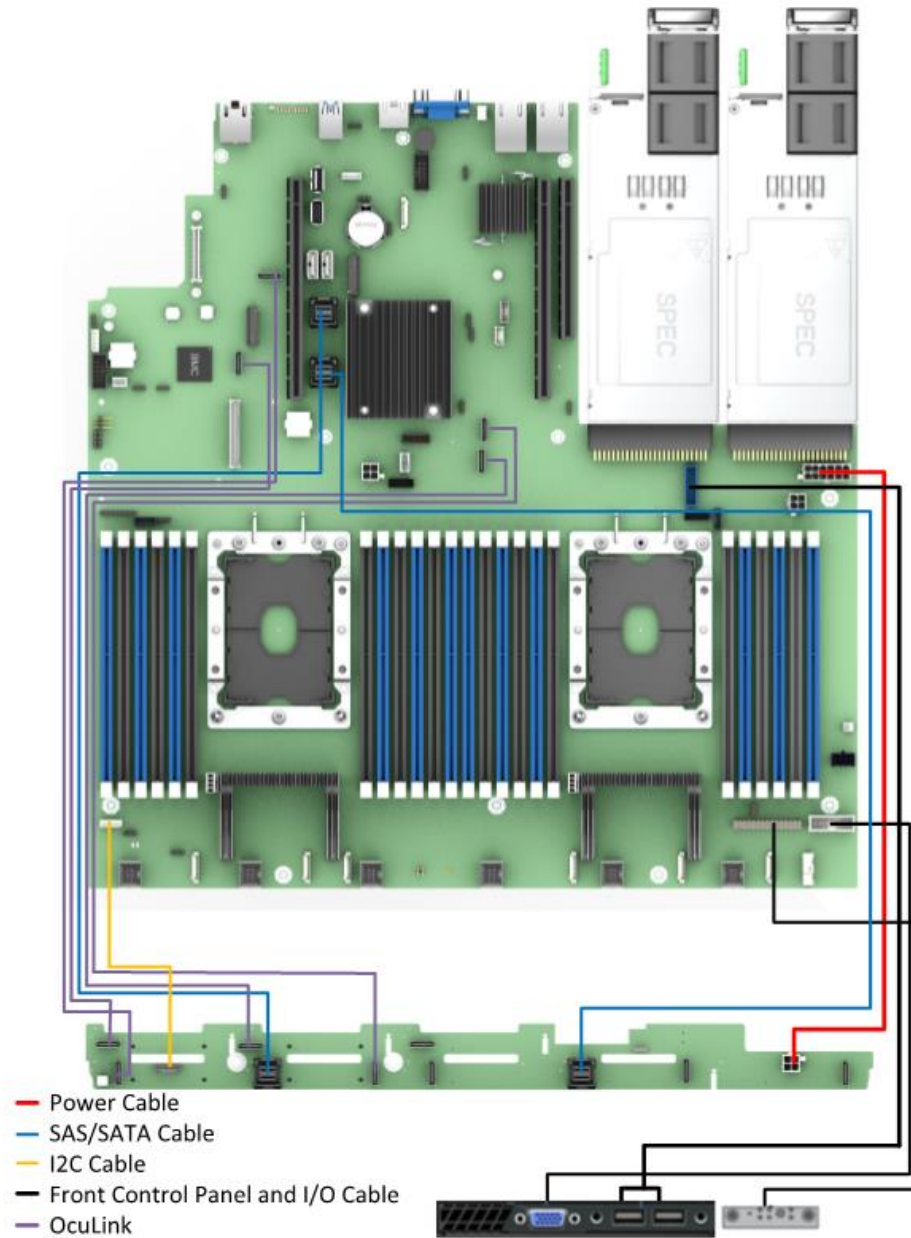


Figure 69. R1304WFxxx system cable routing diagram



**Figure 70. R1208WFxxx system cable routing diagram**



## Appendix F. Statement of Volatility

The tables in this section are used to identify the volatile and non-volatile memory components for system boards used within the Intel® Server System R2000WF product family.

The tables provide the following data for each identified component.

- **Component Type:** Three types of components are on the server board assembly:
  - **Non-volatile:** Non-volatile memory is persistent, and is not cleared when power is removed from the system. Non-volatile memory must be erased to clear data. The exact method of clearing these areas varies by the specific component. Some areas are required for normal operation of the server, and clearing these areas may render the server board inoperable
  - **Volatile:** Volatile memory is cleared automatically when power is removed from the system.
  - **Battery powered RAM:** Battery powered RAM is similar to volatile memory, but is powered by a battery on the server board. Data in battery powered RAM is persistent until the battery is removed from the server board.
- **Size:** Size of each component in bits, Kbits, Mbits, bytes, kilobytes (KB), or megabytes (MB).
- **Board Location:** Board location is the physical location of each component corresponding to information on the server board silkscreen.
- **User Data:** The flash components on the server boards do not store user data from the operating system. No operating system level data is retained in any listed components after AC power is removed. The persistence of information written to each component is determined by its type as described in the table.

Each component stores data specific to its function. Some components may contain passwords that provide access to that device's configuration or functionality. These passwords are specific to the device and are unique and unrelated to operating system passwords. The specific components that may contain password data are:

- **BIOS:** The server board BIOS provides the capability to prevent unauthorized users from configuring BIOS settings when a BIOS password is set. This password is stored in BIOS flash, and is only used to set BIOS configuration access restrictions.
- **BMC:** The server boards support an Intelligent Platform Management Interface (IPMI) 2.0 conformant baseboard management controller (BMC). The BMC provides health monitoring, alerting and remote power control capabilities for the Intel® Server Board. The BMC does not have access to operating system level data.

The BMC supports the capability for remote software to connect over the network and perform health monitoring and power control. This access can be configured to require authentication by a password. If configured, the BMC maintains user passwords to control this access. These passwords are stored in the BMC flash.

**Table 64. Intel® Server Board S2600WF (iPN – H48104-xxx)**

Component Type	Size	Board location	User Data	Name
Non-Volatile	64 MB	U3D1	No(BIOS)	BIOS Flash
Non-Volatile	64 MB	U1D1	No(FW)	BMC Flash
Non-Volatile	4 MB	U5M1	No	10GB NIC EEPROM (S2600WTTR)
Non-Volatile	N/A	U1E3	No	CPLD
Volatile	512 MB	U1D2	No	BMC firmware SDRAM
Non-Volatile	8 GB	U8N1	No	BMC eMMC

**Table 65. 1U 1-slot PCIe\* riser card (iPN – H39531-xxx)**

Component Type	Size	Board Location	User Data	Name
N/A	N/A	None	No	N/A

**Table 66. Front panel board (iPN – H29366-xxx)**

Component Type	Size	Board Location	User Data	Name
Non-Volatile	256x8	None	Yes	PSOC / Microcontroller

**Table 67. 1U 4 x 3.5" hot swap backplane option (iPN – G97162-XXX)**

Component Type	Size	Board Location	User Data	Name
Non-Volatile	16384x8	None	Yes	PSOC / Microcontroller / FRU
Non-Volatile	1024x8	None	No	SAS Re-Driver Settings

**Table 68. 1U 8 x 2.5" SAS hot swap backplane option (iPN – H88382-XXX)**

Component Type	Size	Board Location	User Data	Name
Non-Volatile	16384x8	None	Yes	PSOC / Microcontroller / FRU
Non-Volatile	1024x8	None	No	SAS Re-Driver Settings

**Table 69. Intel® Remote Management Module Lite accessory option (iPC – AXXRMM4LITE2)**

Component Type	Size	Board Location	User Data	Name
Non-Volatile	1Mbit	U2B1	No	RMM Programming

## Appendix G. Product Regulatory Information

This product has been evaluated and certified as Information Technology Equipment (ITE), which may be installed in offices, schools, computer rooms, and similar commercial type locations. The suitability of this product for other product certification categories and/or environments (such as: medical, industrial, telecommunications, NEBS, residential, alarm systems, test equipment, etc.), other than an ITE application, will require further evaluation and may require additional regulatory approvals.

Intel has verified that all L3, L6, and L9 server products<sup>1</sup> **as configured and sold by Intel** to its customers comply with the requirements for all regulatory certifications defined in the following table. It is the Intel customer's responsibility to ensure their final server system configurations are tested and certified to meet the regulatory requirements for the countries to which they plan to ship and or deploy server systems into.

	Intel® Server Board S2600WF Family	Intel® Server System R1000WF Family	Notes
	"Wolf Pass"	1U "Wolf Pass"	<b>Intel Project Code Name</b>
	<b>L3 Board</b>	<b>L6/L9 System</b>	<b>Product Integration Level</b>
<b>Regulatory Certification</b>	<b>S2600WF</b>	<b>Rr1000</b>	<b>Product family identified on certification</b>
RCM DoC Australia & New Zealand	✓	✓	
CB Certification & Report (International - report to include all CB country national deviations)	✓	✓	
China CCC Certification	○	●	Only applicable to select OEM defined SKUs
CU Certification (Russia/Belarus/Kazakhstan)	○	✓	
Europe CE Declaration of Conformity	✓	✓	
FCC Part 15 Emissions Verification (USA & Canada)	✓	✓	
Germany GS Certification	○	✓	
India BIS Certification	○	●	Only applicable to select OEM defined SKUs
International Compliance – CISPR32 & CISPR24	✓	✓	
Japan VCCI Certification	○	✓	
Korea KC Certification	✓	✓	
Mexico Certification	○	✓	
NRTL Certification (USA & Canada)	✓	✓	
South Africa Certification	○	✓	

<sup>1</sup> An L9 system configuration is a power-on ready server system with NO operating system installed.

An L6 system configuration requires additional components to be installed in order to make it power-on ready. L3 are component building block options that require integration into a chassis to create a functional server system.

	Intel® Server Board S2600WF Family	Intel® Server System R1000WF Family	Notes
	"Wolf Pass"	1U "Wolf Pass"	<b>Intel Project Code Name</b>
	<b>L3 Board</b>	<b>L6/L9 System</b>	<b>Product Integration Level</b>
<b>Regulatory Certification</b>	<b>S2600WF</b>	<b>Rr1000</b>	<b>Product family identified on certification</b>
Taiwan BSMI Certification	✓ (DOC)	✓	
Ukraine Certification	○	✓	
<b>Table Key</b>			
Not Tested / Not Certified		○	
Tested / Certified – Limited OEM SKUs only		●	
Testing / Certification (Planned)		(Date)	
Tested / Certified		✓	

## EU Directive 2019/424 (Lot 9)

Beginning on March 1, 2020, an additional component of the European Union (EU) regulatory CE marking scheme, identified as EU Directive 2019/424 (Lot 9), will go into effect. After this date, all new server systems shipped into or deployed within the EU must meet the full CE marking requirements including those defined by the additional EU Lot 9 regulations.

Intel has verified that all L3, L6, and L9 server products<sup>2</sup> **as configured and sold by Intel** to its customers comply with the full CE regulatory requirements for the given product type, including those defined by EU Lot 9. It is the Intel customer's responsibility to ensure their final server system configurations are Spec® SERT™ tested and meet the new CE regulatory requirements.

Visit the following website for additional EU Directive 2019/424 (Lot9) information:

<https://eur-lex.europa.eu/legal-content/EN/TXT/?uri=CELEX:32019R0424>

In compliance with the EU Directive 2019/424 (Lot 9) materials efficiency requirements, Intel makes available all necessary product collaterals as identified below:

- **Product Serviceability Instructions**
  - *Intel® Server System R1000WF Product Family System Integration and Service Guide*
  - <https://www.intel.com/content/www/us/en/support/products/89017/server-products/server-systems/intel-server-system-r1000wf-family.html>

<sup>2</sup> An L9 system configuration is a power-on ready server system with NO operating system installed.

An L6 system configuration requires additional components to be installed in order to make it power-on ready. L3 are component building block options that require integration into a chassis to create a functional server system

- **Product Specifications**

- *Intel® Server System R1000WF Product Family Technical Product Specification* (This document)
- *Intel® Server Board S2600WF Product Family Technical Product Specification*
- <https://www.intel.com/content/www/us/en/support/articles/000023750/server-products/server-boards.html>

- **System BIOS/Firmware and Security Updates – Intel® Server Board S2600WF family**

- System Update Package (SUP) – uEFI only
- Intel® One Boot Flash Update (OFU) – Various OS Support
- <https://www.intel.com/content/www/us/en/support/products/89017/server-products/server-systems/intel-server-system-r1000wf-family.html>

- **Intel Solid State Drive (SSD) Secure Data Deletion and Firmware Updates**

- **Note:** For system configurations that may be configured with an Intel SSD
- Intel® Solid State Drive Toolbox
- <https://downloadcenter.intel.com/download/29205?v=t>

- **Intel® RAID Controller Firmware Updates and other support collaterals**

- **Note:** For system configurations that may be configured with an Intel® RAID Controller
- <https://www.intel.com/content/www/us/en/support/products/43732/server-products/raid-products.html>

**EU Directive 2019/424 (Lot 9) – Support Summary****Rr1000 – Intel® Server System R1000WF Family (Wolf Pass)**

**DISCLAIMER** – The information contained within this document is for reference only and is intended to provide customers with a template to report information needed for (EU) 2019/424 (Lot 9) server conformity assessment. The information provided herein does not represent any final shipping server system test results, and customer's actual test results for shipping server configurations may differ from this list. Use of this information is at the sole risk of the user, and Intel assumes no responsibility for customers server system level regulation compliance to EU 2019/424 (Lot 9).

<b>Product Information</b>																					
Product Type	Server																				
Manufacturer Name	Intel Corporation																				
Registered trade name and address	Intel 2200 Mission College Blvd Santa Clara, CA 95054-1594, USA																				
Product model number and model numbers for low end performance and high-end performance configure if applicable	Rr1000																				
Year of Launch	2017																				
PSU efficiency at 10%, 20%, 50% and 100% of rated output power	AXX1100PCRPS (S-1100ADU00-201) – 1100W AC (Platinum) AXX1300TCRPS (PSSF132202A) – 1300W AC (Titanium) AXX750DCCRPS (DPS-750AB-32) – 750W DC (Gold) <table border="1" data-bbox="1150 829 1885 959"> <thead> <tr> <th>Model</th> <th>100%</th> <th>50%</th> <th>20%</th> <th>10%</th> </tr> </thead> <tbody> <tr> <td>S-1100ADU00-201</td> <td>91%</td> <td>94%</td> <td>90%</td> <td>82%</td> </tr> <tr> <td>PSSF132202A</td> <td>91%</td> <td>96%</td> <td>94%</td> <td>90%</td> </tr> <tr> <td>DPS-750AB-32</td> <td>88%</td> <td>92%</td> <td>88%</td> <td>80%</td> </tr> </tbody> </table>	Model	100%	50%	20%	10%	S-1100ADU00-201	91%	94%	90%	82%	PSSF132202A	91%	96%	94%	90%	DPS-750AB-32	88%	92%	88%	80%
Model	100%	50%	20%	10%																	
S-1100ADU00-201	91%	94%	90%	82%																	
PSSF132202A	91%	96%	94%	90%																	
DPS-750AB-32	88%	92%	88%	80%																	
PSU factor at 50% of rated load level	AXX1100PCRPS: >0.90 AXX1300TCRPS: >0.98																				
PSU Rated Power Output (Server Only)	AXX1100PCRPS: 1100W AXX1300TCRPS: 1300W AXX750DCCRPS: 750W																				
Idle state power (Server only) (Watts)	Refer to the following table																				
List of all components for additional idle power allowances (server only)	Refer to the following table																				
Maximum power (Server only)	Refer to the following table																				
Declared operating condition class ** Refer to <i>Appendix D - System Configuration Table for Thermal Compatibility</i> for specific ASHRAE support by system configuration	<ul style="list-style-type: none"> <li>ASHRAE Class A2-Continuous Operation 10 °C to 35 °C with the maximum rate of change not to exceed 10 °C per hour</li> <li>ASHRAE Class A3 – Includes operation up to 40°C for up to 900 hours per year</li> <li>ASHRA Class A4 - Includes operation up to 45°C for up to 90 hours per year</li> </ul>																				
Idle State Power (watts) at the higher boundary temp (Server Only)	Refer to the following table																				
the active state efficiency and the performance in active state of the server (server only)	Refer to the following table																				

**Product Information**

Information on the secure data deletion functionality	Refer to the following table
for blade server, a list of recommended combinations with compatible chassis (Server only)	Not Applicable
If Product Model Is Part Of A Server Product Family, a list of all model configurations that are represented by the model shall be supplied (Server only)	Not Applicable

## Energy Efficiency Data of Rr1000 – 1 (Single) CPU Installed Configuration

Configuration				
			1-CPU Low-end config.	1-CPU High-end Config.
Details	Chassis	Model	R1208WFTYSR	R1208WFTYSR
	Node / Motherboard (MB)	# of MBs installed in system	1	1
		Model	S2600WFTR	S2600WFTR
	Processor	# of Processors per MB	1	1
		Processor Model	Intel® Xeon® Scalable Bronze 3104	Intel® Xeon® Scalable Platinum 8276L
	Memory	# of DIMMs installed per MB	6 (1 DIMM / Mem. Channel)	6 (1 DIMM / Mem. Channel)
		Capacity per DIMM (GB)	64 GB	128 GB
		Total Memory (GB) per node / MB	384 GB	768 GB
	SSD	Total # of SSDs installed	2	2
	Power Supply (PSU)	Total # of PSU installed	1	1
		Model	AXX1300TCRPS – 1300W PSSF132202A	AXX1300TCRPS – 1300W PSSF132202A
Chassis				
System Software Revisions installed to each Node or MB			BIOS: SE5C620.86B.02.01.0009 BMC: 2.22.59c3b83a FRU: 1.96	
<b>Data Summary</b>				
Measured and Calculated Server Allowance	P Base		25.0	25
	Additional CPU		9.3	78.0
	Additional Power Supply		0.0	0.0
	Storage Devices		10.0	10.0
	Additional Memory		68.4	137.5
	Additional I/O Device (10Gx 15W/2Port on MB)		2.0	2.0
	Perfcpu		0.93	7.80
Limits/ Results	Idle power allowances (W)		114.7	252.5
	Idle power tested (W) Per node		95.1	102.3
	Minimum Eff <sub>ACTIVE</sub>		9.0	9.0
	Eff <sub>ACTIVE</sub> tested		9.6	29.4
Other test result	Idle Power at Higher Temp. (per Node) @ 35 degree C		112.9 W	116.7 W
	Max Power (Per Node)		183.6 W	342.9 W



## Energy Efficiency Data of Rr1000 – 2 (Dual) CPU Installed Configuration

Configuration				
			2-CPU Low-end	2-CPU High-end
Details	Chassis	Model	<b>R1208WFTYSR</b>	<b>R1208WFTYSR</b>
	Node / Motherboard (MB)	# of MBs installed in system	<b>1</b>	<b>1</b>
		Model	<b>S2600WFTR</b>	<b>S2600WFTR</b>
	Processor	# of Processors per MB	<b>2</b>	<b>2</b>
		Processor Model	<b>Intel® Xeon® Scalable Bronze 3104</b>	<b>Intel® Xeon® Scalable Platinum 8276L</b>
	Memory	# of DIMMs installed per node / MB	<b>12 total = 6 per CPU</b> (1 DIMM / Mem. Channel)	<b>12 total = 6 per CPU</b> (1 DIMM / Mem. Channel)
		Capacity per DIMM (GB)	<b>16 GB</b>	<b>128 GB</b>
		Total Memory (GB) per node / MB	<b>384 GB</b>	<b>1536 GB</b>
	SSD	Total # of SSDs installed	<b>2</b>	<b>2</b>
	Power Supply (PSU)	Total # of PSU installed	<b>2</b>	<b>2</b>
Model		<b>AXX1300TCRPS – 1300W</b> PSSF132202A	<b>AXX1300TCRPS – 1300W</b> PSSF132202A	
Chassis	System Software Revisions installed to each Node or MB			
			<b>BIOS: SE5C620.86B.02.01.0009</b>	
			<b>BMC: 2.22.59c3b83a</b>	
			<b>FRU: 1.96</b>	
Data Summary				
Measured and Calculated Server Allowance	P Base		<b>38.0</b>	<b>38.0</b>
	Additional CPU		<b>12.6</b>	<b>106.4</b>
	Additional Power Supply		<b>10.0</b>	<b>10</b>
	Storage Devices		<b>10.0</b>	<b>10</b>
	Additional Memory		<b>33.8</b>	<b>275.8</b>
	Additional I/O Device (10Gx 15W/2Port on MB)		<b>2.0</b>	<b>2</b>
	Perfcpu		<b>1.80</b>	<b>15.2</b>
Limits/ Results	Idle power allowances (W)		<b>106.4</b>	<b>442.2</b>
	Idle power tested (W) Per node		<b>106.1</b>	<b>136.3</b>
	Minimum Eff <sub>ACTIVE</sub>		<b>9.5</b>	<b>9.5</b>
	Eff <sub>ACTIVE</sub> tested		<b>13.6</b>	<b>33.0</b>
Other test result	Idle Power at Higher Temp. (per Node) @ 35 degree C		<b>128.0W</b>	<b>95.1W</b>
	Max Power (Per Node)		<b>220.5W</b>	<b>160.1W</b>

**Other Information:**

**Chemical Declaration**

- Neodymium Not Applicable. (No HDD offered by Intel)
- Cobalt Not Applicable. (No BBUs. Coin battery is out of scope)

## Appendix H. Glossary

Term	Definition
<b>BMC</b>	Baseboard Management Controller
<b>BIOS</b>	Basic Input/Output System
<b>CMOS</b>	Complementary Metal-oxide-semiconductor
<b>CPU</b>	Central Processing Unit
<b>DDR4</b>	Double Data Rate 4th edition
<b>DIMM</b>	Dual In-line Memory Module
<b>DPC</b>	DIMMs per Channel
<b>EDS</b>	External Design Specification
<b>EPS</b>	External Product Specification
<b>FP</b>	Front Panel
<b>FRB</b>	Fault Resilient Boot
<b>FRU</b>	Field Replaceable Unit
<b>GPGPU</b>	General Purpose Graphic Processing Unit
<b>I2C</b>	Inter-integrated Circuit bus
<b>iPC</b>	Intel Product Code
<b>LED</b>	Light Emitting Diode
<b>LFM</b>	Linear Feet per Minute – Airflow measurement
<b>LPC</b>	Low-pin Count
<b>LRDIMM</b>	Load Reduced DIMM
<b>LSB</b>	Least Significant Bit
<b>MSB</b>	Most Significant Bit
<b>MTBF</b>	Mean Time Between Failure
<b>NIC</b>	Network Interface Card
<b>NMI</b>	Non-maskable Interrupt
<b>OCuLink*</b>	Optical Copper Link*
<b>OVP</b>	Over-voltage Protection
<b>PCI</b>	Peripheral Component Interconnect
<b>PCB</b>	Printed Circuit Board
<b>PCIe*</b>	Peripheral Component Interconnect Express*
<b>PCI-X</b>	Peripheral Component Interconnect Extended
<b>PFC</b>	Power Factor Correction
<b>PMM</b>	Persistent Memory Module

Term	Definition
<b>POST</b>	Power-on self-test
<b>PSU</b>	Power Supply Unit
<b>RAID</b>	Redundant Array of Independent Disks
<b>RAM</b>	Random Access Memory
<b>RDIMM</b>	Registered DIMM
<b>ROC</b>	RAID On Chip
<b>SAS</b>	Serial Attached SCSI
<b>SATA</b>	Serial Advanced Technology Attachment
<b>SCA</b>	Single Connector Attachment
<b>SCSI</b>	Small Computer System Interface
<b>SDR</b>	Sensor Data Record
<b>SSD</b>	Solid State Device
<b>TPM</b>	Trusted Platform Module
<b>TPS</b>	Technical Product Specification
<b>Intel® TXT</b>	Intel® Trusted Execution Technology
<b>VLSI</b>	Very Large Scale Integration
<b>VSB</b>	Voltage Standby
<b>Intel® VROC</b>	Intel® Virtual RAID on CPU